



## **Project Manual**

for the

# **LIBERTY HIGH SCHOOL Administration and Student Commons Modernization**

December 3, 2020

**DSA File Number: 7-H4**  
**DSA Application Number: 01-119033**  
**PTN Number: 61721-55**

**Owner:**

Liberty Union High School District  
20 Oak Street  
Brentwood, CA

**Architect:**

Quattrocchi Kwok Architects  
636 Fifth Street  
Santa Rosa, CA 95404  
P: 707.576.0829  
F: 707.576.0295

**Architect's Project No.: 1783.00**

DOCUMENT 00 0107

PROFESSIONAL SEALS AND DSA IDENTIFICATION STAMP

DIVISION OF THE STATE ARCHITECT IDENTIFICATION STAMP

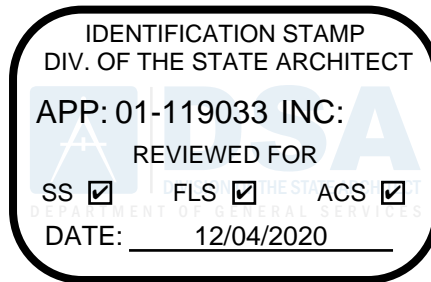

Date: 11/19/2020

**Architect**

QUATTROCCHI KWOK ARCHITECTS  
636 Fifth Street  
Santa Rosa, CA 95404  
P: 707-576-0829  
Jim Theiss  
Lic: C 22643



**Civil Engineer**

CARLSON BARBEE & GIBSON  
2633 Camino Ramon, Ste. 350  
San Ramon, CA 94583  
P: 925-866-0322  
Jason Vogan  
Lic: 59299



NOV 18 2020

**Structural Engineer**  
ZFA

1212 Fourth Street, Suite Z  
Santa Rosa, CA 95404  
P: 707-526-0992  
Chris Warner  
Lic: S4613

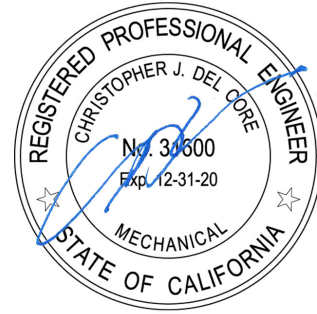

**Mechanical Engineer**  
COSTA ENGINEERS

3274 Villa Lane  
Napa, Ca. 94558  
P: 707-252-9177  
Chris DelCore  
Lic: M31600



**Electrical Engineer**

O'MAHONY & MYER  
4340 Redwood Hwy., Suite 245  
San Rafael, CA 94903  
P: 415-492-0420  
Pieter Colenbrander  
Lic: E14738



**Landscape Architect**

GSM LANDSCAPE ARCHITECTS, INC  
1700 Soscol Avenue, Suite 23  
Napa, CA 94559  
P: 707-255-4630  
Gretchen Stranzl McCann  
Lic: 2790



Raymond D. Cole  
Fire Protection Engineer  
AXIOM ENGINEERS  
22 Lower Ragsdale Dr, Suite A  
Monterrey, CA 93940  
P: 831-649-8000

END OF SECTION

DOCUMENT 00 0110

**TABLE OF CONTENTS**

00 0101 - COVER  
00 0107 - PROFESSIONAL SEALS AND DSA IDENTIFICATION STAMP  
00 0110 - TABLE OF CONTENTS  
00 0115 - LIST OF DRAWINGS  
00 3100 - INFORMATION AVAILABLE TO BIDDERS

**DIVISION 00 PROCUREMENT AND CONTRACTING REQUIREMENTS**

LIBERTY UNION HIGH SCHOOL BIDDING DOCUMENTS FOR ADMINISTRATION AND  
STUDENT COMMONS AT LIBERTY HIGH SCHOOL  
00 7000 - GENERAL CONDITIONS  
00 7300 - SUPPLEMENTAL GENERAL CONDITIONS

**TECHNICAL SPECIFICATIONS**

**DIVISION 01 - GENERAL REQUIREMENTS**

01 1100 - SUMMARY OF WORK  
01 2600 - MODIFICATION PROCEDURES  
01 2900 - APPLICATIONS FOR PAYMENT  
01 3200 - CONSTRUCTION PROGRESS SCHEDULE  
01 3300 - SUBMITTALS  
01 3546 - CONSTRUCTION INDOOR AIR QUALITY PLAN  
01 3900 - COORDINATION AND MEETINGS  
01 4000 - QUALITY CONTROL  
01 4200 - REFERENCE STANDARDS  
01 4523 - TESTING AND INSPECTION SERVICES  
01 5000 - TEMPORARY FACILITIES  
01 5600 - TEMPORARY CONTROLS  
01 6000 - PRODUCT REQUIREMENTS  
01 6116 - VOLATILE ORGANIC COMPOUND RESTRICTIONS  
01 6116.01 - ACCESSORY MATERIAL VOC CONTENT CERTIFICATION FORM  
01 7000 - CONTRACT CLOSEOUT  
01 7419 - CONSTRUCTION WASTE MANAGEMENT  
01 7500 - STARTING OF SYSTEMS  
01 7513 - EXECUTION REQUIREMENTS  
01 8113 - SUSTAINABLE DESIGN REQUIREMENTS  
01 8122 - ACOUSTICAL PERFORMANCE REQUIREMENTS  
01 8123 - NOISE AND VIBRATION CONTROL

**DIVISION 02 - EXISTING CONDITIONS**

02 4116 - BUILDING DEMOLITION  
02 4119 - MINOR DEMOLITION FOR REMODELING

**DIVISION 03 - CONCRETE**

03 1000 - CONCRETE FORMING AND ACCESSORIES  
03 2000 - CONCRETE REINFORCING  
03 3000 - CAST-IN-PLACE CONCRETE  
03 3511 - CONCRETE FLOOR FINISHES  
03 3543 - POLISHED CONCRETE FINISHING

**DIVISION 04 - MASONRY**

04 2000 - CONCRETE UNIT MASONRY

**DIVISION 05 - METALS**

05 1100 - STRUCTURAL AND MISCELLANEOUS STEEL  
05 3000 - METAL DECKING  
05 4000 - COLD-FORMED METAL FRAMING  
05 5000 - METAL FABRICATIONS  
05 5133 - ACCESS LADDERS  
05 7000 - DECORATIVE METAL

**DIVISION 06 - WOOD, PLASTICS AND COMPOSITES**

06 1000 - ROUGH CARPENTRY  
06 1733 - WOOD I-JOISTS  
06 2000 - FINISH CARPENTRY  
06 4100 - WOOD CASEWORK  
06 8316 - FIBERGLASS REINFORCED PANELING

**DIVISION 07 - THERMAL AND MOISTURE PROTECTION**

07 0150.19 - PREPARATION FOR RE-ROOFING  
07 2100 - BOARD AND BATT [BUILDING] INSULATION  
07 2216 - ROOF INSULATION  
07 2500 - WEATHER BARRIERS  
07 2633 - WATER VAPOR EMISSION CONTROL  
07 4113 - METAL ROOF PANEL  
07 4150 - METAL WALL PANELS  
07 5550 - MODIFIED BITUMEN ROOFING  
07 6200 - SHEET METAL FLASHING AND TRIM  
07 7100 - ROOF SPECIALTIES  
07 7200 - ROOF ACCESSORIES  
07 8400 - FIRESTOPPING  
07 9200 - JOINT SEALANTS  
07 9513 - EXPANSION JOINT COVER ASSEMBLIES

**DIVISION 08 - OPENINGS**

08 1113 - HOLLOW METAL DOORS AND FRAMES  
08 1416 - FLUSH WOOD DOORS  
08 3100 - ACCESS DOORS AND PANELS  
08 3613 - OVERHEAD SECTIONAL DOORS  
08 4313 - ALUMINUM ENTRANCES AND STOREFRONTS  
08 4413 - ALUMINUM CURTAIN WALL  
08 5113 - ALUMINUM WINDOWS  
08 5600 - SPECIAL WINDOWS  
08 6223 - TUBULAR SKYLIGHTS  
08 7100 - DOOR HARDWARE  
08 7100.1 - DOOR HARDWARE CUT SHEETS  
08 8000 - GLAZING  
08 9100 - LOUVERS

**DIVISION 09 - FINISHES**

09 0511 - CONCRETE FLOOR PREPARATION  
09 0512 - CONCRETE FLOOR MOISTURE CONTENT AND PH TESTING  
09 2116 - GYPSUM BOARD ASSEMBLIES  
09 2513 - ACRYLIC MODIFIED PORTLAND CEMENT PLASTER  
09 3000 - TILING  
09 5100 - ACOUSTICAL CEILINGS  
09 5133 - METAL ACOUSTICAL CEILING  
09 6500 - RESILIENT FLOORING  
09 6556 - SLIP RESISTANT RESILIENT FLOORING  
09 6813 - TILE CARPETING  
09 6770 - FLUID-APPLIED CORK FLOORING  
09 7230 - TACKABLE WALL COVERING  
09 7723 - WALL PANELS  
09 8420 - WOOD FIBER ACOUSTICAL WALL PANELS  
09 8430 - SOUND-ABSORBING WALL AND CEILING UNITS  
09 8448 - METAL-FACED ACOUSTICAL PANELS  
09 9113 - EXTERIOR PAINTING  
09 9123 - INTERIOR PAINTING  
09 9623 - ANTI-GRAFFITI COATINGS

**DIVISION 10 - SPECIALTIES**

10 0610 - EXTERIOR SIGNAGE  
10 1101 - VISUAL DISPLAY UNITS  
10 1400 - SIGNAGE  
10 2800- TOILET ACCESSORIES  
10 4400 - FIRE PROTECTION SPECIALTIES  
10 5113 - METAL LOCKERS  
10 5626 - MOBILE STORAGE SHELVING

**DIVISION 11 - EQUIPMENT**

11 4000 - FOOD SERVICE EQUIPMENT  
11 5200 - AUDIO-VISUAL EQUIPMENT

**DIVISION 12 - FURNISHINGS**

12 2100 - WINDOW SHADE SYSTEM  
12 3600 - COUNTERTOPS  
12 9300 - SITE FURNISHINGS

**DIVISION 13 - SPECIAL CONSTRUCTION**

13 4713 - CATHODIC PROTECTION SYSTEM

**DIVISION 14 - CONVEYING EQUIPMENT**

NOT USED

**DIVISION 15 THROUGH DIVISION 20**

NOT USED

**DIVISION 21 - FIRE SUPPRESSION**

21 0000 - FIRE PROTECTION GENERAL  
21 0500 - OVERHEAD FIRE PROTECTION  
21 1000 - UNDERGROUND FIRE SERVICE

**DIVISION 22 - PLUMBING**

22 0000 - PLUMBING  
22 1100 - SITE WATER DISTRIBUTION

**DIVISION 23 - HEATING VENTILATING AND AIR CONDITIONING (HVAC)**

23 0000 - HVAC  
23 0500 - GENERAL MECHANICAL  
23 0593 - TESTING AND BALANCING FOR HVAC  
23 0923 - CONTROLS

**DIVISION 25 - INTEGRATED AUTOMATION**

NOT USED



**DIVISION 26 - ELECTRICAL**

26 0500 - BASIC ELECTRICAL REQUIREMENTS  
26 0800 - TESTING  
26 2400 - SERVICE & DISTRIBUTION SYSTEM  
26 2700 - BASIC ELECTRICAL MATERIALS & METHODS  
26 5101 - LIGHTING  
26 5601 - SITE LIGHTING  
26 5708 - LOW VOLTAGE NETWORK LIGHTING CONTROL SYSTEM

**DIVISION 27 - COMMUNICATIONS**

27 0000 - TELECOMMUNICATIONS SYSTEM  
27 5103 - ASSISTED LISTENING SYSTEM

**DIVISION 28 - ELECTRONIC SAFETY AND SECURITY**

28 3100 - FIRE ALARM SYSTEM WITH VOICE EVACUATION

**DIVISION 31- EARTHWORK**

31 1000 - SITE CLEARING  
31 2000 - EARTHWORK  
31 2313 - SUBGRADE PREPARATION  
31 2333 - TRENCHING AND BACKFILL

**DIVISION 32- EXTERIOR IMPROVEMENTS**

32 1216 - ASPHALT CONCRETE PAVING  
32 1313 - CONCRETE PAVING  
32 1723 - PAVEMENT MARKINGS  
32 3119 - ORNAMENTAL FENCES AND GATES  
32 3121 - DOUBLE HEAVY-DUTY SWING GATE  
32 8000 - IRRIGATION SYSTEM  
32 9000 - LANDSCAPE PLANTING

**DIVISION 33 - UTILITIES**

33 3100 - SITE SANITARY SEWER  
33 4000 - SITE STORM DRAINAGE

**DIVISION 34 - 48 NOT USED**

END OF TABLE OF CONTENTS

**DOCUMENT 00 0115 - LIST OF DRAWINGS**

**PROJECT INFORMATION**

G-0.1	COVER SHEET
G-0.2	ABBREVIATIONS AND NOTES
G-0.3	FIRE AUTHORITY APPROVAL PLAN
G-0.4	ACCESSIBILITY PLAN
G-0.5	CODE ANALYSIS PLAN

**CIVIL**

C-1.0	EXISTING CONDITIONS/DEMOLITION
C-2.0	HORIZONTAL CONTROL
C-2.1	HORIZONTAL CONTROL
C-3.0	CURB AND WALL TYPE PLAN
C-3.1	CURB / WALL TYPE DETAILS
C-4.0	UTILITY PLAN
C-5.0	OVERALL GRADING AND DRAINAGE
C-5.1	GRADING AND DRAINAGE
C-5.2	GRADING AND DRAINAGE
C-5.3	GRADING AND DRAINAGE
C-6.0	SIGNING AND STRIPING PLAN
C-7.0	STORMWATER CONTROL PLAN
C-8.0	EROSION CONTROL PLAN

**LANDSCAPE**

L1.0	MATERIAL AND DETAIL REFERENCE PLAN
L1.1	CONSTRUCTION DETAILS
L1.2	CONSTRUCTION DETAILS
L1.3	CONSTRUCTION DETAILS
L1.4	CONSTRUCTION DETAILS
L2.0	LAYOUT PLAN
L3.0	IRRIGATION MAIN LINE, SLEEVE & WIRE PLAN
L3.1	IRRIGATION PLAN
L3.2	IRRIGATION LEGEND & NOTES
L3.3	IRRIGATION DETAILS
L3.4	IRRIGATION DETAILS
L3.5	IRRIGATION DETAILS
L3.6	IRRIGATION DETAILS & SCHEDULES
L4.0	PLANTING PLAN
L4.1	PLANTING DETAILS

**ARCHITECTURAL**

A-1.1	CAMPUS SITE PLAN
A-1.2	SITE DETAILS

BUILDING "A" - ADMINISTRATION BUILDING

A-A2.1	ADMINISTRATION AND A-WING BUILDINGS FLOOR PLAN
A-A2.2	ADMINISTRATION BUILDING DIMENSION PLAN
A-A2.3	ADMINISTRATION BUILDING FINISH PLAN - INTERIOR
A-A3.1	ADMINISTRATION BUILDING REFLECTED CEILING PLAN
A-A4.1	ADMINISTRATION BUILDING ROOF PLAN
A-A5.1	ADMINISTRATION BUILDING EXTERIOR ELEVATIONS
A-A6.1	ADMINISTRATION BUILDING SECTIONS
A-A6.2	ADMINISTRATION BUILDING WALL SECTIONS
A-A6.3	ADMINISTRATION BUILDING WALL SECTIONS
A-A7.1	ADMINISTRATION BUILDING INTERIOR ELEVATIONS
A-A7.2	ADMINISTRATION BUILDING INTERIOR ELEVATIONS
A-A7.3	ADMINISTRATION BUILDING INTERIOR ELEVATIONS
A-A7.4	ADMINISTRATION BUILDING INTERIOR ELEVATIONS
A-A7.5	ADMINISTRATION BUILDING INTERIOR ELEVATIONS
A-A7.6	ADMINISTRATION BUILDING INTERIOR ELEVATIONS
A-A7.7	ADMINISTRATION BUILDING INTERIOR ELEVATIONS

BUILDING "B" - CAFETERIA AND SERVERY

A-B2.0	CAFETERIA AND A-WING BUILDINGS DEMOLITION FLOOR PLAN
A-B2.1	CAFETERIA BUILDING FLOOR AND DIMENSION PLANS
A-B2.2	CAFETERIA BUILDING FINISH PLAN - INTERIOR
A-B3.1	CAFETERIA BUILDING REFLECTED CEILING PLAN
A-B4.1	CAFETERIA BUILDING ROOF PLAN
A-B5.1	CAFETERIA BUILDING EXTERIOR ELEVATIONS
A-B6.1	CAFETERIA BUILDING SECTIONS
A-B6.2	CAFETERIA BUILDING SECTIONS
A-B6.3	CAFETERIA BUILDING WALL SECTIONS
A-B6.4	CAFETERIA BUILDING WALL SECTIONS
A-B6.5	CAFETERIA BUILDING WALL SECTIONS
A-B6.6	CAFETERIA BUILDING WALL SECTIONS
A-B6.7	CAFETERIA BUILDING WALL SECTIONS
A-B7.1	CAFETERIA BUILDING INTERIOR ELEVATIONS
A-B7.2	CAFETERIA BUILDING INTERIOR ELEVATIONS
A-B7.3	CAFETERIA BUILDING INTERIOR ELEVATIONS
A-8.1	DOOR SCHEDULE
A-8.2	WINDOW SCHEDULE
A-8.3	WINDOW SCHEDULE
A-9.1	WALL DETAILS
A-9.2	FRAMING DETAILS
A-9.3	OPENING DETAILS
A-9.4	ROOFING DETAILS
A-9.5	ROOFING DETAILS
A-9.6	RAIN CANOPIES AND METAL PANEL DETAILS
A-10.1	CEILING DETAILS

A-10.2 INTERIOR DETAILS  
A-10.3 INTERIOR AND CASEWORK DETAILS  
A-10.4 CASEWORK DETAILS

AG-2.1 ARCH GRAPHICS PLAN

## **STRUCTURAL**

S-0.1 GENERAL NOTES  
S-1.1 TYPICAL CONCRETE DETAILS  
S-1.2 TYPICAL WOOD DETAILS  
S-1.3 TYPICAL WOOD DETAILS  
S-1.4 TYPICAL I-JOIST DETAILS  
S-1.5 TYPICAL CMU DETAILS  
S-A2.1 ADMINISTRATION BUILDING FOUNDATION PLAN  
S-A2.2 ADMINISTRATION BUILDING ROOF FRAMING PLAN  
S-B2.1 CAFETERIA FOUNDATION PLAN  
S-B2.2 CAFETERIA ROOF FRAMING PLAN  
S-3.1 CANOPY PLANS  
S-4.1 FOUNDATION DETAILS  
S-5.1 STEEL DETAILS  
S-6.1 WOOD DETAILS  
S-7.1 RAIN CANOPY DETAILS  
S-8.1 MODERNIZATION DETAILS  
S-8.2 MODERNIZATION DETAILS

## **MECHANICAL**

M-1.1 MECHANICAL SCHEDULES & LEGENDS  
M-A2.0 ADMINISTRATION DEMOLITION MECHANICAL PLAN  
M-B2.0 CAFETERIA MECHANICAL DEMOLITION FLOOR PLAN  
M-B4.0 CAFETERIA MECHANICAL DEMO ROOF PLAN  
M-A2.1 ADMINISTRATION MECHANICAL FLOOR PLAN  
M-A4.1 ADMINISTRATION MECHANICAL ROOF PLAN  
M-B2.1 CAFETERIA MECHANICAL FLOOR PLAN  
M-B3.1 CAFETERIA MECHANICAL KITCHEN ENLARGEMENT  
M-B4.1 CAFETERIA MECHANICAL ROOF PLAN  
M-5.1 MECHANICAL DETAILS  
M-5.2 MECHANICAL DETAILS  
M-5.3 MECHANICAL DETAILS  
M-6.1 CONTROL DIAGRAMS  
M-6.2 CONTROL DIAGRAMS  
M-6.3 PIPING DIAGRAMS

## **PLUMBING**

P-1.1 PLUMBING SCHEDULES & LEGENDS  
P-A2.0 ADMINISTRATION DEMOLITION PLUMBING PLAN  
P-B2.0 CAFETERIA PLUMBING DEMOLITION FLOOR PLAN  
P-B3.0 CAFETERIA DEMOLITION ENLARGEMENT PLANS  
P-B4.0 CAFETERIA ROOF DEMOLITION PLAN

P-B2.1	CAFETERIA PLUMBING FLOOR PLAN
P-A2.1	ADMINISTRATION PLUMBING WASTE & VENT PLAN
P-A2.2	ADMINISTRATION PLUMBING WATER PLAN
P-A4.1	ADMINISTRATION PLUMBING ROOF PLAN
P-B3.1	CAFETERIA WASTE & VENT KITCHEN ENLARGEMENT
P-B3.2	CAFETERIA WATER & GAS KITCHEN ENLARGEMENT
P-B4.1	CAFETERIA PLUMBING ROOF PLAN
P-5.1	PLUMBING DETAILS
P-5.2	PLUMBING DETAILS

## **ELECTRICAL**

E-0.1	SYMBOLS LIST, GENERAL NOTES & LIST OF DRAWINGS
E-0.2	LUMINAIRE SCHEDULE
E-0.3	LUMINAIRE SCHEDULE
E-1.0	SITE PLAN - ELECTRICAL
E-1.1	SITE PLAN - LIGHTING
E-A2.1	ADMINISTRATION BLDG - LIGHTING
E-B2.1	CAFETERIA KITCHEN PLAN - LIGHTING
E-A3.1	ADMINISTRATION BLDG - POWER & SIGNAL
E-A3.2	ADMINISTRATION BLDG - MECHANICAL EQUIPMENT ELECTRICAL
E-B3.1	CAFETERIA KITCHEN PLAN - POWER & SIGNAL
E-B4.1	ENLARGED KITCHEN PLAN - POWER & SIGNAL
E-5.1	SINGLE LINE DIAGRAM - POWER
E-5.2	LIGHTING CONTROL DIAGRAMS
E-5.3	DETAILS
E-6.1	PANEL SCHEDULES
E-7.1	DETAILS
E-7.2	DETAILS
E-7.3	DETAILS
E-8.1	TITLE 24 DOCUMENTATION
E-8.2	TITLE 24 DOCUMENTATION
E-8.3	TITLE 24 DOCUMENTATION
FE-0.1	FIRE ALARM EQUIPMENT LIST AND GENERAL NOTES
FE-1.0	SITE PLAN - FIRE ALARM
FE-A3.1	ADMINISTRATION BLDG - FIRE ALARM
FE-B3.1	CAFETERIA KITCHEN PLAN - FIRE ALARM
FE-5.1	RISER DIAGRAM - FIRE ALARM
FE-6.1	CALCULATIONS - FIRE ALARM

## **FIRE PROTECTION**

FP-0.1	LEGEND, NOTES, AND DETAILS - FIRE PROTECTION
FP-1.1	SITE PLAN - FIRE PROTECTION
FP-A2.1	ADMIN BLDG PIPING PLAN - FIRE PROTECTION
FP-A3.1	ADMIN BLDG CEILING PLAN - FIRE PROTECTION
FP-A4.1	ADMIN BLDG SECTIONS - FIRE PROTECTION
FP-B2.1	CAFETERIA BLDG PIPING PLAN - FIRE PROTECTION
FP-B3.1	CAFETERIA BLDG CEILING PLAN - FIRE PROTECTION
FP-B4.1	CAFETERIA BLDG SECTIONS - FIRE PROTECTION

FP-B4.2	CAFETERIA BLDG SECTIONS - FIRE PROTECTION
FP-6.1	DETAILS - FIRE PROTECTION
FP-6.2	DETAILS AND SEISMIC BRACING CALCULATIONS - FIRE PROTECTION

#### **KITCHEN**

K1.0	FOODSERVICE EQUIPMENT FLOOR PLAN
K2.0	FOODSERVICE EQUIPMENT ELECTRICAL PLAN
K3.0	FOODSERVICE EQUIPMENT PLUMBING PLAN
K4.0	FOODSERVICE EQUIPMENT WALL BACKING
K5.0	FOODSERVICE EQUIPMENT ELEVATIONS
K5.1	FOODSERVICE EQUIPMENT ELEVATIONS
K6.0	FOODSERVICE EQUIPMENT HOOD PLAN
K6.1	FOODSERVICE EQUIPMENT HOOD PLAN
K6.2	FOODSERVICE EQUIPMENT HOOD DETAILS
K7.0	FOODSERVICE EQUIPMENT FIRE SUPPRESSION PLAN
K8.0	FOODSERVICE EQUIPMENT WALK-IN PLAN
K8.1	FOODSERVICE EQUIPMENT WALK-IN PLAN
K8.2	FOODSERVICE EQUIPMENT WALK-IN DETAILS
K8.3	FOODSERVICE EQUIPMENT WALK-IN DETAILS
K8.4	FOODSERVICE EQUIPMENT WALK-IN WIRING
K9.0	FOODSERVICE EQUIPMENT SERVERY COUNTERS

#### **CATHODIC PROTECTION**

CP.1	CP DETAILS
CP.2	CP DETAILS

#### **TITLE 24**

T-1.1	TITLE 24 BLDG A
T-1.2	TITLE 24 BLDG A
T-1.3	TITLE 24 BLDG A
T-1.4	TITLE 24 BLDG B
T-1.5	TITLE 24 BLDG B
T-1.6	TITLE 24 BLDG B
T-1.7	TITLE 24 BLDG B

**DOCUMENT 00 3100**

**INFORMATION AVAILABLE TO BIDDERS**

**PART 1 GENERAL**

**1.01 HAZARDOUS MATERIALS INVESTIGATION**

A. Hazardous Materials Investigations for Liberty Union High School District are available for review through the Liberty Union High School website at [www.luhsd.net](http://www.luhsd.net) as well as through Lathrop Construction by sending an email to [maria.galligan@lathropconstruction.com](mailto:maria.galligan@lathropconstruction.com).

B. Bidders are strongly encouraged to review this document (s) prior to bidding.

**1.02 GEOTECHNICAL INVESTIGATION**

A. Geotechnical Investigations for Liberty Union High School District are available for review through the Liberty Union High School website at [www.luhsd.net](http://www.luhsd.net) as well as through Lathrop Construction by sending an email to [maria.galligan@lathropconstruction.com](mailto:maria.galligan@lathropconstruction.com).

B. All Contractor Classifications licensed by the California State Contractors' License Board may purchase copies of the Geotechnical Investigations for the cost of printing at the facilities of Draftech Blueprinting, Inc., 1544 Terrace Way, Santa Rosa, CA 95404, (707) 578-9442. Orders shall be placed through the Architect's Office. Purchased copies are non-refundable.

C. Bidders are strongly encouraged to review this document (s) prior to bidding.

**PART 2 PRODUCTS**

2.01 Not Used.

**PART 3 EXECUTION**

3.01 Not Used.

**END OF DOCUMENT**

# **LIBERTY UNION HIGH SCHOOL DISTRICT**

## **BIDDING DOCUMENTS**

**FOR THE**

**LIBERTY UNION HIGH SCHOOL DISTRICT**

**FOR**

**ADMINISTRATION AND STUDENT COMMONS**

**AT**

**LIBERTY HIGH SCHOOL**

**850 2ND STREET, BRENTWOOD, CA 94513**

**Project No. 1783.00**

**DSA Application No. 01-119033**

**Bid No: U2019L**

**LIBERTY UNION HIGH SCHOOL DISTRICT**

**20 Oak Street, Brentwood, CA 94513**

**November 19, 2020**



THIS PAGE INTENTIONALLY LEFT BLANK FOR PRINTING PURPOSES

NOTICE INVITING BIDS ..... 1

INSTRUCTIONS TO BIDDERS ..... 5

CHECKLIST OF MANDATORY BID FORMS ..... 13

DESIGNATION OF SUBCONTRACTORS ..... 15

DESIGNATION OF SUBCONTRACTORS FORM ..... 16

BID FORM ..... 18

CONTRACTOR’S CERTIFICATE REGARDING WORKERS’ COMPENSATION FORM..... 24

NON-COLLUSION DECLARATION..... 25

BID GUARANTEE FORM..... 26

BID BOND FORM..... 27

ACKNOWLEDGMENT OF BIDDING PRACTICES REGARDING INDEMNITY FORM..... 31

DISABLED VETERAN BUSINESS ENTERPRISE (DVBE) PARTICIPATION STATEMENT ..... 32

CONTRACTOR’S CERTIFICATE REGARDING DRUG-FREE WORKPLACE..... 33

CONTRACTOR’S CERTIFICATE REGARDING ALCOHOLIC BEVERAGE AND TOBACCO-  
FREE CAMPUS POLICY ..... 34

AGREEMENT FORM..... 36

PAYMENT BOND..... 41

PERFORMANCE BOND..... 44

GUARANTEE ..... 48

ESCROW AGREEMENT FOR SECURITY DEPOSITS IN LIEU OF RETENTION..... 49

INSURANCE DOCUMENTS & ENDORSEMENTS..... 52

CONTRACTOR CERTIFICATION REGARDING BACKGROUND CHECKS .....	54
CONTRACTOR CERTIFICATION REGARDING BACKGROUND CHECKS .....	55
ARTICLE 1    DEFINITIONS.....	56
1.1    BASIC DEFINITIONS .....	56
1.2    EXECUTION, CORRELATION AND INTENT .....	61
1.3    OWNERSHIP AND USE OF ARCHITECT’S DRAWINGS, SPECIFICATIONS AND OTHER DOCUMENTS.....	65
ARTICLE 2    DISTRICT .....	67
2.1    INFORMATION AND SERVICES REQUIRED OF THE DISTRICT .....	67
2.2    DISTRICT’S RIGHT TO CARRY OUT THE WORK DUE TO PARTIAL DEFAULT IN A SPECIFIC SEGREGATED AREA OF WORK (48 HOUR NOTICE TO CURE AND CORRECT) .....	70
ARTICLE 3    THE CONTRACTOR.....	72
3.1    SUPERVISION AND CONSTRUCTION PROCEDURES .....	72
3.2    SUPERVISION .....	73
3.3    LABOR AND MATERIALS .....	74
3.4    WARRANTY .....	77
3.5    TAXES.....	78
3.6    PERMITS, FEES AND NOTICES.....	78
3.7    SUBMITTALS REQUIRED AT THE COMMENCEMENT OF THE PROJECT .....	79
3.8    DOCUMENTS, SAMPLES, AND COMPUTER AT THE SITE.....	80
3.9    SUBMITTALS INCLUDING SHOP DRAWINGS, PRODUCT DATA, AND SAMPLES .....	80
3.10    SUBSTITUTIONS.....	86
3.11    INTEGRATION OF WORK .....	88
3.12    CLEANING UP.....	89
3.13    ACCESS TO WORK.....	90
3.14    ROYALTIES AND PATENTS .....	91
3.15    INDEMNIFICATION .....	91
3.16    SUBMISSION OF DAILY REPORTS .....	91
3.17    AS-BUILT DRAWINGS AND ANNOTATED SPECIFICATIONS.....	92
3.18    EQUIPMENT MANUALS.....	93
3.19    DIR REGISTRATION .....	94
ARTICLE 4    ADMINISTRATION OF THE CONTRACT AND CLAIMS.....	95
4.1    ARCHITECT .....	95
4.2    ARCHITECT’S ADMINISTRATION OF THE CONTRACT.....	95
4.3    PROJECT INSPECTOR.....	97
4.4    STOP WORK ORDER.....	99
4.5    RESPONSIBILITY FOR ADDITIONAL CHARGES INCURRED BY THE DISTRICT FOR PROFESSIONAL SERVICES.....	99
4.6    DISPUTES AND CLAIMS .....	100

ARTICLE 5	SUBCONTRACTORS .....	109
5.1	DEFINITIONS.....	109
ARTICLE 6	CONSTRUCTION BY DISTRICT OR BY SEPARATE CONTRACTORS.....	111
6.1	DISTRICT’S RIGHT TO PERFORM CONSTRUCTION AND TO AWARD SEPARATE CONTRACTS.....	111
6.2	CONSTRUCTIVE OWNERSHIP OF PROJECT SITE AND MATERIAL .....	113
6.3	DISTRICT’S RIGHT TO CLEAN UP .....	113
ARTICLE 7	CHANGES IN THE WORK .....	114
7.1	CHANGES.....	114
7.2	CHANGE ORDERS (“CO”) .....	115
7.3	CONSTRUCTION CHANGE DOCUMENT (CCD Category A, and CCD Category B) and WORK DIRECTIVE (WD).....	115
7.4	REQUEST FOR INFORMATION (“RFI”) .....	116
7.5	REQUEST FOR PROPOSAL (“RFP”).....	117
7.6	CHANGE ORDER REQUEST (“COR”).....	118
7.7	COST OF CHANGE ORDERS.....	118
ARTICLE 8	TIME AND SCHEDULE .....	125
8.1	DEFINITIONS.....	125
8.2	HOURS OF WORK.....	127
8.3	PROGRESS AND COMPLETION .....	127
8.4	EXTENSIONS OF TIME - LIQUIDATED DAMAGES.....	131
ARTICLE 9	PAYMENTS AND COMPLETION.....	135
9.1	CONTRACT SUM .....	135
9.2	COST BREAKDOWN .....	135
9.3	PROGRESS PAYMENTS.....	136
9.4	APPLICATIONS FOR PROGRESS PAYMENTS.....	138
9.5	STOP NOTICE CLAIMS AND WARRANTY OF TITLE .....	140
9.6	DECISIONS TO WITHHOLD PAYMENT.....	141
9.7	NONCONFORMING WORK.....	142
9.8	SUBCONTRACTOR PAYMENTS .....	143
9.9	COMPLETION OF THE WORK.....	143
9.10	PARTIAL OCCUPANCY OR USE.....	148
9.11	COMPLETION AND FINAL PAYMENT .....	149
9.12	SUBSTITUTION OF SECURITIES .....	152
ARTICLE 10	PROTECTION OF PERSONS AND PROPERTY .....	153
10.1	SAFETY PRECAUTIONS AND PROGRAMS .....	153
10.2	SAFETY OF PERSONS AND PROPERTY .....	155
10.3	EMERGENCIES .....	158
10.4	HAZARDOUS MATERIALS .....	158
ARTICLE 11	INSURANCE AND BONDS .....	160
11.1	Introduction.....	160

11.2	Prequalification & Cost Identification .....	162
11.3	Owner-Provided Insurance Coverages .....	162
11.4	OCIP Certificates and Policies.....	170
11.5	Contractor/Subcontractor Responsibilities .....	170
11.6	OCIP Disclaimer.....	172
11.7	Required Contractor/Subcontractor Provided Insurance Coverages.....	172
11.8	Required Contractor/Subcontractor Certificates of Insurance and Additional Insured Endorsements.....	174
11.9	Contractor/Subcontractor Insurance for Personal Property and Equipment .....	174
11.10	Assignment of Return Premiums .....	175
11.11	Waiver of Subrogation and Owner Indemnification.....	175
11.12	No Release .....	175
11.13	Owner’s Right to Audit.....	175
11.14	Duties in the Event of a Loss .....	175
11.15	Occupational Safety and Health Compliance .....	175
11.16	Project Safety Program .....	176
11.17	Owner’s Insurance Obligations; Contractors’/Subcontractors’ Obligations; Representations, Warranties and Disclaimers.....	178
11.18	Joint Defense of Claims and Suits Against More Than One Insured .....	180
11.19	Duty of Care.....	180
11.20	BOND REQUIREMENTS .....	187
ARTICLE 12	UNCOVERING AND CORRECTION OF WORK.....	188
12.1	COMPLIANCE WITH TITLE 24 INSTALLATION REQUIREMENTS .....	188
12.2	SPECIAL NOTICE OF AMERICAN’S WITH DISABILITIES ACT .....	188
12.3	UNCOVERING OF WORK.....	189
12.4	CORRECTION OF WORK.....	189
ARTICLE 13	MISCELLANEOUS PROVISIONS.....	191
13.1	GOVERNING LAW.....	191
13.2	SUCCESSORS AND ASSIGNS .....	191
13.3	WRITTEN NOTICE.....	191
13.4	RIGHTS AND REMEDIES .....	191
13.5	TESTS AND INSPECTIONS.....	191
13.6	TRENCH EXCAVATION .....	192
13.7	WAGE RATES, TRAVEL, AND SUBSISTENCE .....	193
13.8	RECORDS OF WAGES PAID .....	195
13.9	APPRENTICES .....	196
13.10	ASSIGNMENT OF ANTITRUST CLAIMS .....	198
13.11	STATE AND DISTRICT CONDUCTED AUDITS .....	198
13.12	STORM WATER POLLUTION PREVENTION .....	199
ARTICLE 14	TERMINATION OR SUSPENSION OF THE CONTRACT.....	204
14.1	TERMINATION BY THE CONTRACTOR FOR CAUSE.....	204
14.2	TERMINATION BY THE DISTRICT FOR CAUSE.....	204
14.3	TERMINATION OF CONTRACT BY DISTRICT (CONTRACTOR NOT AT FAULT) .....	205
14.4	REMEDIES OTHER THAN TERMINATION .....	206

ARTICLE 15 DEBARMENT..... 208  
15.1 BOARD FINDING ..... 208  
15.2 HEARING AND PRESENTATION OF EVIDENCE ..... 208

## NOTICE TO CONTRACTORS

### **LIBERTY HIGH SCHOOL ADMINISTRATION AND STUDENT COMMONS PROJECT**

**NOTICE IS HEREBY GIVEN** that the Liberty Union High School District, acting by and through its Governing Board, will receive, prior to **Wednesday, December 23, 2020 at 2:00 p.m.**, sealed bids for the award of a contract for the Liberty High School Administration and Student Commons Project.

Bid documents are available on the Liberty Union High School District website at [www.luhsd.net](http://www.luhsd.net). Lathrop Construction also has bid documents available on Procore. To request access, please contact Maria Galligan at [maria.galligan@lathropconstruction.com](mailto:maria.galligan@lathropconstruction.com).

All interested bidders must attend a mandatory Pre-Bid Conference at the front entry to Liberty High School, 850 2<sup>nd</sup> Street; Brentwood, CA 94513 at 10:00 a.m. on Friday, December 4, 2020. All attendees are required to wear masks and comply with CDC and Contra Costa County Health Order requirements.

**PREQUALIFICATION OF PRIME CONTRACTORS AND MEP SUBCONTRACTORS IS REQUIRED FOR THIS PROJECT. ALL BIDDERS MUST HAVE RECEIVED PRIOR PREQUALIFICATION APPROVAL FROM THE DISTRICT IN ORDER TO SUBMIT A BID FOR THIS PROJECT.**

The engineer's approximate estimate for this project is \$16,000,000.00.

#### **Scope of Work:**

Project provides a new 9,705 square foot Administration and Student Services Building, a modernization of the existing 3,709 square foot A Wing Building, partial demolition and modernization of the existing Cafeteria Building (7,790 square feet) and new addition to the Cafeteria Building (1,540 square feet of Student Commons and associated site development). The new Administration and Student Services Building includes offices, break rooms, toilet rooms and related spaces. The building is construction Type 5B, wood framed, fully sprinklered for B occupancy. The modernization of the A Wing Building includes selective demolition, installation of new finishes and fire sprinklers, transoms windows. Existing building is wood framed A-3 occupancy. The modernization and new construction of the Cafeteria Building includes partial building demolition, selective demolition of the remaining portion of the building, installation of new finishes, fire sprinklers, windows and openings, kitchen equipment, electrical, mechanical and plumbing items. Existing building is concrete wood framed for an A-2 occupancy. The site development includes selective demolition and provision of parking lot with passenger drop-off/loading, concrete paved walkways, plaza and amphitheater, construction yard, landscaping, bio-swales, site lighting, and fencing.

### **Additive/ Deductive Bid Alternates (See Section 13 of Instruction to Bidders)**

If the District has included additive/ deductive alternates which require all bidders to price as part of their bid, the District will utilize the following method to determine the lowest bidder in accordance with Public Contract Code section 20103.8:

- ✓ The lowest bid shall be the lowest bid price on the base contract without consideration of the prices on the additive or deductive items.
- The lowest bid shall be the lowest total of the bid prices on the base contract and the following additive or deductive items:

Alternative No. 01 – Resilient flooring:

1. Base Bid Item: Section 09 6500 and Drawing number A-B2.2 including rubber flooring.
2. Alternate Bid Item Section 09 6500 and Drawing number A-B2.2 including Linoleum pored flooring

**\*\*Note:** Pursuant to Public Contract Code section 20103.8, the selection process selected does not preclude the District from using any of the additive or deductive alternates from the Contract after the lowest responsible responsive bidder has been determined.

### **Miscellaneous Information**

Bids shall be received in the place identified above and shall be opened and publicly read aloud at the above-stated time and place.

The bid documents are available on the Liberty Union High School District website at [www.luhdsd.net](http://www.luhdsd.net) as well as through Lathrop Construction by sending an email to [maria.galligan@lathropconstruction.com](mailto:maria.galligan@lathropconstruction.com).

**There will be a mandatory Pre-Bid Conference on Friday December 4th at 10am at the front entry to Liberty High School at 850 2nd Street Brentwood, CA 94513.** All attendees are required to wear masks and comply with CDC and Contra Costa Any Contractor bidding on the Project who fails to attend the entire mandatory job walk and conference will be deemed a non-responsive bidder and will have its bid returned unopened.

Each bidder shall be a licensed contractor pursuant to the California Business and Professions Code, and be licensed to perform the work called for in the Contract Documents. The successful bidder must possess a valid and active Class B License at the time of bid and throughout the duration of this Contract. The Contractor's California State License number shall be clearly stated on the bidder's proposal

Subcontractors shall be licensed pursuant to California law for the trades necessary to perform the Work called for in the Contract Documents.

Each bid must strictly conform with and be responsive to the Contract Documents as defined in the General Conditions.



The District reserves the right to reject any or all bids or to waive any irregularities or informalities in any bids or in the bidding.

Each bidder shall submit with its bid — on the form furnished with the Contract Documents — a list of the designated subcontractors on this Project as required by the Subletting and Subcontracting Fair Practices Act, California Public Contract Code section 4100 et seq.

In accordance with California Public Contract Code section 22300, the District will permit the substitution of securities for any moneys withheld by the District to ensure performance under the Contract. At the request and expense of the Contractor, securities equivalent to the amount withheld shall be deposited with the District, or with a state or federally chartered bank as the escrow agent, who shall then pay such moneys to the Contractor. Upon satisfactory completion of the Contract, the securities shall be returned to the Contractor.

Each bidder's bid must be accompanied by one of the following forms of bidder's security: (1) cash; (2) a cashier's check made payable to the District; (3) a certified check made payable to the District; or (4) a bidder's bond executed by a California admitted surety as defined in Code of Civil Procedure section 995.120, made payable to the District in the form set forth in the Contract Documents. Such bidder's security must be in an amount not less than ten percent (10%) of the maximum amount of bid as a guarantee that the bidder will enter into the proposed Contract, if the same is awarded to such bidder, and will provide the required Performance and Payment Bonds, insurance certificates and any other required documents. In the event of failure to enter into said Contract or provide the necessary documents, said security will be forfeited.

The Contractor and all subcontractors shall comply with the requirements set forth in Division 2, Part 7, Chapter 1 of the Labor Code. The District has obtained from the Director of the Department of Industrial Relations the general prevailing rate of per diem wages and the general prevailing rate for holiday and overtime work in the locality in which this work is to be performed for each craft, classification or type of worker needed to execute the Contract. These per diem rates, including holiday and overtime work, as well as employer payments for health and welfare, pension, vacation, and similar purposes, are on file at the District, and are also available from the Director of the Department of Industrial Relations. Pursuant to California Labor Code section 1720 et seq., it shall be mandatory upon the Contractor to whom the Contract is awarded, and upon any subcontractor under such Contractor, to pay not less than the said specified rates to all workers employed by them in the execution of the Contract.

A contractor or subcontractor shall not be qualified to bid on, be listed in a bid proposal, subject to the requirements of Section 4104 of the Public Contract Code, or engage in the performance of any contract for public work, as defined in the Labor Code, unless currently registered and qualified to perform public work pursuant to Labor Code section 1725.5. It is not a violation of this section for an unregistered contractor to submit a bid that is authorized by Section 7029.1 of the Business and Professions Code or by Section 10164 or 20103.5 of the Public Contract Code, provided the contractor is registered to perform public work pursuant to Section 1725.5 at the time the contract is awarded.

The Contractor and all subcontractors shall furnish certified payroll records as required pursuant Labor Code section 1776 directly to the Labor Commissioner in accordance with Labor Code section 1771.4 on at least on a monthly basis (or more frequently if required by the District or the Labor Commissioner) and in a format prescribed by the Labor Commissioner. Monitoring and enforcement of the prevailing wage laws and related requirements will be performed by the Labor Commissioner/ Department of Labor Standards Enforcement (DLSE).

No bidder may withdraw any bid for a period of ninety (90) calendar days after the date set for the opening of bids.

Separate payment and performance bonds, each in an amount equal to 100% of the total Contract amount, are required, and shall be provided to the District prior to execution of the Contract and shall be in the form set forth in the Contract Documents.

All bonds (Bid, Performance, and Payment) must be issued by a California admitted surety as defined in California Code of Civil Procedure section 995.120.

Where applicable, bidders must meet the requirements set forth in Public Contract Code section 10115 et seq., Military and Veterans Code section 999 et seq. and California Code of Regulations, Title 2, Section 1896.60 et seq. regarding Disabled Veteran Business Enterprise (“DVBE”) Programs. Forms are included in this Bid Package.

Any request for substitutions pursuant to Public Contract Code section 3400 must be made at the time of Bid on the Substitution Request Form set forth in the Contract Documents and included with the bid.

No telephone or facsimile machine will be available to bidders on the District premises at any time.

It is each bidder’s sole responsibility to ensure its bid is timely delivered and received at the location designated as specified above. Any bid received at the designated location after the scheduled closing time for receipt of bids shall be returned to the bidder unopened.

---

LIBERTY UNION HIGH SCHOOL DISTRICT

## **INSTRUCTIONS TO BIDDERS**

1. **Preparation of Bid Form.** Proposals under these specifications shall be submitted on the blank forms furnished herewith at the time and place stated in the Notice Inviting Bids. All blanks in the bid form must be appropriately filled in, and all proposed prices must be stated clearly and legibly in both words and numerals. All bids must be signed by the bidder in permanent blue ink and submitted in sealed envelopes, bearing on the outside, the bidder's name, address, telephone number, and California Contractor's License number, and the name of the Project for which the bid is submitted. The District reserves the right to reject any bid if all of the above information is not furnished. It is each bidder's sole responsibility to ensure its bid is timely delivered and received at the location designated as specified above. Any bid received at the designated location after the scheduled closing time for receipt of bids shall be returned to the bidder unopened.

2. **Bid Security.** Each bid must be accompanied by one of the following forms of bidder's security: (1) cash; (2) a cashier's check made payable to the District; (3) a certified check made payable to the District; or (4) a bidder's bond executed by a California admitted surety as defined in Code of Civil Procedure section 995.120, made payable to the District, in the form set forth in the Contract Documents. Such bidder's security must be in an amount not less than ten percent (10%) of the maximum amount of such bidder's bid as a guarantee that the bidder will enter into the Contract, if the same is awarded to such bidder, and will provide the required Performance and Payment Bonds, insurance certificates and any other required documents. In the event that a bidder is awarded the Contract and such bidder fails to enter into said Contract or provide the surety bond or bonds within five (5) calendar days after award of the Contract to bidder, said security will be forfeited.

3. **Signature.** The bid form, all bonds, all designations of subcontractors, the Contractor's Certificate, the Agreement, and all Guarantees must be signed in permanent blue ink in the name of the bidder and must bear the signature in longhand of the person or persons duly authorized to sign the bid.

If bidder is a corporation, the legal name of the corporation shall first be set forth, together with two signatures: one from the President and one from the Secretary or Assistant Secretary. Alternatively, the signature of other authorized officers or agents may be affixed, if a certified copy of the resolution of the corporate board of directors authorizing them to do so is provided to the District. Such documents shall include the title of such signatories below the signature and shall bear the corporate seal.

If bidder is a partnership, the true name of the firm shall first be set forth, together with the names of all persons comprising the partnership or co-partnership. The bid must be signed by all partners comprising the partnership unless proof in the form of a certified copy of a statement of partnership acknowledging the signer to be a general partner is presented to the District, in which case the general partner may sign.

Bids submitted as joint ventures must so state and be signed by each joint venturer.

Bids submitted by individuals must be signed by the bidder unless an up to date power- of-attorney is on file in the District office, in which case, said person may sign for the individual.

The above rules also apply in the case of the use of a fictitious firm name. In addition, however, where a fictitious name is used, it must be so indicated in the signature.

4. Modifications. Changes in or additions to the bid form, recapitulations of the work bid upon, alternative proposals, or any other modification of the bid form which is not specifically called for in the Contract Documents may result in the District's rejection of the bid as not being responsive to the Notice Inviting Bids. **No oral or telephonic modification of any bid submitted will be considered.**

5. Erasures, Inconsistent or Illegible Bids. The bid submitted must not contain any erasures, interlineations, or other corrections unless each such correction creates no inconsistency and is suitably authenticated by affixing in the margin immediately opposite the correction the signature or signatures of the person or persons signing the bid. In the event of inconsistency between words and figures in the bid price, words shall control figures. In the event that the District determines that any bid is unintelligible, inconsistent, or ambiguous, the District may reject such bid as not being responsive to the Notice Inviting Bids.

6. Examination of Site and Contract Documents. Each bidder shall visit the site of the proposed work and become fully acquainted with the conditions relating to the construction and labor so that the facilities, difficulties, and restrictions attending the execution of the work under the Contract are fully understood. Bidders shall thoroughly examine and be familiar with the drawings and specifications and all other documents and requirements that are attached to and/or contained in the Project Manual or other documents issued to bidders. The failure or omission of any bidder to receive or examine any Contract Documents, form, instrument, addendum, or other document or to visit the site and become acquainted with conditions there existing shall not relieve any bidder from obligations with respect to the bid or to the contract. The submission of a bid shall be taken as prima facie evidence of compliance with this Section. Bidders shall not, at any time after submission of the bid, dispute, complain, or assert that there were any misunderstandings with regard to the nature or amount of work to be done.

7. Withdrawal of Bids. Any bid may be withdrawn, either personally or by written request, at any time prior to the scheduled closing time for receipt of bids. The bid security for bids withdrawn prior to the scheduled closing time for receipt of bids, in accordance with this paragraph, shall be returned upon demand therefor.

No bidder may withdraw any bid for a period of ninety (90) calendar days after the date set for the opening of bids.

8. Agreements, Insurance and Bonds. The Agreement form which the successful bidder, as Contractor, will be required to execute, and the forms and amounts of surety bonds and insurance endorsements which Contractor will be required to be furnished at the time of execution of the Agreement, are included in the bid documents and should be carefully examined by the bidder. The number of executed copies of the Agreement, the Performance Bond, and the Payment Bond required is three (3). Payment and Performance bonds must be executed by an admitted surety insurer as defined in Code of Civil Procedure 995.120.

9. Interpretation of Plans and Documents/Pre-Bid Clarification. If any prospective bidder is in doubt as to the true meaning of any part of the Contract Documents, or finds discrepancies in, or omissions, a written request for an interpretation or correction thereof may be submitted to the District. The bidder submitting the request shall be responsible for its prompt delivery. **Any interpretation or correction of the Contract Documents will only be made by Addendum duly issued, and a copy of such Addendum will be made available for each contractor receiving a set of the Contract Documents.** No person is authorized to make any oral interpretation of any provision in the Contract Documents, nor shall any oral interpretation be binding on the District. If discrepancies on drawings, specifications or elsewhere in the Contract Documents are not covered by addenda, bidder shall include in their bid methods of construction

and materials for the higher quality and complete assembly. Each request for clarification shall be submitted in writing, via email, to only the following persons:

TO: Cam Hawing (QKA Architects)  
camh@qka.com

Each transmitted request shall contain the name of the person and/or firm filing the request, address, telephone, and fax number, Specifications and/or Drawing number. Bidder is responsible for the legibility of hand written requests. Pre-bid clarification request shall be filed a minimum of **ten (10)** days prior to bid opening. Requests received less than **ten (10)** days before bid opening shall not be considered or responded to. A written response to timely pre-bid clarifications requests which materially affects the bidders price will be made by Bid Clarification or Addendum issued by the District not less than seventy-two (72) hours prior to bid opening.

10. Bidders Interested in More Than One Bid. No person, firm, or corporation shall be allowed to make, or file, or be interested in more than one prime bid for the same work unless alternate bids are specifically called for. A person, firm, or corporation that has submitted a proposal to a bidder, or that has quoted prices of materials to a bidder, is not thereby disqualified from submitting a proposal or quoting prices to other bidders or making a prime proposal.

11. Award of Contract. The Contract will be awarded to the lowest responsive responsible bidder by action of the governing Board. The District reserves the right to reject any or all bids, or to waive any irregularities or informalities in any bids or in the bidding. In the event an award is made to bidder, and such bidder fails or refuses to execute the Contract and provide the required documents within five (5) calendar days after award of the Contract to bidder, the District may award the Contract to the next lowest responsible and responsive bidder or release all bidders. **Each bid must conform and be responsive to the Contract Documents as defined in the General Conditions.**

12. Bid Protest Procedure. Any bidder may file a bid protest. The protest shall be filed in writing with the District's Facilities Director not more than five (5) business days after the date of the bid opening. An e-mail address shall be provided and by filing the protest, protesting bidder consents to receipt of e-mail notices for purposes of the protest and protest related questions and protest appeal, if applicable. The protest shall specify the reasons and facts upon which the protest is based.

a. Resolution of Bid Controversy: Once the bid protest is received, the apparent lowest responsible bidder will be notified of the protest and the evidence presented. If appropriate, the apparent low bidder will be given an opportunity to rebut the evidence and present evidence that the apparent low bidder should be allowed to perform the Work. If deemed appropriate by the District, an informal hearing will be held. District will issue a written decision within fifteen (15) calendar days of receipt of the protest, unless factors beyond the District's reasonable control prevent such resolution. The decision on the bid protest will be copied to all parties involved in the protest.

b. Appeal: If the protesting bidder or the apparent low bidder is not satisfied with the decision, the matter may be appealed to the Chief Business Officer or their designee, within three (3) business days after receipt of the District's written decision on the bid protest. The appeal must be in writing and sent via overnight registered mail with all accompanying information relied upon for the appeal and an e-mail address from which questions and responses may be provided to:

**Liberty Union High School District  
Business Department  
20 Oak Street, Brentwood, CA 94513**

c. Appeal Review: The Chief Business Officer or their designee shall review the decision on the bid protest from the Director of Facilities and issue a written response to the appeal, or if appropriate, appoint a Hearing Office to conduct a hearing and issue a written decision. The written decision of the Chief Business Officer or the Hearing Officer shall be rendered within fifteen (15) calendar days and shall state the basis for the decision. The decision concerning the appeal will be final and not subject to any further appeals.

d. Reservation of Rights to Proceed with Project Pending Appeal. The District reserves the right to proceed to award the Project and commence construction pending an Appeal. If there is State Funding or a critical completion deadline, the District may choose to shorten the time limits set forth in this Section if written notice is provided to the protesting party. E-mailed notice with a written confirmation sent by First Class Mail shall be sufficient to constitute written notice. If there is no written response to a written notice shortening time, the District may proceed with the award.

e. Finality. Failure to comply with this Bid Protest Procedure shall constitute a waiver of the right to protest and shall constitute a failure to exhaust the protesting bidder's administrative remedies.

13. Alternates. If alternate bids are called for, the Contract may be awarded at the election of the Governing Board to the lowest responsible and responsive bidder using the method and procedures outlined in the Notice Inviting Bids and as specified in the section entitled Alternate/Deductive Bid Alternates.

a. Subcontractor Listing for Alternates. If alternate bids are called for and the bidder intends to use different or additional subcontractors, a separate list of subcontractors must be submitted for each such alternate.

14. Evidence of Responsibility. Upon the request of the District, a bidder whose bid is under consideration for the award of the Contract shall submit promptly to the District satisfactory evidence showing the bidder's financial resources, surety and insurance claims experience, construction experience, completion ability, workload, organization available for the performance of the Contract, and other factors pertinent to a Project of the scope and complexity involved.

15. Listing Subcontractors. Each bidder shall submit with his bid, on the form furnished with the Contract Documents, a list of the names, license numbers, scopes of work, locations of the places of business, contact information, and Department of Industrial Relations ("DIR") registration numbers of each subcontractor who will perform work or labor or render service to the bidder in or about the project, or a subcontractor who under subcontract to the bidder, specially fabricates and installs a portion of the work, in an amount in excess of one-half of 1 percent of the bidder's total bid as required by the Subletting and Subcontracting Fair Practices Act (Public Contract Code section 4100, et seq.) Pursuant to Labor Code section 1725.5, all subcontractors (of any tier) performing work on this Project must be properly registered with DIR.

16. Workers' Compensation. In accordance with the provisions of Labor Code section 3700, the successful bidder as the Contractor shall secure payment of compensation to all employees. The Contractor shall sign and file with the District the following certificate prior to performing the work under this contract: "I am aware of the provisions of Section 3700 of the Labor Code, which requires every employer to be insured against liability for workers' compensation or to undertake self-insurance in accordance with the

provisions of that code, and I will comply with such provisions before commencing the performance of the work of this contract.” The form of such certificate is included as a part of the Bid Documents.

17. Contractor’s License. To perform the work required by this notice, the Contractor must possess the Contractor’s License as specified in the Notice Inviting Bids, and the Contractor must maintain the license throughout the duration of the contract. If, at the time of bid, bidder is not licensed to perform the Project in accordance with Division 3, Chapter 9, of the Business and Professions Code for the State of California and the Notice to Contractors calling for bids, such bid will not be considered and the Contractor will forfeit its bid security to the District.

18. Anti-Discrimination. It is the policy of the District that in connection with all work performed under contracts, there be no discrimination against any prospective or active employee engaged in the work because of race, color, ancestry, national origin, religious creed, sex, age, or marital status. The Contractor agrees to comply with applicable federal and California laws, including, but not limited to, the California Fair Employment and Housing Act, beginning with Government Code section 12900 and Labor Code section 1735. In addition, the Contractor agrees to require like compliance by any subcontractors employed on the work by such Contractor.

19. Preference for Materials and Substitutions.

a. One Product Specified. Unless the Plans and Specifications state that no Substitution is permitted, whenever the Contract Documents indicate any specific article, device, equipment, product, material, fixture, patented process, form, method, construction, or any specific name, make, trade name, or catalog number, with or without the words, “or equal,” such specification shall be read as if the language “or equal” is incorporated.

b. Request for Substitution. Bidder may, unless otherwise stated, offer any material, process, article, etc., which is materially equal or better in every respect to that so indicated or specified (“Specified Item”) and will completely accomplish the purpose of the Contract Document. If bidder desires to offer a Substitution for a Specified Item, such bidder must make a request in writing on the District’s Substitution Request Form and submit the completed Request Form for review within the time frame established by Project Requirements Specification Section 01 6000, article 3.01. The Request Form must be accompanied by evidence in full conformance with Specification Section 01 6000 including whether the proposed substitution:

- 1) Is equal in quality, service, and ability to the Specified Item as demonstrated by a side by side comparison of key characteristics and performance criteria (CSI comparison chart);
- 2) Will entail no changes in detail, construction and scheduling of related work;
- 3) Will be acceptable in consideration of the required design and artistic effect;
- 4) Will provide no cost disadvantage to the District;
- 5) Will require no excessive or more expensive maintenance, including adequacy and availability of replacement parts; and
- 6) Will require no change in the Contract Time.

After the District’s receipt of such evidence by bidder, the District will make its final decision as to whether the bidder’s request for Substitution for any Specified Items will be granted. The District shall have sole discretion in deciding as to whether a proposed request for Substitution is equal to or better than a Specified Item. Any request for Substitution which is granted by the District shall be documented and processed through a Bid Clarification or Addendum. The District may condition its approval of any Substitution upon delivery to the District of an extended warranty or other assurances of

adequate performance of the Substitution. Any and all risks of delay due to DSA, or any other governmental agency having jurisdiction shall be on the bidder.

20. Disqualification of Bidders and Proposals. More than one proposal for the same work from any individual, firm, partnership, corporation, or association under the same or different names will not be accepted; and reasonable grounds for believing that any bidder is interested in more than one proposal for the work will be cause for rejecting all proposals in which such bidder is interested and the bidder will forfeit their bid security to the District.

21. Unbalanced or Altered Bids. Proposals in which the prices are obviously unbalanced, and those which are incomplete or show any alteration of form, or contain any additions or conditional or alternate bids that are not called for or otherwise permitted, may be rejected. A proposal on which the signature of the bidder has been omitted may be rejected. If, in the District's sole discretion, it determines any pricing, costs or other information submitted by a bidder may result in an unbalanced bid, the District may deem such bid non-responsive. A bid may be determined by the District to be unbalanced if the bid is based on prices significantly less than cost for some work and prices which are significantly overstated in relation to cost for other work, and if there is a reasonable doubt that the bid will result in the lowest overall cost to the District even though it may be the low evaluated bid, or if it is so unbalanced as to be tantamount to allowing an advanced payment.

22. Employment of Apprentices. The Contractor and all Subcontractors shall comply with the provisions of California Labor Code including, but not limited to sections 1777.5, 1777.6, and 1777.7 concerning the employment of apprentices. The Contractor and any Subcontractor under him shall comply with the requirements of said sections, including applicable portions of all subsequent amendments in the employment of apprentices; however, the Contractor shall have full responsibility for compliance with said Labor Code sections, for all apprenticeable occupations, regardless of any other contractual or employment relationships alleged to exist.

23. Non-Collusion Declaration. Public Contract Code section 7106 requires bidders to submit declaration of non-collusion with their bids. This form is included with the bid documents and must be signed and dated by the bidder under penalty of perjury.

24. Wage Rates, Travel and Subsistence.

a. The Contractor and all subcontractors shall comply with the requirements set forth in Division 2, Part 7, Chapter 1 of the Labor Code. Pursuant to Labor Code section 1770 et seq., the District has obtained from the Director of the Department of Industrial Relations the general prevailing rate of per diem wages and the general prevailing rate for holiday and overtime work in the locality in which this work is to be performed for each craft, classification or type of worker needed to execute the contract. Copies are available from the District to any interested party on request and are also available from the Director of the Department of Industrial Relations. The Contractor shall obtain copies of the above-referenced prevailing wage sheets and post a copy of such wage rates at appropriate, conspicuous, weatherproof points at the Site.

b. Any worker employed to perform work on the Project and such work is not covered by any classification listed in the published general prevailing wage rate determinations or per diem wages determined by the Director of the Department of Industrial Relations, shall be paid not less than the minimum rate of wages specified therein for the classification which most nearly corresponds to the employment of such person in such classification.

c. Holiday and overtime work, when permitted by law, shall be paid for at the rate set forth in the prevailing wage rate determinations issued by the Director of the Department of Industrial Relations



or at least one and one-half (1½) times the specified basic rate of per diem wages, plus employer payments, unless otherwise specified in the Contract Documents or authorized by law.

d. These per diem rates, including holiday and overtime work, and employer payments for health and welfare, pension, vacation, and similar purposes, are on file at the administrative office of the District, located as noted above and are also available from the Director of the Department of Industrial Relations. It is the Contractor's responsibility to ensure the appropriate prevailing rates of per diem wages are paid for each classification. It shall be mandatory upon the Contractor to whom the Contract is awarded, and upon any subcontractor under such Contractor, to pay not less than the said specified rates to all workers employed by them in the execution of the Contract.

25. DIR Registration of Contractor and Subcontractors. A contractor or subcontractor shall not be qualified to bid on, be listed in a bid proposal, subject to the requirements of Section 4104 of the Public Contract Code, or engage in the performance of any contract for public work, as defined in the Labor Code, unless currently registered and qualified to perform public work pursuant to Section 1725.5. It is not a violation of this section for an unregistered contractor to submit a bid that is authorized by Section 7029.1 of the Business and Professions Code or by Section 10164 or 20103.5 of the Public Contract Code, provided the contractor is registered to perform public work pursuant to Section 1725.5 at the time the contract is awarded.

This Project is a public works project as defined in Labor Code section 1720. Each contractor bidding on this Project and all subcontractors (of any tier) performing any portion of the Work must comply with the Labor Code sections 1725.5 and 1771.1 and must be properly and currently registered with DIR and qualified to perform public works pursuant to Labor Code section 1725.5 throughout the duration of the Project. For more information and up to date requirements, contractors are recommended to periodically review the DIR's website at [www.dir.ca.gov](http://www.dir.ca.gov). Contractor shall be solely responsible for ensuring compliance with Labor Code section 1725.5 as well as any requirements implemented by DIR applicable to its services or its subcontractors throughout the term of the Agreement and in no event shall contractor be granted increased payment from the District or any time extensions to complete the Project as a result of contractor's efforts to maintain compliance with the Labor Code or any requirements implemented by the DIR. Failure to comply with these requirements shall be deemed a material breach of this Agreement and grounds for termination for cause. The contractor and all subcontractors shall furnish certified payroll records as required pursuant Labor Code section 1776 directly to the Labor Commissioner in accordance with Labor Code section 1771.4 on at least on a monthly basis (or more frequently if required by the District or the Labor Commissioner) and in a format prescribed by the Labor Commissioner. The District reserves the right to withhold contract payments if the District is notified, or determines as the result of its own investigation, that contractor is in violation of any of the requirements set forth in Labor Code section 1720 et seq. at no penalty or cost to the District. Monitoring and enforcement of the prevailing wage laws and related requirements will be performed by the Labor Commissioner/ Department of Labor Standards Enforcement (DLSE).

26. No Telephone or Facsimile Availability. No telephone or facsimile machine will be available to bidders on the District premises at any time.

27. Obtaining Bidding Documents. Bidding Documents, may be obtained from:

Liberty Union High School District Website – [www.luhdsd.net](http://www.luhdsd.net)

Lathrop Construction – email Maria Galligan at [maria.galligan@lathropconstruction.com](mailto:maria.galligan@lathropconstruction.com)

Bidder shall utilize a complete set of Bidding Documents in preparing a bid. The failure or omission of bidder to receive any Bidding Document, form, instrument, Addendum, or other document shall not relieve bidder from any obligations with respect to the bid and/or Contract.

28. Addenda. Clarification or any other notice of a change in the Bidding Documents will be issued only by the District and only in the form of a written Addendum, transmitted by fax, e-mail, or available for pick up to all who are known by the issuing office to have received a complete set of Bidding Documents. Any other purported Addenda are void and unenforceable.

Bidder is responsible for ascertaining the disposition of all Addenda issued regardless of District notification and to acknowledge all Addenda in the submitted sealed bid prior to the bid opening. Copies of Addenda will be made available for inspection wherever Bidding Documents are on file for inspection. Each Addendum will be numbered, dated, and identified with the Project number. Oral statements or any instructions in any form, other than Addendum as described above, shall be void and unenforceable. Addenda issued by the District and not noted as being acknowledged by bidder as required in the Bid Form, may result in the bid being deemed non-responsive.

29. Debarment. Bidder may also be subject to debarment, in addition to seeking remedies for False Claims under Government Code section 12650 et seq. and Penal Code section 72, the District may debar a Contractor pursuant to Article 15 of the General Conditions if the Board, or the Board may designate a hearing officer who, in his or her discretion, finds the Contractor has done any of the following:

- a. Intentionally or with reckless disregard, violated any term of a contract with the District
- b. Committed an act or omission which reflects on the Contractor's quality, fitness or capacity to perform work for the District;
- c. Committed an act or offense which indicates a lack of business integrity or business honesty; or,
- d. Made or submitted a false claim against the District or any other public entity (See Government Code section 12650, et seq., and Penal Code section 72)

## **CHECKLIST OF MANDATORY BID FORMS**

(For Contractor's use and reference only. Additional documents may be required so bidders should carefully review all Contract Documents and Bid Documents)

Designation of Subcontractors

Bid Form

Contractor's Certificate Regarding Workers Compensation

Non-Collusion Declaration

Bid Bond (or Bid Guarantee form if Security is other than Bid Bond)

Acknowledgment of Bidding Practices Regarding Indemnity

DVBE Participation Statement

Contractor's Certificate Regarding Drug-Free Work Place

Contractor's Certificate Regarding Alcoholic Beverage and Tobacco-Free Campus Policy

PRE-BID CLARIFICATION FORM (For Contractor's Use)

PROJECT NAME:	Administration and Student Commons		
PROJECT NUMBER:	1783.00		
TO:	Cam Hawing	EMAIL:	camh@qka.com

DATE:			
FROM:		EMAIL:	
DOCUMENT/DIVISION NUMBER:		DRAWING NUMBER:	

REQUESTED CLARIFICATION:

RESPONSE TO CLARIFICATION: <b>Only by Bid Clarification or Addendum</b>

Attach additional numbered sheets as necessary; however, only one (1) request shall be contained on each submitted form.

## DESIGNATION OF SUBCONTRACTORS

In compliance with the Subletting and Subcontracting Fair Practices Act (California Public Contract Code section 4100 et seq.,) and any amendments thereof, each Bidder shall set forth below: (a) the name, license number, and location of the place of business of each subcontractor who will perform work or labor or render service to the Contractor, who will perform work or labor or work or improvement to be performed under this Contract, or a subcontractor licensed by the State of California who, under subcontract to the Contractor, specially fabricates and installs a portion of the work or improvements according to detailed Drawings contained in the Plans and Specifications in an amount in excess of one-half of one percent of the Contractor's total bid; and (b) the portion and description of the work which will be done by each subcontractor under this Act. The Contractor shall list only one subcontractor for each such portion as is defined by the Contractor in this bid. All subcontractors shall be properly licensed by the California State Licensing Board.

If a Contractor fails to specify a subcontractor, or if a Contractor specifies more than one subcontractor for the same portion of work to be performed under the Contract in excess of one-half of one percent of the Contractor's total bid, the Contractor shall be deemed to have agreed that the Contractor is fully qualified to perform that portion, and that the Contractor alone shall perform that portion.

No Contractor whose bid is accepted shall (a) substitute any subcontractor, (b) permit any subcontractor to be voluntarily assigned or transferred or allow the relevant portion of the work to be performed by anyone other than the original subcontractor listed in the original bid, or (c) sublet or subcontract any portion of the work in excess of one-half of one percent of the Contractor's total bid where the original bid did not designate a subcontractor, except as authorized in the Subletting and Subcontracting Fair Practices Act.

Subletting or subcontracting of any portion of the work in excess of one-half of one percent of the Contractor's total bid where no subcontractor was designated in the original bid shall only be permitted in cases of public emergency or necessity, and then only after a finding, reduced to writing as a public record, of the authority awarding this Contract setting forth the facts constituting the emergency or necessity.

All subcontractors (of any tier) performing any portion of the Work must comply with the Labor Code sections 1725.5 and 1771.1 and must be properly and currently registered with the California Department of Industrial Relations and qualified to perform public works pursuant to Labor Code section 1725.5 throughout the duration of the Project.

**NOTE:** If alternate bids are called for and bidder intends to use different or additional subcontractors on the alternates, a separate list of subcontractors must be provided for each such Alternate.

**DESIGNATION OF SUBCONTRACTORS FORM**

<b>Scope of Work</b>	<b>Name of Subcontractor</b>	<b>Location &amp; Place of Business</b>	<b>License Type and Number</b>	<b>DIR Registration Number</b>	<b><i>E-Mail &amp; Telephone*</i></b>

Scope of Work	Name of Subcontractor	Location & Place of Business	License Type and Number	DIR Registration Number	E-Mail & Telephone*

\* This information must be provided at the time of submission of bid or must be provided within 24 hours after the time set for the opening of bids. Bidders who choose to provide this information within 24 hours after the time set for the opening of bids are solely responsible to ensure the District receives this information in a timely manner. The District is not responsible for any problems or delays associated with emails, faxes, delivery, etc. Absent a verified fax or email receipt date and time by the District, the District's determination of whether the information was received timely shall govern and be determinative. Bidder shall not revise or amend any other information in this form submitted at the time of bid. The information submitted at the time of bid shall govern over any conflicts, discrepancies, ambiguities or other differences in any subsequent Subcontractor Designation Forms submitted by the bidder.

Proper Name of Bidder: \_\_\_\_\_  
Date: \_\_\_\_\_  
Name: \_\_\_\_\_  
Signature of Bidder  
Representative: \_\_\_\_\_  
Address: \_\_\_\_\_  
Phone: \_\_\_\_\_  
\_\_\_\_\_

**BID FORM**

**FOR**

**Administration and Student Administration**

**850 2<sup>nd</sup> Street, Brentwood CA 94513**

**Project No. 1783.00**

**Bid No. U2019L**

**FOR**

**LIBERTY UNION HIGH SCHOOL DISTRICT**

CONTRACTOR  
NAME:

\_\_\_\_\_

ADDRESS:

\_\_\_\_\_

\_\_\_\_\_

TELEPHONE:

(       )

\_\_\_\_\_

FAX:

(       )

\_\_\_\_\_

EMAIL

\_\_\_\_\_



TO: Liberty Union High School District, acting by and through its Governing Board, herein called "District".

1. Pursuant to and in compliance with your Notice Inviting Bids and other documents relating thereto, the undersigned bidder, having familiarized himself with the terms of the Contract, the local conditions affecting the performance of the Contract, the cost of the work at the place where the work is to be done, with the Drawings and Specifications, and other Contract Documents, hereby proposes and agrees to perform within the time stipulated, the Contract, including all of its component parts, and everything required to be performed, including its acceptance by the District, and to provide and furnish any and all labor, materials, tools, expendable equipment, and utility and transportation services necessary to perform the Contract and complete all of the Work in a workmanlike manner required in connection with the construction of:

**LIBERTY HIGH SCHOOL ADMINISTRATION AND STUDENT COMMONS (as described below):**

Project provides a new 9,705 square foot Administration, a modernization of the existing 3,709 square foot A Wing, partial demolition of existing Building B, modernization of Building (7,790 square feet) and new addition to Building B (1,540 square feet of Student Commons and associated site development.

The Administration building includes offices, break rooms, toilet rooms and related spaces. The building is construction Type 5B, wood framed, fully sprinklered for B occupancy.

The modernization of Wing A includes selective demolition, installation of new finishes and fire sprinklers, transaction windows. Existing building is Wood framed A-3 occupancy.

The modernization and new construction of Wing B include partial building demolition, selective demolition of the remaining portion of the building, installation of new finishes, fire sprinklers, windows and opening, kitchen equipment, electrical, mechanical and plumbing items. Existing building is concrete wood framed for an A-2 occupancy.

The site development includes selective demolition and provision of parking lot with passenger drop-off/loading, concrete paved walkways, plaza and amphitheater, construction yard, landscaping, bio-swales, site lighting, and fencing.

**For the:**

**LIBERTY HIGH SCHOOL ADMINISTRATION AND STUDENT COMMONS**

BID NO. U2019L

Liberty High School Administration and Student Commons.

in the District described above, all in strict conformance with the drawings and other Contract Documents on file at the Facilities Office of said District for amounts set forth herein.

**2. BIDDER ACKNOWLEDGES THE FOLLOWING BID CLARIFICATION OR ADDENDUM:**

Number    Number    Number    Number    Number    Number    Number    Number

\_\_\_\_\_

Liberty High School Administration and Student Commons  
Liberty Union High School District

Acknowledge the inclusion of all addenda issued prior to bid in the blanks provided above. Your failure to do so may render your bid non-responsive.

3. TOTAL CASH PURCHASE PRICE IN WORDS & NUMBERS:

\_\_\_\_\_ DOLLARS  
(\$ \_\_\_\_\_)

4. ALTERNATE BIDS: The following amounts shall be added to or deducted from the Base Bid at the District's option. Alternates are fully described in the Specifications.

Alternate No. 1: ADD/DEDUCT \_\_\_\_\_ Dollars (\$\_\_\_\_\_)

5. TIME FOR COMPLETION: The District may give a notice to proceed within ninety (90) days of the award of the bid by the District. Once the Contractor has received the notice to proceed, the Contractor shall complete the work in the time specified in the Agreement. By submitting this bid, Contractor has thoroughly studied this Project and agrees that the Contract Time for this Project is adequate for the timely and proper completion of the Project. Further, Contractor has included in the analysis of the time required for this Project, Rain Days, Governmental Delays, and the requisite time to complete Punch List.

In the event that the District desires to postpone giving the notice to proceed beyond this ninety (90) day period, it is expressly understood that with reasonable notice to the Contractor, giving the notice to proceed may be postponed by the District. It is further expressly understood by the Contractor, that the Contractor shall not be entitled to any claim of additional compensation as a result of the postponement of giving the notice to proceed.

If the Contractor believes that a postponement will cause a hardship to it, the Contractor may terminate the contract with written notice to the District within ten (10) days after receipt by the Contractor of the District's notice of postponement. Should the Contractor terminate the Contract as a result of a notice of postponement, the District shall have the authority to award the Contract to the next lowest responsible bidder, if applicable.

It is understood that the District reserves the right to reject any or all bids and/or waive any irregularities or informalities in this bid or in the bid process. The Contractor understands that it may not withdraw this bid for a period of ninety (90) days after the date set for the opening of bids.

6. Attached is bid security in the amount of not less than ten percent (10%) of the bid:

Bid bond (10% of the Bid), certified check, or cashier's check (circle one)

7. The required List of Designated Subcontractors is attached hereto.

8. The required Non-Collusion Declaration is attached hereto.

9. The Substitution Request Form, if applicable, is attached hereto.

10. It is understood and agreed that if written notice of the acceptance of this bid is mailed, telegraphed, or delivered to the undersigned after the opening of the bid, and within the time this bid is required to remain open, or at any time thereafter before this bid is withdrawn, the undersigned will execute and deliver to the District a Contract in the form attached hereto in accordance with the bid as accepted, and that he or she

will also furnish and deliver to the District the Performance Bond and Payment Bond, all within five (5) calendar days after award of Contract, and that the work under the Contract shall be commenced by the undersigned bidder, if awarded the Contract, by the start date provided in the District's Notice to Proceed, and shall be completed by the Contractor in the time specified in the Contract Documents.

11. The names of all persons interested in the foregoing proposal as principals are as follows:

---

---

---

---

---

(IMPORTANT NOTICE: If bidder or other interested person is a corporation, state the legal name of such corporation, as well as the names of the president, secretary, treasurer, and manager thereof; if a co-partnership, state the true names of the firm, as well as the names of all individual co-partners comprising the firm; if bidder or other interested person is an individual, state the first and last names in full.)

12. PROTEST PROCEDURES. If there is a bid protest, the grounds shall be submitted as set forth in the Instructions to Bidders.

13. The undersigned bidder shall be licensed and shall provide the following California Contractor's license information:

License Number: \_\_\_\_\_

License Expiration Date: \_\_\_\_\_

Name on License: \_\_\_\_\_

Class of License: \_\_\_\_\_

DIR Registration Number: \_\_\_\_\_

If the bidder is a joint venture, each member of the joint venture must include the above information.

14. Time is of the essence regarding this Contract, therefore, in the event the bidder to whom the Contract is awarded fails or refuses to post the required bonds and return executed copies of the Agreement form within five (5) calendar days from the date of receiving the Notice of Award, the District may declare the bidder's bid deposit or bond forfeited as damages.

15. The bidder declares that he/she has carefully examined the location of the proposed Project, that he/she has examined the Contract Documents, including the Plans, General Conditions, Supplemental Conditions, Addenda, and Specifications, all others documents and requirements that are attached to and/or contained in the Project Manual, all other documents issued to bidders and read the accompanying instructions to bidders, and hereby proposes and agrees, if this proposal is accepted, to furnish all materials

and do all work required to complete the said work in accordance with the Contract Documents, in the time and manner therein prescribed for the unit cost and lump sum amounts set forth in this Bid Form.

16. DEBARMENT. In addition to seeking remedies for False Claims under Government Code section 12650 et seq. and Penal Code section 72, the District may debar a Contractor pursuant to Article 15 of the General Conditions if the Board, or the Board may designate a hearing officer who, in his or her discretion, finds the Contractor has done any of the following:

- a. Intentionally or with reckless disregard, violated any term of a contract with the District;
- b. Committed an act or omission which reflects on the Contractor's quality, fitness or capacity to perform work for the District;
- c. Committed an act or offense which indicates a lack of business integrity or business honesty; or
- d. Made or submitted a false claim against the District or any other public entity. (See Government Code section 12650, et seq., and Penal Code section 72)

17. DESIGNATION OF SUBCONTRACTORS. In compliance with the Subletting and Subcontracting Fair Practices Act (California Public Contract Code section 4100 et seq.) and any amendments thereof, each bidder shall list subcontractors on the District's form Subcontractor list. This subcontractor list shall be submitted with the bid and is a required form

I agree to receive service of notices at the e-mail address listed below.

I the below-indicated bidder, declare under penalty of perjury that the information provided and representations made in this bid are true and correct.

---

Proper Name of Company

---

Name of Bidder Representative

---

Street Address

---

City, State, and Zip

---

( )  
Phone Number

---

( )  
Fax Number

---

E-Mail

---

Liberty High School Administration and Student Commons  
Liberty Union High School District

By: \_\_\_\_\_ Date: \_\_\_\_\_  
Signature of Bidder Representative

**NOTE:** If bidder is a corporation, the legal name of the corporation shall be set forth above together with the signature of authorized officers or agents and the document shall bear the corporate seal; if bidder is a partnership, the true name of the firm shall be set forth above, together with the signature of the partner or partners authorized to sign contracts on behalf of the partnership; and if bidder is an individual, his signature shall be placed above.

All signatures must be made in permanent blue ink.

**CONTRACTOR'S CERTIFICATE REGARDING WORKERS' COMPENSATION**  
**FORM**

Labor Code section 3700 in relevant part provides:

Every employer except the State shall secure the payment of compensation in one or more of the following ways:

1. By being insured against liability to pay compensation by one or more insurers duly authorized to write compensation insurance in this State.
2. By securing from the Director of Industrial Relations a certificate of consent to self-insure, which may be given upon furnishing proof satisfactory to the Director of Industrial Relations of ability to self-insure and to pay any compensation that may become due to employees.
3. For any county, city, city and county, municipal corporation, public district, public agency, or any political subdivision of the state, including each member of a pooling arrangement under a joint exercise of powers agreement (but not the state itself), by securing from the Director of Industrial Relations a certificate of consent to self-insure against workers' compensation claims, which certificate may be given upon furnishing proof satisfactory to the director of ability to administer workers' compensation claims properly, and to pay workers' compensation claims that may become due to its employees. On or before March 31, 1979, a political subdivision of the state which, on December 31, 1978, was uninsured for its liability to pay compensation, shall file a properly completed and executed application for a certificate of consent to self-insure against workers' compensation claims. The certificate shall be issued and be subject to the provisions of Section 3702.

I am aware of the provisions of Labor Code section 3700 which require every employer to be insured against liability for workers' compensation or to undertake self-insurance in accordance with the provisions of that code, and I will comply with such provision before commencing the performance of the work of this Contract.

---

(Signature)

---

(Print)

---

(Date)

In accordance with Article 5 (commencing at section 1860), Chapter 1, Part 7, Division 2 of the Labor Code, the above certificate must be signed and submitted with the Contractor's bid.

**NON-COLLUSION DECLARATION**

The undersigned declares:

I am the \_\_\_\_\_ [Title] of \_\_\_\_\_ [Name of Company], the party making the foregoing bid.

The bid is not made in the interest of, or on behalf of, any undisclosed person, partnership, company, association, organization, or corporation. The bid is genuine and not collusive or sham. The bidder has not directly or indirectly induced or solicited any other bidder to put in a false or sham bid. The bidder has not directly or indirectly colluded, conspired, connived, or agreed with any bidder or anyone else to put in a sham bid, or to refrain from bidding. The bidder has not in any manner, directly or indirectly, sought by agreement, communication, or conference with anyone to fix the bid price of the bidder or any other bidder, or to fix any overhead, profit, or cost element of the bid price, or of that of any other bidder. All statements contained in the bid are true. The bidder has not, directly or indirectly, submitted his or her bid price or any breakdown thereof, or the contents thereof, or divulged information or data relative thereto, to any corporation, partnership, company, association, organization, bid depository, or to any member or agent thereof, to effectuate a collusive or sham bid, and has not paid, and will not pay, any person or entity for such purpose.

Any person executing this declaration on behalf of a bidder that is a corporation, partnership, joint venture, limited liability company, limited liability partnership, or any other entity, hereby represents that he or she has full power to execute, and does execute, this declaration on behalf of the bidder.

I declare under penalty of perjury under the laws of the State of California that the foregoing is true and correct and that this declaration is executed on \_\_\_\_\_ [Date], at \_\_\_\_\_ [City], \_\_\_\_\_ [State].

Signed: \_\_\_\_\_

Typed Name: \_\_\_\_\_

**BID GUARANTEE FORM**

**(Use only when not using a Bid Bond)**

Accompanying this proposal is a cashier's check payable to the order of the Liberty Union High School District or a certified check payable to the order of the Liberty Union High School District in an amount equal to ten percent (10%) of the base bid and alternates (\$\_\_\_\_\_).

The proceeds of this check shall become the property of said District, if, this proposal shall be accepted by the District through the District's Governing Board, and the undersigned fails to execute a Contract with and furnish the sureties required by the District within the required time; otherwise, said check is to be returned to the undersigned.

---

Bidder

Note: Use this form, in lieu of Bid Bond form, when a cashier's check or certified check is accompanying the bid



**BID BOND FORM**

KNOW ALL MEN BY THESE PRESENT that we, the undersigned, (hereafter called "Principal"), and \_\_\_\_\_ (hereafter called "Surety"), are hereby held and firmly bound unto the Liberty Union High School District (hereafter called "District") in the sum of \_\_\_\_\_ (\$\_\_\_\_\_) for the payment of which, well and truly to be made, we hereby jointly and severally bind ourselves, successors, and assigns.

SIGNED this \_\_\_\_\_ day of \_\_\_\_\_, 20\_\_.

The condition of the above obligation is such that whereas the Principal has submitted to the District a certain Bid, attached hereto and hereby made a part hereof, to enter into a Contract in \_\_\_\_\_ writing \_\_\_\_\_ for \_\_\_\_\_ the \_\_\_\_\_ construction \_\_\_\_\_ of \_\_\_\_\_.

NOW, THEREFORE,

- a. If said Bid is rejected, or
- b. If said Bid is accepted and the Principal executes and delivers a Contract or the attached Agreement form within five (5) calendar days after acceptance (properly completed in accordance with said Bid), and furnishes bonds for his faithful performance of said Contract and for payment of all persons performing labor or furnishing materials in connection therewith,

Then this obligation shall be void; otherwise, the same shall remain in force and effect.

Surety, for value received, hereby stipulates and agrees that no change, extension of time, alteration, or addition to the terms of the Contract, or the call for bids, or the work to be performed thereunder, or the specifications accompanying the same, shall in anyway affect its obligation under this bond, and it does hereby waive notice of any such change, extension of time, alteration, or addition to the terms of said Contract, or the call for bids, or the work, or to the specifications.

In the event suit is brought upon this bond by the District and judgment is recovered, the Surety shall pay all costs incurred by the District in such suit, including without limitation, attorneys' fees to be fixed by the court.

IN WITNESS WHEREOF, Principal and Surety have hereunto set their hands and seals, and such of them as are corporations have caused their corporate seals to be hereto affixed and these presents to be signed by their proper officers, on the day and year first set forth above.

(Corporate Seal)

By \_\_\_\_\_

Principal's Signature

\_\_\_\_\_  
Typed or Printed Name

\_\_\_\_\_  
Principal's Title

(Corporate Seal)

By \_\_\_\_\_

Surety's Signature

\_\_\_\_\_  
Typed or Printed Name

\_\_\_\_\_  
Title

(Attached Attorney in Fact Certificate)

\_\_\_\_\_  
Surety's Name

\_\_\_\_\_  
Surety's Address

\_\_\_\_\_  
Surety's Phone Number

**IMPORTANT:**

Surety companies executing bonds must possess a certificate of authority from the California Insurance Commissioner authorizing them to write surety insurance defined in California Insurance Code section 105, and if the work or project is financed, in whole or in part, with federal, grant, or loan funds, it must also appear on the Treasury Department's most current list (Circular 570 as amended).

**THIS IS A REQUIRED FORM.**

Any claims under this bond may be addressed to:

(Name and Address of Surety)

---

---

---

(Name and Address of agent or representative for service of process in California if different from above)

---

---

---

(Telephone Number of Surety and agent or representative for service of process in California).

---

---

---



**ACKNOWLEDGMENT OF BIDDING PRACTICES REGARDING INDEMNITY FORM**

TO: Liberty Union High School District

RE: Project Number \_\_\_\_\_

Construction Contract for \_\_\_\_\_

Please be advised that with respect to the above-referenced Project the undersigned Contractor on behalf of itself and all subcontractors hereby waives the benefits and protection of Labor Code section 3864, which provides:

“If an action as provided in this chapter is prosecuted by the employee, the employer, or both jointly against the third person results in judgment against such third person, the employer shall have no liability to reimburse or hold such third person harmless on such judgment or settlement in the absence of a written agreement to do so executed prior to the injury.”

This Agreement has been signed by an authorized representative of the contracting party and shall be binding upon its successors and assignees. The undersigned further agrees to promptly notify the District of any changes of ownership of the contracting party or any subcontractor while this Agreement is in force.

\_\_\_\_\_  
Contracting Party

\_\_\_\_\_  
Name of Agent/Title

**DISABLED VETERAN BUSINESS ENTERPRISE (DVBE) PARTICIPATION**  
**STATEMENT**

Each bidder must complete this form in order to comply with the Liberty Union High School District (“District”) policy for participation of disabled veteran business enterprises (School District projects funded in whole or in part by the State of California pursuant to the Leroy F. Greene School Facilities Act of 1998. (Education Code §17070.10, *et seq.*)

Project Name: \_\_\_\_\_

Bid No.: \_\_\_\_\_

DSA No.: \_\_\_\_\_

The undersigned, on behalf of the Contractor named below, certifies that the Contractor has made reasonable efforts to secure participation by DVBE in the Contract to be awarded for the above-referenced Bid No., including participation by DVBE subcontractors and/or material suppliers. **Check only one of the following:**

The Contractor was unable after reasonable efforts to secure DVBE participation in the Contract for the above-referenced Project/Bid No. However, the Contractor will use DVBE services if the opportunity arises at any time during construction of the Project. Upon completion of the Project, the Contractor will report to the District the total dollar amount of DVBE participation in any Contract awarded to Contractor, and in any change orders, for the above-referenced Project.

The Contractor has secured DVBE participation in the Contract for the above referenced Project/Bid No., and anticipates that such DVBE participation will equal approximately \_\_\_\_\_dollars (\$ \_\_\_\_\_ ), which represents approximately \_\_\_\_\_percent (\_\_\_%) of the total Contract for such Project. Upon completion of the Project, Contractor will report to the District the actual total dollar amount of DVBE participation in the Contract awarded to Contractor, and in any change orders, for such Project

Company: \_\_\_\_\_

Name: \_\_\_\_\_

Title: \_\_\_\_\_

Signature: \_\_\_\_\_

Date: \_\_\_\_\_

**CONTRACTOR’S CERTIFICATE REGARDING DRUG-FREE WORKPLACE**

This Drug-Free Workplace Certification form is required from all successful bidders pursuant to the requirements mandated by Government Code section 8350 et seq., the Drug-Free Workplace Act of 1990. The Drug-Free Workplace Act of 1990 requires that every person or organization awarded a contract or grant for the procurement of any property or service from any State agency must certify that it will provide a drug-free workplace by performing certain specified acts. In addition, the Act provides that each contract or grant awarded by a State agency may be subject to suspension of payments or termination of the contract or grant, and the Contractor or grantee may be subject to debarment from future contracting, if the contracting agency determines that specified acts have occurred.

Pursuant to Government Code section 8355, every person or organization awarded a contract or grant from a State agency shall certify that it will provide a drug-free workplace by doing all of the following:

1. Publishing a statement, notifying employees that the unlawful manufacture, distribution, dispensation, possession, or use of a controlled substance is prohibited in the person’s or organization’s workplace, and specifying actions which will be taken against employees for violations of the prohibition.
2. Establishing a drug-free awareness program to inform employees about all of the following:
  - a. The dangers of drug abuse in the workplace;
  - b. The person’s or organization’s policy of maintaining a drug-free workplace;
  - c. The availability of drug counseling, rehabilitation and employee-assistance programs; and
  - d. The penalties that may be imposed upon employees for drug abuse violations;
3. Requiring that each employee engaged in the performance of the contract or grant be given a copy of the statement required by subdivision (a) and that, as a condition of employment on the contract or grant, the employee agrees to abide by the terms of the statement.

I, the undersigned, agree to fulfill the terms and requirements of Government Code section 8355 listed above and will (a) publish a statement notifying employees concerning the prohibition of controlled substance at the workplace, (b) establish a drug-free awareness program, and (c) require each employee engaged in the performance of the contract be given a copy of the statement required by section 8355(a) and require such employee agree to abide by the terms of that statement.

I also understand that if the Liberty Union High School District determines that I have either (a) made a false certification herein, or (b) violated this certification by failing to carry out the requirements of Section 8355, that the contract awarded herein is subject to termination, suspension of payments, or both. I further understand that, should I violate the terms of the Drug-Free Workplace Act of 1990, I may be subject to debarment in accordance with the requirements of Section 8350 et seq.

I acknowledge that I am aware of the provisions of Government Code section 8350 et seq. and hereby certify that I will adhere to the requirements of the Drug-Free Workplace Act of 1990.

DATE: \_\_\_\_\_

\_\_\_\_\_  
CONTRACTOR

By: \_\_\_\_\_  
Signature

**CONTRACTOR’S CERTIFICATE REGARDING ALCOHOLIC BEVERAGE AND  
TOBACCO-FREE CAMPUS POLICY**

The Contractor agrees that it will abide by and implement the District’s Alcoholic Beverage and Tobacco-Free Campus Policy, which prohibits the use of alcoholic beverages and tobacco products, of any kind and at any time, in District-owned or leased buildings, on DISTRICT property and in DISTRICT vehicles. The Contractor shall procure signs stating “ALCOHOLIC BEVERAGE AND TOBACCO USE IS PROHIBITED” and shall ensure that these signs are prominently displayed in all entrances to school property at all times.

DATE: \_\_\_\_\_

\_\_\_\_\_

CONTRACTOR

By: \_\_\_\_\_

Signature



[End of Bid Documents to be Submitted with Bid]

**AGREEMENT FORM**

**THIS AGREEMENT**, entered into this \_\_\_\_ day of \_\_\_\_\_, 20\_\_ in the County of Contra Costa of the State of California, by and between the Liberty Union High School District, hereinafter called the “District”, and \_\_\_\_\_, hereinafter called the “Contractor”.

**WITNESSETH** that the District and the Contractor for the consideration stated herein agree as follows:

**ARTICLE 1 - SCOPE OF WORK:** The Contractor shall furnish all labor, materials, equipment, tools, and utility and transportation services, and perform and complete all work required in connection with Administration and Student Commons (“Project”) in strict accordance with the Contract Documents enumerated in Article 7 below. The Contractor shall be liable to the District for any damages arising as a result of a failure to comply with that obligation, and the Contractor shall not be excused with respect to any failure to so comply by an act or omission of the Architect, Engineer, Inspector, Division of the State Architect (DSA), or representative of any of them, unless such act or omission actually prevents the Contractor from fully complying with the Contract Documents and the Contractor protests, in accordance with the Contract Documents, that the act or omission is preventing the Contractor from fully complying with the Contract Documents. Such protest shall not be effective unless reduced to writing and filed with the District office within seven (7) days of the date of occurrence of such act or omission preventing the Contractor from fully complying with the Contract Documents.

**ARTICLE 2 - TIME OF COMPLETION:** The District may give notice to proceed within ninety (90) days of the award of the bid by the District. Once the Contractor has received a notice to proceed, the Contractor shall reach Substantial Completion (See Article 1.1.46) of the Work within the days noted in the milestone schedule from receipt of the Notice to Proceed. This shall be called Contract Time. (See Article 8.1.1). It is expressly understood that time is of the essence.

Contractor has thoroughly studied the Project and has satisfied itself that the time period for this Project was adequate for the timely and proper completion of the Project within each milestone and within the Contract time. Further, Contractor has included in the analysis of the time required for this Project, items set forth in General Conditions Article 8.3.2.1, Submittal Schedules, Rain Day Float, and Governmental Delay Float.

In the event that the District desires to postpone giving the notice to proceed beyond this ninety (90) day period, it is expressly understood that with reasonable notice to the Contractor, giving the notice to proceed may be postponed by the District. It is further expressly understood by the Contractor, that the Contractor shall not be entitled to any claim of additional compensation as a result of the District’s postponement of giving the notice to proceed.

If the Contractor believes that a postponement will cause hardship to it, the Contractor may terminate the Contract with written notice to the District within ten (10) days after receipt by the Contractor of the District’s notice of postponement. It is further understood by the Contractor that in the event that the Contractor terminates the Contract as a result of postponement by the District, the District shall only be obligated to pay the Contractor for the work performed by the Contractor at the time of notification of postponement. Should the Contractor terminate the Contract as a result of a notice of postponement, the District shall have the authority to award the Contract to the next lowest responsible bidder.

**ARTICLE 3 - LIQUIDATED DAMAGES:** It being impracticable and infeasible to determine the amount of actual damage, it is agreed that the Contractor will pay the District the sum as noted in the milestone schedule per calendar day for each and every day of delay beyond the Contract Time set forth in Article 2 of this Agreement (inclusive of Milestones that are critical on the critical path or noted as critical to the District) as liquidated damages and not as a penalty or forfeiture. In the event Liquidated Damages are not paid, the Contractor further agrees that the District may deduct such amount thereof from any money due or that may become due the Contractor under the Contract (See Article 9.6 and 2.2 of the General Conditions).

**ARTICLE 4 - CONTRACT PRICE:** The District shall pay to the Contractor as full consideration for the faithful performance of the Contract, subject to any additions or deductions as provided in the Contract Documents, the sum of \_\_\_\_\_ DOLLARS (\$ \_\_\_\_\_), said sum being the total amount stipulated in the Bid Contractor submitted. Payment shall be made as set forth in the General Conditions.

Should any Change Order result in an increase in the Contract Price, the cost of such Change Order shall be agreed to in advance by the Contractor and the District, subject to the monetary limitations set forth in Public Contract Code section 20118.4. In the event that the Contractor proceeds with a Change in work without an agreement between the District and Contractor regarding the cost of a Change Order, the Contractor waives any Claim of additional compensation for such additional work.

**ARTICLE 5 - HOLD HARMLESS AGREEMENT:** Contractor shall defend, indemnify and hold harmless District, Architect, Inspector, the State of California and their officers, employees, agents and independent contractors from all liabilities, claims, actions, liens, judgments, demands, damages, losses, costs or expenses of any kind arising from death, personal injury, property damage or other cause based or asserted upon any act, omission, or breach connected with or arising from the progress of Work or performance of service under this Agreement or the Contract Documents. As part of this indemnity, Contractor shall protect and defend, at its own expense, District, Architect, Construction Manager, Inspector, the State of California and their officers, employees, agents and independent contractors from any legal action including attorney's fees or other proceeding based upon such act, omission, breach or as otherwise required by this Article.

Furthermore, Contractor agrees to and does hereby defend, indemnify and hold harmless District, Architect, Construction Manager, Inspector, the State of California and their officers, employees, agents and independent contractors from every claim or demand made, and every liability, loss, damage, expense or attorney's fees of any nature whatsoever, which may be incurred by reason of:

(a) Liability for (1) death or bodily injury to persons; (2) damage or injury to, loss (including theft), or loss of use of, any property; (3) any failure or alleged failure to comply with any provision of law or the Contract Documents; or (4) any other loss, damage or expense, sustained by any person, firm or corporation or in connection with the Work called for in this Agreement or the Contract Documents, except for liability resulting from the sole or active negligence, or the willful misconduct of the District.

(b) Any bodily injury to or death of persons or damage to property caused by any act, omission or breach of Contractor or any person, firm or corporation employed by Contractor, either directly or by independent contract, including all damages or injury to or death of persons, loss (including theft) or loss of use of any property, sustained by any person, firm or corporation, including the District, arising out of or in any way connected with Work covered by this Agreement or the Contract Documents, whether said injury or damage occurs either on or off District property, but not for any loss, injury, death or damages caused by the sole or active negligence or willful misconduct of the District.

(c) Any dispute between Contractor and Contractor's subcontractors/supplies/ Sureties, including, but not limited to, any failure or alleged failure of the Contractor (or any person hired or employed directly or indirectly by the Contractor) to pay any Subcontractor or Materialman of any tier or any other person employed in connection with the Work and/or filing of any stop notice or mechanic's lien claims.

(d) Any claims, allegations, penalties, assessments, or liabilities to the extent caused by the Contractor's failure or the failure of any Subcontractor of any tier, to fully comply with the DIR registration requirements under Labor Code section 1725.5 at all times during the performance of any Work on the Project and shall reimburse the District for any penalties assessed against the District arising from any failure by the Contractor or any Subcontractor of any tier from complying with Labor Code sections 1725.5 and 1771.1. Nothing in this paragraph, however, shall require the Contractor or any Subcontractor to be liable to the District or indemnify the District for any penalties caused by the District in accordance with Labor Code section 1773.3 (g).

Contractor, at its own expense, cost, and risk, shall defend any and all claims, actions, suits, or other proceedings that may be brought or instituted against the District, its officers, agents or employees, on account of or founded upon any cause, damage, or injury identified herein Article 5 and shall pay or satisfy any judgment that may be rendered against the District, its officers, agents or employees in any action, suit or other proceedings as a result thereof.

The Contractor's and Subcontractors' obligation to defend, indemnify and hold harmless the Owner, Architect, Inspector, the State of California and their officers, employees, agents and independent contractors hereunder shall include, without limitation, any and all claims, damages, and costs for the following: (1) any damages or injury to or death of any person, and damage or injury to, loss (including theft), or loss of use of, any property; (2) breach of any warranty, express or implied; (3) failure of the Contractor or Subcontractors to comply with any applicable governmental law, rule, regulation, or other requirement; (4) products installed in or used in connection with the Work; and (5) any claims of violation of the Americans with Disabilities Act ("ADA").

**ARTICLE 6 - PROVISIONS REQUIRED BY LAW:** Each and every provision of law and clause required to be inserted in this Contract shall be deemed to be inserted herein, and this Contract shall be read and enforced as though it were included herein, and if through mistake or otherwise any such provision is not inserted or is not inserted correctly, then upon application of either party the Contract shall forthwith be physically amended to make such insertion or correction.

**ARTICLE 7 - COMPONENT PARTS OF THE CONTRACT:** The Contract entered into by this Agreement consists of the following Contract Documents, all of which are component parts of the Contract as if herein set out in full or attached hereto.

Notice Inviting Bids  
Instructions to Bidders  
Designation of Subcontractors  
Non-Collusion Declaration  
Bid Guarantee Form  
Bid Bond  
Bid Form  
Contractor's Certificate Regarding Worker's Compensation  
Acknowledgment of Bidding Practices Regarding Indemnity

DVBE Participation Statement and Close-Out Forms  
 Agreement Form  
 Payment Bond  
 Performance Bond  
 Guarantee  
 Escrow Agreement for Security Deposit In Lieu of Retention  
 Workers' Compensation/Employers Liability Endorsement  
 General Liability Endorsement  
 Automobile Liability Endorsement  
 Contractor's Certificate Regarding Drug-Free Workplace  
 Contractor's Certificate Regarding Alcohol and Tobacco  
 Contractor's Certificate Regarding Background Checks  
 General Conditions  
 Supplementary and Special Conditions  
 Specifications  
 All Bid Clarifications and Addenda as Issued  
 Drawings/Plans  
 Substitution Request Form  
 Requirements, Reports and/or Documents in the Project Manual or Other Documents Issued to Bidders

All of the above named Contract Documents are intended to be complementary. Work required by one of the above named Contract Documents and not by others shall be done as if required by all.

**ARTICLE 8 - PREVAILING WAGES:** Wage rates for this Project shall be in accordance with the general prevailing rate of holiday and overtime work in the locality in which the work is to be performed for each craft, classification, or type of work needed to execute the Contract as determined by the Director of the Department of Industrial Relations. Copies of schedules of rates so determined by the Director of the Department of Industrial Relations are on file at the administrative office of the District and are also available from the Director of the Department of Industrial Relations. Monitoring and enforcement of the prevailing wage laws and related requirements will be performed by the Labor Commissioner/ Department of Labor Standards Enforcement (DLSE).

The following are hereby referenced and made a part of this Agreement and Contractor stipulates to the provisions contained therein.

1. Chapter 1 of Part 7 of Division 2 of the Labor Code (Section 1720 et seq.)
2. California Code of Regulations, Title 8, Chapter 8, Subchapters 3 through 6 (Section 16000 et seq.)

**ARTICLE 9 - RECORD AUDIT:** In accordance with Government Code section 8546.7 (and Davis Bacon, if applicable) and Article 13.11 of the General Conditions, records of both the District and the Contractor shall be subject to examination and audit for a period of five (5) years after a Final Retention Payment or the Recording of a Notice of Completion, whichever occurs first.

**ARTICLE 10 - CONTRACTOR'S LICENSE:** The Contractor must possess throughout the Project a Class A or B Contractor's License, issued by the State of California, which must be current and in good standing.

**IN WITNESS WHEREOF**, this Agreement has been duly executed by the above named parties, on the day and year first above written.

LIBERTY UNION HIGH SCHOOL DISTRICT:

CONTRACTOR:

\_\_\_\_\_  
Type or Printed Name

\_\_\_\_\_  
Typed or Printed Name

\_\_\_\_\_  
Title (Authorized Officers or Agents)

\_\_\_\_\_  
Title

\_\_\_\_\_  
Signature

\_\_\_\_\_  
Signature

Dated: \_\_\_\_\_

Dated: \_\_\_\_\_

**(CORPORATE SEAL)**

**PAYMENT BOND**

**(CALIFORNIA PUBLIC WORK)**

KNOW ALL MEN BY THESE PRESENTS:

THAT WHEREAS, the LIBERTY UNION HIGH SCHOOL DISTRICT (sometimes referred to hereinafter as "Obligee") has awarded to \_\_\_\_\_ (hereinafter designated as the "Principal" or "Contractor"), an agreement for the work described as follows: \_\_\_\_\_ (hereinafter referred to as the "Public Work"); and

WHEREAS, said Contractor is required to furnish a bond in connection with said Contract, and pursuant to California Civil Code section 9550;

NOW, THEREFORE, We, \_\_\_\_\_, the undersigned Contractor, as Principal; and \_\_\_\_\_, a corporation organized and existing under the laws of the State of \_\_\_\_\_, and duly authorized to transact business under the laws of the State of California, as Surety, are held and firmly bound unto the LIBERTY UNION HIGH SCHOOL DISTRICT and to any and all persons, companies, or corporations entitled by law to file stop notices under California Civil Code section 9100, or any person, company, or corporation entitled to make a claim on this bond, in the sum of \_\_\_\_\_ Dollars (\$ \_\_\_\_\_), such sum being not less than one hundred percent (100%) of the total amount payable by said Obligee under the terms of said Contract, for which payment will and truly to be made, we bind ourselves, our heirs, executors and administrators, successors and assigns, jointly and severally, firmly by these presents.

THE CONDITION OF THIS OBLIGATION IS SUCH that if said Principal, its heirs, executors, administrators, successors, or assigns, or subcontractor, shall fail to pay any person or persons named in Civil Code section 9100; or fail to pay for any materials, provisions, or other supplies, used in, upon, for, or about the performance of the work contracted to be done, or for any work or labor thereon of any kind, or for amounts due under the Unemployment Insurance Code, with respect to work or labor thereon of any kind; or shall fail to deduct, withhold, and pay over to the Employment Development Department, any amounts required to be deducted, withheld, and paid over by Unemployment Insurance Code section 13020 with respect to work and labor thereon of any kind, then said Surety will pay for the same, in an amount not exceeding the amount herein above set forth, and in the event suit is brought upon this bond, also will pay such reasonable attorneys' fees as shall be fixed by the court, awarded and taxed as provided in California Civil Code section 9550 et seq.

This bond shall inure to the benefit of any person named in Civil Code section 9100 giving such person or his/her assigns a right of action in any suit brought upon this bond.

It is further stipulated and agreed that the Surety of this bond shall not be exonerated or released from the obligation of the bond by any change, extension of time for performance, addition, alteration or modification in, to, or of any contract, plans, or specifications, or agreement pertaining or relating to any scheme or work of improvement herein above described; or pertaining or relating to the furnishing of labor, materials, or equipment therefor; nor by any change or modification of any terms of payment or extension of time for payment pertaining or relating to any scheme or work of improvement herein above described; nor by any rescission or attempted rescission of the contract, agreement or bond; nor by any conditions

precedent or subsequent in the bond attempting to limit the right of recovery of claimants otherwise entitled to recover under any such contract or agreement or under the bond; nor by any fraud practiced by any person other than the claimant seeking to recover on the bond; and that this bond be construed most strongly against the Surety and in favor of all persons for whose benefit such bond is given; and under no circumstances shall the Surety be released from liability to those for whose benefit such bond has been given, by reason of any breach of contract between the Obligee and the Contractor or on the part of any obligee named in such bond; that the sole condition of recovery shall be that the claimant is a person described in California Civil Code section 9100, and who has not been paid the full amount of his or her claim; and that the Surety does hereby waive notice of any such change, extension of time, addition, alteration or modification herein mentioned.

IN WITNESS WHEREOF this instrument has been duly executed by the Principal and Surety above named, on the \_\_\_\_\_ day of \_\_\_\_\_, 20\_\_.

PRINCIPAL/CONTRACTOR:

\_\_\_\_\_

By: \_\_\_\_\_

SURETY:

\_\_\_\_\_

By: \_\_\_\_\_

Attorney-in-Fact





**PERFORMANCE BOND**  
**(CALIFORNIA PUBLIC WORK)**

KNOW ALL MEN BY THESE PRESENTS:

THAT WHEREAS, the LIBERTY UNION HIGH SCHOOL DISTRICT (sometimes referred to hereinafter as "Obligee") has awarded to \_\_\_\_\_ (hereinafter designated as the "Principal" or "Contractor"), an agreement for the work described as follows: \_\_\_\_\_ (hereinafter referred to as the "Public Work"); and

WHEREAS, the work to be performed by the Contractor is more particularly set forth in that certain contract for said Public Work dated \_\_\_\_\_, (hereinafter referred to as the "Contract"), which Contract is incorporated herein by this reference; and

WHEREAS, the Contractor is required by said Contract to perform the terms thereof and to provide a bond both for the performance and guaranty thereof.

NOW, THEREFORE, we, \_\_\_\_\_, the undersigned Contractor, as Principal, and \_\_\_\_\_, a corporation organized and existing under the laws of the State of \_\_\_\_\_, and duly authorized to transact business under the laws of the State of California, as Surety, are held and firmly bound unto the LIBERTY UNION HIGH SCHOOL DISTRICT in the sum of \_\_\_\_\_ Dollars (\$ \_\_\_\_\_), said sum being not less than one hundred percent (100%) of the total amount payable by said Obligee under the terms of said Contract, for which amount well and truly to be made, we bind ourselves, our heirs, executors, administrators, successors, and assigns, jointly and severally, firmly by these presents.

THE CONDITION OF THIS OBLIGATION IS SUCH THAT, if the bounded Contractor, his or her heirs, executors, administrators, successors or assigns, shall in all things stand to and abide by, and well and truly keep and perform the covenants, conditions, and agreements in said Contract and any alteration thereof made as therein provided, on his or her part, to be kept and performed at the time and in the manner therein specified, and in all respects according to their intent and meaning; and shall faithfully fulfill guarantees of all materials and workmanship; and indemnify, defend and save harmless the Obligee, its officers and agents, as stipulated in said Contract, then this obligation shall become null and void; otherwise it shall be and remain in full force and effect.

The Surety, for value received, hereby stipulates and agrees that it shall not be exonerated or released from the obligation of this bond (either by total exoneration or pro tanto) by any change, extension of time, alteration in or addition to the terms of the contract or to the work to be performed there under or the specifications accompanying the same, nor by any change or modification to any terms of payment or extension of time for any payment pertaining or relating to any scheme of work of improvement under the contract. Surety also stipulates and agrees that it shall not be exonerated or released from the obligation of this bond (either by total exoneration or pro tanto) by any overpayment or underpayment by the Obligee that is based upon estimates approved by the Architect. The Surety stipulates and agrees that none of the aforementioned changes, modifications, alterations, additions, extension of time or actions shall in any way affect its obligation on this bond, and it does hereby waive notice of any such changes, modifications,

alterations, additions or extension of time to the terms of the contract, or to the work, or the specifications as well notice of any other actions that result in the foregoing.

Whenever Principal shall be, and is declared by the Oblige to be, in default under the Contract, the Surety shall promptly either remedy the default, or shall promptly take over and complete the Contract through its agents or independent contractors, subject to acceptance and approval of such agents or independent contractors by Oblige as hereinafter set forth, in accordance with its terms and conditions and to pay and perform all obligations of Principal under the Contract, including, without limitation, all obligations with respect to warranties, guarantees and the payment of Liquidated Damages; or, at Oblige's sole discretion and election, Surety shall obtain a bid or bids for completing the Contract in accordance with its terms and conditions, and upon determination by Oblige of the lowest responsible bidder, arrange for a contract between such bidder and the Oblige and make available as Work progresses (even though there should be a default or succession of defaults under the contract or contracts of completion arranged under this paragraph) sufficient funds to pay the cost of completion less the "balance of the Contract Price" (as hereinafter defined), and to pay and perform all obligations of Principal under the Contract, including, without limitation, all obligations with respect to warranties, guarantees and the payment of Liquidated Damages. The term "balance of the Contract Price," as used in this paragraph, shall mean the total amount payable to Principal by the Oblige under the Contract and any modifications thereto, less the amount previously paid by the Oblige to the Principal, less any withholdings by the Oblige allowed under the Contract. Oblige shall not be required or obligated to accept a tender of a completion contractor from the Surety.

Surety expressly agrees that the Oblige may reject any agent or contractor which may be proposed by Surety in fulfillment of its obligations in the event of default by the Principal. Unless otherwise agreed by Oblige, in its sole discretion, Surety shall not utilize Principal in completing the Contract nor shall Surety accept a bid from Principal for completion of the work in the event of default by the Principal.

No final settlement between the Oblige and the Contractor shall abridge the right of any beneficiary hereunder, whose claim may be unsatisfied.

The Surety shall remain responsible and liable for all patent and latent defects that arise out of or relate to the Contractor's failure and/or inability to properly complete the Public Work as required by the Contract and the Contract Documents. The obligation of the Surety hereunder shall continue so long as any obligation of the Contractor remains.

Contractor and Surety agree that if the Oblige is required to engage the services of an attorney in connection with enforcement of the bond, Contractor and Surety shall pay Oblige's reasonable attorneys' fees incurred, with or without suit, in addition to the above sum.

In the event suit is brought upon this bond by the Oblige and judgment is recovered, the Surety shall pay all costs incurred by the Oblige in such suit, including reasonable attorneys' fees to be fixed by the Court.

IN WITNESS WHEREOF, we have hereunto set our hands and seals this \_\_\_\_\_ day of \_\_\_\_\_, 20\_\_.

PRINCIPAL/CONTRACTOR:

\_\_\_\_\_

By: \_\_\_\_\_

SURETY:

\_\_\_\_\_

By: \_\_\_\_\_

Attorney-in-Fact

The rate of premium on this bond is \_\_\_\_\_ per thousand.

The total amount of premium charged: \$ \_\_\_\_\_ (This must be filled in by a corporate surety).

**IMPORTANT: THIS IS A REQUIRED FORM.**

Surety companies executing bonds must possess a certificate of authority from the California Insurance Commissioner authorizing them to write surety insurance defined in California Insurance Code section 105, and if the work or project is financed, in whole or in part, with federal, grant or loan funds, Surety's name must also appear on the Treasury Department's most current list (Circular 570 as amended).

Any claims under this bond may be addressed to:

(Name and Address of Surety)

(Name and Address of agent or representative for service for service of process in California)

\_\_\_\_\_

\_\_\_\_\_

\_\_\_\_\_

\_\_\_\_\_

Telephone: \_\_\_\_\_

Telephone: \_\_\_\_\_



**GUARANTEE**

Guarantee for \_\_\_\_\_ . We hereby guarantee that the \_\_\_\_\_, which we have installed in \_\_\_\_\_ has been done in accordance with the Contract Documents, including without limitation, the drawings and specifications, and that the work as installed will fulfill the requirements included in the bid documents. The undersigned and its surety agrees to repair or replace any or all such work, together with any other adjacent work, which may be displaced in connection with such replacement, that may prove to be defective in workmanship or material within a period of one (1) year from the date of the Notice of Completion of the above-mentioned structure by the Liberty Union High School District, ordinary wear and tear and unusual abuse or neglect excepted.

In the event the undersigned or its surety fails to comply with the above-mentioned conditions within a reasonable period of time, as determined by the District, but not later than ten (10) days after being notified in writing by the District or within forty eight (48) hours in the case of an emergency or urgent matter, the undersigned and its surety authorizes the District to proceed to have said defects repaired and made good at the expense of the undersigned and its surety, who will pay the costs and charges therefor upon demand. The undersigned and its surety shall be jointly and severally liable for any costs arising from the District's enforcement of this Guarantee.

Countersigned

\_\_\_\_\_  
(Proper Name)

\_\_\_\_\_  
(Proper Name)

By: \_\_\_\_\_

By: \_\_\_\_\_

\_\_\_\_\_  
(Signature of Subcontractor or Contractor)

\_\_\_\_\_  
(Signature of General Contractor if for Subcontractor)

Representatives to be contacted for service:

Name: \_\_\_\_\_

Address: \_\_\_\_\_

\_\_\_\_\_

Phone Number: \_\_\_\_\_

## **ESCROW AGREEMENT FOR SECURITY DEPOSITS IN LIEU OF RETENTION**

This Escrow Agreement is made and entered into by and between the Liberty Union High School District Oak Street, Brentwood, CA 94513 hereinafter called "Owner", and \_\_\_\_\_ whose address is \_\_\_\_\_, hereinafter called "Contractor", and \_\_\_\_\_ whose address is \_\_\_\_\_, hereinafter called "Escrow Agent".

For the consideration hereinafter set forth, the Owner, Contractor and Escrow Agent agree as follows:

1. Pursuant to Section 22300 of the Public Contract Code of the State of California, Contractor has the option to deposit securities with Escrow Agent as a substitute for Retention earnings required to be withheld by Owner pursuant to the Construction Contract entered into between the Owner and Contractor for \_\_\_\_\_ in the amount of \_\_\_\_\_ dated \_\_\_\_\_ (hereinafter referred to as the "Contract"). Alternatively, on written request of the Contractor, the Owner shall make payments of the Retention earnings directly to the escrow agent. When Contractor deposits the securities as a substitute for Contract earnings, the Escrow Agent shall notify the Owner within ten (10) days of deposit. The market value of the securities at the time of the substitution shall be at least equal to the cash amount then required to be withheld as Retention under the terms of the Contract between the Owner and Contractor. Securities shall be held in the name of the Owner, and shall designate the Contractor as beneficial owner.
2. The Owner shall make progress payments to the Contractor for such funds which otherwise would be withheld from progress payments pursuant to the Contract provisions, provided that the Escrow Agent holds securities in the form and amount specified above.
3. When the Owner makes payments of Retentions earned directly to the Escrow Agent, the Escrow Agent shall hold them for the benefit of the Contractor until such time as the escrow created under this Contract is terminated. The Contractor may direct the investment of the payments into securities. All terms and conditions of this Agreement and the rights and responsibilities of the parties shall be equally applicable and binding when the Owner pays the Escrow Agent directly.
4. Contractor shall be responsible for paying all fees for the expenses incurred by Escrow Agent in administering the Escrow Account and all expenses of the Owner. These expenses and payment terms shall be determined by the Owner, Contractor, and Escrow Agent.
5. The interest earned on the securities or the money market accounts held in escrow and all interest earned on that interest shall be for the sole account of Contractor and shall be subject to withdrawal by Contractor at any time and from time to time without notice to the Owner.
6. Contractor shall have the right to withdraw all or any part of the principal in the Escrow Account only by written notice to Escrow Agent accompanied by written authorization from the Owner to the Escrow Agent that Owner consents to the withdrawal of the amount sought to be withdrawn by Contractor.
7. The Owner shall have a right to draw upon the securities in the event of default by the Contractor. Upon seven (7) days' written notice to the Escrow Agent from the Owner of the notice of default under Article 2.2, Article 9.6 or Article 14, the Escrow Agent shall immediately convert the securities to cash and shall distribute the cash as instructed by the Owner.

8. Upon receipt of written notification from the Owner certifying that the Contract is final and complete, and that the Contractor has complied with all requirements and procedures applicable to the Contract, Escrow Agent shall release to Contractor all securities and interest on deposit less escrow fees and charges of the Escrow Account. The escrow shall be closed immediately upon disbursement of all moneys and securities on deposit and payment of fees and charges.

9. Escrow Agent shall rely on the written notifications from the Owner and the Contractor pursuant to Sections (5) to (8), inclusive, of this Agreement and the Owner and Contractor shall hold Escrow Agent harmless from Escrow Agent's release and disbursement of the securities and interest as set forth above.

10. The names of the persons who are authorized to give written notice or to receive written notice on behalf of the Owner and on behalf of Contractor in connection with the foregoing, and exemplars of their respective signatures are as follows:

On behalf of Owner:

---

Title

---

Name

---

Signature

---

Address

On behalf of Contractor:

---

Title

---

Name

---

Signature

---

Address

On behalf of Agent:

---

Title



---

Name

---

Signature

---

Address

At the time the Escrow Account is opened, the Owner and Contractor shall deliver to the Escrow Agent a fully executed counterpart of this Agreement.

IN WITNESS WHEREOF, the parties have executed this Agreement by their proper officers on the date set forth above.

OWNER

CONTRACTOR

---

Title

---

Title

---

Name

---

Name

---

Signature

---

Signature

## **INSURANCE DOCUMENTS & ENDORSEMENTS**

The OCIP insurance documents and required endorsements must be provided to the Liberty Union High School District within five (5) calendar days after receipt of notification of award. If the apparent low bidder fails to provide the documents required below, the District may award the Contract to the next lowest responsible and responsive bidder or release all bidders, and the bidder's bid security will be forfeited. All insurance provided by the bidder shall fully comply with the requirements set forth in Article 11 of the General Conditions.

11. DISABLED VETERAN BUSINESS ENTERPRISE (DVBE) CONTRACTOR CLOSE-OUT STATEMENT

The Contractor shall complete this form, as a condition to Final Payment, for purposes of reporting participation by Disabled Veteran Business Enterprises (DVBE) in the Contract for the Project/Bid No. specified below.

Project Name: \_\_\_\_\_

Bid No.: \_\_\_\_\_

DSA No.: \_\_\_\_\_

Name	Address/Phone	Category of Work*	\$ Amount of Contract

\* Categories of work include: (1) construction services (specify services that DVBE will provide); (2) architecture and engineering services; (3) procurement of materials, supplies and equipment; and (4) information technology.

The undersigned, on behalf of the Contractor, certifies that DVBE participation on the Contract for Bid No. \_\_\_\_\_ equaled \_\_\_\_\_ dollars (\$\_\_\_\_\_ ), which represents approximately \_\_\_\_\_ percent (\_\_\_\_%) of the total Contract price including change orders for the Project.

Company: \_\_\_\_\_

Name: \_\_\_\_\_

Title: \_\_\_\_\_

Signature: \_\_\_\_\_

Date: \_\_\_\_\_

**CONTRACTOR CERTIFICATION REGARDING BACKGROUND CHECKS**

**(Modernization Projects)**

\_\_\_\_\_ certifies that it has performed one of the following:  
[Name of contractor/consultant]

Pursuant to Education Code section 45125.1, Contractor has conducted criminal background checks, through the California Department of Justice, of all employees providing services to the \_\_\_\_\_ District, pursuant to the contract/purchase order dated \_\_\_\_\_, and that none have been convicted of serious or violent felonies, as specified in Penal Code sections 1192.7(c) and 667.5(c), respectively.

As further required by Education Code section 45125.1, attached hereto as Attachment "A" is a list of the names of the employees of the undersigned who may come in contact with pupils.

OR

Pursuant to Education Code section 45125.2, Contractor will ensure the safety of pupils by one or more of the following methods:

1. The installation of a physical barrier at the worksite to limit contact with pupils.
2. Continual supervision and monitoring of all employees of the entity by an employee of the entity whom the Department of Justice has ascertained has not been convicted of a violent or serious felony.

I declare under penalty of perjury under the laws of the United States that the foregoing is true and correct.

Date \_\_\_\_\_, 20\_\_

\_\_\_\_\_  
[Name of Contractor/Consultant]

\_\_\_\_\_  
By its: \_\_\_\_\_

**ATTACHMENT A:**

**CONTRACTOR CERTIFICATION REGARDING BACKGROUND CHECKS**

*(INSERT NAMES OF EMPLOYEES WHO MAY COME IN CONTACT WITH PUPILS)*

## **GENERAL CONDITIONS**

### **ARTICLE 1 DEFINITIONS**

#### **1.1 BASIC DEFINITIONS**

NOTE: The following shall not be construed as a comprehensive list of all definitions in the Contract Documents and there may be other definitions set forth in the Contract Documents. Additionally, any references to any DSA forms, documents or requirements shall be construed to incorporate any updates, supplements, or additions. The Contractor shall be required to meet the latest DSA requirements applicable to the Project.

1.1.1 Action of the Governing Board is a vote of a majority of the District's Governing Board.

1.1.2 Approval means written authorization through action of the Governing Board. The Governing board has delegated to the Superintendent or Chief Business Officer the authority to approve certain modifications, Change Orders or Immediate Change Directives. In no case shall the Superintendent or Chief Business Officer have authority to approve total Change Orders or Modifications to the Project exceeding 10% of the Contract Sum.

1.1.3 Architect means the architect, engineer, or other design professional engaged by the District to design and perform general observation of the work of construction and interpret the Drawings and Specifications for the Project. (See ARTICLE 4)

1.1.4 As-Builts are a set of Plans and Specifications maintained by the Contractor clearly showing all changes, revisions, substitutions, field changes, final locations, and other significant features of the Project. The As-Builts shall be maintained continuously throughout the Work for the Project and is both a prerequisite to the issuance of Payment Application and a requirement for Contract Close-Out. (See Article 3.17)

1.1.5 Beneficial Occupancy is the point in time when a building or buildings are fit for occupancy is fit for occupancy and its intended use. Basic requirements are the building is safe, at or near Substantial Completion, and all fire/ life safety items are approved and operational. The fact that a building is occupied does not mean that the building is ready for Beneficial Occupancy if there are elements that are unsafe or if fire/ life safety items are not approved and operational. Taking occupancy on a structure that is under a fire watch is not considered beneficial occupancy. Further, taking of Beneficial Occupancy is not a point in time when retention is due unless the entire school has obtained a Certificate of Substantial Completion that meets the definition of 1.1.46.

1.1.6 Claims. A Claim is a request for payment, supported by back-up documentation which includes, invoices time sheets, or other documents substantiating legitimacy or entitlement that is submitted during the Project or immediately following the Project made prior to the Final Retention Payment Application and prior to Final Completion of the Project. A "Claim" means a separate demand by the Contractor for (1) time extension, (2) payment of money or damages arising from Work done by or on behalf of the Contractor pursuant to the CONTRACT and payment of which is not otherwise expressly provided for or the claimant is not otherwise entitled to, or (3) and amount the payment of which is disputed by the District. (See Article 4.6)

1.1.7 Change Order (CO). A CO is a written instrument prepared by the Architect and signed by the District (as authorized by the District's Governing Board), the Contractor, and the Architect, stating

## **GENERAL CONDITIONS**

their agreement upon (1) A description of a change in the Work, (2) The amount of the adjustment in the Contract Sum, if any; and (3) The extent of the adjustment in the Contract Time, if any. (See Article 7.2)

1.1.8 Change Order Request (COR). A COR is a written request supported by backup documentation prepared by the Contractor requesting that the District and the Architect issue a CO based upon a proposed change, or a change that results in an adjustment in cost, time or both, or arising from an RFP, CCD or ICD. (See Article 7.6)

1.1.9 Close-Out means the process for Final Completion of the Project, but also includes the requirements for the DSA Certification that the Project is Complete (See DSA Certification Guide). (See Article 9.9)

1.1.10 Construction Change Document (CCD). A Construction Change Document is a DSA term that is utilized to address changes to the DSA approved Plans and Specifications. There are two types of Construction Change Documents. (1) DSA approved CCD Category A for work affecting structural, access or fire/ life safety of the Project which will require a DSA approval; and, (2) CCD Category B for work NOT affecting structural safety, access compliance or fire/ life safety that will not require a DSA approval (except to confirm that no approval is required). Both CCD Category A and Category B shall be set forth in DSA Form 140 and submitted to DSA as required. (See Article 7.3)

1.1.11 Complete/ Completion/ Final Completion means that all Work in the Contract Documents is finished, the requirements of the Contract Documents have been met, the Project has been Closed Out, and all Work has ceased on the Project. This may also be referred to as Final Completion. In most cases, the recording of a Notice of Completion shall represent Completion of the Project. Beneficial Occupancy does not mean the Work is Complete.

1.1.12 Completion Date is the date when all Work for the Project shall be Substantially Complete and is the date assigned at the end of the Contract Time for the Project. (See Article 1.1.46)

1.1.13 Construction Manager. The Construction Manager is a consultant to the District contracted to assist in Project planning, management and construction of the Project. If there is a Construction Manager, they may assist in various aspects of the Project including, but not limited to Monitoring the progress of the construction, reviewing and monitoring the schedule, progress of work, monitoring pay requests, facilitating communications, advising the District and its Board of Education on various aspects of the construction process, monitoring the RFI, COR, CCD, ICD, RFP, Claims, Disputes and other Project related processes.

1.1.14 Contract or Agreement when the terms are used in these General Conditions shall be references to the Contract Documents as defined herein.

1.1.15 Contract Documents (sometimes referred to as Construction Documents) consist of the Agreement between District and Contractor (hereinafter the Agreement or Contract), Conditions of the Contract (General, Supplementary and other Conditions), Drawings, Specifications, Addenda issued prior to bid, instructions to bidders, notice to bidders, and the requirements contained in the Bid Documents, other documents listed in the Agreement, and Modifications issued after execution of the Contract. A Modification is a written amendment to the Contract signed by parties, a Change Order, a Construction Change Document, or a written order for a minor change in the Work issued by the Architect. The Contract Documents collectively form the Contract. The Contract represents the entire and integrated Agreement between the parties hereto and supersedes prior negotiations, representations, or agreements, either written or oral. The Contract may be amended or modified only by a written Modification. The Contract

## GENERAL CONDITIONS

Documents shall not be construed to create a contractual relationship of any kind between the Architect and Contractor, between the District and any Subcontractor or Sub-subcontractor, or between any persons or entities other than the District and the Contractor. The Architect shall, however, be entitled to performance and enforcement of obligations under the Contract intended to facilitate performance of the Architect's duties.

1.1.16 Contract Time is the time period specified in the Contract Documents in which the Project shall be completed. This is sometimes referred to a Contract Duration, or "time in which the Contractor has to complete the Project". (See Article 8.1.1)

1.1.17 Contractor, District, and Architect are those mentioned as such in the Agreement. They are treated throughout the Contract Documents as if they are of singular number and neuter gender. Any reference to "Owner" shall mean "District" or Liberty Union High School District.

1.1.18 Cure is the act of remedying a material failure to perform under the terms of the Contract Documents during the time provided to correct Contractor's Default. Specific time periods are provided to Cure and Correct a Contractor Default under Article 14 and for a Partial Default under Article 2.2 as well as elsewhere in the Contract Documents.

1.1.19 Days mean calendar days unless otherwise specifically stated.

1.1.20 Default is a material breach of Contract. A Termination for Cause under Article 14 is a declaration of Default of the Contract and shall act as a demand upon the Surety to perform under the terms of the Performance Bond. Partial Defaults may also be tendered to the Surety at District's discretion. (See Article 2.2)

1.1.21 Dispute. A dispute is a disagreement on terms or conditions of the Project where the Contractor's opinion of the Project, Payment, Change Order or Request for Proposal differs from that of the District or Architect. A dispute only rises to the level of a claim once the dispute is assembled with back-up documentation and presented for evaluation. (See Article 4.6)

1.1.22 District Representative is the person designated by the District to represent the District during the Construction for the Project. This District Representative shall have the delegated authority as further defined in Article 1.1.2. This District Representative may be an employee of the District who may have the delegated authority as set forth in Article 1.1.3, and may also include Construction Managers. In some cases, the District and its Board may be assisted by a Construction Manager. When a Construction Manager is assisting the District, the Contractor, Architect, and Inspector shall have a primary contact with the District's Construction Manager who will advise the District.

1.1.23 Drawings/Plans are graphic and pictorial portions of the Contract Documents prepared for the Project and approved changes thereto, wherever located and whenever issued, showing the design, location, and scope of the Work, generally including Plans, elevations, sections, details, schedules, and diagrams as drawn or approved by the Architect. Sometimes Drawings will also be included in Addenda, Change Orders, and Specifications.

1.1.24 DSA is the Division of State Architect. DSA is the agency that provides design and construction oversight for K-12 Schools, Community Colleges, and State Funded Charter School Projects. DSA is the responsible agency for this Project and Contractor has submitted a bid for the Project since Contractor is familiar with Contractor's responsibilities under the DSA requirements more thoroughly set forth at Title 24 of the California Code of Regulations. Contractor agrees to abide by the jurisdiction of



## GENERAL CONDITIONS

DSA and shall construct the Project to conform with the approved Plans, Specifications, Addenda, and Change Orders (inclusive of approved CCD's and ICD's issued by the District pending CCD approval). See DSA website.

1.1.25 Emergency shall be defined as a sudden, unexpected occurrence, involving a clear and imminent threat to the continuation of school classes, a critical path delay that will result in not being able to occupy the school when students arrive to use the facility, danger from the facility or from outside the facility, Act of God, or other action which requires immediate action to prevent or mitigate loss of, or damage to, life, health, property, or essential public services.

1.1.26 Float the total number of days an activity may be extended or delayed without delaying the Completion Date shown in the schedule. Float will fall into three categories: (1) Rain Days; (2) Governmental Delays; and, (3) Project Float. (See Article 8.1.4)

1.1.27 Immediate Change Directive. (ICD) A written order prepared by the Architect and signed by the District and the Architect, directing a change in the Work where the Work must proceed immediately and stating a proposed basis for adjustment, if any, in the Contract Sum or Contract Time, or both. (See Article 7.3)

1.1.28 Inspector of Record (IOR)/ Project Inspector (PI) is the individual retained by the District in accordance with Title 24 of the California Code of Regulations and who will be assigned to the Project

1.1.29 Notice of Non-Compliance (DSA Form 154) is a document issued by the Inspector if there is a deviation from the DSA approved Plans, Specifications, and Change Orders. (See Article 7.1.2)

1.1.30 Payment Application or Certificate of Payment is the Contractor's certified representation of the actual level of Work performed on the Project. Payment Applications are sometimes also called "Certificate of Payment", "Request for Payment", "Payment Application", or similar terms, and shall follow the Schedule of Values that are approved by the Architect, Inspector and District. (See Article 9.3)

1.1.31 Project is the complete construction of the Work performed in accordance with the Contract Documents.

1.1.32 Project Manual is the volume assembled for the Work which may include, without limitation, the bidding requirements, sample forms, Conditions of the Contract, and Specifications.

1.1.33 Provide shall include "provide complete in place," that is "furnish and install complete."

1.1.34 Punch List/ Punch Item/ Incomplete Punch Item is a list of minor repair items, prepared after the issuance of a Certificate of Substantial Completion, by the Inspector and Architect of Work required in order to complete the Contract Documents and ensure compliance with the DSA Approved Plans so the Project may be Closed Out. Issuance of the Retention Payment is dependent of the proper completion of the Punch List. (See Article 9.9)

1.1.34.1 *Contractor's List of Punch Items* is a list of minor repair items the Contractor submits when the Contractor considers the Work Substantially Complete. Submission of this List of Incomplete Punch Items is the Contractor's representation that the Project is Substantially Complete. (See Article 9.9.1.1)

## **GENERAL CONDITIONS**

1.1.35 Request for Information (RFI) is a written request prepared by the Contractor requesting the Architect to provide additional information necessary to clarify or amplify an item which the Contractor believes is not clearly shown or called for in the Drawings or Specifications, or to address problems which have arisen under field conditions. (See Article 7.4)

1.1.36 Request for Proposal (RFP) is a written request prepared by the Architect (and/or CM) requesting the Contractor to submit to an estimate of the effect of a proposed change on the Contract Price and (if applicable) the Contract Time. (See Article 7.5)

1.1.37 Safety Orders are those issued by any city, county, state or federal agency having jurisdiction over the Project.

1.1.38 Schedule is the Contractor's view of the practical way in which the Work will be accomplished. In this Agreement there is a requirement for a Baseline Schedule and regular Schedule Updates that show all Work to be completed during the Contract Time and shall include all items listed under Article 8.3.2.9. See Article 8 of the General Conditions.

1.1.39 Schedule of Values is a detailed breakdown of the Contract Price for each Project, building, Phase of Work or Site as determined by the District. This Schedule of Values shall adequately detail the price for the Work so Progress Payments Applications can be meaningfully reviewed by the Inspector, Architect of Record, Engineer of Record, and District. (See Article 9.2)

1.1.40 Separate Contracts are Contracts that the District may have with other Contractors, vendors, suppliers, or entities to perform Work on the Project. This may include, but is not limited to Multi-Prime Trade Contractors, furniture installers, testing agencies, clean-up contractors, or network or low voltage contractors. Contractor shall plan for certain other contractors that may also be working on the Project site and address these other contractors in Contractor's Schedule. (See Article 6)

1.1.41 Site refers to the grounds of the Project as defined in the Contract Documents and such adjacent lands as may be directly affected by the performance of the Work.

1.1.42 Specifications are that portion of the Contract Documents consisting of the written requirements for material, equipment, construction systems, instructions, quality assurance standards, workmanship, and performance of related services.

1.1.43 Standards, Rules, and Regulations referred to are recognized printed standards and shall be considered as one and a part of these Specifications within limits specified. Federal, state and local regulations are incorporated into the Contract Documents by reference.

1.1.44 Stop Work Order, or an Order to Comply, is issued when either (1) the Work proceeds without DSA approval; (2) the Work proceeds without a DSA Inspector of Record, or (3) where DSA determines that the Work is not being performed in accordance with applicable rules and regulations, and would compromise the structural integrity of the Project or would endanger lives. If a Stop Work Order is issued, the Work in the affected area shall cease until DSA withdraws the Stop Work Order. Pursuant to Education Code section 17307.5(b), the District shall not be held liable in any action filed against the District for any delays caused by compliance with the Stop Work Order

1.1.45 Subcontractor, as used herein, includes those having direct or indirect contracts with Contractor and ones who furnished labor, material or services for a special design according to Plans, Drawings, and Specifications of this Work.

## **GENERAL CONDITIONS**

1.1.46 Substantial Completion/ Substantially Complete(d) is not reached unless and until each of the following four (4) conditions have been met: (1) all contractually required items have been installed with the exception of only minor and Incomplete Punch List Items (See Article 9.9.1.2 ); (2) All Fire/Life Safety Systems have been installed, and are working and signed off on the DSA Form 152 Inspection Card, and all building systems including mechanical, electrical and plumbing are all functioning; (3) all other items DSA Form 152 Inspection Card for the Project have been approved and signed off; and (4) the Project is fit for occupancy and its intended use. For the purposes of this Contract, any references to Completion Date means Substantial Completion Date.

1.1.47 Substitution is a change in product, material, equipment, or method of construction from those required by the Construction Documents proposed by the Contractor. For this Project, a Substitution is subject to the filing of a Construction Substitution Request Form during the time of bid and meeting the requirements of Article 3.10.

1.1.48 Supplementary Conditions/ Supplementary General Conditions/ Special Conditions are terms that are sometimes used interchangeably and refer to any additional requirements or changes to the General Conditions as noted.

1.1.49 Surety is the person, firm, or corporation that executes as a bid bond, Payment Bond or Performance Bond guarantor on the Contractor's Bid, Contractor's Performance on the Contract and Payment of the Contractor's Subcontractors, material suppliers, vendors and labor on the Project. The Surety is bound to the same extent as the Contractor is bound once a Default occurs. A default includes a Termination for Substantial Failure to Perform under Article 14, but also includes any breach of Contract and is subject to the requirements and responsibilities as set forth in the Performance Bond.

1.1.50 Work shall include all labor, materials, services and equipment necessary for the Contractor to fulfill all of its obligations pursuant to the Contract Documents. It shall include the initial obligation of any Contractor or Subcontractor who performs any portion of the Work, to visit the Site of the proposed Work (a continuing obligation after the commencement of the Work), to fully acquaint and familiarize itself with the conditions as they exist and the character of the operations to be carried out under the Contract Documents, and make such investigation as it may see fit so that it shall fully understand the facilities, physical conditions, and restrictions attending the Work under the Contract Documents. Each such Contractor and its Subcontractors shall also thoroughly examine and become familiar with the Drawings, Specifications, and associated Contract Documents and bid documents before preparing and submitting any bid.

1.1.51 Workers include laborers, workers, and mechanics.

## 1.2 **EXECUTION, CORRELATION AND INTENT**

### 1.2.1 Correlation and Intent

1.2.1.1 *Documents Complementary and Inclusive.* The Contract Documents are complementary and are intended to include all items required for the proper execution and completion of the Work. All Contract Documents form the Contractor's Contract with the District. Any item of Work mentioned in the Specifications and not shown on the Drawings, or shown on the Drawings and not mentioned in the Specifications, shall be provided by Contractor as if shown or mentioned in both. The Contractor is bound to provide the Work complete and is under a legal duty to carefully study Plans and schedule operations well ahead of time and identify inconsistencies with the Plans and Specifications and

## GENERAL CONDITIONS

call such inconsistencies to the attention of the Architect or Registered Engineer through the Inspector under Section 4-343(b) of Title 24.

1.2.1.2 *Work to be Complete.* Contractor has thoroughly studied the Contract Documents and understands that the District contracted with Contractor to provide a complete Project which means complete systems and buildings. The entire set of Contract Documents shows a complete Project and Contractor agrees that there are multiple disciplines putting together a set of Contract Documents. Thus, if portions of a system are shown on some Drawings and not others, this does not mean the Contractor is to only provide part of a system. For example, if an air conditioning unit is shown on the mechanical Drawings, the plumbing for the air conditioning is shown on another Drawing, and the electrical shown on the electrical Drawings, the Contractor is to provide a complete and working air conditioning system. The only time when an item is supplied incomplete is if the system is shown specifically as incomplete since others will be completing the system. Work includes, but is not limited to materials, workmanship, and manufacture of fabrication of components for the Project.

1.2.1.3 *Coverage of the Drawings and Specifications.* The Drawings and Specifications generally describe the Work to be performed by Contractor. Generally, the Specifications describe Work which cannot be readily indicated on the Drawings and indicate types, qualities, and methods of installation of the various materials and equipment required for the Work. It is not intended to mention every item of Work in the Specifications, which can be adequately shown on the Drawings, or to show on the Drawings all items of Work described or required by the Specifications even if they are of such nature that they could have been shown. All materials or labor for Work, which is shown on either the Drawings or the Specifications (or is reasonably inferable therefrom as being necessary to complete the Work), shall be provided by the Contractor. The Contractor is responsible for the whole Project as contractually set forth as the Contract Documents. It is intended that the Work be of sound, quality construction, and the Contractor shall be responsible for the inclusion of adequate amounts to cover installation of all items indicated, described, or implied in the portion of the Work to be performed by them.

1.2.1.4 *Conflicts.* In the event there is a discrepancy between the various Contract Documents, it is intended that the more stringent, higher quality, and greater quantity of Work shall apply.

1.2.1.5 *Conformance with Laws.* Each and every provision of law required by law to be inserted in this Contract shall be deemed to be inserted herein, and the Contract shall be read and enforced as though it were included herein, even if through mistake or otherwise any such provision is not inserted, or is not correctly inserted.

Before commencing any portion of the Work, Contractor shall check and review the Drawings and Specifications for such portion for conformance and compliance with all laws, ordinances, codes, rules and regulations of all governmental authorities and public and municipal utilities affecting the construction and operation of the physical plant of the Project, all quasi-governmental and other regulations affecting the construction and operation of the physical plant of the Project, and other special requirements, if any, designated in the Contract Documents. Such checking shall include review of Title 24 of the California Code of Regulations, California Building Code, local utility, local water connection, local grading and all other applicable agencies. In the event Contractor observes any violation of any law, ordinance, code, rule or regulation, or inconsistency with the Contract Documents, Contractor shall, within five (5) days, notify the Inspector, Architect and District in writing of same and shall ensure that any such violation or inconsistency shall be corrected in the manner provided hereunder prior to the construction of that portion of the Project. (See Title 24 Section 4-343)

## **GENERAL CONDITIONS**

The Contractor shall bear all expenses of correcting Work done contrary to said laws, ordinances, rules, and regulations if the Contractor performed same (1) without first consulting the Architect for further instructions regarding said Work or (2) disregarded the Architect's instructions regarding said Work.

1.2.1.6 *Ambiguity and Inconsistency.* Before commencing any portion of the Work, Contractor shall carefully examine all Drawings and Specifications and other information given to Contractor as to materials and methods of construction and other Project requirements. Prior to commencing any portion of the Work, Contractor shall notify Architect and District in writing of any perceived or alleged error, inconsistency, conflict, ambiguity, or lack of detail or explanation in the Drawings and Specifications in the manner provided herein. If the Contractor or its Subcontractors, material or equipment suppliers, or any of their officers, agents, and employees performs, permits, or causes the performance of any Work under the Contract Documents, which it knows or should have known to be in error, inconsistent, or ambiguous, or not sufficiently detailed or explained, Contractor shall bear any and all costs arising therefrom including, without limitation, the cost of correction thereof without increase or adjustment to the Contract Price or the time for performance. Contractor shall maintain an adequate inspection system and perform personal observations and review work and pre-plan the project to ensure the Work performed under the Contract conforms to Contract requirements. Contractor shall maintain records of such review and observation to ensure strict compliance with the terms of the Contract.

1.2.1.7 *Typical Parts and Sections.* Whenever typical parts or sections of the Work are completely detailed on the Drawings, and other parts or sections which are of the same construction are shown in outline only, the complete or more detailed shall apply to the Work which is shown in outline.

1.2.1.8 *Dimensions.* Dimensions of Work shall not be determined by scale or rule. Figured dimensions shall be followed at all times. If figured dimensions are lacking on Drawings, Architect shall supply them on request. The Architect's decisions on matters relating to aesthetic effect will be final.

### 1.2.2 Bid Clarifications, Addenda and Deferred Approvals

1.2.2.1 *Bid Clarifications and Addenda* are the changes in Specifications, Drawings, Contract Documents, and Plans which have been authorized in writing by the District or Architect, and which alter, explain, or clarify the Contract Documents. Addenda shall govern over all other Contract Documents. Subsequent addenda issued shall govern over prior addenda unless otherwise specified in the addenda.

1.2.2.2 *Deferred Approvals.* Deferred Approvals are Submittals that are reviewed by the Architect (or Engineer of Record) and submitted to DSA for approval based on thorough detailing of manufacturer and Project specific design. See Article 3.9.1 and 3.9.3. The Deferred Approval item cannot be fully detailed on the originally approved Drawings or Specifications because of variations in product design and manufacture. Contract Documents which require Deferred Approval items are meant to be for illustration purposes only. Approval of Plans for such a portion of the Work may be deferred until the material suppliers and Subcontractors are selected. All Deferred Approvals are noted in the Plans and Specifications. Contractor is responsible for all Deferred Approval requirements set forth in the Contract Documents. Contractor is responsible to comply with all laws, building codes, Title 24 and regulations necessary to obtain all necessary approvals, including those required from the Division of the State Architect ("DSA") and the State Fire Marshall. Contractor shall not be granted an extension of time for failure to plan, schedule for and obtain necessary approvals. Contractor shall Schedule all Deferred Approval items in the Baseline Schedule and Schedule Updates under Article 3.9.6

## GENERAL CONDITIONS

### 1.2.3 Specification Interpretation

1.2.3.1 *Titles.* The Specifications are separated into titled sections for convenience only and not to dictate or determine the trade or craft involved.

1.2.3.2 *As Shown, Etc.* Where “as shown,” “as indicated,” “as detailed,” or words of similar import are used, reference is made to the Drawings accompanying the Specifications unless otherwise stated. Where “as directed,” “as required,” “as permitted,” “as authorized,” “as accepted,” “as selected,” or words of similar import are used, the direction, requirement, permission, authorization, approval, acceptance, or selection by Architect is intended unless otherwise stated.

1.2.3.3 *General Conditions.* The General Conditions and Supplementary General Conditions are a part of the Contract Documents which further defines and refines the Contract entered between the Contractor and District.

1.2.3.4 *Abbreviations.* In the interest of brevity, the Specifications are written in an abbreviated form and may not include complete sentences. Omission of words or phrases such as “Contractor shall,” “shall be,” etc., are intentional. Nevertheless, the requirements of the Specifications are mandatory. Omitted words or phrases shall be supplied by inference in the same manner as they are when a “note” occurs on the Drawings. In the interest of brevity, the Contract Documents frequently omit modifying words such as “all” and “any” and articles such as “the” and “an,” but the fact that a modifier or an article is absent from one statement and appears in another is not intended to affect the interpretation of either statement.

1.2.3.5 *Plural.* Words in the singular shall include the plural whenever applicable or the context so indicates.

1.2.3.6 *Metric.* The Specifications may indicate metric units of measurement as a supplement to U.S. customary units. When indicated thus: 1” (25 mm), the U. S. customary unit is specific, and the metric unit is nonspecific. When not shown with parentheses, the unit is specific. The metric units correspond to the “International System of Units” (SI) and generally follow ASTM E 380, “Standard for Metric Practice.”

1.2.3.7 *Standard Specifications.* Any reference to standard specifications of any society, institute, association, or governmental authority is a reference to the organization’s standard specifications, which are in effect at the date of the Contractor’s proposal unless directed otherwise. If applicable specifications are revised prior to completion of any part of the Work, the Contractor may, if acceptable to Architect, perform such Work in accordance with the revised specifications. The standard specifications, except as modified in the Specifications for the Project, shall have full force and effect as though printed in the Specifications. Architect will furnish, upon request, information as to how copies of the standard specifications referred to may be obtained.

### 1.2.4 Rules of Document Interpretation

1.2.4.1 In the event of conflict within the Drawings, the following rules shall apply:

- a. General Notes, when identified as such, shall be incorporated into other portions of Drawings.

## **GENERAL CONDITIONS**

- b. Schedules, when identified as such, are complementary with other notes and other portions of Drawings including those identified as General Notes.
- c. Larger scale Drawings shall take precedence over smaller scale Drawings.
- d. At no time shall the Contractor base construction on scaled Drawings.

1.2.4.2 Specifications shall govern as to materials, workmanship, and installation procedures.

1.2.4.3 If Contractor observes that Drawings and Specifications are in conflict, Contractor shall, prior to commencing work, notify the Architect in writing for the purposes of obtaining an interpretation of the Contract Documents.

1.2.4.4 In the case of conflict or inconsistencies, the order of precedence shall be as follows:

- a. General Conditions take precedence over Drawings and Specifications.
- b. Supplemental Conditions take precedence over General Conditions.
- c. The Agreement Form shall take precedence over the Supplemental Conditions.
- d. In the case of disagreement or conflict between or within Specifications, and Drawings, the more stringent, higher quality, and greater quantity of Work shall apply.
- e. Addenda shall take precedence over Drawings and Specifications.
- f. General Conditions shall take precedence over Addenda.
- g. Drawings and Specifications take precedence over the Soils Report.

### **1.3 OWNERSHIP AND USE OF ARCHITECT'S DRAWINGS, SPECIFICATIONS AND OTHER DOCUMENTS**

The Drawings, Specifications, and other Contract Documents for the Project are the property of the District and/or Architect pursuant Contract requirements between the District and Architect. The Contractor may retain one Contract record set. Neither the Contractor nor any Subcontractor, or material or equipment supplier shall own or claim a Copyright in the Drawings, Specifications, and other documents prepared by the Architect. All copies except the Contractor's record set, shall be returned or properly accounted for upon completion of the Work. The Drawings, Specifications, and other documents prepared by the Architect, and copies thereof furnished to the Contractor are not to be used by the Contractor or any Subcontractor, Sub-subcontractor, or material or equipment supplier on other projects or for additions to this Project outside the scope of the Work. The District and/or Architect hereby grants the Contractor, Subcontractors, Sub-subcontractors, and material or equipment suppliers a limited license to use applicable portions of the Drawings, Specifications, and other documents prepared for the Project in the execution of their Work under the Contract Documents. Submittal or distribution to meet official regulatory

## **GENERAL CONDITIONS**

requirements or for other purposes in connection with this Project is not to be construed as publication in derogation of the District's property interest or other reserved right.



## GENERAL CONDITIONS

### **ARTICLE 2 DISTRICT**

#### **2.1 INFORMATION AND SERVICES REQUIRED OF THE DISTRICT**

##### **2.1.1 Site Survey**

The District will furnish, at its expense, a legal description of the Site and a land survey showing the boundaries of the Site. Contractor shall be responsible for all surveys regarding location of construction, grading and site work.

##### **2.1.2 Soils**

When required by the scope of the Project, the District will furnish, at its expense, the services of geotechnical engineers or consultants when reasonably required and deemed necessary by the Architect or as required by local or state codes. Such services, with written reports and appropriate written professional recommendations, may include test boring, test pits, soil bearing values, percolation tests, air and water pollution tests, and ground corrosion and resistivity tests, including necessary operations for determining subsoil, air, and water conditions.

##### **2.1.3 Soils Report Part of the Contract Documents: Contractor Reliance**

A soils investigation report has been obtained from test holes at the Site, and such report is incorporated into this Contract and made available for the Contractor's use in preparing its bid and Work under this Contract. Where the Plans and Specifications are more specific and provide more significant structure, systems, reinforcing, thicknesses, or construction methods, the Drawings shall control over the soils report. The soils report is available at the Architect's office for review and it is Contractor's responsibility to ensure that Contractor has reviewed the soils investigation report. Any information obtained from such report or any other information given on Drawings as to subsurface soil condition or to elevations of existing grades or elevations of underlying rock is approximate only. If, during the course of Work under this Contract, Contractor encounters subsurface conditions which differ materially from those indicated in the soils report, then Contractor shall notify the District within five (5) calendar days of discovery of the condition, and changes to the Contract Price may be made in accordance with Article 7 entitled "Changes in the Work." Contractor agrees that no claim against District will be made by Contractor for damages and hereby waives any rights to damages in the event the Contractor fails to notify District within the five-day period mentioned above.

**WARNING: DISTRICT DOES NOT WARRANT THE SOILS AT THE PROJECT SITE. CONTRACTOR HAS REVIEWED AND IS FAMILIAR WITH THE REQUIREMENTS OF THE SOILS INVESTIGATION REPORT. CONTRACTOR UNDERSTANDS THAT PLANS, DRAWINGS AND SPECIFICATIONS SUPERSEDE THE SOILS REPORT IF THERE ARE CONFLICTS. FURTHER, IN ADDITION TO THE INFORMATION IN THE SOILS REPORT, CONTRACTOR HAS CONDUCTED AN INDEPENDENT INVESTIGATION OF THE PROJECT SITE AND THE SOILS CONDITIONS OF THE SITE. DISTRICT DOES NOT WARRANT THE SOILS CONDITIONS OF THE SITE AND CONTRACTOR IS FULLY RESPONSIBLE TO ASCERTAIN SITE CONDITIONS FOR THE PURPOSES OF DETERMINING CONSTRUCTION MEANS AND METHODS PRIOR TO COMMENCING CONSTRUCTION.**

## GENERAL CONDITIONS

### 2.1.4 Utilities

2.1.4.1 *Location of Point of Connection.* The locations shown for the point of connection are approximate. It shall be the responsibility of the Contractor to determine the exact location of all service connections.

2.1.4.2 *Regional Notification Center.* Contractor, except in an emergency, shall contact the appropriate regional notification center at least two (2) business days prior to commencing any excavation if the excavation will be conducted in an area or in a private easement which is known, or reasonably should be known, to contain subsurface installations other than the underground facilities owned or operated by the District, and obtain an inquiry identification number from that notification center. See Government Code section 4216.3. No excavation shall be commenced and carried out by the Contractor unless such an inquiry identification number has been assigned to the Contractor or any Subcontractor of the Contractor and the District has been given the identification number by the Contractor. Any damages arising from failure to make appropriate regional notification shall be at the sole risk of Contractor. Contractor shall solely be responsible for any fines, penalties or damages for violation of this Article and Government Code section 4216.6 or 4216.7. Any delays caused by failure to make appropriate regional notification shall be at the sole risk of Contractor and shall not be considered for extension of time pursuant to Article 8.4.

2.1.4.3 *Utilities - Removal and Restoration.* The District has endeavored to determine the existence of utilities at the Site of the Work from the records of the District of known utilities in the vicinity of the Work. The positions of these utilities as derived from such records are shown in the Contract Documents. Thus, the locations of the main or trunklines located on the Drawings are approximate locations and not exact.

No excavations were made to verify the locations shown for underground utilities. Other than the main or trunkline, which the District has endeavored to locate on the Plans, service connections or laterals to these utilities may not be shown on the Plans. It shall be the responsibility of the Contractor to determine the exact location of all service connections. The Contractor shall make its own investigations, including exploratory excavations, to determine the locations and type of service connections, prior to commencing work which could result in damage to such utilities. The Contractor shall immediately notify the District's representative as to any utility main or trunkline discovered by Contractor in a different position than provided by the Regional Notification Center. With respect to main or trunklines, Contractor is to immediately notify District if the location is substantially different than as shown in the Contract Documents.

Contractor shall coordinate its Work with all utilities, including, but not limited to electricity, water, gas and telephone and meet with said utilities prior to the start of any work. Contractor shall show timing of all utility coordination activities under the Scheduling requirements of Article 8.

2.1.4.4 *Other Utilities.* In case it should be necessary to remove, relocate, or temporarily maintain a utility because of interference with the Work, the work on the utility shall be performed and paid for as follows:

When it is necessary to remove, relocate or temporarily maintain a service connection, the cost of which is not required to be borne by the owner of the service connection, the Contractor shall bear all expenses incidental to the work on the service connection. The work on the service connection shall be done in a manner satisfactory to the owner thereof; it being understood that the owner

## GENERAL CONDITIONS

of the service connection has the option of doing such work with his own forces or permitting the work to be done by the Contractor.

When it is necessary to remove, relocate, or temporarily maintain a utility which is in the position shown on the Plans, the cost of which is not required to be borne by the owner thereof, the Contractor shall bear all expenses incidental to the work on the utility. The work on the utility shall be done in a manner satisfactory to the owner thereof; it being understood that the owner of the utility has the option of doing such work with his own forces or permitting the work to be done by the Contractor.

When it is necessary to remove, relocate, or temporarily maintain a utility which is not shown on the Plans or is in a position different from that shown on the Plans and were it in the position shown on the Plans would not need to be removed, relocated, or temporarily maintained, and the cost of which is not required to be borne by the owner thereof, the District will make arrangements with the owner of the utility for such work to be done at no cost to the Contractor, or will require the Contractor to do such work in accordance with Article 7 or will make changes in the alignment and grade of the Work to obviate the necessity to remove, relocate, or temporarily maintain the utility. Changes in alignment and grade will be ordered in accordance with Article 7 herein.

No representations are made that the obligations to move or temporarily maintain any utility and to pay the cost thereof is or is not required to be borne by the owner of such utility, and it shall be the responsibility of the Contractor to investigate to find out whether said cost is required to be borne by the owner of the utility.

The right is reserved to governmental agencies and to owners of utilities to enter at any time upon any street, alley, right-of-way, or easement for the purpose of making changes in their property made necessary by the Work and for the purpose of maintaining and making repairs to their property.

### 2.1.5 Existing Utility Lines; Removal, Relocation

2.1.5.1 *Main or Trunkline Facilities.* If the Contractor while performing the Contract discovers utility facilities not identified in the Contract Documents, Contractor shall notify the District and utility in writing prior to commencing work.

The owner of the public utility shall have the sole discretion to perform repairs or relocation work or permit the Contractor to do such repairs or relocation work at a reasonable price.

The Contractor shall exercise reasonable care and shall be compensated by the District for the actual verified field costs of locating, and removing, relocating, protecting or temporarily maintaining such main or trunkline utility facilities located in a substantially different location than in the Plans and Specifications, and for equipment in use on the project necessarily idled during such work. This Work shall be performed in accordance with Article 7 of these General Conditions.

2.1.5.2 *Assessment.* Nothing in these subparagraphs shall be deemed to require the District to indicate the presence of existing service laterals or appurtenances whenever the presence of such utilities on the Site can be inferred from the presence of other visible facilities, such as buildings, or meter junction boxes on or adjacent to the Site and could be inferred from the Main or Trunkline shown on the Drawings.

## **GENERAL CONDITIONS**

2.1.5.3 *Notification.* If the Contractor, while performing Work under this Contract, discovers utility facilities not identified by the District in the Contract Documents. Contractor shall, within five (5) days, notify the District and the utility in writing. If Contractor fails to notify the District within forty eight hours after discovery of any utility facilities not identified by District in the Contract Documents, Contractor waives all rights to be compensated for any extra Work or damages resulting from such discovered utilities.

### 2.1.6 Easements

District shall secure and pay for easements for permanent structures or permanent changes in existing facilities, if any, unless otherwise specified in the Contract Documents.

## 2.2 **DISTRICT'S RIGHT TO CARRY OUT THE WORK DUE TO PARTIAL DEFAULT IN A SPECIFIC SEGREGATED AREA OF WORK (48 HOUR NOTICE TO CURE AND CORRECT)**

If the Contractor Defaults or neglects to carry out the Work in accordance with the Contract Documents, the District may provide forty-eight (48) hour written notice to cure (a shorter period of time in the case of Emergency or a critical path delay as defined in Article 2.2.1) Contractor's Partial Default in a specific segregated area of work. The District's right to issue a Partial Default of the Contractor's Work and take over that segregated area of Work includes, but is not limited to:

1. Failure to supply adequate workers on the entire Project or any part thereof;
2. Failure to supply a sufficient quantity of materials;
3. Failure to perform any provision of this Contract;
4. Failure to comply with safety requirements, or due to Contractor is creation of an unsafe condition;
5. Cases of bona fide emergency;
6. Failure to order materials in a timely manner;
7. Failure to prepare Deferred Approval items or Shop Drawings in a timely manner;
8. Failure to comply with Contractor's Baseline or Update Schedule, meet critical Milestones which would result in a delay to the critical path, or delay the Contract Time;
9. Failure to comply with the Subletting and Subcontracting Fair Practices, Public Contract Code section 4100, et seq.
10. Failure to meet the requirements of the Americans with Disabilities Act;
11. Failure to complete Punch List work;
12. Failure to proceed on an Immediate Change Directive
13. Failure to correct a Notice of Deviation

## **GENERAL CONDITIONS**

If during the forty eight (48) hour period, the Contractor fails to Cure and correct the deficiency noted in the 48 hour notice of Partial Default with diligence and promptness, the District may correct such deficiencies without prejudice to other remedies the District may have, including a Termination for Cause as set forth in Article 14. If there are inadequate funds remaining the Project balance or in the Retention Escrow to address at least 150% of the costs set forth in the Article 2.2 notice, the District may copy the Surety on the written notice of Partial Default. If a notice to the Surety is provided, except in the cases of emergency or critical path delay, the Surety has the option to take over and complete the Work described in the written notice if Surety personally delivers notice to District that it intends to perform such work. In the case where written notice has been provided, the District shall allow Surety seven (7) days to perform the Work.

### 2.2.1 Service of Notice of Partial Default with Right to Cure

A written notice of Partial Default and right to cure under Article 2.2 (“Article 2.2 Notice” or “Notice of Partial Default”) shall be served by e-mail (with a copy provided by regular mail) to the e-mail address provided on the Bid submitted and copied to the Project Superintendent.

### 2.2.2 Shortened Time for Partial Default in the Case of Emergencies.

In an Emergency situation, the District may correct any of the deficiencies described in Article 2.2 without prejudice to other remedies by providing service of written notice of Emergency requiring a shortened time for Partial Default specifying the time given to cure, if any.

### 2.2.3 Shortened Time for Partial Default in the Case of Critical Path Delay

In the case of critical path delay, the District may correct any of the deficiencies described in Article 2.2 without prejudice to other remedies providing service of written notice of critical path delay to the Contractor with a specific description of the critical path delay items noting the line item or area of Work that is on the critical path and prescribe the length of shortened time to cure, if any.

### 2.2.4 Written Notice of Partial Default to be Deducted by Deductive Change Order

The District shall have the right to determine the reasonable value of the Article 2.2 Partial Default Work, or if there is an actual value for the Work, shall use that value and issue a Deductive Change Orders under Article 7.7.4

## GENERAL CONDITIONS

### **ARTICLE 3 THE CONTRACTOR**

#### 3.1 SUPERVISION AND CONSTRUCTION PROCEDURES

##### 3.1.1 Contractor

The Contractor shall continually supervise and direct the Work using the Contractor's best skill and attention. The Contractor shall be solely responsible for and have control over construction means, methods, techniques, sequences, procedures; and shall coordinate all portions of the Work under the Contract, unless the Contract Documents give other specific instructions concerning these matters. The Contractor shall not perform the Work without utilizing the Contract Documents or, where required, approved Submittals, Shop Drawings, or samples for any such portion of the Work. If any of the Work is performed by contractors retained directly by the District, Contractor shall be responsible for the coordination and sequencing of the work of those other contractors so as to avoid any impact on the Project Schedule pursuant to the requirements of Article 6 and Article 8. Specific duties of the Contractor shall include those set out in Section 43 of Title 21 of the California Code of Regulations and Section 4-343 of Title 24 of the California Code of Regulations. These duties include, but are not limited to the following:

3.1.1.1 *Responsibilities.* It is the duty of the Contractor to complete the Work covered by his or her Contract in accordance with the approved Plans and Specifications. The Contractor in no way is relieved of any responsibility by the activities of the Architect, Engineer, Inspector or DSA in the performance of their duties.

3.1.1.2 *Performance of the Work.* The Contractor shall carefully study the approved Plans and Specifications and shall plan its schedule of operations well ahead of time. If at any time it is discovered that work is being done which is not in accordance with the approved Plans and Specifications, the Contractor shall correct the Work immediately.

##### 3.1.2 Contractor Responsibility to Study the Plans and Specifications

All inconsistencies or timing or sequences which appear to be in error in the Plans and Specifications shall promptly be called to the attention of the Architect or, Engineer, for interpretation or correction. Local conditions which may affect the structure shall be brought to the Architect's attention at once. In no case, shall the instruction of the Architect be construed to cause work to be done which is not in conformity with the approved Plans, Specifications, change orders, construction change documents, and as required by law. (See Title 24, Section 4-343)

##### 3.1.3 All Work Under the Direction of Inspector

Pursuant to Title 24 requirements, the Contractor shall not carry on Work except with the knowledge of the Inspector. (See Title 24 generally)

##### 3.1.4 Contractor to Establish Timing and Protocol with Inspector

Contractor shall establish a protocol for requesting inspection with Inspector so as to not delay the Work and provide adequate time for the Inspector to perform inspection. If such a protocol is not established ahead of time, Inspector may utilize the time criteria set by Title 24 of 48 hours in advance of submitting form DSA 156 for each new area. DSA requirements under PR 13-01 specifically gives the

## **GENERAL CONDITIONS**

Special Inspector fourteen (14) days to post to the DSA website. Contractor is responsible for delays and for failure to plan.

For some Projects, there may be a need to incrementally install certain assemblies. It is up to Contractor to identify areas and assemblies that may be constructed incrementally. Contractor must identify and establish incremental areas of construction and establish protocols with Inspector for DSA 152 approvals so they may be presented to DSA. (See PR-13 item 1.17 for further discussion)

### **3.1.5 Verified Reports**

The Contractor shall make and submit to the office from time to time, verified reports as required in Title 24 Section 4-366. As part of the Close-Out of the Project (see Article 9.9), Contractor shall be required to execute a Form 6-C as required under Title 24 Sections 4-343.

Contractor shall fully comply with any and all reporting requirements of Education Code sections 17315, et seq., in the manner prescribed by Title 24, as applicable.

### **3.1.6 Contractor Responsibility**

The Contractor shall be responsible to the District for acts and omissions of the Contractor's employees, Subcontractors, material and equipment suppliers, and their agents, employees, invitees, and other persons performing portions of the Work under direct or indirect contract with the Contractor or any of its Subcontractors.

### **3.1.7 Obligations not Changed by Architect's Actions**

The Contractor shall not be relieved of obligations to perform the Work in accordance with the Contract Documents either by activities or duties of the Architect in the Architect's administration of the Contract or by tests, inspections, or approvals required or performed by persons other than the Contractor.

### **3.1.8 Acceptance/Approval of Work**

The Contractor shall be responsible to determine when any completed portions of the Work already performed under this Contract or provided pursuant to Article 6 are suitable to receive subsequent Work thereon.

## **3.2 SUPERVISION**

### **3.2.1 Full Time Supervision**

Unless personally present on the Project site where the Work is being performed, the Contractor shall keep on the Work at all times during its progress a competent, English speaking construction Superintendent satisfactory to the District. The Superintendent shall be present on a full-time basis, shall be dedicated exclusively to the Project and shall not share superintendency duties with another project or job. The Superintendent shall not be replaced except with written consent of the District. The Superintendent shall represent the Contractor in its absence and shall be fully authorized to receive and fulfill any instruction from the Architect, the Inspector, the District or any other District Representative (including CM in the cases where the District has a CM representative). All Requests for Information shall be originated by the Superintendent and responses thereto shall be given to the Superintendent. No Work

## **GENERAL CONDITIONS**

shall begin on any day by any Subcontractor or other person on the Project site until the Superintendent has arrived, or shall any Work continue during the day after the Superintendent has departed from the Project site. The Superintendent shall have authority to bind Contractor through the Superintendent's acts. The Superintendent shall represent the Contractor, and communications given to the Superintendent shall be binding on the Contractor. Before commencing the Work, Contractor shall give written notice to District (and CM representative) and Architect of the name and a Statement of Qualifications of such superintendent. Superintendent shall not be changed except with written consent of District, unless a superintendent proves to be unsatisfactory to Contractor and ceases to be in its employ, in which case, Contractor shall notify District and Architect in writing. Contractor shall provide a replacement superintendent approved by the District prior to performing additional work.

### 3.2.2 Staff

Notwithstanding other requirements of the Contract Documents, the Contractor and each Subcontractor shall: (1) furnish a competent and adequate staff as necessary for the proper administration, coordination, supervision, and superintendence of its portion of the Work; (2) organize the procurement of all materials and equipment so that the materials and equipment will be available at the time they are needed for the Work; and (3) keep an adequate force of skilled and fit workers on the job to complete the Work in accordance with all requirements of the Contract Documents.

### 3.2.3 Right to Remove

District shall have the right, but not the obligation, to require the removal from the Project of any superintendent, staff member, agent, or employee of any Contractor, Subcontractor, material or equipment supplier.

## 3.3 **LABOR AND MATERIALS**

### 3.3.1 Contractor to Provide

Unless otherwise provided in the Contract Documents, the Contractor shall provide and pay for labor, material, equipment, tools, construction equipment and machinery, water, heat, air conditioning, utilities, transportation, and other facilities, services and permits necessary for proper execution and completion of the Work whether temporary or permanent and whether or not incorporated or to be incorporated in the Work.

### 3.3.2 Quality

Unless otherwise specified, all materials and equipment to be permanently installed in the Project shall be new and shall be of the highest quality or as specifically stated in the Contract Documents. The Contractor shall, if requested, furnish satisfactory evidence as to kind and quality of all materials and equipment within ten (10) days of a written request by the District, including furnishing the District with bona fide copies of invoices for materials or services provided on the Project. All labor shall be performed by workers skilled in their respective trades, and shall be of the same or higher quality as with the standards of other school construction.

### 3.3.3 Replacement



## GENERAL CONDITIONS

Any work, materials, or equipment, which do not conform to these requirements or the standards set forth in the Contract Documents, may be disapproved by the District, in which case, they shall be removed and replaced by the Contractor at no additional cost or extension of time to the District.

### 3.3.4 Discipline

The Contractor shall enforce strict discipline and good order among the Contractor's and Subcontractor's employees, and other persons carrying out the Contract. The Contractor shall not permit employment of unfit persons or persons not skilled in tasks assigned to them. As used in this subsection, "unfit" includes any person who the District concludes is improperly skilled for the task assigned to that person, who fails to comply with the requirements of this article, or who creates safety hazards which jeopardize other persons and/or property.

### 3.3.5 Fingerprinting (Applicable at the time Project is Occupied and on all Projects where Workers will come in Contact with Pupils, such as Modernization Projects)

If applicable, Contractor shall comply with the applicable provisions of Education Code section 45125.1 in a method as determined by the District. Pursuant to Education Code section 45125.1, Contractor shall either conduct criminal background checks of all employees of Contractor assigned to the Project site, and shall certify that no employees who have been convicted of serious or violent felonies, as specified in Education Code section 45125.1, will have contact with pupils, by utilizing the Certification Regarding Background Checks and the corresponding Attachment "A" as found in the Contract Documents or shall be separated by a physical barrier from students.

If it is determined that Contractor must provide certification of employees, as part of such certification, Contractor must provide the District with a list of all employees providing services pursuant to this Agreement, and designate which sites such employees will be assigned. In performing the services set forth in this Agreement, Contractor shall not utilize any employees who are not included on the above-referenced list.

At District's sole discretion, District may make a finding, as authorized under Education Code section 45125.1, that Contractor's employees will have only "limited contact" with pupils. Contractor's failure to comply with this law shall be considered a material breach of this Agreement upon where this Agreement may be terminated, at District's sole discretion, without any further compensation to Contractor.

In the case of new construction Projects where there are no students, if the Project Schedule provides for Beneficial Occupancy or portions of the Project or if the Project should be delayed, then Contractor, at no additional costs, shall meet the requirements of either fingerprinting or providing a physical barrier as required by the District.

### 3.3.6 Noise, Drugs, Tobacco, and Alcohol

Contractor shall take all steps necessary to insure that employees of Contractor or any of its Subcontractors' employees do not use, consume, or work under the influence of any alcohol, tobacco or illegal drugs while on the Project. Contractor shall further prevent any of its employees or its Subcontractor employees from playing any recorded music devices or radios or wearing any radio headphone devices for entertainment while working on the Project. Likewise, Contractor shall prevent its employees or Subcontractor's employees from bringing any animal onto the Project. Contractors shall not violate any written school policies.

## **GENERAL CONDITIONS**

### **3.3.7 Delivery of Material**

Contractor shall place orders for materials or equipment so that the Work may be completed in accordance with the Construction schedule for the Work as set forth in Article 8 of this Agreement. Contractor shall, upon demand from the Architect, furnish to the Architect documentary evidence including, but not limited to purchase orders, invoices, bills of materials, work orders and bills of lading, showing that orders have been placed. Contractor shall have a system to receive materials and to ensure that the proper materials are being delivered, including in the case of critical materials to the Project, checking the delivery against Shop Drawings and ensuring that the materials meet the requirements of not only the Plans and Specifications, but also the approved Shop Drawings and Submittals and in conformance with Contractor's plan for delivery of materials (including but not limited to Contractor's representations in the Schedules for the Project and Contractor's equipment and materials schedule under Article 3.7.2.2). Contractor shall be responsible for all costs of accepting non-conforming materials delivered to the Project given Contractor's responsibilities and system for acceptance of deliveries. Contractor shall notify Inspector and District Representative (including CM) as early as possible, in writing, of the delivery of materials for the Project. The deliveries shall include documentation identifying the shipment sufficiently so that the Inspector, Architect or District Representative (including CM) may review the materials that are received. Under no circumstances shall materials be delivered to the Project site that are meant for another Project.

### **3.3.8 Liens and Other Security Interests of Subcontractors and Material Suppliers**

No material, supplies, or equipment for the Work shall be purchased subject to any chattel mortgage or under a conditional sale or other agreement by which an interest therein or in any part thereof is retained by seller or supplier. Contractor warrants good title to all material, supplies, and equipment installed or incorporated in Work and agrees upon completion of all Work to deliver premises, together with all improvements and appurtenances constructed or placed thereon by it, to District free from any claims, security interests, liens, or charges. Contractor further agrees that neither it nor any person, firm, or corporation furnishing any materials or labor for any Work covered by this Contract shall have any right to place a lien upon the premises or any improvement or appurtenance thereof, except that Contractor may install metering devices or other equipment of a utility company or political subdivision, title to which is commonly retained by the utility company or political subdivision. In event of installation of any such metering device or equipment, Contractor shall advise District as to its owner within five (5) days of such installation in writing, prior to making the installation.

Contractor agrees to indemnify, defend and hold the District harmless from any liens, stop notices, or assertion of security interests, including judgments and levies. If after written notice Contractor fails to address the lien, stop notice, or other security interest, the District may proceed to address the lien, stop notice or claim and seek reimbursement from Contractor.

### **3.3.9 Title to Materials**

The title to new materials or equipment for the Work of this Contract shall remain with Contractor until incorporated in the Work of this Contract until final acceptance of the Project; no part of said materials shall be removed from its place of storage, and Contractor shall keep an accurate inventory of all said materials and equipment in a manner satisfactory to the District or its authorized representative. Responsibility for materials remains with Contractor and Contractor shall replace materials in case of loss. District similarly may pay for materials stored off site, but Contractor shall remain responsible for the materials that are stored off site.

## **GENERAL CONDITIONS**

### 3.3.10 Assemblies

For all material and equipment specified or indicated in the Drawings, the Contractor shall provide all labor, materials, equipment, and services necessary, (including engineering as specifically required with Shop Drawings or Deferred Approvals) for complete assemblies and complete working systems. Incidental items not indicated on the Drawings, nor mentioned in the Specifications, that can legitimately and reasonably be inferred to belong to the Work described, or be necessary in good practice to provide a complete assembly or system, shall be furnished as though itemized in the Contract Documents in every detail. In all instances, material and equipment shall be installed in strict accordance with each manufacturer's most recent published recommendations and Specifications.

### 3.3.11 Noise Control

The Contractor shall be responsible for the installation of noise reducing devices on construction equipment. Contractor shall comply with the requirements of the city and county having jurisdiction with regard to noise ordinances governing construction sites and activities. Construction equipment noise is subject to the control of the Environmental Protection Agency's Noise Control Program (Part 204 of Title 40, Code of Federal Regulations). If school is in session at any point during the progress of the Project, and, in the District's reasonable discretion, the noise from such Work disrupts or disturbs the students or faculty or the normal operation of the school, at the District's request, the Contractor shall schedule the performance of all such Work around normal school hours or make other arrangements so that the Work does not cause such disruption or disturbance. There are specific periods of testing at operational schools and it is critical that Contractor control noise during periods of testing. In no event shall Contractor have a right to receive additional compensation or an extension to the Contract time as a result of any such rescheduling or the making of such arrangements. These controls shall be implemented during site preparation and construction. All noise related issues, including school operations, and noise during testing should be detailed in the Schedule provided pursuant to Article 8

## 3.4 **WARRANTY**

The Contractor warrants to the District and Architect that material and equipment furnished under the Contract will be of the highest quality and new unless otherwise required or permitted by the Contract Documents, that the Work will be free from defects not inherent in the quality required or permitted, and that the Work will conform with the requirements of the Contract Documents. Work not conforming to these requirements, including substitutions not properly approved and authorized, may be considered defective. Contractor's warranty to District includes, but is not limited to, the following representations:

3.4.1 In addition to any other warranties provided elsewhere, Contractor shall, and hereby does, warrant all Work after the date of Notice of Completion of Work by District and shall repair or replace any or all such Work, together with any other Work, which may be displaced in so doing that may prove defective in workmanship or materials within a one (1) year period from date of Final Completion which shall be no later than the final date of Punch List as noted at Article 9.11) without expense whatsoever to District, ordinary wear and tear, unusual abuse or neglect excepted. District will give notice of observed defects with reasonable promptness. Contractor shall notify District upon completion of repairs.

3.4.2 In the event of failure of Contractor to comply with above mentioned conditions within one week after being notified in writing, District is hereby authorized to proceed to have defects repaired and made good at expense of Contractor who hereby agrees to pay costs and charges therefore immediately on demand.

## **GENERAL CONDITIONS**

3.4.3 If, in the opinion of the District, defective Work creates a dangerous condition or requires immediate correction or attention to prevent further loss to the District, the District will attempt to give the notice required by this Article. If the Contractor cannot be contacted or does not comply with the District's requirements for correction within a reasonable time as determined by the District, the District may, notwithstanding the provisions of this article, proceed to make such correction or attention which shall be charged against Contractor. Such action by the District will not relieve the Contractor of the guarantee provided in this Article or elsewhere in this Contract.

3.4.4 This Article does not in any way limit the guarantee on any items for which a longer warranty is specified or on any items for which a manufacturer gives a guarantee for a longer period. Contractor shall furnish District all appropriate guarantee or warranty certificates upon completion of the project.

### **TAXES**

Contractor will pay all applicable Federal, State, and local taxes on all materials, labor, or services furnished by it, and all taxes arising out of its operations under the Contract Documents. District is exempt from Federal Excise Tax, and a Certificate of Exemption shall be provided upon request.

### **PERMITS, FEES AND NOTICES**

#### **Payment**

The Contractor shall secure and pay for all permits and governmental fees, licenses, and inspections necessary for proper execution and completion of the Work which are necessary after execution of the Contract and are legally required by any authority having jurisdiction over the Project, except those required by the Division of the State Architect (DSA). District shall be responsible for all testing and inspection as required by the DSA on-site or within the distance limitations set forth in Article 13.5.2, unless a different mileage range is specified in the Supplemental Conditions.

3.6.1.1 *DSA Fees.* DSA policy is to charge CCD review fees for processing and approval of changes in the Plans and Specifications through the Construction Change Document process. Contractor is specifically directed to the current DSA IR A-30 which provides fee structure and charges that will be incurred for proceeding with respect to the CCD process, a process that must be followed for each change in the Plans and Specifications.

#### **Compliance**

The Contractor shall comply with and give notices required by any law, ordinance, rule, regulation, and lawful order of public authorities bearing on performance of the Work. Specifically, the Division of State Architect provides State oversight of the Project and enforcement of Title 24 rules and regulations. Contractor is directed to the DSA website. There will be local governmental oversight from City, County or both. Finally, Regional Water Quality Control Board, State Fire Marshall, local fire marshal, Department of Industrial Relations, Department of Labor Standards Enforcement, and Air Quality Management District (Local and State) are some of the agencies that provide oversight and may require specific permits, fees, or provide oversight over the Project. Contractor represents understanding and specialized knowledge of the rules governing school districts and Contractor shall maintain compliance over the applicable rules and will file all documents required in order to ensure compliance with State, local, and other rules that apply to the Project.

## **GENERAL CONDITIONS**

### 3.6.3 Responsibility

The Contractor shall perform all Work in conformance with every law, statute, ordinance, building code, rule or regulation. The Contractor shall assume full responsibility for such Work and shall bear the attributable cost of correction or project delay.

Pursuant to Title 24 Section 4-343(b):

“Contractor shall carefully study the approved Plans and Specifications and shall plan a schedule of operations well ahead of time.... All inconsistencies or items which appear to be in error in the Plans and Specifications shall be promptly called to the attention of the architect or registered engineer, through the inspector, for interpretation or correction.”

To help Contractor plan its operations, Contractor is directed to study the current version of the DSA 152 Inspection Card Manual identifying the exact steps the Inspector is to follow in the review and sign off process for the DSA 152. The DSA 152 Inspection Card Manual provides specific detail as to the order of operations, review items and compliance items beyond the Specifications and Plans which are reviewed for DSA compliance. The most current version of this manual is located on DSA’s website.

Contractor is also specifically directed to the time periods for posting of Special Inspection Reports and Inspector Notifications under DSA PR 13-01 since the timing of Inspection is not a Governmental Entity related delay.

### 3.7 **SUBMITTALS REQUIRED AT THE COMMENCEMENT OF THE PROJECT**

#### 3.7.1 Requirements Within Ten (10) Calendar Days

Within ten (10) calendar days after Notice to Proceed, Contract shall submit the following:

- 3.7.1.1 Detailed Schedule of Values (See Article 9.2)
- 3.7.1.2 Submittal Listing and Schedule for Submittals
- 3.7.1.3 Critical Path Baseline Schedule (See Article 8)

#### 3.7.2 Requirements Within Thirty-Five (35) Calendar Days

Within thirty-five (35) calendar days after Notice to Proceed, Contractor shall submit the following:

3.7.2.1 *All Submittals for the Project* except those specifically agreed upon by District and Architect, in writing, and shall be specifically incorporated into the Submittal section of the Schedule so as to not delay the Work. The agreement to allow a later Submittal does not mean that Article 3.3.7 is waived. Contractor shall order materials and ensure prices are honored and secured for the Project.

- a. Structural Steel may be included as a later Submittal than 35 days if Structural Steel is a significant portion of the Work, at least one or some of the Project is a structural steel structural system, or as specifically agreed upon by the Architect or District.

## **GENERAL CONDITIONS**

- b. It is specifically agreed that submissions of structural steel Submittals shall not be piecemeal (unless some portion is requested separately by the District or Architect), shall provide complete designs, shall be stamped by the structural steel Subcontractor, Contractor, and structural steel Subcontractor's structural engineer at time of submission and as further addressed in Article 3.9.
- c. In no case shall the submission of structural steel Drawings delay the critical path for the schedule. If a Milestone is provided for submission of complete structural steel Shop Drawings then the date shall be no later than as set forth in the Milestone

3.7.2.2 *Exceptions to Submittal Within Thirty-Five (35) Days by Written Agreement.* A written request detailing the specific reasons for a submission later than 35 days due to complexity of design or non-critical path status of the Submittal shall be submitted at the time the Baseline Schedule is submitted. The Baseline Schedule shall not include a delayed Submittal until written agreement is provided. In addition to the request for providing a Submittal after the thirty-five (35) day period, a copy of the Contract with the Subcontractor who shall be performing the Submittal, a written statement from the Subcontractor verifying that work has commenced on the Submittal and providing Subcontractor's own schedule of Milestones and completion dates, and a corresponding Submittal designation in the Schedule as required under Article 8. Approval of a delayed Submittal shall not result in any increase in the Contract Price or result in an extension of time for the completion of the Project.

3.7.2.3 *Piecemeal Submissions of Submittals.* Piecemeal Submittals mean providing portions of Shop Drawings or Submittals as they are being completed. The submission of piecemeal Submittals results in the appearance of a submission when there is inadequate information for the Architect or Engineer to adequately review a submission. Piecemeal differs from submission of complete buildings or phases of buildings or complete assemblies. The Architect may agree to allow submission of single buildings or areas as long as the Submittals are complete.

### **3.8 DOCUMENTS, SAMPLES, AND COMPUTER AT THE SITE**

The Contractor shall maintain at the Site for the District one current copy of the California Building Code, Titles 19 and 24 of the California Code of Regulations, any other document required by DSA, and one record copy of the Drawings, Specifications, Addenda, Change Orders, and other Modifications, in good order and marked currently to record changes and selections made during construction. In addition, the Contractor shall maintain at the Site approved Shop Drawings, Product Data, Samples, and similar required Submittals. These documents shall be available to the Architect and shall be delivered to the Architect for delivery to the District upon completion of the Work.

Contractor shall have an operational computer with internet access so Contractor can review and post documents as required for the Project, including but not limited to the filing and posting of DSA required documents for the Project.

Contractor shall be prepared to review documents posted to the DSA Project website.

### **3.9 SUBMITTALS INCLUDING SHOP DRAWINGS, PRODUCT DATA, AND SAMPLES**

#### **3.9.1 Definitions**

## GENERAL CONDITIONS

3.9.1.1 *Deferred Approvals.* Approval of certain aspects of the construction may be deferred until the construction Contract has been awarded. To facilitate the design process, DSA grants Deferred Approval to the design and detailing of certain elements of the Project at the request of the Architect or Engineer of Record. Design elements that may be deferred may include, but are not limited to access floors, bleachers, elevator guide rails and related elevator systems, exterior wall systems - precast concrete, glass fiber reinforced concrete, etc., skylights, window wall systems, storefronts, stage rigging, and other systems as noted in the Contract Documents. (Also see Article 1.2.2.2 and 3.9.3)

3.9.1.2 *Shop Drawings.* The term “Shop Drawings” as used herein means Drawings, diagrams, equipment or product schedules, and other data, which are prepared by Contractor, Subcontractors, manufacturers, suppliers, or distributors illustrating some portion of the Work, and includes: illustrations; fabrication, erection, layout and setting Drawings; manufacturer’s standard Drawings; schedules; descriptive literature, instructions, catalogs, and brochures; performance and test data including charts; wiring and control diagrams; and all other Drawings and descriptive data pertaining to materials, equipment, piping, duct and conduit systems, and methods of construction as may be required to show that the materials, equipment, or systems and their position conform to the requirements of the Contract Documents.

3.9.1.3 *Manufactured* applies to standard units usually mass-produced, and “Fabricated” means items specifically assembled or made out of selected materials to meet individual design requirements. Shop Drawings shall: establish the actual detail of all manufactured or Fabricated items, indicate proper relation to adjoining work, amplify design details of mechanical and electrical systems and equipment in proper relation to physical spaces in the structure, and incorporate minor changes of design or construction to suit actual conditions.

3.9.1.4 *Submittals* is a term used interchangeably and sometimes refers to Shop Drawings, Product Data, and samples since all Subcontractor submissions are tracked in a Submittal Log and may include any of the noted items. However, generally, a Submittal is a manufacturer’s product information and Product Data including description, characteristics, size, physical characteristics, and requirements to prepare the jobsite for receiving of the particular manufactured item.

3.9.1.5 *Samples.* The term “samples” as used herein are physical examples furnished by Contractor to illustrate materials, equipment, or quality and includes natural materials, Fabricated items, equipment, devices, appliances, or parts thereof as called for in the Specifications, and any other samples as may be required by the Architect to determine whether the kind, quality, construction, finish, color, and other characteristics of the materials, etc., proposed by the Contractor conform to the required characteristics of the various parts of the Work. All Work shall be in accordance with the approved samples.

### 3.9.2 Shop Drawings.

3.9.2.1 *When Shop Drawings Are Required.* Shop Drawings are required for prefabricated components and for installation and coordination of these prefabricated components into the Project. In addition, Shop Drawings, are prepared to address the actual size and installation of components from various Subcontractors and provides an opportunity for the Contractor to coordinate and address conflicts between the subcontracting trades. In some cases, each Subcontractor or trade will provide Shop Drawings in a BIM format or other format as agreed by District.

3.9.2.2 *Purpose for Shop Drawings.* Shop Drawings are the Contractor’s manufacturer, Subcontractor, supplier, vendor or the Contractor’s detailed drawings showing particularized

## GENERAL CONDITIONS

method for assembly, specifics to a manufacturer, manufacturer component installation requirements, specifics as to a manufactured item, alterations to a manufactured, a custom created item, or drawn version of more detailed information expanding on the Architect's design shown in the Contract Documents. The Shop Drawings address the appearance, performance, size, weight, characteristics and prescriptive descriptions associated with the Contractor or Contractor's Subcontractor's plan for installation or assembly based on the design in the Specifications and Contract Documents. The Shop Drawing often is more detailed than the information shown in the Contract Documents to give the Architect and Engineer the opportunity to review the fabricator's version of the product (along with particulars specific to that particular product), prior to fabrication. References to the Contract Documents, Construction Documents, Drawings, Plans, and Specifications assist the Architect and Engineer in their review of the Shop Drawings. Attachment of manufacturer's material Specifications, "catalog cut sheets," and other manufacturer's information may be provided to accompany Shop Drawings. Because Shop Drawings facilitate the Architect's and Engineer's approval of the system, they should be as clear and complete as possible so they may be reviewed by Architect or Engineer for the Project.

3.9.2.3 *Shop Drawing Requirements.* The Contractor shall obtain and submit with Shop Drawings all seismic and other calculations and all Product Data from equipment manufacturers. "Product Data" as used herein are illustrations, standard schedules, performance charts, instructions, brochures, diagrams, and other information furnished by the Contractor to illustrate a material, product, or system for some portion of the Work.

3.9.2.4 *Not a Reproduction of Architectural or Engineering Drawings.* The Shop Drawings are not a reproduction of the architectural or engineering Drawings. Instead, they must show more detail than the Construction Documents and details the fabrication and/or installation of the items to the manufacturer's production crew or Contractor's installation crews.

3.9.2.5 *Shop Drawings Engineering Requirements:* Some Shop Drawings require an engineer stamp to be affixed on the Drawings and calculations. In such cases, a current and valid engineering stamp shall be affixed by a California registered engineer. No out of State engineers shall stamp Shop Drawings. (See DSA IR A-18). In most cases, an engineer means California registered mechanical, structural, electrical or plumbing engineer. California Registered Civil Engineers will not be accepted for structural details unless specifically approved by DSA.

3.9.2.6 *DSA Approvals Required Prior to Work.* No work on a Shop Drawing that requires DSA approval may proceed until DSA approval is received. Contractor has provided DSA approval time and allowed adequate time for corrections in Contractor's Schedule as required pursuant to Article 8.

3.9.2.7 *Shop Drawing Identification.* All Shop Drawings must be properly identified with the name of the Project and dated, and accompanied by a letter of transmittal referring to the name of the Project and to the Specification section number for identification of each item clearly stating in narrative form, as well as "clouding" all qualifications, departures, or deviations from the Contract Documents. Shop Drawings, for each section of the Work shall be numbered consecutively and the numbering system shall be retained throughout all revisions. All Subcontractor submissions shall be made through the Contractor. Each drawing shall have a clear space for the stamps of Architect and Contractor.

### 3.9.3 Deferred Approvals

Deferred approvals shall be submitted and processed to ensure all DSA and other governmental approvals are secured so as to not delay the Project. There may be additional requirements



## GENERAL CONDITIONS

for Deferred Approvals at Division 1 of the Specifications. All Deferred Approvals shall be prepared by Contractor or Contractor's agent early enough so as to not delay the Project. Contractor is aware that Title 24 California Code of Regulations Section 4-317 have specific requirements for Deferred Approval as to governing agencies and as to the Architect and Engineer for the Project. As a result, any delay associated with the time for approval by applicable agencies or by the Architect or Architect's consultants shall be Contractor's. Contractor is required to comply with inclusion of Deferred Approvals in the Schedule as required under Article 3.9.6 *DSA Approvals Required Prior to Work*. No work on a Deferred Approval item may proceed on the components until DSA approval is received. Contractor has provided DSA approval time and allowed adequate time for any DSA revisions in Contractor's Schedule as required pursuant to Article 8.

### 3.9.4 Submittals and Samples

3.9.4.1 *Information Required With Submittals:* Manufacturer, trade name, model or type number and quantities: Information provided must be of sufficient detail to allow Architect and Engineer to compare the submitted item with the specified products and acceptable products listed, in the Specifications and addenda.

3.9.4.2 *Description of Use and Performance Characteristics:* Information should be furnished describing the normal use and expected performance of the product. The Architect and Contractor review this information to confirm that the product is appropriate for the intended use.

3.9.4.3 *Size and Physical Characteristics:* The size and physical characteristics, such as adjustment capabilities, which is reviewed by both the Contractor and Architect. The Contractor has the most available information for comparing adjoining materials and equipment. The Contractor also needs to know the size and weight of the equipment for lifting and handling considerations.

3.9.4.4 *Finish Characteristics:* The Architect reviews the available finishes and selects the appropriate finish, if the finish was not previously specified in the documents. The Contractor should confirm that finish requirements in the Specifications are being met by the product.

3.9.4.5 *Contractor Responsible for Jobsite Dimensions:* Some material is custom-fabricated to job conditions, requiring dimensions from the jobsite. These jobsite dimensions are provided by the Contractor as part of the Contractor's responsibilities for the Project and shall be provided prior to release of the product for manufacture. Contractor shall not rely on Architect or Engineers to provide jobsite dimensions.

3.9.4.6 *Full Range of Samples Required (When Specific Items Not Specified).* Except in cases where the exact color and type of item is specified since the District is utilizing items Standardized or pre-selected by District, the full range of color, graining, texture, or other characteristics are anticipated for review in finished products, a sufficient number of samples of the specified materials shall be furnished by the Contractor to indicate the full range of characteristics which will be present in the finished products. Products delivered or erected without Submittal and approval without providing a full range of samples shall be subject to rejection. Except for range samples, and unless otherwise called for in the various sections of the Specifications or Specification Section 1, samples shall be submitted in duplicate.

3.9.4.7 *Labeling of Samples.* All samples shall be marked, tagged, or otherwise properly identified with the name of the submitting party, the name of the Project, the purpose for which the samples are submitted and the date.

## GENERAL CONDITIONS

3.9.4.8 *Transmittal letter.* All samples shall be accompanied by a letter of transmittal containing similar information, together with the Specification section number.

3.9.4.9 *Labels and Instructions.* All samples of materials shall be supplied with the manufacturer's descriptive labels and application instructions. Each tag or sticker shall have clear space for the review stamps of Contractor and Architect.

3.9.4.10 *Architect's Review.* The Architect will review and, if appropriate, approve submissions and will return them to the Contractor with the Architect's stamp and signature applied thereto, indicating the timing for review and appropriate action in compliance with the Architect's (or District's) standard procedures. In the cases where a CM is hired by the District, CM may be the party that receives and performance logging and initial processing of the Samples. CM may, in some cases, reject samples that are not in conformance with Contract requirements.

### 3.9.5 Submittal Submission Procedure

3.9.5.1 *Transmittal Letter and Other Requirements.* All Submittals must be properly identified with the name of the Project and dated, and each lot submitted must be accompanied by a letter of transmittal referring to the name of the Project and to the Specification section number for identification of each item clearly stating in narrative form, as well as "clouding" on the submissions, all qualifications, departures, or deviations from the Contract Documents. Shop Drawings, for each section of the Work shall be numbered consecutively and the numbering system shall be retained throughout all revisions. All Subcontractor submissions shall be made through the Contractor. Each drawing shall have a clear space for the stamps of Architect and Contractor. Refer to Specification Section 01 3300 – Submittals for additional submittal requirements. In the case where a CM is hired on the Project, the CM may be designated to receive the Submittals for the Project, log the Submittals, and in some cases reject Submittals that do not conform to Contract requirements. Submittal Procedures for further information.

3.9.5.2 *Copies Required.* Refer to Specification Section 01 3300 – submittals for electronic submittal requirements, which in most cases supersede need for non-digital prints. Each Submittal shall include one (1) legible, reproducible (if electronic is available, electronic copies shall also be provided) and five (5) legible prints of each drawing or schedule, table, cut sheet, etc., including fabrication, erection, layout and setting drawings, and such other drawings as required under the various sections of the Specifications, until final acceptance thereof is obtained. Subcontractor shall submit copies, in an amount as requested by the Contractor, of: (1) manufacturers' descriptive data for materials, equipment, and fixtures, including catalog sheets showing dimensions, performance, characteristics, and capacities; (2) wiring diagrams and controls; (3) schedules; (4) all seismic calculations and other calculations; and (5) other pertinent information as required by the District or Architect. (See also Division 1)

3.9.5.3 *Corrections.* The Contractor shall make all corrections required by Architect, District or CM and shall resubmit, as required by Architect or CM, corrected copies of Shop Drawings or new samples until approved. Contractor shall direct specific attention in writing or on resubmitted Shop Drawings to revisions other than the corrections required by the Architect on previous submissions. Professional services required for more than one (1) re-review of required Submittals of Shop Drawings, Product Data, or samples are subject to charge to the Contractor pursuant to Article 4.5.

3.9.5.4 *Approval Prior to Commencement of Work.* No portion of the Work requiring a Shop Drawing or sample submission or other Submittal shall be commenced until the submission has been reviewed by Contractor and Architect (and CM, if applicable) and approved by

## GENERAL CONDITIONS

Architect (and CM where applicable) unless specifically directed in writing by the Architect. All such portions of the Work shall be in accordance with approved Shop Drawings and samples.

3.9.5.5 *District's Property.* All Submittals, Shop Drawings, computer disks, BIM modeling information, clash checks, schedules, annotated Specifications, samples and other Submittals shall become the District's property upon receipt by the District or Architect.

### 3.9.6 Schedule Requirements for Submittals

Contractor shall obtain and shall submit all required Submittals (i.e. Shop Drawings, Deferred Approvals, Samples, etc.), in accordance with Contractor's "Schedule for Submission of Shop Drawings and Samples" as required in the scheduling portion of the General Conditions at Articles 8 and the Specifications (as long as the Specifications do not conflict with General Conditions. In the case of conflict, the conflicting provision shall be controlled by the General Conditions and the remaining Specifications sections shall be interpreted as if the general conditions language is inserted) with such promptness as to cause no delay in its own Work or in that of any other contractor or subcontractor but in no event later than thirty five (35) days after the Notice to Proceed is issued except in the specific cases noted as an exception under Article 3.7.2.1. No extensions of time will be granted to Contractor or any Subcontractor because of its failure to have Shop Drawings and samples submitted in accordance with Division 1 and the Schedule. Each Subcontractor shall submit all Shop Drawings, samples, and manufacturer's descriptive data for the review of the District, the Contractor, and the Architect through the Contractor.

3.9.6.1 *Consideration of Schedule.* Contractor has considered lead times, DSA or other agency governmental review times, Architect or Engineer review times, manufacturing seasons, and specific long lead procurement concerns for all submittals for the Project.

### 3.9.7 General Submittal Requirements

3.9.7.1 *Contractor Submittal Representations and Coordination.* By submitting Shop Drawings, Product Data, samples, etc., the Contractor represents that it has determined and verified all materials, field measurements, catalog numbers, related field construction criteria, and other relevant data in connection with each such submission, and that it has checked, verified, and coordinated the information contained within such Submittals with the requirements of the Work and of the Contract Documents, including the construction schedule.

3.9.7.2 *Contractor Coordination.* Contractor shall stamp, sign, and date each Submittal indicating its representation that the Submittal meets all of the requirements of the Contract Documents and evidence Contractor's review through execution of the following stamp to be placed on each Shop Drawings:

"[Contractor] has reviewed and approved the field dimensions and the construction criteria, and has also made written notation regarding any information in the Shop Drawings and Submittals that does not conform to the Contract Documents. This Shop Drawing or Submittal has been coordinated with all other Shop Drawings and Submittals received to date by me as Contractor and this duty of coordination has not been delegated to Subcontractors, material suppliers, the Architect, or the Engineers on this Project.

\_\_\_\_\_  
Signature of Contractor and date

## **GENERAL CONDITIONS**

3.9.7.3 *No Deviation from Contract Documents.* The submission of the Shop Drawings, Product Data, samples, etc., shall not deviate from the *requirements* of the Contract Documents including detailing and design intent which is specifically outlined in Contract Documents except as specifically authorized by the Architect or through an accepted substitution pursuant to Article 3.10.4. All deviations from the Contract Documents shall be narratively described in a transmittal accompanying the Shop Drawings. However, Shop Drawings shall not be used as a means of requesting a substitution, the procedure for which is defined in Article 3.10.4, “Substitutions.”

3.9.7.4 *Contractor Responsibility for Shop Drawings Conformance to Contract Documents.* Review by District and Architect shall not relieve the Contractor or any Subcontractor from its responsibility in preparing and submitting proper Shop Drawings in accordance with the Contract Documents.

3.9.7.5 *Incomplete Submittals.* Any submission, which in Architect’s opinion is incomplete, contains errors, or has been checked superficially, will be returned not reviewed by the Architect for resubmission by the Contractor. Refer to Submittal Procedures of the Specifications for additional information. The Contractor shall be responsible for any related delays and shall not be the basis for any Claim.

3.9.7.6 *Shop Drawings and Submittals Shall Not Be Used as a Method to Make a Substitution.* Shop Drawings and Submittals shall not be used as a means of requesting a substitution or to make changes in the Contract Documents. If changes are made to the Contract Documents through the Shop Drawings, the Architect shall have the right to reject the Submittal. If the Architect does not note the deviation from the approved Plans and Specifications, the Contractor is still responsible for the change and the Architect or the District may require the Shop Drawings be revised to properly reflect the approved Contract Documents. The Architect or District may also require that the Contractor bear all costs under Article 4.5 and consequential damages associated with a CCD to revise Plans and Specifications to accommodate the deviation from approved Plans and Specifications.

3.9.7.7 Extent of Review. In reviewing Shop Drawings, the Architect will not verify dimensions and field conditions. The Architect will review and approve Shop Drawings, Product Data, samples, etc., for aesthetics and for conformance with the design concept of the Work and the information in the Contract Documents. The Architect’s review shall neither be construed as a complete check which relieves the Contractor, Subcontractor, manufacturer, fabricator, or supplier from responsibility for any deficiency that may exist or from any departures or deviations from the requirements of the Contract Documents unless the Contractor has, in writing, called the Architect’s attention to the deviations at the time of submission. The Architect’s review shall not relieve the Contractor or Subcontractors from responsibility for errors of any sort in Shop Drawings or schedules, for proper fitting of the Work, coordination of the differing Subcontractor trades and Shop Drawings and Work which is not indicated on the Shop Drawings at the time of submission of Shop Drawings. Contractor and Subcontractors shall be solely responsible for any quantities which may be shown on the Submittals or Contract Documents.

### 3.10 **SUBSTITUTIONS**

#### 3.10.1 Definition

A Substitution is a change in product, material, equipment, or method of construction from those required by the Construction Documents proposed by the Contractor. For this Project, a Substitution is subject to the filing of a Request For Substitution Form at the time of bid and meeting the requirements of this Article and Specification Section 01 1600 – Product Requirements.

## GENERAL CONDITIONS

### 3.10.2 One Product Specified

Unless the Specifications state that no substitution is permitted, whenever the Contract Documents indicate any specific article, device, equipment, product, material, fixture, patented process, form, method, or type of construction or any specific name, make, trade name, or catalog number, with or without the words “or equal,” such specification shall be deemed to be used for the purpose of facilitating description of the material, process, or article desired and shall be deemed to be followed by the words “or equal.” Subject to the requirements of properly submitting a Substitution Request for as Addressed in Article 3.10.4, the Contractor may, unless otherwise stated, offer any material, process, article, etc., which shall be materially equal or better in every respect to that so indicated or specified (“Specified Item”) and will completely accomplish the purpose of the Contract Documents.

### 3.10.3 Products Specified Which Are Commercially Unavailable

If the Contractor fails to make a request for substitutions for products, prior to the submission of its bid, and such products subsequently become commercially unavailable, the Contractor may request a substitution for such commercially unavailable item. The decision to grant this request is solely at the District’s discretion. The written approval of the District, consistent with the procedure for Change Orders, shall be required for the use of a proposed substitute material. The District may condition its approval of the substitution upon the delivery to District of an extended warranty or other assurances of adequate performance of the substitution as well as an equitable deduction in the Contract Price should the substituted item cost less than the Specified Item. All risks of delay due the approval of a requested substitution by the DSA, or any other governmental agency having jurisdiction, shall be on the requesting party. All additional costs, DSA review costs, all procurement and construction delays, and all costs for review by the Architect or its consultants shall be the responsibility of the Contractor and will be deducted from Contractor’s pay request.

### 3.10.4 Substitution Request Form

Requests for substitutions of products, materials, or processes in place of a Specified Item must be in writing on the Request For Substitution Form (“Request Form”) during the time of submitting bids to the District as established by Specification Section 01 6000, article 3.01, except as provided for in Article 3.10.3.

The Request Form must be accompanied by evidence as to whether the proposed substitution:

- a. Is equal in quality/service/ability to the Specified Item;
- b. Will entail no changes in detail, construction, and scheduling of related work;
- c. Will be acceptable in consideration of the required design and artistic effect;
- d. Will provide no cost disadvantage to the District;
- e. Will require no excessive or more expensive maintenance, including adequacy and availability of replacement parts; and
- f. Will required no change of the construction schedule.

## **GENERAL CONDITIONS**

In the event that the bidder has agreed in the Request Form to provide the Specified Item and the District denies the bidder's requested substitution for a Specified Item, the bidder shall provide the Specified Item without any additional cost or charge to the District.

After the District's receipt of such evidence by the bidder, the District will make its final decision as to whether the bidder's request for substitution for any Specified Items will be granted. The decision as to whether a proposed request for substitution is equal to a Specified Item shall be at the sole discretion of the District. Any request for substitution that is granted by the District shall be documented and processed through a Bid Clarification, Addendum or Change Order. Contractor must submit a complete Submittal of the requested substitution and a Shop Drawing showing configuration, dimensions, and other critical information associated with the substitution that meets the requirements of Article 3.9. The District may condition its approval of any substitution upon delivery to the District of an extended warranty or other assurances of adequate performance of the substitution. Any and all risks of delay due to approval by the DSA or any other governmental agency having jurisdiction shall be on the bidder.

If the Architect and District accept a proposed substitution, the Contractor agrees to pay for all DSA review costs, engineering and design services, including, without limitation, compensation to the Architect and affected engineers for their required time to process such substitution through the Division of the State Architect, if required, and to make all changes and adjustments in materials or the work of all trades directly or indirectly affected by the substituted item or items at no cost to the District.

### 3.10.5 Substitution Requests After Bid

The District, in its sole discretion, may accept a request for substitution by the Contractor or may request Contractor substitute a specified item. Any substitutions requested after bids are opened shall be subject to the same conditions and requirements set forth in Article 3.10.4 above. If any substitutions, that in the District or Architect's determination, results in a credit to the District, the credit amount shall be agreed upon in writing, otherwise, the request for substitution shall be deemed denied.

## 3.11 INTEGRATION OF WORK

### 3.11.1 Scope

The Contractor shall be responsible for cutting, fitting, or patching to complete the Work and to make all parts fit together properly. Contractor shall be responsible for ensuring that all trades are coordinated and scheduled so as to ensure the timely and proper execution of the work. When modifying existing work or installing new Work adjacent to existing work, Contractor shall match, as closely as conditions of Site and materials will allow, the finishes, textures, and colors of the original work, refinishing existing work at no additional cost to District. All cost caused by defective or ill-timed work shall be borne by Contractor. Contractor shall be solely responsible for protecting existing work on adjacent properties and shall obtain all required permits for shoring and excavations near property lines.

### 3.11.2 Structural Members

New or existing structural members and elements, including reinforcing bars and seismic bracing, shall not be cut, bored, or drilled except by written authority of the Architect. Work done contrary to such authority is at the Contractor's risk and subject to replacement at its own expense without reimbursement under the Contract. Schedule delays resulting from Agency approvals for unauthorized work shall be the Contractor's responsibility.

## **GENERAL CONDITIONS**

### 3.11.3 Subsequent Removal

Permission to patch any areas or items of the Work shall not constitute a waiver of the District's or the Architect's right to require complete removal and replacement of the areas or items of the Work if, in the opinion of the Architect or the District, the patching does not satisfactorily restore quality and appearance of the Work or does not otherwise conform to the Contract Documents.

### 3.12 CLEANING UP

#### 3.12.1 Contractor's Responsibility to Clean Up

Contractor at all times shall keep premises free from debris such as waste, dust, excess water, storm water runoffs, rubbish, and excess materials and equipment. Contractor shall not leave debris under, in, or about the premises, but shall promptly remove same from the premises and dispose of it in a lawful manner. Disposal receipts or dump tickets shall be furnished to the Architect within five (5) days of request.

Contractor shall remove rubbish and debris resulting from the Work on a daily basis. Contractor shall maintain the structures and Site in a clean and orderly condition at all times until acceptance of the Project by the District. Contractor shall keep its access driveways and adjacent streets, sidewalks, gutters and drains free of rubbish, debris and excess water by cleaning and removal each day. All concrete, sidewalks, and paths of travel shall be broom cleaned daily.

#### 3.12.2 General Final Clean-Up

Upon completion of Work, Contractor shall employ experience workers or professional cleaners for final cleaning. Contractor shall clean each surface to the condition expected in a normal, commercial, building cleaning and maintenance program including, but not limited to, the performed of the following:

- a. Clean interior and exterior of buildings, including fixtures, equipment, walls, floors, ceilings, roofs, window sills and ledges, horizontal projections, and any areas where debris has collected, so surfaces are free from foreign material or discoloration;
- b. Clean the Project site. The grounds should be cleared of any Contractor equipment, raked clean of debris and trash removed. Sweep paved areas broom clean;
- c. Repair or replace any damaged materials. Replace any chipped or broken glass;
- d. Remove any and all stains;
- e. Remove labels that aren't permanent labels;
- f. Clean and polish all glass, plumbing fixtures, equipment, finish hardware and similar finish surfaces. Remove any glazing compounds;
- g. Remove temporary utilities, fencing, barricades, planking, sanitary facilities and similar temporary facilities from Site;

## **GENERAL CONDITIONS**

- h. Remove temporary film that remains on any hardware, doors or other surfaces; and
- i. Seal the bottom and tops of all doors.

### 3.12.3 Special Clean-Up.

In addition to the general cleaning, the following special cleaning shall be done at the completion of the Work in accordance with the Specifications including, but not limited to:

- a. Remove putty stains from glazing, then wash and polish glazing;
- b. Remove marks, stains, fingerprints and other soil or dirt from painted, stained or decorated work;
- c. Remove temporary protection and clean and polish floors and waxed surfaces;
- d. Clean and polish hardware and plumbing trim; remove stains, dust, dirt, plaster and paint;
- e. Wipe surfaces of mechanical and electrical equipment;
- f. Remove spots, soil, plaster and paint from tile work, and wash tile;
- g. Clean all fixtures and equipment, remove excess lubrication, clean light fixtures and lamps, polish metal surfaces;
- h. Vacuum-clean carpeted surfaces; and
- i. Remove debris from roofs, down spout and drainage system.

### 3.12.4 Failure to Cleanup

If the Contractor fails to clean up as provided in the Contract Documents, the District may do so, and the cost thereof shall be the responsibility of the Contractor pursuant to Article 2.2 and seek a Deductive Change Order.

## 3.13 **ACCESS TO WORK**

The Contractor shall provide the District, the Architect, Engineers and the Inspector of Record, access to the Work in preparation and progress wherever located. Contractor shall provide safe and proper facilities for such access so that District's representatives may perform their functions.

CONTRACTOR IS AWARE THAT THIS CONTRACT MAY BE SPLIT INTO SEVERAL PHASES AS ADDRESSED IN ARTICLE 6.

### 3.13.1 Special Inspection, Inspections or Tests Out of State, Out of Country or Remote from Project

If Contractor has a Subcontractor or supplier that requires in plant or special inspections or inspections or tests that are out of the country, out of the state, or a distance of more than 200 miles from



## **GENERAL CONDITIONS**

the Project site, the Special Inspector or Inspector shall be provided access so the special inspection or inspection may occur in the remote location. In some cases, the DSA Inspector may also require access in addition to Special Inspectors and individuals performing tests. Inspections/tests shall occur during normal work hours. (See also Article 4.3.6)

### **3.14 ROYALTIES AND PATENTS**

#### **3.14.1 Payment and Indemnity for Infringement**

Contractor shall hold and save the District and its officers, agents, and employees, the Construction Manager, the Architect, and the Architect's consultants harmless from liability of any nature or kind, including cost and expense, for or on account of any patented or unpatented invention, process, article, or appliance manufactured or used in the performance of the Contract, including its use by the District, unless otherwise specifically provided in the Contract Documents, and unless such liability arises from the sole negligence, or active negligence, or willful misconduct of the District, the Architect, or the Architect's consultants.

#### **3.14.2 Review**

The review by the Architect of any method of construction, invention, appliance, process, article, device, or material of any kind shall be for its adequacy for the Work and shall not be an approval for the use by the Contractor in violation of any patent or other rights of any person or entity.

### **3.15 INDEMNIFICATION**

#### **3.15.1 Contractor**

See Agreement Form. Contractor shall ensure that its contract with each of its Subcontractors contains provisions requiring the Subcontractors to defend, indemnify and hold harmless the District, Architect, Inspector, the State of California to a minimum level as set forth in this Article and consistent with the indemnity and hold harmless language in the Agreement Form.

The Contractor's and Subcontractors' obligation to defend, indemnify and hold harmless the District, Architect, Inspector, the State of California and their officers, employees, agents and independent contractors hereunder shall include, without limitation, any and all claims, damages, and costs for the following: (1) any damages or injury to or death of any person, and damage or injury to, loss (including theft), or loss of use of, any property; (2) breach of any warranty, express or implied; (3) failure of the Contractor or Subcontractors to comply with any applicable governmental law, rule, regulation, or other requirement; (4) products installed in or used in connection with the Work; and (5) any claims of violation of the Americans with Disabilities Act ("ADA")

### **3.16 SUBMISSION OF DAILY REPORTS**

#### **3.16.1 General**

By 10:00 a.m. on the following business day, the Contractor shall enter a Daily Report utilizing the Architect provided Construction Administration Software for the previous day's Work. Daily Reports shall include applicable delivery tickets, listing all labor, materials, and equipment involved for that day. The District reserves the right to note inconsistencies or inaccuracies in the Daily Reports. In such cases, pertinent notes shall be entered by each party to explain points which cannot be resolved that day.

## **GENERAL CONDITIONS**

The Construction Administration Software will record all entries, comments and edits to the Daily Report. Daily Reports by Subcontractors or others shall be submitted through the Contractor.

### 3.16.2 Labor

The Daily Report shall show names of workers, classifications, hours worked and hourly rate. The locations where work occurred shall also be identified in the Daily Report. Project superintendent expenses are not allowed.

### 3.16.3 Materials

The Daily Report required shall describe and list quantities of materials used and unit costs.

### 3.16.4 Equipment

The Daily Report required shall show type of equipment, size, identification number, and hours of operation, including loading and transportation, if applicable, and hourly/daily cost. Move-on and move-off fees shall be noted.

### 3.16.5 Other Services and Expenditures

Other services and expenditures shall be described in the Daily Report in detail as the District requires.

### 3.16.6 Failure to Submit Daily Report

If Contractor does not submit its Daily Report by 10 am the next business day, the Inspector of Record shall prepare a Daily Report addressing each of the above items. The cost for the Inspector's services to prepare the Daily Report shall be addressed through a Deductive Change Order under Article 7.7.4.

## 3.17 **AS-BUILT DRAWINGS AND ANNOTATED SPECIFICATIONS**

Throughout the duration of the Project, Contractor shall maintain on a current basis an accurate and complete set of As-Built Drawings (and Annotated Specifications) clearly showing all changes, revisions to Specifications and substitutions during construction, including, without limitation, field changes and the final location of all electrical and mechanical equipment, utility lines, ducts, outlets, structural members, walls, partitions, and other significant features. In case a Specification allows Contractor to elect one of several brands, makes, or types of material or equipment, the annotations shall show which of the allowable items the Contractor has furnished. The Contractor will update the As-Built Drawings and Annotated Specifications as often as necessary to keep them current, but no less often than weekly.

Contractor shall update As-Built Drawings with complete information on an area of Work at or near the time when the Work is being performed and prior to any DSA 152 sign off and prior to any Work being covered.

The As-Built Drawings and Annotated Specifications shall be kept at the Site and available for review and inspection by the District and the Architect. Failure to maintain and update the As-Built Drawings is a basis to withhold Progress Payments pursuant to Article 9.6.

## **GENERAL CONDITIONS**

### 3.17.1 Upon Beneficial Occupancy

Contractor shall obtain and pay for reproducible Plans upon Beneficial Occupancy. Contractor shall deliver Plans to District Representative (Construction Manager if one is hired for the Project).

### 3.17.2 As-Builts at Completion of Work

Upon completion of the Work and prior to and as a condition precedent to Application for Retention Payment, the Contractor will provide one neatly prepared and complete set of As-Built Drawings and Annotated Specifications to the District, in hard copy and PDF indexed format.. Contractor shall certify the As-Builts as a complete and accurate reflection of the actual construction conditions of the Work by affixing a stamp indicating the Drawings are As-Builts and certifying accuracy on the final set of As-Builts. Failure to deliver a complete As-Built set of Drawings may result in significant withholdings to ensure Work is properly documented. (See Article 9.9.2)

### 3.17.3 Log of Control and Survey Documentation

Contractor shall complete and maintain an accurate log or all control and survey documentation for the Project as the Work progresses. All reference and control points shall be recorded on the As-Built Drawings. The basis of elevations shall be one of the established benchmarks that must be maintained on the As-Builts.

### 3.17.4 Record Coordinates for Key Items

Contractor shall record, by coordinates, all utilities on-site with top of pipe elevations, major grade and alignment changes, rim, grate or top of curb and flow line elevations of all drainage structures and sewer manholes. Contractor shall update record information at or near the time when work is occurring in an area and prior to DSA 152 sign off on any category of Work and prior to covering the Work.

### 3.17.5 BIM As-Built Drawings

If BIM is utilized for the Project, then an electronic version of such As-Built Drawings and Annotated Specifications will be delivered to District (in an acceptable format to District).

## 3.18 **EQUIPMENT MANUALS**

Contractor shall obtain and furnish three (3) complete sets of manuals containing the manufacturers' instructions for maintenance and operation of each item of equipment and apparatus furnished under the Contract Documents and any additional data specifically requested under the various sections of the Specifications for each division of the Work. The manuals shall be arranged in logical, sequential order, labeled, indexed, and placed in three-ring binders. Additionally an indexed PDF file of equipment manuals shall be provided. At the completion of its Work, the Contractor shall certify, by endorsement thereon, that each of the manuals is complete, accurate, and covers all of its Work. Prior to submittal of Contractor's Application for Retention Payment, and as a further condition to its approval by the Architect, each Subcontractor shall deliver the manuals, arranged in logical, sequential order, labeled, indexed, endorsed, and placed in three-ring binders, to the Contractor, who shall assemble these manuals for all divisions of the Work, review them for completeness, and submit them to the District through the Architect.

## **GENERAL CONDITIONS**

### **3.19 DIR REGISTRATION**

Strict compliance with all DIR registration requirements in accordance with Labor Code sections 1725.5 and 1771.1 is a material obligation of the Contractor and all of its subcontractors (of any tier) under the Contract Documents. The foregoing includes, without limitation, compliance with DIR registration requirements at all times during performance of the Work by the Contractor and all of its subcontractors of any tier. The failure of the Contractor and all subcontractors of any tier to be properly registered with DIR at all times during performance of the Work is a material breach of the Contract and subject to termination for cause.

An affirmative and ongoing obligation of the Contractor under the Contract Documents is the verification that all subcontractors of any tier are at all times during performance of the Work are in full and strict compliance with the DIR registration requirements. The Contractor shall not permit or allow any subcontractor of any tier to perform any Work without the Contractor's verification that all subcontractors are in full and strict compliance with the DIR registration requirements. Any subcontractors of any tier not properly registered with DIR shall be substituted in accordance with Labor Code section 1771.1. Contractor or its subcontractors of any tier shall not be entitled to any additional costs or time arising from or in any way related to compliance with the DIR registration requirements.

## **GENERAL CONDITIONS**

### **ARTICLE 4 ADMINISTRATION OF THE CONTRACT AND CLAIMS**

#### **4.1 ARCHITECT**

##### **4.1.1 Replacement of Architect**

In the case of the termination of the Architect, the District may appoint an Architect or another construction professional or may perform such functions with its own licensed professional personnel. The status of the replacement Architect under the Contract Documents shall be the same as that of the former Architect.

#### **4.2 ARCHITECT'S ADMINISTRATION OF THE CONTRACT**

##### **4.2.1 Status**

Pursuant to Titles 2 of the California Code of Regulations and as required pursuant to the Field Act, Education Code 17280 et seq., the Architect will provide administration of the Contract Documents and the Work, and will be the District's representative during construction, as well as during the one (1) year period following the commencement of any warranties. The Architect will have authority to act on behalf of the District only to the extent provided in the Contract Documents.

##### **4.2.2 Site Visits**

The Architect will visit the Site at intervals necessary in the judgment of the Architect to become generally familiar with the progress and quality of the Work and to determine in general if the Work is being performed in accordance with the Contract Documents and as otherwise required by DSA.

##### **4.2.3 Limitations of Construction Responsibility**

The Architect, District and CM shall not have control over, charge of, or be responsible for construction means, methods, techniques, schedules, sequences or procedures, fabrication, procurement, shipment, delivery, receipt, installation, or for safety precautions and programs in connection with the Work, since these are solely the Contractor's responsibility under the Contract Documents. The Architect, District and CM shall not be responsible for the Contractor's, Subcontractors', material or equipment suppliers', or any other person's schedules or failure to carry out the Work in accordance with the Contract Documents. The Architect, District and CM shall not have control over or charge of acts or omissions of the Contractor, Subcontractors, their agents or employees, or any other persons or entities performing or supplying portions of the Work. The Contractor shall not be relieved of obligations to perform the Work in accordance with the Contract Documents either by activities or duties of the Architect, District or CM in the Architect, District or CM's administration of the Contract Documents, or by tests, inspections, or approvals required or performed by persons other than the Contractor.

##### **4.2.4 Communications Facilitating Contract Administration**

Except when direct communications are warranted by special circumstances, the District and the Contractor shall communicate through the Architect, primarily through Architect provided Construction Administration Software which allows viewing and collaboration between District, Architect and Inspector. Where direct communication is necessary between the District and the Contractor, the

## GENERAL CONDITIONS

District's communication shall be through the District's authorized designated person. The Architect and CM shall be promptly informed, and shall receive copies of all written communications. Contractor shall not rely upon any communications from the District that is not from the District's Representative. Communications by and with the Architect's consultants shall be through the Architect. Communications by and with Subcontractors and material or equipment suppliers shall be through the Contractor. Copies of all communication should be sent to the Architect, District Representative and Inspector.

### 4.2.5 Payment Applications

The Architect will review and make recommendations to the District regarding the amounts due the Contractor on the Certificates for Payment pursuant to Article 9.3.4 and subject to the Inspector's review, (CM review, if applicable) and Architect's observation. This review of Payment Applications is sometimes called a "Pencil Draft." Return of a Pencil Draft shall constitute the District's dispute of the Payment Application that has been submitted. Contractor shall promptly respond to Pencil Drafts or Contractor's Payment Applications may be delayed. Contractor's failure to promptly respond to a Pencil Draft shall qualify as a delay in the Prompt Payment of a Request for Payment or Request for Retention.

### 4.2.6 Rejection of Work

In addition to the rights, duties, and obligations of the Inspector under this Article, the Architect may recommend to the District that the District reject Work which does not conform to the Contract Documents. Whenever the Architect considers it necessary or advisable to achieve the intent of the Contract Documents, the Architect (and/or CM) may recommend to the District that the District require additional inspection or testing of the Work in accordance with Article 13.5, whether or not such Work is Fabricated, installed, or completed. District may have Non-conforming Work removed and replaced pursuant to Article 9.7. However, neither this authority of the Architect (or CM) nor a decision made in good faith either to exercise or not to exercise such authority shall give rise to a duty or responsibility of the Architect (or CM) to the Contractor, Subcontractors, material and equipment suppliers, their agents or employees, or other persons performing portions of the Work.

Contractor shall, without charge, replace or correct Work found by the District to not be in conformance to Contract requirements. Contractor shall promptly segregate and remove rejected materials from the Project site.

This section is does not address a Notice of Non-Compliance and the remedies associated with a Notice of Non-Compliance which are addressed at Article 7.1.2

### 4.2.7 Warranties upon Completion

The Architect (and where applicable CM), in conjunction with the Inspector will conduct field reviews of the Work to determine the date of Substantial Completion and of Final Completion, shall receive and forward to the District for the District's review written warranties and related documents required by the Contract and assembled by the Contractor, and will issue a final Certificate for Payment when the Architect believes the Work has been completed in compliance with the requirements of the Contract Documents (See Article 9.11 for Close-Out). The handling by the Architect (or where applicable CM) of such warranties, maintenance manuals, or similar documents shall not diminish or transfer to the Architect any responsibilities or liabilities required by the Contract Documents of the Contractor or other entities, parties, or persons performing or supplying the Work.

## **GENERAL CONDITIONS**

On some Projects, the District will take a phased occupancy of the Project. In those cases, the District may commence the running of warranties on the buildings, or phases that are accepted after Punch List is completed and the District has accepted Completion of the separate phase. A separate Notice of Completion may be filed for the separate building or phase of work and warranties shall commence for the separate phase only to the extent that warranties do not require coordination or connection to other buildings or other parts of the site and only if the warranted item is completed to its entirety in the segregated building or phased area.

If written warranties are not provided at the time the Punch List is nearing completion, Architect (with recommendations from the CM and Inspector) shall determine the dollar value of the warranties and shall make recommendation for withholdings necessary to effectuate the transfer of such warranties to the District for future use as part of the Punch List for the Project pursuant to Article 9.6.

Warranties are not commenced through utilizing of equipment for testing and operation as necessary to acclimate buildings or where necessary to test systems.

### 4.2.8 Interpretation

The Architect will interpret and decide matters concerning performance and requirements of the Contract Documents. Architect shall make clarifications as necessary to interpret the Contract Documents.

## 4.3 **PROJECT INSPECTOR**

### 4.3.1 General

One or more Project Inspectors employed by the District and approved by the Division of the State Architect will be assigned to the Work in accordance with the requirements of Title 24 of the California Code of Regulations. The Inspector(s) duties are as specifically defined in Title 24 Section 4-333 and 4-342 and in DSA IR A-8.

### 4.3.2 Inspector's Duties and DSA Noted Timelines for Inspection

All Work shall be under the observation of the Inspector. Contractor shall establish a protocol for requesting inspection with Inspector so as to not delay the Work and provide adequate time for the Inspector to perform inspection. If such a protocol is not established ahead of time, Inspector may utilize the time criteria set by Title 24 of 48 hours in advance of submitting form DSA 156 for each new area. The Inspector shall have free access to any or all parts of the Work at any time. The Contractor shall furnish the Inspector such information as may be necessary to keep the Inspector fully informed regarding progress and manner of Work and character of materials. Such observations shall not, in any way, relieve the Contractor from responsibility for full compliance with all terms and conditions of the Contract, or be construed to lessen to any degree the Contractor's responsibility for providing efficient and capable superintendence. The Inspector is not authorized to make changes in the Drawings or Specifications nor shall the Inspector's approval of the Work and methods relieve the Contractor of responsibility for the correction of subsequently discovered defects, or from its obligation to comply with the Contract Documents.

Inspector shall electronically post DSA required documents on the DSA electronic posting website. It is the Contractor's responsibility to determine the status of posting and determine if all the

## GENERAL CONDITIONS

criteria for sign off of a category of Work on the Project Inspection Card (Form DSA 152) as defined more thoroughly in the most current version of the DSA 152 manual posted on the DSA website.

Inspector may collaborate with Contractor about approval of areas that may be constructed and approved incrementally under the DSA 152 card pursuant to the guidelines of PR-13 at Article 1.17. Inspector shall work with Contractor to present incremental approval proposals to DSA.

### 4.3.3 Inspector's Authority to Reject or Stop Work

The Inspector shall have the authority to reject Work whenever provisions of the Contract Documents are not being complied with, and Contractor shall instruct its Subcontractors and employees accordingly. In addition, the Inspector may stop any Work that poses a probable risk of harm to persons or property. The Contractor shall instruct its employees, Subcontractors, material and equipment suppliers, etc., accordingly. The absence of any Stop Work Order or rejection of any portion of the Work shall not relieve the Contractor from any of its obligations pursuant to the Contract Documents.

### 4.3.4 Inspector's Facilities

Within seven (7) days after the notice to proceed, the Contractor shall provide the Inspector with the temporary facilities as required. More specific requirements for the Inspector facilities may be further described under Division 1 of the Specifications.

### 4.3.5 Testing Times

The District will provide inspection and testing at its cost during the normal eight (8) hour day Monday through Friday (except holidays). Work by the Contractor outside of the normal eight (8) hour day shall constitute an authorization from the Contractor to the District to provide inspection and testing as required outside of the normal eight (8) hour day. Contractor shall provide adequate time for inspections so as to not delay the Work. An advanced timing protocol may be established pursuant to Article 4.3.2. If the Contractor is behind Schedule then it is incumbent on the Contractor to provide advance forecast through look ahead of the anticipated date for inspection so the Inspector may plan their activities so as to not delay the Project. Contractor shall reimburse District for any additional costs associated with inspection and testing (including re-inspection and re-testing) outside the normal eight-hour day and for any retests caused by the Contractor.

It is the Contractor's responsibility to request special inspections with sufficient time so all testing may be timely completed and posted so work may proceed and the Inspector's signature is attached to the Project Inspection Card (Form 152). Specifically, timely request for special inspection under the DSA Verified Report Forms 291 (laboratory), DSA Verified Report Form 292 (Special Inspection), and DSA Verified Report 293 (geotechnical) since DSA requirements under PR 13-01 specifically gives the Special Inspections 14 days to post to the DSA website. Failure to plan and pay (if applicable) for quicker delivery of Special Inspections may be counted as Float, but is not considered Governmental Delay Float under Article 8.1.4.

### 4.3.6 Special Inspections, Inspections or Tests Out of State, Out of Country or Remote from Project

If Contractor has a Subcontractor or supplier that requires in plant or special inspections, inspections or tests that are out of the country, out of the state or a distance of more than 200 miles from the Project Site, the District shall provide the Special Inspector or individual performing tests time for



## **GENERAL CONDITIONS**

inspection and testing during normal work hours. Contractor, however, is responsible for the cost of travel, housing, food, out of area premiums that may be in the Inspector/Testing Agreement with District, or other expenses necessary to ensure proper inspection, special inspection or testing is provided by a DSA Certified Inspector, Special Inspector, or individual performing tests. In some cases all three (DSA Inspector, Special Inspector, and Tester) may be required. In addition, if the DSA Certified Inspector, Special Inspector, or individual performing test has contractual travel clauses or special rates for out of town inspection, Contractor is responsible for all costs associated with the contractual travel costs in addition to all other costs. Arrangements for inspection and/or testing shall be made far enough in advance so as to not delay the Work.

### **4.4 STOP WORK ORDER**

DSA may issue a Stop Work Order, or an Order to Comply, when either (1) the Work proceeds without DSA approval; (2) the Work proceeds without a DSA Inspector of Record, or (3) where DSA determines that the Work is not being performed in accordance with applicable rules and regulations, and would compromise the structural integrity of the Project or would endanger lives. If a Stop Work Order is issued, the Work in the affected area shall cease until DSA withdraws the Stop Work Order. Pursuant to Education Code section 17307.5(b), the District shall not be held liable in any action filed against the District for any delays caused by compliance with the Stop Work Order, except to the extent that an error or omission by the District is the basis for the issuance of the Stop Work Order.

Examples of Stop Work Orders that may be issued by DSA include DSA Bulletin 07-04 and Policy 10-01, the installation of automatic fire sprinkler systems without approved Plans, covering Work that has not been approved by Inspector on DSA Project Inspection Card (Form 152).

### **4.5 RESPONSIBILITY FOR ADDITIONAL CHARGES INCURRED BY THE DISTRICT FOR PROFESSIONAL SERVICES**

If at any time prior to the completion of the requirements under the Contract Documents, the District is required to provide or secure additional professional services (including CM, Inspection, Architect, Engineering and Special Consultant Services) for any reason by any act of the Contractor, the District may seek a Deductive Change Order for any costs incurred for any such additional services, which costs shall be deducted from the next progress payment. A Deductive Change Order shall be independent from any other District remedies and shall not be considered a waiver of any District rights or remedies. If payments then or thereafter due to the Contractor are not sufficient to cover such amounts, the Contractor shall pay the difference to the District. Additional services shall include, but shall not be limited to, the following:

- a. Services made necessary by the default of the Contractor (Article 14 or Article 2.2).
- b. Services made necessary due to the defects or deficiencies in the Work of the Contractor (Article 2.2 and Article 9.6).
- c. Spurious or frivolous RFI's issued that do not conform to the requirements of Article 7.4. Issuance of the same RFI after receiving an answer from the Architect or Engineer
- d. Review of Schedules that are provided by Contractor that do not Conform with the Requirements of Article 8.

## **GENERAL CONDITIONS**

- e. Preparation of a CCD or WD to correct a Contractor Deficiency, or Contractor Caused Notice of Non-Compliance (See Article 7.3).
- f. Review of Incomplete Shop Drawings or Submittals, including the submission of Piecemeal Shop Drawings or Submittals unless piecemeal Submittals are specifically agreed upon by District (See Article 3.9)
- g. Services required by failure of the Contractor to perform according to any provision of the Contract Documents.
- h. Services in connection with evaluating substitutions of products, materials, equipment, Subcontractors' proposed by the Contractor, and making subsequent revisions to Drawings, Specifications, obtaining DSA approvals, DSA costs for review of CCD's, other governmental agency review costs, and providing other documentation required (except for the situation where the specified item is no longer manufactured or available). (See Article 3.10)
- i. Services for evaluating and processing Claims or Disputes submitted by the Contractor in connection with the Work outside the established Change Order process.
- j. Services required by the failure of the Contractor to prosecute the Work in a timely manner in compliance within the specified time of completion.
- k. Services in conjunction with the testing, adjusting, balancing and start-up of equipment other than the normal amount customarily associated for the type of Work involved.
- l. Services in conjunction with more than one (1) re-review of Submittals of Shop Drawings, Product Data, samples, RFI's etc.

### **4.6 DISPUTES AND CLAIMS**

#### **4.6.1 Decision of Architect**

“Disputes” or “Claims” as defined in Article 4.6.9.1 between District and Contractor involving money or time, including those alleging an error or omission by the Architect shall be referred initially to the Architect for action as provided in Article 4.6.2 within ten (10) days after Contractor's Article 7 request for Change is denied. If there is a CM, the CM shall receive the Dispute and may review and also assemble opinions and documents to assist the Architect. A decision by the Architect, as provided in Article 4.6.5, shall be required as a condition precedent to proceeding with remedies set forth in Article 4.6.9 as to all such matters arising prior to the date Retention Payment Application is due, regardless of whether such matters relate to execution and progress of the Work, or the extent to which the Work has reached Final Completion.

The condition precedent of an Architect decision shall be waived if: (1) the position of Architect is vacant; (2) the Architect has failed to take action required under Article 4.6.5 within the time periods required therein; or (3) the Dispute or Claim relates to a stop notice claim not arising from any extra Change Order or Immediate Change Directive for which approval has not been provided.

#### **4.6.2 Architect's Review**

## GENERAL CONDITIONS

The Architect (and CM) will review the Dispute and take one or more of the following preliminary actions upon receipt of a Dispute: (1) request additional supporting data from the claimant; (2) submit a schedule to the parties indicating when the Architect expects to take action; (3) reject the Dispute in whole or in part, stating reasons for rejection; (4) recommend approval of the Dispute; or (5) suggest a compromise. The Architect may also, but is not obligated to, notify the Surety, if any, of the nature and amount of the Dispute.

4.6.2.1 *Architectural Immunity.* Architect review of Disputes and Claims shall be impartial and meant to resolve Disputes and Claims. Pursuant to the case, Huber, Hunt & Nichols, Inc. v. Moore (1977) 67 Cal.App.3d 278, the Architect is provided a quasi-judicial immunity for interpreting and deciding Disputes and Claims between the District and Contractor.

### 4.6.3 Documentation if Resolved

If a Dispute has been resolved, the Architect (and/or CM) will prepare a Change Order or obtain appropriate documentation to document the terms for Board approval.

### 4.6.4 Actions if Not Resolved

If a Dispute has not been resolved and all documentation requested pursuant to Article 4.6.2 has been provided, the Contractor shall, within ten (10) days after the Architect's initial response, assemble all the documents involved in the Dispute including copies of all back-up documentation of costs and the basis for the Dispute and take one or more of the following actions: (1) modify the initial Dispute; (2) notify the Architect that the initial Dispute stands; or (3) supplement with additional supporting data and re-submit to the Architect under Article 4.6.2.

### 4.6.5 Architect's Written Decision

If a Dispute has not been resolved after consideration of the foregoing and of other evidence presented by the parties or requested by the Architect, the Architect (or Architect through CM) shall provide a written decision twenty (20) days after compliance with Article 4.6.4. Upon expiration of such time period, the Architect (or Architect through CM) will render to the parties its written decision relative to the Dispute, including any change in the Contract Sum or Contract Time or both. The Architect may also request reasonable additional time to complete Architect's written decision.

If the resolution of the Dispute by the Architect is not satisfactory to the Contractor and copies of all back-up documentation of costs and the basis for the Dispute is fully articulated in a package of material that is complete, the Contractor may then submit a Claim to the District under Article 4.6.9.

### 4.6.6 Continuing Contract Performance

Pending final resolution of a Dispute or Claim, including, negotiation, mediation, arbitration, or litigation, the Contractor shall proceed diligently with performance of the Contract, and the District shall continue to make any undisputed payments in accordance with the Contract (less any withholdings or offsets). If the Claim is not resolved, Contractor agrees it will neither rescind the Contract nor stop the progress of the work, but Contractor's sole remedy shall be to submit such controversy to determination by a court of competent jurisdiction in the county where the Project is located, after the Project has been completed, and not before.

## GENERAL CONDITIONS

4.6.6.1 *District's Option to Submit Individual Disputes to Arbitration during Claims and Disputes Process.* At the District's sole option, in order to more efficiently resolve Claims during the Project and prior to the completion of the Claims Process, pursuant to Government Code section 9201, the District may submit individual Disputes or Claims for binding arbitration and Contractor agrees to the resolution of for each individual Dispute or Claim by an Arbitrator, including resolution of time and delays. If binding arbitration is utilized for individual Disputes or Claims, such resolution is full and final as to that particular Dispute or Claim. THIS INDIVIDUAL DISPUTE ARBITRATION PROCESS IS NOT AN ARBITRATION CLAUSE AND SHALL NOT BE CONSTRUED AS AN AGREEMENT TO ARBITRATE. THIS INDIVIDUAL DISPUTES ARBITRATION PROCESS IS FOR THE SOLE PURPOSE OF STREAMLINING AND RESOLVING DISPUTES OR CLAIMS DURING CONSTRUCTION AND SHALL BE REQUESTED ON SPECIFIC INDIVIDUAL ITEMS BY THE DISTRICT PRIOR TO RETENTION PAYMENT (EVEN IF THERE ARE DEDUCTIONS MADE FROM RETENTION PAYMENT) WHICH REPRESENTS THE FINAL COMPLETION OF THE PROJECT.

- a. If there is no Retention remaining on the Project, individual Disputes initiated prior to Project Final Completion shall continue until a final disposition of the Arbitration or resolution of the individual Claim or Dispute.
- b. No Tolling. The Arbitration process shall not toll the Disputes or Claims process under Article 4.6 or the requirement to submit Claims to Court under Article 4.6.9.5.

### 4.6.7 Claims for Concealed Trenches or Excavations Greater Than Four Feet Below the Surface

When any excavation or trenching extends greater than four feet below the surface or if any condition involving hazardous substances are encountered:

- a. Immediately upon discovery, The Contractor shall promptly, and before the following conditions are disturbed, notify the District, by telephone and in writing, of the condition except:
  1. If such condition is a hazardous waste condition, Contractor's bid includes removal or disposal of hazardous substances. Material that the Contractor believes may be a material that is hazardous waste, as defined in Section 25117 of the Health and Safety Code, is required to be removed to a Class I, Class II, or Class III disposal site in accordance with the provisions of existing law. In such case, the notice bulletin procedures of Article 7 apply.
  2. Subsurface or latent physical conditions at the Site differing from those indicated in the Drawings, Specifications, Soils Report, and from Contractor's own investigation under Article 2.1.
  3. Unknown physical conditions at the Site of any unusual nature, different materially from those ordinarily encountered and generally recognized as inherent in Work of the character provided for in the Contract.

## GENERAL CONDITIONS

- b. The District shall investigate the conditions, and if District finds that the conditions do materially so differ, do involve hazardous waste, and cause a decrease or increase in the Contractor's cost of, or the time required for, performance of any part of the Work shall issue a Change Order or Construction Change Document under the procedures described in the Contract.
- c. In the event that a dispute arises between the public entity or District and the Contractor whether the conditions materially differ, involve hazardous waste, or cause a decrease or increase in the Contractor's cost of, or time required for, performance of any part of the Work, the Contractor shall not be excused from any scheduled Completion Date provided for by the Contract, but shall proceed with all Work to be performed under the Contract. The Contractor shall retain any and all rights provided either by Contract or by law which pertain to the resolution of disputes and protests between the contracting parties.

### 4.6.8 Dispute Concerning Extension of Time.

If Contractor and District cannot agree upon an extension of time, whether compensable or not, then Contractor must have first completed the procedures set forth in Article 8.4. Upon completion of the procedures set forth under Article 8.4, Contractor must then comply with the requirements in this Article including those set forth under Article 4.6.9.

### 4.6.9 Claims Procedures

Pursuant to the remedies under Public Contract Code section 9201 and Government Code section 930.2, Contractor, through execution of this Agreement, also agrees to comply with the Claims requirements of Article 4.6 to quickly and efficiently resolve Disputes and Claims. Further, to provide a level of accuracy to the records submitted, the District shall have the right to audit books and records pursuant to Article 13.11 based on the actual costs incurred and to reduce the uncertainty in resolving Disputes and Claims with limited information.

#### 4.6.9.1 *Procedure Applicable to All Claims*

- a. Definition of Claim: A "Claim" is where a Dispute between the parties rises to the level where backup documentation is assembled and provided to the District as a separate demand by the Contractor for: (1) a time extension, including, without limitation, for relief from damages or penalties for delay assessed by the District under the Contract; (2) payment by the District of money or damages arising from Work done by, or on behalf of, the Contractor pursuant to the Contract and payment for which is not otherwise expressly provided for or to which the Contractor is not otherwise entitled to; or (3) an amount of payment disputed by the District. If the Claim is for damages associated with a DSA Stop Work Order, the Contractor shall not be entitled to a request for Compensation, but shall be entitled to utilize Governmental Delay Float (See Article 8.1.4.1.)
- b. Filing Claim Is Not Basis to Discontinue Work: The Contractor shall promptly comply with Work under the Contract or Work requested by the District even though a written Claim has been filed. The Contractor and

## GENERAL CONDITIONS

the District shall make good faith efforts to resolve any and all Claims that may arise during the performance of the Work covered by this Contract.

- c. Claim Notification: The Contractor shall within seven (7) calendar days after the written decision of the Architect, or if the time period for Architect's decision has passed under Article 4.6.5, submit a notification in writing sent by registered mail or certified mail with return receipt requested, with the District (and the District's CM) stating clearly the basis for the Claim and including all relevant and required documents. If the notification is not submitted within seven (7) days after the written decision of the Architect or the passage of time under Article 4.6.5, the Contractor shall be deemed to have waived all right to assert the Claim, and the Claim shall be denied. Claims submitted after the Retention Payment date shall also be considered null and void by the District. All Claims shall be reviewed pursuant to Articles 4.6.1 through 4.6.5.

The Formal Notification of Claim must be presented as follows:

- (1) The term "Claim" must be at the top of the page in no smaller than 20 point writing.
  - (2) All documentation submitted pursuant to Article 4.6 to the Architect shall be submitted with the "Claim."
  - (3) A stack of documents, copy of all Project documents, or the submission of random documents shall not constitute an adequate reference to supporting documentation.
  - (4) Any additional or supporting documentation that Contractor believes is relevant should be submitted at this time.
- d. Reasonable Documents to Support Claim: The Contractor shall furnish reasonable documentation to support the Claim. The Contractor shall provide all written detailed documentation which supports the Claim, including but not limited to: arguments, justifications, cost, estimates, Schedule analysis and detailed documentation. The format of the required reasonable documentation to support the Claim shall include, without limitation:
1. Cover letter.
  2. Summary of factual basis of Claim and amount of Claim.
  3. Summary of the basis of the Claim, including the specific clause and section under the Contract under which the Claim is made.
  4. Documents relating to the Claim, including:
    - a. Specifications sections in question.
    - b. Relevant portions of the Drawings

## GENERAL CONDITIONS

- c. Applicable Clarifications (RFI's)
  - d. Other relevant information, including responses that were received.
  - e. Contractor Analysis of Claim merit.
    - (a) Contractor's analysis of any Subcontractor vendor Claims that are being passed through.
    - (b) Any analysis performed by outside consultants
    - (c) Any legal analysis that Contractor deems relevant
  - f. Break down of all costs associated with the Claim.
  - g. For Claims relating to time extensions, an analysis and supporting documentation evidencing any effect upon the critical path in conformance with the requirements of Article 8.4 chronology of events and related correspondence.
  - h. Applicable Daily Reports and logs.
    - (a) If the Daily Reports or Logs are not available, lost or destroyed, there shall be a presumption that the lost documentation was unfavorable to the Contractor. See California Civil Jury Instruction 204.
  - i. For Claims involving overhead, cost escalation, acceleration, disruption or increased costs, a full version of job costs reports organized by category of work or Schedule of Values with budget information tracked against actual costs. Any and all supporting back-up data, including the original bid (and associated original unaltered metadata).
    - (a) The metadata and bid information shall be provided confidentially and subject to a protective order to prevent dissemination to other contractors or to the public. However, the bid documentation should remain intact and available for review and inspection in case of this type of increased cost Claim.
    - (b) This data on the bid shall be made available to any District attorneys or experts and shall also be utilized as evidence for any legal proceedings.
    - (c) If the bid documentation is not available, lost or destroyed, there shall be a presumption that the lost bid documentation was unfavorable to the Contractor. See California Civil Jury Instruction 204.
- e. Certification: The Contractor (and Subcontractors, if applicable) shall submit with the Claim a certification under penalty of perjury:
- 1. That the Contractor has reviewed the Claim and that such Claim is made in good faith;

## GENERAL CONDITIONS

2. Supporting data are accurate and complete to the best of the Contractor's knowledge and belief;
  3. The amount requested accurately reflects the amount of compensation for which the Contractor believes the District is liable.
  4. That the Contractor is familiar with Government Code sections 12650 et seq. and Penal Code section 72 and that false claims can lead to substantial fines and/or imprisonment.
- f. Signature of Certification: If the Contractor is not an individual, the certification shall be executed by an officer or general partner of the Contractor having overall responsibility for the conduct of the Contractor's affairs.
- g. Upon receipt of a Claim and all supporting documents as required above, the District shall conduct a reasonable review of the Claim and, within a period not to exceed 45 days, shall provide the Contractor a written statement identifying what portion of the Claim is disputed and what portion is undisputed. Upon receipt of a Claim, the District and Contractor may, by mutual agreement, extend the time period provided in this paragraph.
- h. If the District needs approval from its governing Board to provide the Contractor a written statement identifying the disputed portion and the undisputed portion of the Claim, and the governing Board does not meet within the 45 days or within the mutually agreed to extension of time following receipt of a Claim sent by registered mail or certified mail, return receipt requested, the District shall have up to three days following the next duly publicly noticed meeting of the governing Board after the 45-day period, or extension, expires to provide the Contractor a written statement identifying the disputed portion and the undisputed portion.
- i. Any payment due on an undisputed portion of the Claim shall be processed and made within 60 days after the District issues its written statement. If the District fails to issue a written statement, paragraph o below shall apply.
- j. If the Contractor disputes the District's written response, or if the District fails to respond to a Claim issued pursuant to this Article 4.6.9 within the time prescribed, the Contractor may demand in writing an informal conference to meet and confer for settlement of the issues in dispute. Upon receipt of a demand in writing sent by registered mail or certified mail, return receipt requested, the District shall schedule a meet and confer conference within 30 days for settlement of the Claim.
- k. Within 10 business days following the conclusion of the meet and confer conference, if the Claim or any portion of the Claim remains in dispute, the District shall provide the Contractor a written statement identifying the



## GENERAL CONDITIONS

portion of the Claim that remains in dispute and the portion that is undisputed. Any payment due on an undisputed portion of the Claim shall be processed and made within 60 days after the District issues its written statement. Any disputed portion of the Claim, as identified by the Contractor in writing, shall be submitted to nonbinding mediation, with the District and the Contractor sharing the associated costs equally. The District and Contractor shall mutually agree to a mediator within 10 business days after the disputed portion of the Claim has been identified in writing. If the parties cannot agree upon a mediator, each party shall select a mediator and those mediators shall select a qualified neutral third party to mediate with regard to the disputed portion of the Claim. Each party shall bear the fees and costs charged by its respective mediator in connection with the selection of the neutral mediator. If mediation is unsuccessful, the parts of the Claim remaining in dispute shall be subject to applicable procedures in Article 4.6.9.5.

- l. For purposes of this Article 4.6.9, mediation includes any nonbinding process, including, but not limited to, neutral evaluation or a dispute review board, in which an independent third party or board assists the parties in dispute resolution through negotiation or by issuance of an evaluation. Any mediation utilized shall conform to the timeframes in this section.
- m. Unless otherwise agreed to by the District and the Contractor in writing, the mediation conducted pursuant to this Article 4.6.9 shall excuse any further obligation under Section 20104.4 to mediate after litigation has been commenced.
- n. This Claims process does not preclude the District from requiring arbitration of disputes under private arbitration or the Public Works Contract Arbitration Program, if mediation under this Article 4.6.9 does not resolve the parties' Claim. This Claims process does not preclude the District from submitting individual Disputes or Claims to binding arbitration pursuant to Article 4.6.9.4 below.
- o. Failure by the District to respond to a Claim from the Contractor within the time periods described in this subdivision or to otherwise meet the time requirements of this Article 4.6.9 shall result in the Claim being deemed rejected in its entirety. A Claim that is denied by reason of the District's failure to have responded to a Claim, or its failure to otherwise meet the time requirements of this Article 4.6.9, shall not constitute an adverse finding with regard to the merits of the Claim or the responsibility or qualifications of the Contractor.
- p. If a subcontractor or a lower tier subcontractor lacks legal standing to assert a Claim against a District because privity of contract does not exist, the Contractor may present to the District a Claim on behalf of a subcontractor or lower tier subcontractor. A subcontractor may request in writing, either on his or her own behalf or on behalf of a lower tier subcontractor, that the Contractor present a Claim for work which was

## GENERAL CONDITIONS

performed by the subcontractor or by a lower tier subcontractor on behalf of the subcontractor. The subcontractor requesting that the Claim be presented to the District shall furnish reasonable documentation to support the Claim. Within 45 days of receipt of this written request, the Contractor shall notify the subcontractor in writing as to whether the Contractor presented the Claim to the District and, if the Contractor did not present the Claim, provide the subcontractor with a statement of the reasons for not having done so.

- q. Upon receipt of a Claim, the parties may mutually agree to waive, in writing, mediation and proceed directly to the commencement of a civil action or binding arbitration, as applicable.
- r. The Contractor's Claim shall be denied if it fails to follow the requirements of this Article.

4.6.9.2 *District (through CM or District's Agent or Attorney) May Request Additional Information.* Within thirty (30) days of receipt of the Claim and the information under this Article, the District may request in writing any additional documentation supporting the Claim or documentation relating to defenses to the Claim which the District may assert. If additional documents are required, the time in which the Claim is evaluated may be extended by a reasonable time so the Claim and additional documents may be reviewed.

4.6.9.3 *Claims Procedures in Addition to Government Code Claim.* Nothing in the Claims procedures set forth in this Article 4 of the General Conditions shall act to waive or relieve the Contractor from meeting the requirements set forth in Government Code section 900 et seq.

4.6.9.4 *Binding Arbitration of Individual Claim Issues.* To expedite resolution of Claims pursuant to Public Contract Code section 9201, at the District's sole option, the District may submit individual Claims to Arbitration prior to Retention Payment consistent with the requirements of Article 4.6.6.1.

4.6.9.5 *Resolution of Claims in Court of Competent Jurisdiction.* If Claims are not resolved under the procedure set forth and pursuant to Article 4.6.9, such Claim or controversy shall be submitted to a court in the County of the location of the Project after the Project has been completed, and not before.

4.6.9.6 *Warranties, Guarantees and Obligations.* The duties and obligations imposed by these General Conditions and the rights and remedies available hereunder to the parties hereto, and, in particular but without limitation, the warranties, guarantees and obligations imposed upon Contractor by the General Conditions and amendments thereto; and all of the rights and remedies available to District and Architect thereunder, are in addition to, and are not to be construed in any way as a limitation of, any rights and remedies available to any or all of them which are otherwise imposed or available by laws or regulations by special warranty or guarantee or by other provisions of the Contract Documents, and the provisions of this Article will be as effective as if repeated specifically in the Contract Documents in connection with each particular duty, obligation, right and remedy to which they apply.

## **GENERAL CONDITIONS**

### **ARTICLE 5 SUBCONTRACTORS**

#### **5.1 DEFINITIONS**

##### **5.1.1 Subcontractual Relations Bound to Same Contract Terms at General Contractor**

By appropriate agreement, written where legally required for validity, the Contractor shall require each Subcontractor, to the extent of the Work to be performed by the Subcontractor, to be bound to the Contractor by terms of the Contract Documents, and to assume toward the Contractor all the same obligations and responsibilities, assumed by Contractor pursuant to the Contract Documents. Each subcontract agreement shall preserve and protect the rights of the District and the Architect under the Contract Documents with respect to the Work to be performed by the Subcontractor so that subcontracting thereof will not prejudice such rights. Where appropriate, the Contractor shall require each Subcontractor to enter into similar agreements with Sub-subcontractors. The Contractor shall make available to each proposed Subcontractor, prior to the execution of the subcontract agreement, copies of the Contract Documents to which the Subcontractor will be bound. Upon written request of the Subcontractor, the Contractor shall identify to the Subcontractor the terms and conditions of the proposed subcontract agreement, which may be at variance with the Contract Documents. Subcontractors shall similarly make copies of applicable portions of such documents available to their respective proposed Sub-subcontractors.

##### **5.1.2 Subcontractor Licenses and DIR Registration**

All Subcontractors shall be properly licensed by the California State Licensing Board. All Subcontractors (of any tier) performing any portion of the Work must comply with the Labor Code sections 1725.5 and 1771.1 and must be properly and currently registered with the California Department of Industrial Relations and qualified to perform public works pursuant to Labor Code section 1725.5 throughout the duration of the Project. No portion of the Work is permitted to be performed by a Subcontractor of any tier unless the subcontractor is properly registered with DIR. Any Subcontractors of any tier not properly registered with DIR shall be substituted in accordance with Labor Code section 1771.1.

##### **5.1.3 Substitution of Subcontractor**

Substitution of Subcontractors shall be permitted only as authorized under Public Contract Code §§ 4107 et seq. Any substitutions of Subcontractors shall not result in any increase in the Contract Price or result in the granting of any extension of time for the completion of the Project.

##### **5.1.4 Contingent Assignment of Subcontracts and Other Contracts**

Each subcontract, purchase order, vendor contract or agreement for any portion of the Work is hereby assigned by the Contractor to the District provided that:

- a. Such assignment is effective only after Termination of this Contract with the Contractor by the District as provided under Article 14 and only for those subcontracts and other contracts and agreements that the District accepts by notifying the Subcontractor or Materialman (as may be applicable) in writing; and
- b. Such assignment is subject to the prior rights of the Surety(ies) obligated under the Payment Bond and Performance Bond.

## **GENERAL CONDITIONS**

- c. The Contractor shall include adequate provisions for this contingent assignment of subcontracts and other contracts and agreements in each such document.

## GENERAL CONDITIONS

### ARTICLE 6 CONSTRUCTION BY DISTRICT OR BY SEPARATE CONTRACTORS

#### 6.1 DISTRICT'S RIGHT TO PERFORM CONSTRUCTION AND TO AWARD SEPARATE CONTRACTS

##### 6.1.1 Separate Contracts.

6.1.1.1 District reserves the right to let other contracts in connection with this Work. Contractor shall afford other contractors reasonable opportunity for (1) introduction and storage of their materials; (2) access to the Work; and (3) execution of their work. Contractor shall properly connect and coordinate its work with that of other Contractors.

6.1.1.2 If any part of Contractor's Work depends on proper execution or results of any other contractor, the Contractor shall inspect and within seven (7) days or less, report to Architect, in writing, any defects in such work that render it unsuitable for proper execution of Contractor's Work. Contractor will be held accountable for damages to District for that Work which it failed to inspect or should have inspected. Contractor's failure to inspect and report shall constitute its acceptance of other contractors' Work as fit and proper for reception of its Work, except as to defects which may develop in other contractors' work after execution of Contractor's work.

6.1.1.3 To ensure proper execution of its subsequent Work, Contractor shall measure and inspect Work already in place and shall at once report to the Architect in writing any discrepancy between executed Work as built and the Contract Documents.

6.1.1.4 Contractor shall ascertain to its own satisfaction the scope of the Project and nature of any other contracts that have been or may be awarded by District in prosecution of the Project and the potential impact of such Work on the Baseline Schedule or Schedule updates.

6.1.1.5 Nothing herein contained shall be interpreted as granting to Contractor the exclusive occupancy at the site of Project. Contractor shall not cause any unnecessary hindrance or delay to any other contractor working on the Project Site. If execution of any contract by the District is likely to cause interference with Contractor's performance of this Contract, once Contractor provides District timely written notice and identifies the Schedule Conflict, District shall decide which contractor shall cease work temporarily and which contractor shall continue, or whether Work can be coordinated so that contractors may proceed simultaneously.

6.1.1.6 District shall not be responsible for any damages suffered or extra costs incurred by Contractor resulting directly or indirectly from award or performance or attempted performance of any other contract or contracts at the Project necessary for the performance of the Project (examples include Electrical Utility Contractor, separate offsite contractor, a separate grading contractor, furniture installation etc.)

**CONTRACTOR IS AWARE THAT THIS CONTRACT MAY BE SPLIT INTO SEVERAL PHASES BASED ON DOCUMENTATION PROVIDED WITH THIS BID OR DISCUSSED AT THE JOB WALK. CONTRACTOR HAS MADE ALLOWANCE FOR ANY DELAYS OR DAMAGES WHICH MAY ARISE FROM COORDINATION WITH CONTRACTORS REQUIRED FOR OTHER PHASES. IF ANY DELAYS SHOULD ARISE FROM ANOTHER CONTRACTOR**

## GENERAL CONDITIONS

**WORKING ON A DIFFERENT PHASE, CONTRACTOR'S SOLE REMEDY FOR DAMAGES, INCLUDING DELAY DAMAGES, SHALL BE AGAINST THE CONTRACTOR WHO CAUSED SUCH DAMAGE AND NOT THE DISTRICT. CONTRACTOR SHALL PROVIDE ACCESS TO OTHER CONTRACTORS FOR OTHER PHASES AS NECESSARY TO PREVENT DELAYS AND DAMAGES TO OTHER CONTRACTORS WORKING ON OTHER PHASES OF CONSTRUCTION.**

### 6.1.2 District's Right to Carry Out the Work

(See Article 2.2)

### 6.1.3 Designation as Contractor

When separate contracts are awarded to contractors on the Project Site, the term "Contractor" in the Contract Documents in each case shall mean the Contractor who executes each separate District/Contractor Agreement.

### 6.1.4 District Notice to the Contractor of Other Contractors

The Contractor shall have overall responsibility to reasonably coordinate and schedule Contractor's activities with the activities of the District's forces and of each separate contractor with the Work of the Contractor, who shall cooperate with them. The Contractor shall participate with other separate contractors and the District in reviewing their construction schedules when:

- a. Notice is provided in the Contract Documents of other scope of Work,
- b. In the case where there is known Work to be performed by other Contractors
- c. For outside contractors hired by utilities
- d. Where the Contract Document provides "Work by Others" or "By Others"
- e. Where specifically noted during the Pre-Bid Conference
- f. Where specifically noted in the Mandatory Job Walk
- g. By CO or ICD,
- h. With respect to the installation of :
  1. Furniture,
  2. Electronics and networking equipment,
  3. Cabling,
  4. Low voltage,
  5. Off-site work,
  6. Grading (when by a separate contractor),
  7. Environmental remediation when excluded by the Contract Documents (i.e. asbestos, lead or other hazardous waste removal)
  8. Deep cleaning crews,

## **GENERAL CONDITIONS**

9. Commissioning and testing,
10. Keying and re-keying,
11. Programming

6.1.4.1 Exception where no Coordination is Required on the Part of the Contractor for Turn Key Operations. If the Contractor has specifically outlined a “Turn Key” or “Complete Delivery” of a final completed operational school in writing as part of the Baseline Schedule..

6.1.4.2 The Contractor shall make any revisions to the Baseline Schedule (or Schedule Update) and Contract Sum deemed necessary after a joint review and mutual agreement. The Baseline Schedule (or Schedule Update) shall then constitute the Schedules to be used by the Contractor, separate contractors, and the District until subsequently revised. Additionally, Contractor shall coordinate with Architect, District, and Inspector to ensure timely and proper progress of Work.

### **6.2 CONSTRUCTIVE OWNERSHIP OF PROJECT SITE AND MATERIAL**

Upon commencement of Work, the Contractor becomes the constructive owner of the entire site, improvements, material and equipment on Project site. Contractor must ensure proper safety and storage of all materials and assumes responsibility as if Contractor was the owner of the Project site. All risk of loss or damage shall be borne by Contractor during the Work until the date of Completion. As constructive owner of the Project site, Contractor must carry adequate insurance in case of calamity and is not entitled to rely on the insurance requirements as set forth in this Agreement as being adequate coverage in case of calamity.

### **6.3 DISTRICT’S RIGHT TO CLEAN UP**

If a dispute arises among the Contractor, separate contractors, and the District as to the responsibility under their respective contracts for maintaining the premises and surrounding area free from waste materials and rubbish as described in Article 3.12, the District may clean up and allocate the cost among those it deems responsible.

## GENERAL CONDITIONS

### **ARTICLE 7 CHANGES IN THE WORK**

#### 7.1 CHANGES

##### 7.1.1 No Changes Without Authorization

There shall be no change whatsoever in the Drawings, Specifications, or in the Work without an executed Change Order, Change Order Request, Immediate Change Directive, or order by the Architect for a minor change in the Work as herein provided. District shall not be liable for the cost of any extra work or any substitutions, changes, additions, omissions, or deviations from the Drawings and Specifications unless the District's Governing Board or designated representative with delegated authority (subject to Board ratification) has authorized the same and the cost thereof approved in writing by Change Order or executed Construction Change Document. No extension of time for performance of the Work shall be allowed hereunder unless claim for such extension is made at the time changes in the Work are ordered, and such time duly adjusted in writing in the Change Order. The provisions of the Contract Documents shall apply to all such changes, additions, and omissions with the same effect as if originally embodied in the Drawings and Specifications. Notwithstanding anything to the contrary in this Article 7, all Change Orders shall be prepared and issued by the Architect and shall become effective when executed by the District's Governing Board, the Architect, and the Contractor.

Should any Change Order result in an increase in the Contract Price, the cost of such Change Order shall be agreed to, in writing, in advance by Contractor and District and be subject to the monetary limitations set forth in Public Contract Code section 20118.4 (Please check with the District since there are different interpretations of the limitations of Public Contract Code section 20118.4 depending on the County the Project is located). In the event that Contractor proceeds with any change in Work without first notifying District and obtaining the Architect's and District's consent to a Change Order, Contractor waives any Claim of additional compensation for such additional work and Contractor takes the risk that a Notice of Non-Compliance may issue, a critical path Project delay may occur, and the Contractor will also be responsible for the cost of preparation and DSA CCD review fees for a corrective DSA approved Construction Change Document.

**CONTRACTOR UNDERSTANDS, ACKNOWLEDGES, AND AGREES THAT THE REASON FOR THIS NOTICE REQUIREMENT IS SO THAT DISTRICT MAY HAVE AN OPPORTUNITY TO ANALYZE THE WORK AND DECIDE WHETHER THE DISTRICT SHALL PROCEED WITH THE CHANGE ORDER OR ALTER THE PROJECT SO THAT SUCH CHANGE IN WORK BECOMES UNNECESSARY AND TO AVOID THE POSSIBLE DELAYS ASSOCIATED WITH THE ISSUANCE OF A NOTICE OF NON-COMPLIANCE.**

##### 7.1.2 Notices of Non-Compliance

Contractor deviation or changes from approved Plans and Specifications may result in the issuance of a Notice of Non-Compliance (See DSA Form 154). Contractor is specifically notified that deviations from the Plans and Specifications, whether major or minor, may result in the requirement to obtain a DSA Construction Change Document to correct the Notice of Non-Compliance. (See Article 7.3.1 for Definition of CCD). In some cases, the lack of a DSA approved CCD AND verification from the Inspector that a Notice of Non-Compliance has been corrected may result in a critical path delay to the next stage of Work on the Project. Specifically, a deviation from approved Plans and Specifications may prevent



## **GENERAL CONDITIONS**

approval of the category of Work listed in the DSA 152 Project Inspection Card. Any delays that are caused by the Contractor's deviation from approved Plans and Specifications shall be the Contractor's responsibility.

### 7.1.3 Architect Authority

The Architect will have authority to order minor changes in the Work that do not involve DSA Approval not involving any adjustment in the Contract Sum, or an extension of the Contract Time.

## 7.2 **CHANGE ORDERS ("CO")**

A CO is a written instrument prepared by the Architect and signed by the District (as authorized by the District's Governing Board), the Contractor, and the Architect stating their agreement upon all of the following:

- a. A description of a change in the Work;
- b. The amount of the adjustment in the Contract Sum, if any; and
- c. The extent of the adjustment in the Contract Time, if any.

A CO may be comprised of ICD's, Response to RFP's and COR's

## 7.3 **CONSTRUCTION CHANGE DOCUMENT (CCD Category A, and CCD Category B) and WORK DIRECTIVE (WD)**

### 7.3.1 Definitions

7.3.1.1 *Construction Change Document (CCD)*. A Construction Change Document is a DSA term that is utilized to address changes to the DSA approved Plans and Specifications. There are two types of Construction Change Documents. (1) DSA approved CCD Category A for Work affecting structural, access compliance or fire/ life safety of the Project which will require a DSA approval; and, (2) CCD Category B for work NOT affecting structural safety, access compliance or fire/ life safety that will not require a DSA approval (except to confirm that no approval is required). Both CCD Category A and Category B shall be set forth in DSA Form 140 and submitted to DSA as required.

7.3.1.2 *Work Directive (ICD)*. A Work Directive is a written order to the Contractor prepared by the Architect and signed by the District (and CM if there is a CM on the Project) and the Architect, directing a change in the Work and stating a proposed basis for adjustment, if any, in the Contract Sum or Contract Time, or both. The District may by WD, without invalidating the Contract, direct immediate changes in the Work within the general scope of the Contract consisting of additions, deletions, or other revisions within. If applicable, the Contract Sum and Contract Time will be adjusted accordingly.

In the case of an Work Directive being issued, Contractor must commence Work immediately or delays from failure to perform the WD shall be the responsibility of Contractor and the failure to move forward with Work immediately shall also be grounds for Termination under Article 14.

A WD does not automatically trigger an Article 7.6 Dispute or Claim. Contractor must timely follow the procedures outlined at Article 7.6 and 4.6 where applicable.

## **GENERAL CONDITIONS**

Refer to Division 1 and Supplementary General Conditions for a copy of the proposed Immediate Change Directive form.

### 7.3.2 Use to Direct Change

A WD shall be used to move work forward immediately and to avoid delay. In some cases, a WD shall be issued in the absence of agreement on the terms of a CO, COR, or RFP. A copy of an ICD form is provided in the Supplementary General Conditions and Division 1. The anticipated not to exceed price for the Work will be inserted into the WD. In the case of an WD issued to correct Contractor Deficiencies or to correct a Contractor caused Notice of Non-Compliance, the WD may be issued with \$0 and no additional time. Contract may prepare a COR associated with the WD pursuant to Article 7. However, Contractor shall proceed with all Work required under an Approved WD immediately upon issuance. Failure to proceed with the Work under an WD shall be grounds for Termination for Cause under Article 14 or take over the Work under Article 2.2.

If adequate time exists, a WD may be subject of an RFP for pricing and determination if any time that may be required. However, if an RFP is not completed, Contractor shall immediately commence Work when a WD is issued. If the RFP is incomplete, it may still be completed to be submitted for pricing purposes as long as the RFP is submitted within the timeline provided by the RFP, or within 10 days following issuance of the WD.

### 7.3.3 WD Issued Over a Notice of Non-Compliance or to Cover Work Subject to a DSA 152 Sign Off

In some cases, an WD shall be for the purpose of proceeding with Work to keep the Project on Schedule and as an acknowledgement by the District that Contractor is proceeding with Work contrary to a Notice of Non-Compliance, prior to issuance of a DSA approved CCD Category A, or to direct the covering of Work which has not yet received a DSA 152 Inspection Approval to move forward.

7.3.3.1 *Contractor Compliance with all Aspects of a WD.* Contractor is to undertake the WD and comply with all aspects of the Work outlined in the WD. Inspector is to inspect the Work pursuant to the WD. Failure to follow the WD may result in deduction of the ICD Work under Article 2.2 or Termination of the Contractor pursuant to Article 14.

7.3.3.2 *Exception in the Case of DSA Issued Stop Work Order.* Contractor must proceed with an WD even if a CCD has not been approved by DSA except in the case of a DSA issued Stop Work Order. If a DSA Stop Work Order is issued, Contractor must stop work and wait further direction from the District.

7.3.3.3 *WD Due to Contractor Deficiency or Contractor Caused Notice of Non-Compliance.* If a WD is issued to correct a Contractor Deficiency or a Contractor caused notice of Non-Compliance, Contractor specifically acknowledges responsibility for all consequential damages associated with the Contractor Deficiency or Contractor caused Notice of Non-Compliance and all consequential damages and costs incurred to correct the deficiency under Article 4.5

## 7.4 **REQUEST FOR INFORMATION (“RFI”)**

### 7.4.1 Definition

## **GENERAL CONDITIONS**

A RFI is a written request prepared by the Contractor requesting the Architect to provide additional information necessary to clarify or amplify an item which the Contractor believes is not clearly shown or called for in the Drawings or Specifications, or to address problems which have arisen under field conditions.

7.4.1.1 A RFI shall not be used as a vehicle to generate time extensions.

7.4.1.2 Resubmission of the same or similar RFI is not acceptable. RFI's that are similar should be addressed in Project meetings where the requestor (Contractor, Subcontractor or vendor) is able to address the particular issue with the Architect or Engineer and a resolution addressed in the minutes.

7.4.1.3 A RFI response applicable to a specific area cannot be extended to other situations unless specifically addressed in writing within the RFI or in a separate RFI.

7.4.1.4 RFI's should provide a proposed solution and should adequately describe the problem that has arisen.

### 7.4.2 Scope

The RFI shall reference all the applicable Contract Documents including Specification section, detail, page numbers, Drawing numbers, and sheet numbers, etc. The Contractor shall make suggestions and interpretations of the issue raised by the RFI. An RFI cannot modify the Contract Cost, Contract Time, or the Contract Documents.

### 7.4.3 Response Time

The Architect must respond to a RFI within a reasonable time after receiving such request. If the Architect's response results in a change in the Work, then such change shall be effected by a written CO, COR RFP or WD, if appropriate. If the Architect cannot respond to the RFI within a reasonable time, the Architect shall notify the Contractor, with a copy to the Inspector and the District, of the amount of time that will be required to respond.

### 7.4.4 Costs Incurred

The Contractor shall be responsible for any costs incurred for professional services as more fully set forth in Article 4.5, which shall be subject to a Deductive Change Order, if an RFI requests an interpretation or decision of a matter where the information sought is equally available to the party making such request. District, at its sole discretion, shall issue a Deductive Change Order to Contractor for all such professional services arising from this Article.

## 7.5 **REQUEST FOR PROPOSAL ("RFP")**

### 7.5.1 Definition

A RFP is a written request prepared by the Architect (and/or CM) requesting the Contractor to submit to the District and the Architect an estimate of the effect of a proposed change on the Contract Price and (if applicable) the Contract Time. If Architect issues a Bulletin, the Changed items in the Bulletin shall be addressed as an RFP and all responses shall be prepared to a Bulletin as addressed in this Article 7.5. A form RFP is included in the Division 1 documents.

## **GENERAL CONDITIONS**

### 7.5.2 Scope

A RFP shall contain adequate information, including any necessary Drawings and Specifications, to enable Contractor to provide the cost breakdowns required by Article 7.7. The Contractor shall not be entitled to any Additional Compensation for preparing a response to an RFP, whether ultimately accepted or not.

### 7.5.3 Response Time

Contractor shall respond to an RFP within ten (10) days or the time period otherwise set forth in the RFP.

## 7.6 **CHANGE ORDER REQUEST (“COR”)**

### 7.6.1 Definition

A COR is a written request prepared by the Contractor supported by backup documentation requesting that the District and the Architect issue a CO based upon a proposed change, cost, time, or cost and time that may be incurred on the Project or arising from an RFP, WD, or CCD.

### 7.6.2 Changes in Price

A COR shall include breakdowns per Article 7.7 to validate any change in Contract Price due to proposed change or Claim.

### 7.6.3 Changes in Time

A COR shall also include any additional time required to complete the Project only if the delay is a critical path delay. Any additional time requested shall not be the number of days to make the proposed change, but must be based upon the impact to the Project Schedule as defined in Article 8. A schedule fragnet showing the time delay must be submitted with the COR. Any changes in time will be granted only if there is an impact to the critical path. If Contractor fails to request a time extension in a COR, then the Contractor is thereafter precluded from requesting or claiming a delay.

## 7.7 **COST OF CHANGE ORDERS**

### 7.7.1 Scope

Within ten (10) days after a request is made for a change that impacts the Contract Sum as defined in Article 9.1, the critical path, or the Contract Time as defined in Article 8.1.1, the Contractor shall provide the District and the Architect, with a written estimate of the effect of the proposed CO upon the Contract Sum and the actual cost of construction, which shall include a complete itemized cost breakdown of all labor and material showing actual quantities, hours, unit prices, and wage rates required for the change, and the effect upon the Contract Time of such CO. Changes may be made by District by an appropriate written CO, or, at the District’s option, such changes shall be implemented immediately upon the Contractor’s receipt of an appropriate written Construction Change Document.

District may, as provided by law and without affecting the validity of this Agreement, order changes, modification, deletions and extra work by issuance of written CO or CCD from time to time during the progress of the Project, Contract Sum being adjusted accordingly. All such Work shall be executed

## GENERAL CONDITIONS

under conditions of the original Agreement except that any extension of time caused thereby shall be adjusted at time of ordering such change. District has discretion to order changes on a “time and material” basis with adjustments to time made after Contractor has justified through documentation the impact on the critical path of the Project.

7.7.1.1 *Time and Material Charges.* If the District orders Work on a “time and material” basis, timesheets shall be signed daily by the Inspector or District Representative at or near the time the Work is actually undertaken and shall show the hours worked, and the Work actually completed. No time sheets shall be signed the next day. A copy shall be provided to the Person signing the document at the time the document is signed, but not before 10 am the following day.

### 7.7.2 Determination of Cost

The amount of the increase or decrease in the Contract Price from a CO or COR, if any, shall be determined in one or more of the following ways as applicable to a specific situation:

- a. Mutual acceptance of a lump sum properly itemized and supported by sufficient substantiating data to permit evaluation. If an agreement cannot be reached within fifteen (15) days after submission and negotiation of Contractor’s proposal, Contractor may submit pursuant to Article 7.7.3. Submission of sums which have no basis in fact are at the sole risk of Contractor and may be a violation of the False Claims Act set forth under Government Code section 12650 et seq.);
  1. If the District objects to 7.7.2(a) as a method for submission due to inaccuracies in the submitted amount, overstatement of manpower or time required to perform the CO, or unreliability of the data provided, the District may either have the Architect or a professional estimator determine the cost for the CO, and the applicable time extension, or the Contractor shall utilize Article 7.7.2(d) or 7.7.3.
  2. Once the District provides a written objection to use of Article 7.7.2(a) due to unreliability of the estimated price, the Contractor shall no longer utilize mutual acceptance of a lump sum as a method for submission of CO’s and shall provide a breakdown of estimated or actual costs pursuant to Article 7.7.2(d) or 7.7.3
- b. By unit prices contained in Contractor’s original bid and incorporated in the Project documents or fixed by subsequent agreement between District and Contractor;
- c. Cost to be determined in a manner agreed upon by the parties and a mutually acceptable fixed or percentage fee. However, in the case of disagreement, Contractor must utilize the procedure under Article 7.7.3; or
- d. By cost of material and labor and percentage of overhead and profit. If the value is determined by this method the following requirements shall apply:
  1. *Basis for Establishing Costs*

## GENERAL CONDITIONS

- (1) Labor will be the cost for wages prevailing locally for each craft or type of workers at the time the extra Work is done, plus employer payments of payroll taxes and workers compensation insurance (exclude insurance costs as part of the overhead and profit mark-up), health and welfare, pension, vacation, apprenticeship funds, and other direct costs resulting from Federal, State, or local laws, as well as assessments or benefits required by lawful collective bargaining agreements. In no case shall the total labor costs exceed the applicable prevailing wage rate for that particular classification. The use of a labor classification which would increase the extra Work cost will not be permitted unless the Contractor establishes the necessity for such additional costs. Labor costs for equipment operators and helpers shall be reported only when such costs are not included in the invoice for equipment rental.
- (2) Materials shall be at invoice or lowest current price at which such materials are locally available and delivered to the Site in the quantities involved, plus sales tax, freight, and delivery. The District reserves the right to approve materials and sources of supply or to supply materials to the Contractor if necessary for the progress of the Work. No markup shall be applied to any material provided by the District.
- (3) Tool and Equipment Rental. No payment will be made for the use of tools which have a replacement value of \$250 or less.

Regardless of ownership, the rates to be used in determining equipment rental costs shall not exceed listed rates prevailing locally at equipment rental agencies or distributors at the time the Work is performed. Rates applied shall be appropriate based on actual equipment need and usage. Monthly, weekly or other extended use rates that results in the lowest cost shall be applied if equipment is used on site for extended periods.

The rental rates paid shall include the cost of fuel, oil, lubrication, supplies, small tools, necessary attachments, repairs and maintenance of any kind, depreciation, storage, insurance, and all incidentals.

Necessary loading and transportation costs for equipment used on the extra Work shall be included. If equipment is used intermittently and, when not in use, could be returned to its rental source at less expense to the District than holding it at the Work Site, it shall be returned unless the Contractor elects to keep it at the Work Site at no expense to the District.

All equipment shall be acceptable to the Inspector, in good working condition, and suitable for the purpose for which it is to be used. Manufacturer's ratings and modifications shall be used to classify equipment, and equipment shall be powered by a unit of at least the minimum rating recommended by the manufacturer.

**GENERAL CONDITIONS**

If tool and equipment charges are part of a Dispute, Claim, or Appeal, the District reserves the right to utilize actual costs for tools and equipment or a depreciation rate for equipment based on audit finding under Article 13.11 and deduct any rental charges that exceed actual or depreciated costs.

- e. Other Items. The District may authorize other items which may be required on the extra work. Such items include labor, services, material, and equipment which are different in their nature from those required by the Work, and which are of a type not ordinarily available from the Contractor or any of the Subcontractors. Invoices covering all such items in detail shall be submitted with the request for payment.
- f. Invoices. Vendors’ invoices for material, equipment rental, and other expenditures shall be submitted with the COR. If the request for payment is not substantiated by invoices or other documentation, the District may establish the cost of the item involved at the lowest price which was current at the time of the Daily Report.
- g. Overhead. Overhead, including direct and indirect costs, shall be submitted with the COR and include: field overhead, home office overhead, off-site supervision, CO preparation/negotiation/research, time delays, Project interference and disruption, additional guaranty and warranty durations, on-site supervision, additional temporary protection, additional temporary utilities, additional material handling costs, liability and property damage insurance, and additional safety equipment costs.

7.7.3 Format for COR or CO’s

The following format shall be used as applicable by the District and the Contractor to communicate proposed additions to the Contract. All costs submitted shall be actual costs and labor shall be unburdened labor. Refer to Division 1 for a copy of the Construction Change Order form.

		<u>EXTRA</u>	<u>CREDIT</u>
(a)	Material (attach itemized quantity and unit cost plus sales tax)	_____	_____
(b)	Labor Not to Exceed Applicable Prevailing Wage Rates (attach itemized hours and rates)	_____	_____
(c)	Equipment (attach invoices)	_____	_____
(d)	Subtotal	_____	_____
(e)	If Subcontractor performed work, add Subcontractor’s overhead and profit to portions performed by Subcontractor, not to exceed 10% of item (d).	_____	_____
(f)	Subtotal	_____	_____

**GENERAL CONDITIONS**

		<u>EXTRA</u>	<u>CREDIT</u>
(g)	Contractor's Overhead and Profit: Not to exceed 10% of Item (d) if Contractor performed the work. No more than 5% of Item (d) if Subcontractor performed the work. If work was performed by Contractor and Subcontractors, portions performed by Contractor shall not exceed 10% of Item (d), and portions performed by Subcontractor shall not exceed 10% of Item (d).		
(h)	Subtotal		
(i)	Bond not to exceed one percent (1%) of Item (h)		
(k)	TOTAL		
(l)	Time/ Days		

The undersigned Contractor approves the foregoing Change Order or Immediate Change Directive as to the changes, if any, and the Contract price specified for each item and as to the extension of time allowed, if any, for completion of the entire Work on account of said Change Order or Immediate Change Directive, and agrees to furnish all labor, materials and service and perform all Work necessary to complete any additional Work specified therein, for the consideration stated herein. It is understood that said Change Order or Immediate Change Directive shall be effective when approved by the Governing Board of the District.

It is expressly understood that the value of such extra Work or changes, as determined by any of the aforementioned methods, expressly includes any and all of the Contractor's costs and expenses, both direct and indirect, resulting from additional time required on the Project or resulting from delay to the Project. Any costs, expenses, damages or time extensions not included are deemed waived.

The Contractor expressly acknowledges and agrees that any change in the Work performed shall not be deemed to constitute a delay or other basis for claiming additional compensation based on theories including, but not limited to, acceleration, suspension or disruption to the Project.

7.7.3.1 *Adjustment for Time and Compensable Delay.* A CO shall also include any additional time required to complete the Project. Any additional time requested shall not be the number of days to make the proposed change, but must be based upon the impact to the Project Schedule as defined in Article 8 of the General Contract. A schedule fragnet showing the time delay must be submitted with the CO. Any changes in time will be granted only if there is an impact to the critical path. If Contractor fails to request a time extension in a CO, then the Contractor is thereafter precluded from requesting or claiming a delay.

7.7.4 Deductive Change Orders



## GENERAL CONDITIONS

All Deductive Change Order(s) must be prepared utilizing the form under Article 7.7.3 (a) – (d) only, setting forth the actual costs incurred. Except in the case of an Article 2.2 or 9.6 Deductive Change Order where no mark-up shall be allowed, Contractor will be allowed a maximum of 5% total profit and overhead.

For unilateral Deductive Change Orders, or where credits are due from Contractor for Allowances, Deductive Items, Inspection, Damage, DSA CCD review costs, Architect or Inspector costs for after hours or corrective services, Work removed from the Agreement under Article 2.2 or Article 9.6, there shall be no mark-up.

District may, any time after a Deductive Change Order is presented to Contractor by District for items under Article 2.2 or Article 9.6 or if there is disagreement as to the Deductive Change Order, issue a unilateral Deductive Change Order on the Project and deduct the Deductive Change Order from a Progress Payment, Final Payment, or Retention.

### 7.7.5 Discounts, Rebates, and Refunds

For purposes of determining the cost, if any, of any change, addition, or omission to the Work hereunder, all trade discounts, rebates, refunds, and all returns from the sale of surplus materials and equipment shall accrue and be credited to the Contractor, and the Contractor shall make provisions so that such discounts, rebates, refunds, and returns may be secured, and the amount thereof shall be allowed as a reduction of the Contractor's cost in determining the actual cost of construction for purposes of any change, addition, or omissions in the Work as provided herein. All CO's are subject to Audit under Article 13.11 for discounts, rebates and refunds.

### 7.7.6 Accounting Records

With respect to portions of the Work performed by CO's and CCD's on a time-and-materials, unit-cost, or similar basis, the Contractor shall keep and maintain cost-accounting records in a format consistent with accepted accounting standards and satisfactory to the District, which shall be available to the District on the same terms as any other books and records the Contractor is required to maintain under the Contract Documents.

Any time and material charges shall require Inspector's signature on time and material cards showing the hours worked and the Work actually completed. (See Article 7.7.1.1)

### 7.7.7 Notice Required

If the Contractor desires to initiate a Dispute for an increase in the Contract Price, or any extension in the Contract Time for completion, Contractor shall notify the applicable party responsible for addressing the Dispute or Claim pursuant to Article 4.6. No Claim or Dispute shall be considered unless made in accordance with this subparagraph. Contractor shall proceed to execute the Work even though the adjustment may not have been agreed upon. Any change in the Contract Price or extension of the Contract Time resulting from such Claim shall be authorized by a CO.

### 7.7.8 Applicability to Subcontractors

Any requirements under this Article 7 shall be equally applicable to CO's, COR's or ICD's issued to Subcontractors by the Contractor to the same extent required by the Contractor.

## **GENERAL CONDITIONS**

### 7.7.9 Alteration to Change Order Language

Contractor shall not alter or reserve time in COR's, CO's or WD's. Contractor shall execute finalized CO's and proceed under Article 7.7.7 and Article 4.6 with proper notice. If Contractor intends to reserve time without an approved CPM schedule prepared pursuant to Article 8 or without submitting a fragnet showing delay to critical path, then Contractor may be prosecuted pursuant to the False Claim Act.

## **GENERAL CONDITIONS**

### **ARTICLE 8 TIME AND SCHEDULE**

#### **8.1 DEFINITIONS**

##### **8.1.1 Contract Time**

Contractor shall perform and reach Substantial Completion (See Article 1.1.46) within the time specified in the Agreement Form. Moreover, Contractor shall perform its Work in strict accordance with the Project Milestones in the Contract Documents and shall proceed on a properly developed and approved Baseline Schedule, which represents the Contractor's view of the practical way in which the Work will be accomplished. Note that Contract Time includes and incorporates all Float and other Baseline inclusions as noted in Article 8.3.2.1 and as otherwise specifically noted in Article 8.

##### **8.1.2 Notice to Proceed**

District may give a Notice to Proceed within ninety (90) days of the award of the bid by District. Once Contractor has received the notice to proceed, Contractor shall complete the Work in the period of time referenced in the Contract Documents.

In the event that District desires to postpone the giving of the Notice to Proceed beyond this three-month period, it is expressly understood that with reasonable notice to the Contractor, the giving of the date to proceed may be postponed by District. It is further expressly understood by Contractor, that Contractor shall not be entitled to any claim of additional compensation as a result of the postponement of the giving of the notice to proceed

If the Contractor believes that a postponement will cause a hardship to Contractor, Contractor may terminate the Contract with written notice to District within 10 days after receipt by Contractor of District's notice of postponement. It is further understood by Contractor that in the event that Contractor terminates the Contract as a result of postponement by the District, the District shall only be obligated to pay Contractor for the Work that Contractor had performed at the time of notification of postponement and the grounds for notification and hardship shall be subject to Audit pursuant to Article 13.11. Should Contractor terminate the Contract as a result of a notice of postponement, District may award the Contract to the next lowest responsible bidder.

##### **8.1.3 Computation of Time**

The term "day" as used in the Contract Documents shall mean calendar day unless otherwise specifically defined.

##### **8.1.4 Float**

Float is time the total number of days an activity may be extended or delayed without delaying the Completion Date shown in the schedule. Float will fall into three categories: (1) Rain Days; (2) Governmental Delays; and, (3) Project Float. Project Float and Rain Days are owned by the Project and may be utilized as necessary for critical path delays once the days become available for consumption (i.e. the Rain Day arrives and is not utilized since rain did not occur or Work was performed on the interior of a building). However, Governmental Delay float shall not be utilized for purposes other than to address critical path delays that arise due to approvals, Inspector approvals or verifications on governmental forms.

## **GENERAL CONDITIONS**

8.1.4.1 *Governmental Delay Float.* It is anticipated that there will be governmental generated delays. Specific to DSA approvals, it is anticipated that no less than twelve (12) days per calendar year shall be set aside as Governmental Float to be utilized on critical path delays. A pro-rated number of days shall be calculated based on length of Contract Time. (For example, a two (2) year Contract Time shall require twenty-four (24) days of Governmental Float. If the Contract Time is 182 days, then the Contract Time shall require six (6) days of Governmental Float) This Governmental Delay float must be incorporated into the schedule and should be incorporated in each critical activity as Contractor deems fit. Specifically, major categories of Work under the DSA 152 (Project Inspection Card) should be allocated Governmental Delay Float at the Contractor's discretion. Governmental Delay Float on the Project may exceed 12 days per one (1) year period, but Contractor is required to include not be less than 12 days of Governmental Delay Float during each one (1) year period.

Contractor's failure to establish a protocol for requesting inspections is not grounds to utilize Governmental Delay Float. As noted in Article 3.1.4, 48 hours advance notice of commencing Work on a new area is required after submitting form DSA 156 and under PR 13-01 Special Inspection reports are not required to be posted until at least 14 days after the Work was inspected. Failure to plan, and pay (if applicable) for quicker delivery of Special Inspections is not Governmental Delay Float under Article 8.1.4.1. If Governmental Delay Float is not utilized, this float is carried through to other DSA 152 categories of inspection and consumed over the course of the Project

Governmental Delay Float may be utilized for a DSA Stop Work Order regardless of fault as defined under Education Code section 17307.5(b).

8.1.4.2 *Inclement Weather (Rain Days).* The Contractor will only be allowed a time extension for unusually severe weather if it results in precipitation or other conditions which in the amount, frequency, or duration is in excess of the norm at the location and time of year in question as established by NOAA weather data. No less than 22 calendar days for each calendar year for Southern California will be allotted for in the Contractor's schedule for each winter weather period or carried at the end of the schedule as Rain Float. Float for weather days in other geographical regions shall be adjusted based on NOAA weather data for the geographical location. Contractor has anticipated all the days it takes to dry out and re-prepare areas that may be affected by weather delays which extend beyond the actual weather days. The weather days shall be shown on the schedule and if not used will become float for the Project's use. The Contractor will not be allowed a day-for-day weather delay for periods noted as float in the Schedule. The Contractor is expected to work seven (7) days per week (if necessary, irrespective of inclement weather), to maintain access, and to protect the Work under construction from the effects of inclement weather. Additional days beyond the NOAA shall be considered under the same criteria that weather days are granted below.

A Rain Day shall be granted by Architect or CM if the weather prevents the Contractor from beginning Work at the usual daily starting time, or prevents the Contractor from proceeding with seventy-five (75%) of the normal labor and equipment force towards completion of the day's current controlling item on the accepted schedule for a period of at least five hours, and the crew is dismissed as a result thereof, the Architect will designate such time as unavoidable delay and grant one (1) critical path activity calendar-day extension if there is no available float for the calendar year.

8.1.4.3 *Project Float.* The Contractor may determine some activities require a lesser duration than allocated and may set aside float in the Project Schedule. There shall be no early completion. Instead, to the extent float is either addressed at the end of the Project or throughout each category of critical path work, Project float may be used as necessary during the course of the Project and allocated on a first,

## **GENERAL CONDITIONS**

come first serve basis. However, the use of float does not extend to Governmental Delay Float, which shall only be used for Governmental Delays.

### **8.2 HOURS OF WORK**

#### **8.2.1 Sufficient Forces**

Contractors and Subcontractors shall continuously furnish sufficient forces to ensure the prosecution of the Work in accordance with the Construction Schedule.

#### **8.2.2 Performance During Working Hours**

Work shall be performed during regular working hours as permitted by the appropriate governmental agency except that in the event of an emergency, or when required to complete the Work in accordance with job progress, Work may be performed outside of regular working hours with the advance written consent of the District and approval of any required governmental agencies.

#### **8.2.3 Costs for After Hours Inspections**

If the Work done after hours is required by the Contract Documents, a Recovery Schedule, or as a result of the Contractor's failure to plan, and inspection must be conducted outside the Inspector's regular working hours, the costs of any after hour inspections, shall be borne by the Contractor.

If the District allows the Contractor to do Work outside regular working hours for the Contractor's convenience, the costs of any inspections required outside regular working hours shall be invoiced to the Contractor by the District and a Deductive Change Order shall be issued from the next Progress Payment.

If the Contractor elects to perform Work outside the Inspector's regular working hours, costs of any inspections required outside regular working hours shall be invoiced to the Contractor by the District and a Deductive Change Order from the next Progress Payment as a Deductive Change Order.

### **8.3 PROGRESS AND COMPLETION**

#### **8.3.1 Time of the Essence**

Time limits stated in the Contract Documents are of the essence to the Contract. By executing the Agreement, the Contractor confirms that the Contract Time is a reasonable period for performing the Work.

#### **8.3.2 Baseline Schedule Requirements**

8.3.2.1 *Timing:* Within ten (10) calendar days after Notice to Proceed, Contractor shall submit a practical schedule showing the order in which the Contractor proposes to perform the Work, and the dates on which the Contractor contemplates starting and completing the salient categories of the Work. This first schedule which outlines the Contractor's view of the practical way in which the Work will be accomplished is the Baseline Schedule. If the Contractor Fails to submit the Baseline Schedule within the ten (10) days noted, then District may withhold processing and approval of progress payments pursuant to Article 9.4 and 9.6.

## **GENERAL CONDITIONS**

8.3.2.2 *District Review and Approval:* District, Architect and CM will review both a paper and electronic copy of Baseline Schedule and may provide comments as noted in this Article and either approve or disapprove the Baseline Schedule. All Schedules shall be prepared using an electronic scheduling program acceptable to District. All Schedules shall be delivered in an electronic format usable by the District. All logic ties and electronic information shall be included in the electronic copy of the Baseline Schedule that is delivered to the District.

8.3.2.3 *Schedule Must Be Within the Given Contract Time.* The Baseline Schedule shall not exceed time limits set forth in the Contract Documents and shall comply with all of the scheduling requirements as set forth in the Specifications and Contract Documents.

8.3.2.4 *Submittals Must Be Incorporated (See Articles 3.7 and 3.9):* Contractor shall include Submittals as line items in the Baseline Schedule as required under Article 3.7.2 and 3.9.6. Submittals shall not delay the Work, Milestones, or the Completion Date. Failure to include Submittals in the Baseline Schedule shall be deemed a material breach by the Contractor.

8.3.2.5 *Float Must Be Incorporated.* The Baseline Schedule must indicate the beginning and completion of all phases of construction and shall use the “critical path method” (commonly called CPM) for the value reporting, planning and scheduling, of all Work required under the Contract Documents. The Baseline Schedule must incorporate all Milestones in the Project and apply Governmental Float at each Milestone in the Contractor’s discretion. The Baseline Schedule shall incorporate any Schedule provided by the District as part of the bid and shall note durations that will not be adequate or should be shortened based on Contractor’s review. These changes shall be identified and incorporated into Contractor’s Baseline Schedule as long as requested changes are made within 10 days after the District chooses to move forward with the Project. Scheduling is necessary for the District’s adequate monitoring of the progress of the Work and shall be prepared in accordance with the time frame described in this Article 8. The Architect may disapprove of any Schedule or require modification to it if, in the opinion of the Architect or District, adherence to the any Schedule prepared by the Contractor will not cause the Work to be completed in accordance with the Agreement.

8.3.2.6 *No Early Completion.* Contractor shall not submit any Schedule showing early completion without indicating float time through the date set for Project completion by District. Contractor’s Baseline Schedule shall account for all days past early completion as float which belongs to the Project. Usage of float shall not entitle Contractor to any delay Claim or damages due to delay.

8.3.2.7 *Use of Schedule Provided in Bid Documents.* In some cases, the bid will include a preliminary schedule indicating Milestones and construction sequences for the Project along with general timing for the Project. The preliminary schedule is not intended to serve as the Baseline Schedule utilized for construction. It is up to the Contractor to study and develop a Baseline Schedule to address the actual durations and sequences of Work that is anticipated while maintaining the Milestones provided by the District. Contract shall obtain information from Contractor’s Subcontractors and vendors on the planning, progress, delivery of equipment, coordination, and timing of availability of Subcontractors so a practical plan of Work is fully developed and represented in the Baseline Schedule.

8.3.2.8 *Incorrect Logic, Durations, Sequences, or Critical Path.* The District may reject or indicate durations, sequences, critical path or logic are not acceptable and request changes. The electronic copy of the Baseline Schedule shall have adequate information so logic ties, duration, sequences and critical path may be reviewed electronically. Contractor is to diligently rebuild and resubmit the Baseline Schedule to represent the Contractor’s plan to complete the Work and maintain Milestones at the next progress meeting, or before the next progress meeting. If Contractor is not able to build a Baseline

## GENERAL CONDITIONS

Schedule that is acceptable to the District or Architect, the District reserves the right to utilize the unapproved originally submitted Baseline Schedule (See Article 8.3.2.12) and the comments submitted to hold Contractor accountable for timely delivery of Work and maintenance of Milestones. Furthermore, Contractor's representations in the Baseline Schedule, if unacceptable, may also be used as a basis for termination of the Contract under Article 14 if Contractor fails to adequately maintain the Schedule and falls significantly behind without undertaking the efforts to either submit and follow a Recovery Schedule or fail to submit a Recovery Schedule and make no effort toward recovery on the Project.

8.3.2.9 *Contractor Responsibility Even if Schedule Issues Are Not Discovered.* Failure on the Part of the District to discover errors or omissions in any Schedules submitted shall not be construed to be an approval of the error or omission and any flawed Schedule is not grounds for a time extension.

8.3.2.9 Inclusions in Baseline Schedule. In addition to scheduling requirements set forth at Article 8.3.2, Contractor is specifically directed to include (broken out separately) in Contractor's Baseline Schedule and all Schedule updates, the following items required pursuant to these General Conditions, including but not limited to:

1. Rain Day Float (excluding inclement weather) as required under Article 8.1.4.2. For example, if the NOAA provides 22 days of Rain Days, all 22 days must be incorporated and noted in the Baseline Schedule. Further, any days required to clean-up or dry out shall be included for operations that are likely to require a clean-up or dry out period. Days that are not utilized shall be considered float owned by the Project.
2. Governmental Delay Float under Article 8.1.4.1. This Governmental Delay Float shall only be utilized for Governmental Delays and shall not be considered available float owned by the Project. This float shall only be distributed to the Project upon the completion of the Project and shall be used to offset Liquidated Damages and shall not generate compensable delays.
3. Submittal and Shop Drawing schedule under Article 3.9.
4. Deferred Approvals under Article 3.9.
5. Time for separate contractors, including furniture installation and start up activities, under Article 6.1.
6. Coordination and timing of any Drawings, approvals, notifications, permitting, connection, and testing for all utilities for the Project. (See Article 2.1.4).
7. Testing, special events, or school activities

8.3.2.10 *Failure to include Mandatory Schedule Items.* District may withhold payment pursuant to Articles 9.3, 9.4 and 9.6. In lieu of withholding payment for failure to include Mandatory Schedule Items, after the District or Architect has notified the Contractor of failure to meet the Baseline Schedule or Updated Schedule requirements and provided a written notification of this failure and provided a written notice of Schedule preparation errors, and the Contractor fails to correct the noted deficiencies or

## GENERAL CONDITIONS

the Contractor does not provide an updated Baseline Schedule correcting the deficiencies, then Contractor shall not be granted an extension of time for failure to obtain necessary items and approvals under Article 8.3.2 and for the time required for failure to comply with laws, building codes, and other regulations (including Title 24 of the California Code of Regulations). Contractor shall maintain all required Article 8.3.2 Schedule items in the Baseline Schedule and indicate any days that have been used as allowed in Article 8. If Contractor fails to include all Article 8.3.2 items in its Baseline Schedule or Schedule Updates and the District either utilizes an Unapproved Schedule under Article 8.3.2.12 or does not object to the inclusion of required scheduling items, then all mandatory Schedule inclusions, including float, shall be utilized in the District's discretion. If the Contract Time is exceeded, then Contractor shall be subject to the assessment of Liquidated Damages pursuant to Article 8.4.

8.3.2.11 *Failure to Meet Requirements.* Failure of the Contractor to provide proper Schedules as required by this Article and Article 9 is a material breach of the Contract and grounds for Termination pursuant to Article 14. The District, at its sole discretion, may choose, instead, to withhold, in whole or in part, any Progress Payments or Retention amounts otherwise payable to the Contractor.

8.3.2.12 *Use of an Unapproved Baseline Schedule.* If the Baseline Schedule submitted by the Contractor is unacceptable to the District (i.e. failing to meet the requirements of Article 8.3.2) and Contractor does not incorporate or address the written comments to the Baseline Schedule and a Baseline Schedule is not approved, but due to extreme necessity, the District moves forward without an approved Baseline Schedule, Contractor shall diligently revise and meet Schedule update requirements of Article 8 and incorporate all Article 8.3.2 comments in all updates). However, for purposes of Termination pursuant to Article 14, the unapproved Baseline Schedule initially submitted shall be treated as the Baseline Schedule with durations shortened or revised to accommodate all float, all mandatory Schedule requirements under Article 8.3.2, any requirements in the Contract Documents, and all revisions by the District or Architect.

### 8.3.3 Update Schedules

8.3.3.1 *Updates Shall Be Based on Approved Baseline Schedule.* Except in the case where there has not been agreement as to a Baseline Schedule, the approved Baseline Schedule shall be used to build future Schedule updates. Schedule updates shall be a CPM based Schedule consistent with the Baseline Schedule requirements of 8.3.2

In the case that no Baseline has been approved, Schedule updates shall be provided monthly and each update shall incorporate all comments and revisions noted as not complying with the requirements of Article 8.3.2. Contractor shall be held to the Article 8.3.2.12 unapproved Baseline Schedule, inclusive of all Milestones, float, comments and revisions by the District and Architect, all required Baseline Schedule Inclusions under Article 8.3.2, and any requirements in the Contract Documents.

8.3.3.2 *Schedule Updates.* Contractor shall update the approved Schedule each month to address actual start dates and durations, the percent complete on activities, actual completion dates, estimated remaining duration for the Work in progress, estimated start dates for Work scheduled to start at future times and changes in duration of Work items

8.3.3.3 *Listing of Items Causing Delays.* Schedule updates shall provide a listing of activities which are causing delay in the progress of Work and a narrative shall be provided showing a description of problem areas, anticipated delays, and impacts on the Construction Schedule. Simply stating "District Delay" or "Architect Delay" shall be an inadequate listing. Delays shall only be listed if they meet the requirements of Article 8.4.



## **GENERAL CONDITIONS**

8.3.3.4 *Recovery Schedule*. In addition to providing a schedule update every thirty (30) days, the Contractor, if requested by the Architect or District, shall take the steps necessary to improve Contractor's progress and demonstrate to the District and Architect that the Contractor has seriously considered how the lost time, the Completion Date, or the Milestones that are required to be met within the terms of the Contract. Contractor shall immediately provide a Recovery Schedule showing how Milestones and the Completion Date will be met. In no case, shall a Recovery Schedule be provided later than ten (10) days following the request for a Recovery Schedule from the Architect or District.

- a. Failure to Provide a Recovery Schedule. Shall subject Contractor to the assessment of Liquidated Damages for failure to meet the Contract Time. Refusal or failure to provide a Recovery Schedule shall be considered a substantial failure of performance and a material breach of Contract and may result in Termination of the Contract pursuant to Article 14.
- b. Recovery Schedule Acceleration without Additional Cost. The District may require Contractor prepare a Recovery Schedule showing how the Project shall be accelerated, without any additional cost to the District. The District may order, without additional cost, the following:
  1. Increase the number of shifts;
  2. Utilize overtime to recover the approved Schedule; and/or
  3. Increase the days when Work occurs, including weekends, at the Project and at any manufacturer's plant.
- c. Recovery Schedule Acceleration without Additional Cost. If Contractor disputes that the Recovery Schedule acceleration shall be issued without additional costs, the Contractor shall submit concurrent with Recovery Schedule acceleration notice pursuant to Articles 8.4.3 and 8.4.4.

## 8.4 **EXTENSIONS OF TIME - LIQUIDATED DAMAGES**

### 8.4.1 Liquidated Damages

CONTRACTOR AND DISTRICT HEREBY AGREE THAT THE EXACT AMOUNT OF DAMAGES FOR FAILURE TO COMPLETE THE WORK WITHIN THE TIME SPECIFIED IS EXTREMELY DIFFICULT OR IMPOSSIBLE TO DETERMINE. IF THE WORK IS NOT SUBSTANTIALLY COMPLETED IN THE TIME SET FORTH IN THE AGREEMENT, IT IS UNDERSTOOD THAT THE DISTRICT WILL SUFFER DAMAGES. IT BEING IMPRACTICAL AND UNFEASIBLE TO DETERMINE THE AMOUNT OF ACTUAL DAMAGE, IT IS AGREED THE CONTRACTOR SHALL PAY TO THE DISTRICT THE AMOUNT LIQUIDATED DAMAGES SET FORTH IN THE AGREEMENT, FOR EACH CALENDAR DAY OF DELAY IN REACHING SUBSTANTIAL COMPLETION (SEE ARTICLE 1.1.46). CONTRACTOR AND ITS SURETY SHALL BE LIABLE FOR THE AMOUNT THEREOF PURSUANT TO GOVERNMENT CODE SECTION 53069.85.

### 8.4.2 Delay

## GENERAL CONDITIONS

Except and only to the extent provided under Article 7 and Article 8, by signing the Agreement, Contractor agrees to bear the risk of delays to Completion of the Work and that Contractor's bid for the Project was made with full knowledge of this risk.

In agreeing to bear the risk of delays to complete the Work, Contractor understands that, except and only to the extent provided otherwise in Article 7 and 8, the occurrence of events that delay the Work shall not excuse Contractor from its obligation to achieve Completion of the Project within the Contract Time, and shall not entitle the Contractor to an adjustment to the Contract time.

### 8.4.3 Excusable Delay

Contractor shall not be charged for Liquidated Damages because of any delays in completion of Work which are not the fault or negligence of Contractor or its Subcontractors, arising from Rain Float or Project Float, including acts of God, as defined in Public Contract Code section 7105, acts of enemy, epidemics and quarantine restrictions. Contractor shall within five (5) calendar days of beginning of any such delay notify District in writing of causes of delay; thereupon District shall ascertain the facts and extent of delay and grant extension of time for completing Work when, in its judgment, the findings of fact justify such an extension. Extensions of time shall apply only to that portion of Work affected by delay, and shall not apply to other portions of Work not so affected. An extension of time may only be granted after proper compliance with Article 8.3 requiring preparation and submission of a properly prepared CPM schedule.

8.4.3.1 *Excusable Delay Is Not Compensable.* No extended overhead, general conditions costs, impact costs, out-of-sequence costs or any other type of compensation, by any name or characterization, shall be paid to the Contractor for any delay to any activity not designated as a critical path item on the latest approved Project schedule.

8.4.3.2 *Notification.* The Contractor shall notify the Architect in writing of any anticipated delay and its cause, in order that the Architect may take immediate steps to prevent, if possible, the occurrence or continuance of delay, and may determine whether the delay is to be considered avoidable or unavoidable, how long it continues, and to what extent the prosecution and completion of the Work might be delayed thereby.

8.4.3.3 *Extension Request.* In the event the Contractor requests an extension of Contract time for unavoidable delay, such request shall be submitted in accordance with the provisions in the Contract Documents governing changes in Work (See Article 7). When requesting time, i.e., extensions, for proposed Change Orders, they must be submitted with the proposed Change Order with full justification and documentation. If the Contractor fails to submit justification with the proposed Change Order it waives its right to a time extension at a later date. Such justification must be based on the official Contract schedule as updated at the time of occurrence of the delay or execution of Work related to any changes to the scope of Work. Blanket or general claims for extra days without specific detailed information as required herein or a blanket or general reservation of rights do not fulfill the requirements of this Article and shall be denied. The justification must include, but is not limited to, the following information:

- a. The duration of the activity relating to the changes in the Work and the resources (manpower, equipment, material, etc.) required to perform these activities within the stated duration.
- b. Logical ties to the official Baseline Schedule or Approved Updated Schedule for the proposed changes and/or delay showing the activity/activities in the schedule

## GENERAL CONDITIONS

whose start or completion dates are affected by the change and/or delay. (A fragnet of any delay of over ten (10) days must be provided.)

The Contractor and District understand and expressly agree that insofar as Public Contract Code section 7102 may apply to changes in the Work or delays under this Contract, the actual delays and damages, if any, and time extensions are intended to, and shall provide, the exclusive and full method of compensation for changes in the Work and construction delays.

### 8.4.4 Notice by Contractor Required

The Contractor shall within five (5) calendar days of beginning of any such delay notify the District in writing of causes of delay with justification and supporting documentation. In the case of a Recovery Schedule pursuant to Article 8.3.3.4, Contractor shall submit written notice concurrent with the Recovery Schedule. District will then ascertain the facts and extent of the delay and grant an extension of time for completing the Work when, in its judgment, the findings of fact justify such an extension. Extensions of time shall apply only to that portion of the Work affected by the delay and shall not apply to other portions of the Work not so affected.

Claims relating to time extensions shall be made in accordance with applicable provisions of Article 7.

8.4.4.1 *Adjustment for Compensable Delays.* The Schedule may be adjusted for a delay if, and only if, Contractor undertakes the following:

- a. Contractor submits a timely COR or CO pursuant to the requirements of Article 7.
- b. Contractor submits a fragnet showing the critical path delay caused by the COR, CO, Changed Condition, CCD, or WD
- c. Contractor has addressed all required float days in the Fragnet.
- d. Contractor submits a complete breakdown of all costs incurred utilizing the format of Article 7.3.3

### 8.4.5 No Additional Compensation for Coordinating Governmental Submittals and the Resulting Work

CONTRACTOR HAS PLANNED ITS WORK AHEAD OF TIME AND IS AWARE THAT GOVERNMENTAL AGENCIES, SUCH AS THE GAS COMPANIES, ELECTRICAL UTILITY COMPANIES, WATER DISTRICTS AND OTHER AGENCIES MAY HAVE TO APPROVE CONTRACTOR PREPARED DRAWINGS OR APPROVE A PROPOSED INSTALLATION. CONTRACTOR HAS INCLUDED DELAYS AND DAMAGES WHICH MAY BE CAUSED BY SUCH AGENCIES IN CONTRACTOR'S BID AND HAS INCLUDED ADEQUATE TIME IN THE CONTRACTOR'S BASELINE SCHEDULE. FAILURE TO ADEQUATELY PLAN AND SCHEDULE IS NOT A BASIS TO USE GOVERNMENTAL DELAY FLOAT.

### 8.4.6 District Right to Accelerate the Work

## **GENERAL CONDITIONS**

The District may direct the Contractor to meet schedule requirements when the Work has been delayed. The District shall compensate the Contractor for the additional costs incurred by acceleration to the extent that such costs are directly attributable to the acceleration and are incurred through no fault or negligence of the Contractor.

8.4.6.1 *Management of Acceleration.* Contractor acceleration shall not include Work that is part of the scope of Work detailed in the Plans and Specifications. Instead, the acceleration costs shall be premium or overtime and quantifiable additional work added to the Project meant to accelerate the Project. Contractor is directed to keep consistent crews on the Project so time can be tracked. If crews are circulated off the Project or crews brought in only for overtime, the District may be charged for Contract Work and not accelerated time. In such case, the District may object to the costs submitted.

8.4.6.2 *Costs for Acceleration.* Cost for Acceleration shall be supported by backup documentation, and time sheets signed by the Inspector for each day work has been performed, at or near the time when the Work was performed. A listing on the time sheet shall document all labor, materials and services utilized that day and provide areas of work, and amount of work performed. Contractor shall comply with submission requirements of Article 7.7.

## **GENERAL CONDITIONS**

### **ARTICLE 9 PAYMENTS AND COMPLETION**

#### **9.1 CONTRACT SUM**

The Contract Sum or Contract Price is stated in the Agreement and, including authorized adjustments, is the total amount payable by the District to the Contractor for performance of the Work under the Contract Documents.

#### **9.2 COST BREAKDOWN**

##### **9.2.1 Required Information**

Contractor shall furnish the following:

- a. Within ten (10) days after Notice to Proceed, a detailed breakdown of the Contract Price (hereinafter "Schedule of Values") for each Project, Site, building, Milestone or other meaningful method to measure the level of Project Completion as determined by the District shall be submitted as a Submittal for the Project.;
- b. Within ten (10) days after the date of the Notice to Proceed, a schedule of estimated monthly payment requests due the Contractor showing the values and construction time of the various portions of the Work to be performed by it and by its Subcontractors or material and equipment suppliers containing such supporting evidence as to its correctness as the District may require;
- c. Within ten (10) days after the date of the Notice to Proceed, address, telephone number, telecopier number, California State Contractors License number, classification and monetary value of all subcontracts for parties furnishing labor, material, or equipment for completion of the Project.

##### **9.2.2 Information and Preparation of Schedule of Values**

9.2.2.1 *Break Down of Schedule of Values.* Schedule of Values shall be broken down by Project, site, building, Milestone, or other meaningful method to measure the level of Project Completion as determined by the District.

9.2.2.2 *Based on Contractor Bid Costs.* The Schedule of Values shall be based on the costs from Contractor's bid to the District. However, the submission of the Schedule of Values shall not be front loaded so the Contractor is paid a greater value than the value of the Work actually performed and shall not shift funds from parts of the Project that are later to Work that is performed earlier.

9.2.2.3 Largest Dollar Value for Each Line Item. Identify Subcontractors and materials suppliers proposed to provide portions of Work equal to or greater than ten thousand dollars (\$10,000) or one-half of one percent (0.5%) of their Contract Price, whichever is less.

9.2.2.4 *Allowances.* Any Allowances provided for in the Contract shall be a line item in the Schedule of Values.

## **GENERAL CONDITIONS**

9.2.2.5 *Labor and Materials Shall Be Separate.* Labor and Materials shall be broken into two separate line items unless specifically agreed in writing by the District.

### 9.2.3 District Approval Required

The District shall review all submissions received pursuant to Article 9.2 in a timely manner. All submissions must be approved by the District before becoming the basis of any payment.

## 9.3 **PROGRESS PAYMENTS**

### 9.3.1 Payments to Contractor

Unless there is a resolution indicating that the Work for the Project is substantially complex, within thirty-five (35) days after approval of the Request for Payment, Contractor shall be paid a sum equal to ninety-five percent (95%) of the value of the Work performed (as certified by Architect and Inspector and verified by Contractor) up to the last day of the previous month, less the aggregate of previous payments. In the case of a Project designated substantially complex, the sum paid to the Contractor shall be equal to ninety percent (90%) of the value of the Work performed (as certified by the Architect and Inspector and verified by Contractor). The value of the Work completed shall be the Contractor's best estimate. Work completed as estimated shall be an approximation or estimate only and no mistake, inaccuracy, error or falsification in said any approved estimate shall operate to release the Contractor, or any Surety upon any bond, from damages arising from such Work, or from the District's enforcement of each and every provision of this Contract including but not limited to the Performance Bond and Payment Bond. The District shall have the right to subsequently to correct any mistake, inaccuracy, error or falsification made or otherwise set forth in any approved Request for Payment and such correction may occur in any future Payment Application or in the Retention Payment to the Contractor. No Surety upon any bond shall be relieved, released or exonerated of its obligations under this Contract or any applicable bond when the District is unable to correct an overpayment to the Contractor due to any abandonment by the Contractor or termination by the District.

The Contractor shall not be entitled to have any payment requests processed, or be entitled to have any payment made for Work performed, so long as any lawful or proper direction given by the District concerning the Work, or any portion thereof, remains incomplete.

Notwithstanding anything to the contrary stated above, the Contractor may include in its Request for Payment the value of any structural steel, glue laminated beams, trusses, bleachers and other such custom-made materials prepared specifically for the Project and unique to the Project so long as all of the following requirements are satisfied:

- a. The aggregate cost of materials stored off-site shall not exceed Twenty Five Thousand Dollars (\$25,000) at any time or as otherwise agreed to be District in writing;
- b. Title to such materials shall be vested in the District as evidenced by documentation satisfactory in form and substance to the District, including, without limitation, recorded financing statements, UCC filings and UCC searches;
- c. With each Contractor Request for Payment, the Contractor shall submit to the District a written list identifying each location where materials are stored off-site (which must be a bonded warehouse) and the value of the materials at each

## GENERAL CONDITIONS

location. The Contractor shall procure insurance satisfactory to the District (in its reasonable discretion) for materials stored off-site in an amount not less than the total value thereof;

- d. The consent of any Surety shall be obtained to the extent required prior to payment for any materials stored off-site;
- e. Representatives of the District shall have the right to make inspections of the storage areas at any time; and
- f. Such materials shall be: (1) protected from diversion, destruction, theft and damage to the reasonable satisfaction of the District; (2) specifically marked for use on the Project; and (3) segregated from other materials at the storage facility.

### 9.3.2 Purchase of Materials and Equipment and Cost Fluctuations

The Contractor is required to order, obtain, and store materials and equipment sufficiently in advance of its Work at no additional cost or advance payment from District to assure that there will be no delays. Contractor understands that materials fluctuate in value and shall have adequately addressed market fluctuations through agreements with Contractor vendors or by other means. Contractor further understands and incorporates into Contractor's bid cost any wage rate increases during the Project for the Contractor's labor force as well as all other Subcontractor and vendor labor forces. District shall not be responsible for market fluctuations in costs or labor rate increases during the Project. Contractor further has incorporated any and all cost increases in areas of Work where there may be schedule variations so that cost increases are not passed through to the District.

### 9.3.3 No Waiver

No payment by District hereunder shall be interpreted so as to imply that District has inspected, approved, or accepted any part of the Work. Contractor specifically understands that Title 24 Section 4-343 which states:

“It is the duty of the contractor to complete the work covered by his or her contract in accordance with the approved Plans and Specifications therefore. The contractor in no way is relieved of any responsibility by the activities of the Architect, Engineer, Inspector or DSA in the performance of such duties... In no case, however, shall the instruction of the Architect or registered Engineer be construed to cause work to be done with is not in conformity with the approved Plans, Specifications, and change orders...”

Notwithstanding any payment, the District may enforce each and every provision of this Contract which includes, but is not limited to, the Performance Bond and Payment Bond. The District may correct any error subsequent to any payment. In no event shall the Contractor or the Surety be released or exonerated from performance under this Contract when the District overpays the Contractor based upon any mistake, inaccuracy, error or falsification in any estimate that is included in any Request for Payment.

### 9.3.4 Issuance of Certificate of Payment

The Architect shall, within seven (7) days after receipt of the Contractor's Application for Payment, either approve such payment or notify the Contractor in writing of the Architect's reasons for

## **GENERAL CONDITIONS**

withholding approval in whole or in part as provided in Article 9.6. The review of the Contractor's Application for Payment by the Architect is based on the Architect's observations at the Project and the data comprising the Application for Payment that the Work has progressed to the point indicated and that, to the best of the Architect's knowledge, information, and belief, the quality of the Work is in accordance with the Contract Documents. In some cases, the Architect may act upon or rely on the evaluation of the Work by the Inspector. This review of Payment Applications is sometimes called a "Pencil Draft." District's return of a Pencil Draft shall constitute the District's dispute of the Payment Application that has been submitted. Contractor shall promptly respond to Pencil Drafts or Contractor's Payment Applications may be delayed. Contractor's failure to promptly respond to a Pencil Draft shall qualify as a delay in the prompt payment of a Request for Payment or Request for Retention. The foregoing representations are subject to: (1) an evaluation of the Work for conformance with the Contract Documents, (2) results of subsequent tests and inspections, (3) minor deviations from the Contract Documents correctable prior to completion, and (4) specific qualifications expressed by the Architect. The issuance of a Certificate for Payment will further constitute the Contractor's verified representation that the Contractor is entitled to payment in the amount certified.

### **9.3.5 Payment of Undisputed Contract Payments**

In accordance with Public Contract Code section 7100, payments by the District to the Contractor for any and all undisputed amounts (including all Progress Payments, Final Payments or Retention Payment) is contingent upon submission of a proper and accurate Payment Application and the Contractor furnishing the District with a release of all Claims against the District related to such undisputed amounts. Disputed Contract Claims in stated amounts may be specifically excluded by the Contractor from the operation of the release. If, however, the Contractor specifically excludes any Claims, the Contractor shall provide details such as a specific number of disputed days or costs of any such exclusion in accordance with Articles 4.6 and 7.7.

## **9.4 APPLICATIONS FOR PROGRESS PAYMENTS**

### **9.4.1 Procedure**

9.4.1.1 *Application for Progress.* On or before the fifth (5th) day of each calendar month during the progress of the Work, Contractor shall submit to the Architect an itemized Application for Progress Payment for operations completed. Such application shall be notarized, if required, and supported by the following or such portion thereof as Architect requires:

1. The amount paid to the date of the Payment Application to the Contractor, to all its Subcontractors, and all others furnishing labor, material, or equipment for its Contract;
2. The amount being requested under the Payment Application by the Contractor on its own behalf and separately stating the amount requested on behalf of each of the Subcontractors and all others furnishing labor, material, and equipment under the Contract;
3. The balance that will be due to each of such entities after said payment is made;
4. A certification that the As-Built Drawings and Annotated Specifications are current;



## GENERAL CONDITIONS

5. Itemized breakdown of Work done for the purpose of requesting partial payment;
6. An updated or approved Baseline Schedule or other Schedule updates in conformance with Article 8;
7. Failure to submit an updated Schedule for the month or any previous month;
8. The additions to and subtractions from the Contract Price and Contract Time;
9. A summary of the Retention held;
10. Material invoices, evidence of equipment purchases, rentals, and other support and details of cost as the District may require from time to time;
11. The percentage of completion of the Contractor's Work by line item;
12. An updated Schedule of Values from the preceding Application for Payment;
13. Prerequisites for Progress Payments; and
14. Any other information or documents reasonably requested by the District, Architect, Inspector or CM (if applicable).

9.4.1.2 *First Payment Request.* The following items, if applicable, must be completed before the first payment request will be accepted for processing:

1. Installation of the Project sign;
2. Receipt by Architect of Submittals;
3. Installation of field office;
4. Installation of temporary facilities and fencing;
5. Submission of documents listed in the Article 9.2 relating to Contract Price breakdown;
6. Preliminary schedule analysis, due within 10 days after Notice to Proceed;
7. Contractor's Baseline Schedule (to be CPM based in conformance with Article 8);
8. Schedule of unit prices, if applicable;
9. Submittal Schedule;
10. Copies of necessary permits;

## **GENERAL CONDITIONS**

11. Copies of authorizations and licenses from governing authorities;
12. Initial progress report;
13. Surveyor qualifications;
14. Written acceptance of District's survey of rough grading, if applicable;
15. List of all Subcontractors, with names, license numbers, telephone numbers, and scope of work;
16. All bonds and insurance endorsements; and
17. Resumes of General Contractor's Project Manager, and if applicable, job site secretary, record documents recorder, and job site Superintendent.

9.4.1.3 *Second Payment Request.* The second payment request will not be processed until all Submittals and Shop Drawings have been accepted for review by the Architect.

9.4.1.4 *All Payment Requests.* No payment requests will be processed unless Contractor has submitted copies of the certified payroll records for the Work which correlates to the payment request and a proper CPM schedule pursuant to Article 8 is submitted.

9.4.1.5 *Final Payment Application (90% or 95%).* See Article 9.11.1

9.4.1.6 *Final Payment Application (100%).* See Article 9.11.3

### 9.5 **STOP NOTICE CLAIMS AND WARRANTY OF TITLE**

The Contractor warrants title to all Work. The Contractor further warrants that all Work is free and clear of liens, claims, security interests, stop notices, or encumbrances in favor of the Contractor, Subcontractors, material and equipment suppliers, or other persons or entities making a claim by reason of having provided labor, materials, and equipment relating to the Work. Failure to keep work free of liens, stop notices, claims, security interests or encumbrances is grounds to make a claim against Contractor's Payment and Performance Bond to immediately remedy and defend.

If a lien or stop notice of any nature should at any time be filed against the Work or any District property, by any entity which has supplied material or services at the request of the Contractor, Contractor and Contractor's Surety shall promptly, on demand by District and at Contractor's and Surety's own expense, take any and all action necessary to cause any such lien or stop notice to be released or discharged immediately therefrom.

If the Contractor fails to furnish to the District within ten (10) calendar days after written demand by the District, satisfactory evidence that a lien or stop notice has been so released, discharged, or secured, then District may discharge such indebtedness and deduct the amount required therefor, together with any and all losses, costs, damages, and attorney's fees and expense incurred or suffered by District from any sum payable to Contractor under the Contract. In addition, any liens, stop notices, claims, security interests or encumbrances shall trigger the indemnification requirements under Article 3.15 and the Agreement Form, and shall act as a trigger under Civil Code section 2778 and 2779 requiring reimbursement for any and all costs following the District's written demand has been made. Any withholdings by the District for

## **GENERAL CONDITIONS**

stop notices in accordance with Civil Code section 9358 shall not be a basis by the Contractor to make a Claim for interest penalties under Public Contract Code sections 7107 or 20104.50.

### **9.6 DECISIONS TO WITHHOLD PAYMENT**

#### **9.6.1 Reasons to Withhold Payment**

The District may withhold payment in whole, or in part, to the extent reasonably necessary to protect the District if, in the District's opinion, the representations to the District required by Article 9.4 cannot be made. The District may withhold payment, in whole, or in part, to such extent as may be necessary to protect the District from loss because of, but not limited to:

- a. Defective Work not remedied;
- b. Stop notices served upon the District;
- c. Liquidated Damages assessed against the Contractor;
- d. The cost of Completion of the Contract if there exists reasonable doubt that the Work can be Completed for the unpaid balance of any Contract Price or by the completion date;
- e. Damage to the District or other contractor;
- f. Unsatisfactory prosecution of the Work by the Contractor;
- g. Failure to store and properly secure materials;
- h. Failure of the Contractor to submit on a timely basis, proper and sufficient documentation required by the Contract Documents, including, without limitation, acceptable monthly progress schedules, Shop Drawings, Submittal schedules, Schedule of Values, Product Data and samples, proposed product lists, executed Change Order, Construction Change Documents, and verified reports;
- i. Failure of the Contractor to maintain As-Built Drawings;
- j. Erroneous estimates by the Contractor of the value of the Work performed, or other false statements in an Payment Application;
- k. Unauthorized deviations from the Contract Documents (including but not limited to Unresolved Notices of Deviations (DSA Form 154));
- l. Failure of the Contractor to prosecute the Work in a timely manner in compliance with established progress schedules and completion dates.
- m. Failure to properly pay prevailing wages as defined in Labor Code section 1720, et seq.;
- n. Failure to properly maintain or clean up the Site;

## **GENERAL CONDITIONS**

- o. Payments to indemnify, defend, or hold harmless the District;
- p. Any payments due to the District including but not limited to payments for failed tests, or utilities changes or permits;
- q. Failure to submit an acceptable Baseline Schedule or any Schedule or Schedule update in accordance with Article 8;
- r. Failure to pay Subcontractor or suppliers as required by Article 9.8.1
- s. Failure to secure warranties, including the cost to pay for warranties;
- t. Failure to provide releases from material suppliers or Subcontractors when requested to do so;
- u. Items deducted pursuant to Article 2.2;
- v. Incomplete Punch List items under Article 9.9.1.1 which have gone through the Article 2.2 process; or
- w. Allowances that have not been used.

### 9.6.2 **Reallocation of Withheld Amounts**

District may, in its discretion, apply any withheld amount to payment of outstanding claims or obligations as defined in Article 9.6.1 and 9.5. In so doing, District shall make such payments on behalf of Contractor. If any payment is so made by District, then such amount shall be considered as a payment made under Contract by District to Contractor and District shall not be liable to Contractor for such payments made in good faith. Such payments may be made without prior judicial determination of claim or obligation. District will render Contractor an accounting of such funds disbursed on behalf of Contractor.

If Contractor defaults or neglects to carry out the Work in accordance with the Contract Documents or fails to perform any provision thereof, District may, after ten (10) calendar days written notice to the Contractor and without prejudice to any other remedy make good such deficiencies. The District shall adjust the total Contract price by reducing the amount thereof by the cost of making good such deficiencies. If District deems it inexpedient to correct Work which is damaged, defective, or not done in accordance with Contract provisions, an equitable reduction in the Contract Price (of at least 150% of the estimated reasonable value of the nonconforming Work) shall be made therefor.

### 9.6.3 **Payment After Cure**

When the grounds for declining approval are removed, payment shall be made for amounts withheld because of them. No interest shall be paid on any retainage or amounts withheld due to the failure of the Contractor to perform in accordance with the terms and conditions of the Contract Documents.

## 9.7 **NONCONFORMING WORK**

Contractor shall promptly remove from premises all Work identified by District as failing to conform to the Contract whether incorporated or not. Contractor shall promptly replace and re-execute its

## **GENERAL CONDITIONS**

own Work to comply with the Contract without additional expense to District and shall bear the expense of making good all Work of other contractors destroyed or damaged by such removal or replacement.

If Contractor does not remove such Work which has been identified by District as failing to conform to the Contract Documents within a reasonable time, fixed by written notice, District may remove it and may store the material at Contractor's expense. If Contractor does not pay expenses of such removal within ten (10) calendar days' time thereafter, District may, upon ten (10) calendar days' written notice, sell such materials at auction or at private sale and shall account for net proceeds thereof, after deducting all costs and expenses that should have been borne by Contractor.

### **9.8 SUBCONTRACTOR PAYMENTS**

#### **9.8.1 Payments to Subcontractors**

No later than ten (10) days after receipt, or pursuant to Business and Professions Code section 7108.5, the Contractor shall pay to each Subcontractor, out of the amount paid to the Contractor on account of such Subcontractor's portion of the Work, the amount to which said Subcontractor is entitled. The Contractor shall, by appropriate agreement with each Subcontractor, require each Subcontractor to make payments to Sub-subcontractors in a similar manner.

#### **9.8.2 No Obligation of District for Subcontractor Payment**

The District shall have no obligation to pay, or to see to the payment of, money to a Subcontractor except as may otherwise be required by law.

#### **9.8.3 Payment Not Constituting Approval or Acceptance**

An approved Request for Payment, a progress payment, a Certificate of Substantial Completion, or partial or entire use or occupancy of the Project by the District shall not constitute acceptance of Work that is not in accordance with the Contract Documents.

#### **9.8.4 Joint Checks**

District shall have the right, if necessary for the protection of the District, to issue joint checks made payable to the Contractor and Subcontractors and material or equipment suppliers. The joint check payees shall be responsible for the allocation and disbursement of funds included as part of any such joint payment. In no event shall any joint check payment be construed to create any contract between the District and a Subcontractor of any tier, any obligation from the District to such Subcontractor, or rights in such Subcontractor against the District. The District may choose to issue joint checks at District's sole discretion and only after all the requirements of that particular school district and county are specifically met. Some school districts cannot issue joint checks, so the ability to issue joint checks depends on the school district and the specific circumstances.

### **9.9 COMPLETION OF THE WORK**

#### **9.9.1 Close-Out Procedures**

9.9.1.1 *Incomplete Punch Items.* When the Contractor considers the Work Substantially Complete (See Article 1.1.46 for definition of Substantially Complete), the Contractor shall prepare and submit to the District a comprehensive list of minor items to be completed or corrected

## GENERAL CONDITIONS

(hereinafter “Incomplete Punch Items” or “Punch List”). The Contractor and/or its Subcontractors shall proceed promptly to complete and correct the Incomplete Punch Items listed. Failure to include an item on such list does not alter the responsibility of the Contractor to complete all Work in accordance with the Contract Documents. Contractor is aware that Title 24 Section 4-343(a) provides:

“RESPONSIBILITIES. IT IS THE DUTY OF THE CONTRACTOR TO COMPLETE THE WORK COVERED BY HIS OR HER CONTRACT IN ACCORDANCE WITH THE APPROVED PLANS AND SPECIFICATIONS THEREFOR. THE CONTRACTOR IN NO WAY IS RELIEVED OF ANY RESPONSIBILITY BY THE ACTIVITIES OF THE ARCHITECT, ENGINEER, INSPECTOR OR DSA IN THE PERFORMANCE OF SUCH DUTIES.

9.9.1.2 *Punch List Is Prepared Only After the Project Is Substantially Complete.* If any of the conditions noted in Article 1.1.46 as defining Substantial Completion are not met, the Inspector, Architect or District may reject Contractor’s Incomplete Punch Items as premature. If the Architect and Inspector commence review of Incomplete Punch Items, all rights are reserved until the Project actually meets the definition of Substantially Complete. Liquidated Damages, warranties, and other contractual rights are not affected by Incomplete Punch Items unless otherwise addressed in these General Conditions.

Once the Inspector and the Architect determine the Project is Substantially Complete, a Certificate of Substantial Completion shall be issued. The Inspector and Architect shall prepare a Punch List of items which is an inspection report of the Work, if any, required in order to complete the Contract Documents and ensure compliance with the DSA Approved Plans so the Project may be Completed by the Contractor and a final DSA Close-Out is approved. When all Work for the Project is Complete, including Punch Lists and all Work complies with the approved Contract Documents and Change Orders, the Project has reached Final Completion.

9.9.1.3 *Time for Completion of Punch List.* Contractor shall only be given a period of no more than thirty (30) days to complete the Punch List for the Project. During the Punch List period, the Contractor’s Superintendent and Project Manager shall remain engaged in the Project and shall not be removed or replaced. If the Punch List is not completed at the end of the Punch List time then Contractor shall issue a valued Punch List within 5 days after the date the Punch List time ends. If Contractor does not issue such a list, the District or Architect may issue a valued Punch List to the Contractor and withhold up to 150% of the value of the Punch List Work pursuant to Article 2.2 of this Agreement.

Failure to issue a timely written request for additional time to complete Punch List shall result in the deletion of the remaining Punch List Work pursuant to Article 2.2 and the issuance of a Deductive Change Order.

- a. Extension of Time to Complete Punch List. If Contractor cannot finish the Punch List Work during the time period allotted under Article 9.9.1.3, the Contractor may make a written request for a Non-Compensable Punch List time extension accompanied by an estimate of the number of additional days it will take to complete the Punch List Work for a written consent from the District to allow continued Punch List Work. Punch List time extensions are a maximum of thirty (30) days for each request and must be accompanied by an itemized valued Punch List.
- b. If there is no valued Punch List accompanying any request or if Contractor intends to undertake Punch List without the continued support and

## GENERAL CONDITIONS

supervision of its Superintendent and Project Manager (as required under Article 3.2), the District, Construction Manager or Architect may issue a valued Punch List, reject the Punch List Time Extension and deduct 150% of the valued Punch List pursuant to Article 2.2 and proceed to Close-Out the Project. Contractor shall cease work on the Project and proceed to complete Contractor's Retention Payment Application and complete the Work for the Project required pursuant to Article 9.11.3.

9.9.1.4 *District Rejection of Written Request for Punch List Time Extensions.* Following sixty (60) Days of Punch List under Article 9.9.1.3, the District has the option of rejecting Punch List Time Extension requests. The District may proceed under Article 2.2 and deduct the value of remaining Punch List Work pursuant to Article 2.2. If the District rejects the Punch List Time Extension request then Contractor shall cease Work on the Project and proceed to Final Inspection pursuant to Article 9.11.2.

9.9.1.5 *Punch List Liquidated Damages to Compensate for Added District Project Costs.* If the total time utilized for Punch List exceeds sixty (60) days [the thirty (30) day period under Article 9.9.1.3 plus an additional thirty (30) day period that has been requested in writing], and the District grants an additional written Punch List Time Extension that exceeds sixty (60) days of Punch List, then Contractor shall be charged Liquidated Damages of at least \$750 per day for continued Punch List Work to partially compensate the Inspector, Architect, and Construction Manager's extended time on the Project. This Punch List Liquidated Damage number is based on anticipated cost for an Inspector on site and additional costs for the Architect and Construction Manager to reinspect Punch List items and perform the administration of the Close-out.

Contractor received thirty (30) days without any charges for Punch List Liquidated Damages and is placed on notice pursuant to this Article 9.9.1.5 that \$750 is due for each day of Punch List that exceeds sixty (60) days at \$750, a cost much lower than typical (and actual) costs for Inspection, Architect and Construction Manager time required during Punch List. Starting at ninety (90) days of Punch List (an excessive number of days to complete Punch List), the District shall be entitled to adjust Punch List Liquidated Damages to an estimate of the actual costs incurred to oversee, monitor and inspect the Punch List. If costs exceed \$750 per day, the anticipated extended contract charges for Inspection, Architect, Construction Manager, and any other costs that will be incurred due to the extended Punch List shall be itemized and a daily rate of Punch List Liquidated Damages shall be presented in writing to the Contractor within five (5) days following the receipt of a written request for Punch List Time Extension by the Contractor that extends the Punch List time beyond ninety (90) days. This written notice of actual Punch List Liquidated Damages may be provided to the Contractor at any time following the first written request for Punch List Time extension requested under Article 9.9.1.3. The adjusted actual Punch List Liquidated Damage amount shall be applicable as Punch List Liquidated Damages commencing on the ninetieth (90<sup>th</sup>) day of Punch List.

### 9.9.2 Close-Out Requirements for Final Completion of the Project

- a. Utility Connections. Buildings shall be connected to water, gas, sewer, and electric services, complete and ready for use. Service connections shall be made and existing services reconnected
- b. As-Built Up to Date and Complete. The intent of this procedure is to obtain an exact "As-Built" record of the Work upon completion of the project. The following information shall be carefully and correctly drawn on the prints and all items shall

## GENERAL CONDITIONS

be accurately located and dimensioned from finished surfaces of building walls on all As-Built Drawings

1. The exact location and elevations of all covered utilities, including valves, cleanouts, etc. must be shown on As-Built Drawings
2. Contractor is liable and responsible for inaccuracies in As-Built Drawings, even though they become evident at some future date.
3. Upon completion of the Work and as a condition precedent to approval of Retention Payment, Contractor shall obtain the Inspector's approval of the "As-Built" information. When completed, Contractor shall deliver corrected sepias and/or a Diskette with an electronic file in a format acceptable to the District.
4. District may withhold the cost to hire a draftsman and potholing and testing service to complete Record As-Built Drawings at substantial cost if the Contractor does not deliver a complete set of Record As-Built Drawings. This shall result in withholding of between \$10,000 to \$20,000 per building that does not have a corresponding Record As Built Drawing.

c. Any Work not installed as originally indicated on Drawings

d. All DSA Close-Out requirements (See DSA Certification Guide) Contractor is also specifically directed to Item 3.2 in the DSA Certification Guide and the applicable certificates for the DSA-311 form.

e. Submission of Form 6-C. Contractor shall be required to execute a Form 6-C as required under Title 24 Sections 4-343. The Contractor understands that the filing with DSA of a Form 6-C is a requirement to obtain final DSA Approval of the construction by Contractor and utilized to verify under penalty of perjury that the Work performed by Contractor complies with the DSA approved Contract Documents. The failure to file a DSA Form 6C has two consequences. First, the Construction of the Project will not comply with the design immunity provisions of Government Code section 830.6 and exposes the District and the individual Board members to personal liability for injuries that occur on the Project.

Secondly , under DSA IR A-20, since the Project cannot be Certified by DSA, no future or further Projects will be authorized so Contractor will have essentially condemned the campus from any future modernization or addition of new classrooms through their failure to file the DSA Form 6C.

1. *Execution of the DSA Form 6-C is Mandatory.* Refusal to execute the Form 6-C, which is a Final DSA Verified Report that all Work performed complies with the DSA approved Contract Documents is a violation of Education Code section 17312 and shall be referred to the Attorney General for Prosecution.
2. *Referral to the District Attorney for Extortion.* If the Contractor's refusal to execute the DSA Form 6C is to leverage a Dispute, Claim or Litigation,



## GENERAL CONDITIONS

then the matter shall also be referred to the District Attorney for prosecution for extortion.

3. *Contractor shall be Responsible for All Costs to Certify the Project.* The District may certify the Project complies with Approved Plans and Specifications by utilizing the procedures under the Project Certification Guide (located at the DSA website). All costs for professionals, inspection, and testing required for an alternate Project Certification shall be the Contractor's responsibility and the District reserves its right to institute legal action against the Contractor and Contractor's Surety for all costs to certify the Project and all costs to correct Non-Compliant Work that is discovered during the Alternate Certification Process.
- f. ADA Work that must be corrected to receive DSA certification. See Article 12.2.
- g. Maintenance Manuals. At least thirty (30) days prior to final inspection, three (3) copies of complete operations and maintenance manuals, repair parts lists, service instructions for all electrical and mechanical equipment, and equipment warranties shall be submitted, along with indexed PDF files. All installation, operating, and maintenance information and Drawings shall be bound in 8½" x 11" binders. Provide a table of contents in front and all items shall be indexed with tabs. Each manual shall also contain a list of Subcontractors, with their addresses and the names of persons to contact in cases of emergency. Identifying labels shall provide names of manufactures, their addresses, ratings, and capacities of equipment and machinery.
  1. Maintenance manuals shall also be delivered in electronic media for the Project. Any demonstration videos shall also be provided on electronic media.
- h. Inspection Requirements. Before calling for final inspection, Contractor shall determine that the following Work has been performed:
  1. The Work has been completed;
  2. All fire/ life safety items are completed and in working order;
  3. Mechanical and electrical Work complete, fixtures in place, connected and tested;
  4. Electrical circuits scheduled in panels and disconnect switches labeled;
  5. Painting and special finishes complete;
  6. Doors complete with hardware, cleaned of protective film relieved of sticking or binding and in working order;
  7. Tops and bottoms of doors sealed;
  8. Floors waxed and polished as specified;

## **GENERAL CONDITIONS**

9. Broken glass replaced and glass cleaned;
10. Grounds cleared of Contractor's equipment, raked clean of debris, and trash removed from Site;
11. Work cleaned, free of stains, scratches, and other foreign matter, replacement of damaged and broken material;
12. Finished and decorative work shall have marks, dirt and superfluous labels removed;
13. Final cleanup, as in Article 3.12;
14. All Work pursuant to Article 9.11.2; and
15. Furnish a letter to District stating that the District's Representative or other designated person or persons have been instructed in working characteristics of mechanical and electrical equipment.

### 9.9.3 Costs of Multiple Inspections

More than two (2) requests of the District to make inspections required under Article 9.9.1 shall be considered an additional service of Architect, Inspector, Engineer or other consultants shall be the Contractor's responsibility pursuant to Article 4.5 and all subsequent costs will be prepared as a Deductive Change Order.

## 9.10 **PARTIAL OCCUPANCY OR USE**

### 9.10.1 District's Rights

The District may occupy or use any completed or partially completed portion of the Work at any stage. The District and the Contractor shall agree in writing to the responsibilities assigned to each of them for payments, security, maintenance, heat, utilities, damage to the Work, insurance, the period for correction of the Work, and the commencement of warranties required by the Contract Documents. If District and Contractor cannot agree as to responsibilities such disagreement shall be resolved pursuant to Article 4.6. When the Contractor considers a portion complete, the Contractor shall prepare and submit a Punch List to the District as provided under Article 9.9.1.

### 9.10.2 Inspection Prior to Occupancy or Use

Immediately prior to such partial occupancy or use, the District, the Contractor, and the Architect shall jointly inspect the area to be occupied or portion of the Work to be used in order to determine and record the condition of the Work.

### 9.10.3 No Waiver

Unless otherwise agreed upon, partial occupancy or use of a portion or portions of the Work shall not constitute acceptance of Work not complying with the requirements of the Contract Documents.

## **GENERAL CONDITIONS**

### **9.11 COMPLETION AND FINAL PAYMENT**

#### **9.11.1 Final Payment (90% Billing if Substantially Complex Finding and 95% Billing If No Finding Is Made)**

The following items must be completed before the Final Payment Application will be accepted for processing at Substantial Completion of the Project:

- a. Inspector sign-off of each item in the DSA 152 Project Inspection Card;
- b. The Project has reached the Punch List items under Article 9.9.1.2 and the Project has been determined to be Substantially Complete under Article 1.1.46;
- c. Removal of temporary facilities and services;
- d. Testing, adjusting and balance records are complete;
- e. Removal of surplus materials, rubbish, and similar elements;
- f. Changeover of door locks;
- g. Deductive items pursuant to Article 9.6 and Article 2.2; and
- h. Completion and submission of all final Change Orders for the Project.

#### **9.11.2 Final Inspection (Punch List Completion)**

Contractor shall comply with Punch List procedures under Article 9.9.1.1, and maintain the presence of Project Superintendent and Project Manager (not replacement project superintendent or project manager) until the Punch List is complete to ensure proper and timely completion of the Punch List. Under no circumstances shall Contractor demobilize its forces prior to completion of the Punch List.

Upon completion of the Work under Article 9.9.1, the Contractor shall notify the District and Architect, who shall again inspect such Work. If the Architect and the District find the Work contained in the Punch List acceptable under the Contract Documents, the Work shall have reached Final Completion. Architect shall notify Contractor, who shall then submit to the Architect its Application for Retention Payment. This Application for Retention Payment shall contain any deductions under Article 9.6, including but not limited to incomplete Punch List items under Article 9.9.1.

Upon receipt and approval of Application for Retention Payment, the Architect shall issue a Form 6 stating that to the best of its knowledge, information, and belief, and on the basis of its observations, inspections, and all other data accumulated or received by the Architect in connection with the Work, such Work has been completed in accordance with the Contract Documents. The District shall thereupon inspect such Work and either accept the Work as complete or notify the Architect and the Contractor in writing of reasons why the Work is not complete. Upon acceptance of the Work of the Contractor as fully complete (which, absent unusual circumstances, will occur when the Punch List items have been satisfactorily completed), the District shall record a Notice of Completion with the County Recorder, and the Contractor shall, upon receipt of payment from the District, pay the amounts due Subcontractors.

## GENERAL CONDITIONS

If the Architect and the District find that the Work contained in the Punch List is unacceptable, then Contractor shall issue a valued Punch List within 5 days after the date the Punch List time ends. If Contractor does not issue such a list, the District or Architect may issue a valued Punch List to the Contractor and withhold up to 150% of the value of the Punch List Work pursuant to Article 2.2 of this Agreement.

### 9.11.3 Retainage (100% Billing for the Entire Project)

The retainage, less any amounts disputed by the District or which the District has the right to withhold pursuant to the Contract Documents (including but not limited to incomplete Punch List items under Article 9.9.1), shall be paid after approval by the District of the Application for Retention Payment, after the satisfaction of the conditions set forth in Article 9, the Final Inspection under Article 9.11.2 is completed, and after thirty-five (35) days after the acceptance of the Work and recording of the Notice of Completion by District. No interest shall be paid on any retainage, or on any amounts withheld due to a failure of the Contractor to perform, in accordance with the terms and conditions of the Contract Documents, except as provided to the contrary in any escrow agreement between the District and the Contractor.

- a. Procedures for Application for Retention Payment. The following conditions must be fulfilled prior to release of Retention Payment:
  1. A full and final waiver or release of all stop notices in connection with the Work shall be submitted by Contractor, including a release of stop notice in recordable form, together with (to the extent permitted by law) a copy of the full and final release of all Stop Notice rights.
  2. The Contractor shall have made all corrections, including all Punch List Items, to the Work which are required to remedy any defects therein, to obtain compliance with the Contract Documents or any requirements of applicable codes and ordinances, or to fulfill any of the orders or directions of District required under the Contract Documents.
  3. Each Subcontractor shall have delivered to the Contractor all written guarantees, warranties, applications, releases from the Surety and warranty bonds (if applicable) required by the Contract Documents for its portion of the Work.
  4. Contractor must have completed all requirements set forth in Article 9.9
  5. Contractor must have issued a Form 6C for the Project.
  6. The Contractor shall have delivered to the District all manuals and materials required by the Contract Documents.
  7. The Contractor shall have completed final clean up as required by Article 3.12

## GENERAL CONDITIONS

8. Contractor shall have all deductive items under Article 9.6 and Article 2.2 submitted as part of the Retention Payment.

### 9.11.4 Recording of a Notice of Completion After Punch List Period and Final Inspection.

When the Work, or designated portion thereof, is complete or the District has completed the Article 9.6 and/or the Article 2.2 process, whichever occurs first, the District will file either a Notice of Completion or a Notice of Completion noting valued Punch List items. Valued Punch List items will be deducted from the Retention Payment.

During the time when Work is being performed on the Punch List, the Project does not meet the definition of "Complete" under Public Contract Code section 7107(c)(1) even if there is "beneficial occupancy" of the Project since that has been no "cessation of labor" on the Project. Completion of Punch List under this Article is not "testing, startup, or commissioning by the public entity or its agent." In other words, the continuing Punch List Work is Contractor labor on the Project until each and every item of Punch List Work is complete or the time periods under Article 9.9.1 have expired.

### 9.11.5 Warranties

Warranties required by the Contract Documents shall commence on the date of Completion of the entire Work. Warranty periods DO NOT commence at Substantial Completion or when a particular Subcontractor work is complete. No additional charges, extras, Change Orders, or Claims may be sought for warranties commencing from the Notice of Completion.

District shall have the right to utilize equipment, test, and operate as necessary for acclimation, or testing without voiding or starting warranties. Taking beneficial occupancy shall not start warranties except in the case where the District agrees, in writing, that warranties shall commence running or where the District is taking phased occupancy of specific buildings or areas and completes separate Punch Lists as further addressed in Article 4.2.7.

### 9.11.6 Time for Submission of Application for Final Payment and Retention Payment (Unilateral Processing of Final and Retention Payment Application).

If Contractor submits a Final Payment Application which fails to include deductive items under Article 9.6, the District or Architect shall note this defective request for Final Payment Application. The Contractor shall be notified that specific deductive items shall be included in the Final Payment Application. If Contractor either continues to submit the Final Payment Application without deductive items under Article 9.6, or a period of 14 calendar days passes after Contractor is provided written notice of deductive items for inclusion in Final Payment Application, then District may either alter the Final Payment Application and recalculate the math on the Final Payment Application to address the Article 9.6 deductive items or process a unilateral Final Payment Application.

### 9.11.7 Unilateral Release of Retention

After the recordation of the Notice of Completion, or within sixty (60) days following the completion of the Punch List or the expiration of the time for completion of Punch List under Article 9.9.1, if Contractor does not make an Application for Release of Retention, the District may unilaterally release retention less any deducts under Article 9.6 and/or Article 2.2, withholds due to stop notices, or withholdings due to other defective Work on the Project. District may also choose to unilaterally release Retention after deduction of 150% of any disputed items, which may also include items under Article 9.6

## **GENERAL CONDITIONS**

and 2.2. If a deduction pursuant to Article 9.6 is made from Retention, a letter deducting specific valued items shall be considered a notice of Default under the terms of the Escrow Agreement.

### **9.12 SUBSTITUTION OF SECURITIES**

The District will permit the substitution of securities in accordance with the provisions of Public Contract Code section 22300 as set forth in the form contained in the Bid Documents.

## **GENERAL CONDITIONS**

### **ARTICLE 10 PROTECTION OF PERSONS AND PROPERTY**

#### **10.1 SAFETY PRECAUTIONS AND PROGRAMS**

##### **10.1.1 Contractor Responsibility**

The Contractor shall be responsible for all damages to persons or property that occur as a result of its fault or negligence in connection with the prosecution of this Contract and shall take all necessary measures and be responsible for the proper care and protection of all materials delivered and Work performed until completion and final acceptance by the District. All Work shall be solely at the Contractor's risk, with the exception of damage to the Work caused by "acts of God" as defined in Public Contract Code section 7105(b)(2).

Contractor shall take, and require Subcontractor to take, all necessary precautions for safety of workers on the Work and shall comply with all applicable federal, state, local and other safety laws, standards, orders, rules, regulations, and building codes to prevent accidents or injury to persons on, about, or adjacent to premises where Work is being performed and to provide a safe and healthful place of employment. In addition to meeting all requirements of OSHA, Cal-OSHA, state, and local codes, Contractor shall furnish, erect and properly maintain at all times, as directed by District or Architect or required by conditions and progress of Work, all necessary safety devices, safeguards, construction canopies, signs, audible devices for protection of the blind, safety rails, belts and nets, barriers, lights, and watchmen for protection of workers and the public, and shall post danger signs warning against hazards created by such features in the course of construction. Contractor shall designate a responsible member of its organization on the Work, whose duty shall be to post information regarding protection and obligations of workers and other notices required under occupational safety and health laws, to comply with reporting and other occupational safety requirements, and to protect the life, safety and health of workers. The name and position of person so designated shall be reported to District by Contractor. Contractor shall correct any violations of safety laws, rules, orders, standards, or regulations. Upon the issuance of a citation or notice of violation by the Division of Occupational Safety and Health, such violation shall be corrected promptly.

##### **10.1.2 Subcontractor Responsibility**

Contractor shall require that Subcontractors participate in, and enforce, the safety and loss prevention programs established by the Contractor for the Project, which will cover all Work performed by the Contractor and its Subcontractors. Each Subcontractor shall designate a responsible member of its organization whose duties shall include loss and accident prevention, and who shall have the responsibility and full authority to enforce the program. This person shall attend meetings with the representatives of the various Subcontractors employed to ensure that all employees understand and comply with the programs.

##### **10.1.3 Cooperation**

All Subcontractors and material or equipment suppliers shall cooperate fully with Contractor, the District, and all insurance carriers and loss prevention engineers.

##### **10.1.4 Accident Reports**

## GENERAL CONDITIONS

Subcontractors shall immediately, within two (2) days, report in writing to the Contractor all accidents whatsoever arising out of, or in connection with, the performance of the Work, whether on or off the Site, which caused death, personal injury, or property damage, giving full details and statements of witnesses. In addition, if death or serious injuries or serious damages are caused, the accident shall be reported within four (4) days by telephone or messenger. Contractor shall thereafter immediately, within two (2) days, report the facts in writing to the District and the Architect giving full details of the accident.

### 10.1.5 First-Aid Supplies at Site

The Contractor will provide and maintain at the Site first-aid supplies which complies with the current Occupational Safety and Health Regulations.

### 10.1.6 Material Safety Data Sheets and Compliance with Proposition 65

Contractor is required to have material safety data sheets available in a readily accessible place at the job site for any material requiring a material safety data sheet per the Federal "hazard communication" standard, or employees' "right-to-know law." The Contractor is also required to properly label any substance brought into the job site, and require that any person working with the material, or within the general area of the material, is informed of the hazards of the substance and follows proper handling and protection procedures.

Contractor is required to comply with the provisions of California Health and Safety Code section 25249, et seq., which requires the posting and giving of notice to persons who may be exposed to any chemical known to the State of California to cause cancer. The Contractor agrees to familiarize itself with the provisions of this Section, and to comply fully with its requirements.

### 10.1.7 Non-Utilization of Asbestos Material

**NO ASBESTOS OR ASBESTOS-CONTAINING PRODUCTS SHALL BE USED IN THIS CONSTRUCTION OR IN ANY TOOLS, DEVICES, CLOTHING, OR EQUIPMENT USED TO AFFECT THIS CONSTRUCTION.**

Asbestos and/or asbestos-containing products shall be defined as all items containing, but not limited to, chrysotile, amosite, anthophyllite, tremolite, and antinolite.

Any or all material containing greater than one-tenth of one percent (>.1%) asbestos shall be defined as asbestos-containing material.

All Work or materials found to contain asbestos or Work or material installed with asbestos-containing equipment will be immediately rejected and this Work will be removed at no additional cost to the District.

Decontamination and removal of Work found to contain asbestos or Work installed with asbestos-containing equipment shall be done only under supervision of a qualified consultant, knowledgeable in the field of asbestos abatement and accredited by the Environmental Protection Agency.

The asbestos removal contractor shall be an EPA accredited contractor qualified in the removal of asbestos and shall be chosen and approved by the asbestos consultant, who shall have sole discretion and final determination in this matter.



## **GENERAL CONDITIONS**

The asbestos consultant shall be chosen and approved by the District, who shall have sole discretion and final determination in this matter.

The Work will not be accepted until asbestos contamination is reduced to levels deemed acceptable by the asbestos consultant.

Interface of Work under this Contract with Work containing asbestos shall be executed by the Contractor at his risk and at his discretion, with full knowledge of the currently accepted standards, hazards, risks, and liabilities associated with asbestos work and asbestos-containing products. By execution of this Contract, the Contractor acknowledges the above and agrees to hold harmless District and its assigns for all asbestos liability which may be associated with this work and agrees to instruct his employees with respect to the above-mentioned standards, hazards, risks, and liabilities.

### **10.2 SAFETY OF PERSONS AND PROPERTY**

#### **10.2.1 The Contractor**

The Contractor shall take reasonable precautions for the safety of, and shall provide reasonable protection to prevent damage, injury, or loss to:

- a. Employees on the Work and other persons who may be affected thereby;
- b. The Work, material, and equipment to be incorporated therein, whether in storage on or off the Site, under the care, custody, or control of the Contractor or the Contractor's Subcontractors or Sub-subcontractors; and
- c. Other property at the Site or adjacent thereto such as trees, shrubs, lawns, walks, pavement, roadways, structures, and utilities not designated for removal, relocation, or replacement in the course of construction.

Contractor is constructive owner of Project site as more fully discussed in Article 6.2.

#### **10.2.2 Contractor Notices**

The Contractor shall give notices and comply with applicable laws, ordinances, rules, regulations, and lawful orders of public authorities bearing on the safety of persons or property or their protection from damage, injury, or loss.

#### **10.2.3 Safety Barriers and Safeguards**

The Contractor shall erect and maintain, as required by existing conditions and performance of the Contract, reasonable safeguards for safety and protection, including posting danger signs and other warnings against hazards, promulgating safety regulations, and notifying owners and users of adjacent sites and utilities.

#### **10.2.4 Use or Storage of Hazardous Material**

When use or storage of explosives, other hazardous materials or equipment, or unusual methods are necessary for execution of the Work, the Contractor shall exercise utmost care and carry on such activities under supervision of properly qualified personnel. The Contractor shall notify the District

## GENERAL CONDITIONS

any time that explosives or hazardous materials are expected to be stored on Site. Location of storage shall be coordinated with the District and local fire authorities.

### 10.2.5 Protection of Work

The Contractor and Subcontractors shall continuously protect the Work, the District's property, and the property of others, from damage, injury, or loss arising in connection with operations under the Contract Documents. The Contractor and Subcontractors, at their own expense, shall make good any such damage, injury, or loss, except such as may be solely due to, or caused by, agents or employees of the District.

The Contractor, at Contractor's expense, will remove all mud, water, or other elements as may be required for the proper protection and prosecution of its Work.

Contractor shall take adequate precautions to protect existing roads, sidewalks, curbs, pavements, utilities, adjoining property and structures (including, without limitation, protection from settlement or loss of lateral support), and to avoid damage thereto, and repair any damage thereto caused by construction operations. All permits, licenses, or inspection fees required for such repair Work shall be obtained and paid for by Contractor.

### 10.2.6 Requirements for Existing Sites

Contractor shall (unless waived by the District in writing):

- a. When performing construction on existing sites, become informed and take into specific account the maturity of the students on the Site; and perform Work which may interfere with school routine before or after school hours, enclose working area with a substantial barricade, and arrange Work to cause a minimum amount of inconvenience and danger to students and faculty in their regular school activities. The Contractor shall comply with Specifications and directives of the District regarding the timing of certain construction activities in order to avoid unnecessary interference with school functioning.
- b. Avoid performing any Work that will disturb students during testing.
- c. Provide substantial barricades around any shrubs or trees indicated to be preserved.
- d. Deliver materials to building area over route designated by Architect.
- e. Take preventive measures to eliminate objectionable dust, noise, or other disturbances.
- f. Confine apparatus, the storage of materials, and the operations of workers to limits indicated by law, ordinances, permits or directions of Architect; and not interfere with the Work or unreasonably encumber premises or overload any structure with materials; and enforce all instructions of District and Architect regarding signs, advertising, fires, and smoking and require that all workers comply with all regulations while on the Project site.

## GENERAL CONDITIONS

- g. Take care to prevent disturbing or covering any survey markers, monuments, or other devices marking property boundaries or corners. If such markers are disturbed by accident, they shall be replaced by an approved land surveyor or civil engineer and all maps and records required therefrom shall be filed with county and local authorities, at no cost to the District. All filing and plan check fees shall be paid by Contractor.
- h. Provide District on request with Contractor's written safety program and safety plan for each site.

### 10.2.7 Shoring and Structural Loading

The Contractor shall not impose structural loading upon any part of the Work under construction or upon existing construction on or adjacent to the Site in excess of safe limits, or loading such as to result in damage to the structural, architectural, mechanical, electrical, or other components of the Work. The design of all temporary construction equipment and appliances used in construction of the Work and not a permanent part thereof, including, without limitation, hoisting equipment, cribbing, shoring, and temporary bracing of structural steel, is the sole responsibility of the Contractor. All such items shall conform with the requirements of governing codes and all laws, ordinances, rules, regulations, and orders of all authorities having jurisdiction. The Contractor shall take special precautions, such as shoring of masonry walls and temporary tie bracing of structural steel Work, to prevent possible wind damage during construction of the Work. The installation of such bracing or shoring shall not damage the Work in place or the Work installed by others. Any damage which does occur shall be promptly repaired by the Contractor at no cost to the District.

### 10.2.8 Conformance within Established Limits

The Contractor and Subcontractors shall confine their construction equipment, the storage of materials, and the operations of workers to the limits indicated by laws, ordinances, permits, and the limits established by the District or the Contractor, and shall not unreasonably encumber the premises with construction equipment or materials.

### 10.2.9 Subcontractor Enforcement of Rules

Subcontractors shall enforce the District's and the Contractor's instructions, laws, and regulations regarding signs, advertisements, fires, smoking, the presence of liquor, and the presence of firearms by any person at the Site.

### 10.2.10 Site Access

The Contractor and the Subcontractors shall use only those ingress and egress routes designated by the District, observe the boundaries of the Site designated by the District, park only in those areas designated by the District, which areas may be on or off the Site, and comply with any parking control program established by the District, such as furnishing license plate information and placing identifying stickers on vehicles.

### 10.2.11 Security Services.

The Contractor shall be responsible for providing security services for the Site as needed for the protection of the Site and as determined in the District's sole discretion.

## **GENERAL CONDITIONS**

### **10.3 EMERGENCIES**

#### **10.3.1 Emergency Action**

In an emergency affecting the safety of persons or property, the Contractor shall take any action necessary, at the Contractor's discretion, to prevent threatened damage, injury, or loss. Additional compensation or extension of time claimed by the Contractor on account of an emergency shall be determined as provided in Article 7.

#### **10.3.2 Accident Reports**

The Contractor shall promptly report in writing to the District all accidents arising out of or in connection with the Work, which caused death, personal injury, or property damage, giving full details and statements of any witnesses in conformance with Article 10.1.4. In addition, if death, serious personal injuries, or serious property damages are caused, the accident shall be reported in accordance with Article 10.1.4, immediately by telephone or messenger to the District.

### **10.4 HAZARDOUS MATERIALS**

#### **10.4.1 Discovery of Hazardous Materials**

In the event the Contractor encounters or suspects the presence on the job site of material reasonably believed to be asbestos, polychlorinated biphenyl (PCB), or any other material defined as being hazardous by § 25249.5 of the California Health and Safety Code, which has not been rendered harmless, the Contractor shall immediately stop Work in the area affected and report the condition to the District and the Architect in writing, whether or not such material was generated by the Contractor or the District. The Work in the affected area shall not thereafter be resumed, except by written agreement of the District and the Contractor, if in fact the material is asbestos, polychlorinated biphenyl (PCB), or other hazardous material, and has not been rendered harmless. The Work in the affected area shall be resumed only in the absence of asbestos, polychlorinated biphenyl (PCB), or other hazardous material, or when it has been rendered harmless by written agreement of the District and the Contractor.

#### **10.4.2 Hazardous Material Work Limitations**

In the event that the presence of hazardous materials is suspected or discovered on the Site (except in cases where asbestos and other hazardous material Work in the Contractor's responsibility), the District shall retain an independent testing laboratory to determine the nature of the material encountered and whether corrective measures or remedial action is required. The Contractor shall not be required pursuant to Article 7 to perform without consent any Work in the affected area of the Site relating to asbestos, polychlorinated biphenyl (PCB), or other hazardous material, until any known or suspected hazardous material has been removed, or rendered harmless, or determined to be harmless by District, as certified by an independent testing laboratory and approved by the appropriate government agency.

#### **10.4.3 Indemnification by Contractor for Hazardous Material Caused by Contractor**

In the event the hazardous materials on the Project Site is caused by the Contractor, the Contractor shall pay for all costs of testing and remediation, if any, and shall compensate the District for any additional costs incurred as a result of Contractor's generation of hazardous material on the Project Site. In addition, the Contractor shall defend, indemnify and hold harmless District and its agents, officers,

## **GENERAL CONDITIONS**

and employees from and against any and all claims, damages, losses, costs and expenses incurred in connection with, arising out of, or relating to, the presence of hazardous material on the Project Site.

### 10.4.4 Terms of Hazardous Material Provision

The terms of this Hazardous Material provision shall survive the completion of the Work and/or any termination of this Contract.

# **GENERAL CONDITIONS**

## **ARTICLE 11 INSURANCE AND BONDS**

### **EXHIBIT A OWNER CONTROLLED INSURANCE PROGRAM (OCIP)**

#### **11.1 Introduction**

The **District**, hereinafter called the “Owner” has elected, at its sole discretion, to implement an Owner Controlled Insurance Program (“OCIP”) under the Statewide Educational Wrap Up Program (“SEWUP”). The SEWUP Joint Powers Authority (“JPA”) will be providing the OCIP on behalf of the Owner. All terms and conditions of the SEWUP Contractual Provisions will apply during the term of the contract.

The SEWUP JPA will provide Workers’ Compensation, Employer’s Liability, General & Excess Liability, Contractor’s Pollution Liability, and Builder’s Risk insurance for all Enrolled Contractors (and their Enrolled Subcontractors of every tier) and other designated parties for work performed at the Project Site (hereinafter called “Project”). The Owner agrees to pay all premiums associated with the OCIP, unless otherwise stated in this section and in other contract documents.

Insurance coverage provided under the OCIP is limited in scope and specific to Work performed after the inception date of enrollment into the OCIP. Labor and ongoing operations related to offsite locations are not covered by the OCIP. In addition to any insurance provided by the Owner, all Contractors/Subcontractors will be responsible for providing certain insurance as specified in section 11.7. The Owner recommends that Contractors discuss the OCIP with their insurance agents, brokers or consultants to assure that other proper coverages are maintained, prior to contract acceptance.

Keenan & Associates, hereinafter called “Program Administrator”, shall administer the OCIP on behalf of the SEWUP JPA. At all times, all Contractors/Subcontractors, shall (a) cooperate with Owner, Program Administrator, and all OCIP insurers, as applicable, and their respective consultants, agents and representatives, in its or their administration of the OCIP and all other terms and conditions described herein and (b) comply with the terms, conditions, warranties, and subjectivities of the insurance policies provided pursuant to the OCIP, including, without limitation, any and all directives and requirements of Owner’s and the OCIP insurers’ respective consultants, agents and representatives, including, without limitation, any directive or requirement relating to loss control, and quality control, and the closure to Owner’s satisfaction of open items on any and all quality control checklists and inventories.

#### **a. Participation in the OCIP**

Participation in the OCIP is mandatory but not automatic. Each Eligible Contractor/Subcontractor must follow the guidelines, as specified in section 11.5.

**Enrollment (Definition):** An Eligible Contractor/Subcontractor is considered Enrolled once required documents are received, reviewed and processed by the OCIP Program Administrator to the insurer. (See Sections 11.7 and 11.8)

**Contractor (Definition):** Includes all vendors, suppliers, businesses, persons, or entities and entities which the Owner has engaged directly by contract to perform services relating to the Project.

**Subcontractor (Definition):** Includes all vendors’ suppliers, businesses, and other persons or entities that have been engaged by a Contractor to perform, or assist with the performance of, services relating to the Project.

## GENERAL CONDITIONS

Eligible (Definition): Includes all Contractors/Subcontractors providing direct labor on the Project, and excludes Ineligible Contractors, as defined below. Temporary labor services and leasing companies are to be treated as Eligible Contractors.

Ineligible (Definition): Ineligible (Definition): It is not the intent to insure (but is not limited to): consultants; suppliers; abatement and/or removal of hazardous materials; vendors; materials dealers; surveyors; consultants; guard services; non-construction janitorial services; and truckers, including trucking to the Project where delivery is the only scope of work performed; contractors subbing out installation who are not performing labor on the project site; and contractors performing landscape maintenance (though landscape work itself is covered). Ineligible parties are required to ensure that any eligible subcontractors who provide on-site labor comply with the OCIP Enrollment. Any questions regarding a Contractor's status as "Eligible" or "Ineligible" should be referred by written request to Owner and approved by the Program Administrator.

**EACH CONTRACTOR/SUBCONTRACTOR MUST INCLUDE THIS DOCUMENT WITH THEIR BID SPECIFICATIONS TO ANY AND ALL SUBCONTRACTORS.** Any contractor/subcontractor's failure to comply with the OCIP Administrator and all OCIP requirements shall be considered non-compliant under the contract.

Enrollment of each Contractor's eligible Subcontractors is mandatory. Contractor shall notify Owner and the Program Administrator in writing of the identity of each Subcontractor, and shall cause each Subcontractor to notify the Program Administrator in writing of the identity of each of its Sub-subcontractors, prior to such parties' commencement of their portion of the Work and prior to their entry onto the Project. Subcontractors shall not be deemed enrolled until the Program Administrator and OCIP insurers receive and approve a completed Contract Enrollment Form, for each awarded contract. Enrollment is required prior to commencement of on-site activities but no contractor shall be enrolled sooner than 30 days prior to their start date. Each Subcontractor shall be solely responsible for any and all losses, damages, claims, liabilities, and suits arising out of such Subcontractor's failure to enroll, or delay in enrolling, any of its Subcontractors.

Unless otherwise directed by the Owner, Ineligible Contractors and Subcontractors will be required to maintain their own insurance for both on-site and off-site activities and will be required to participate in the Project Safety Program (**See Section 1.16**). Minimum Insurance and endorsement requirements are located in Section **11.7 & 11.8**.

b. Project Site and Offsite Premises

Coverages provided by the OCIP are Project Site specific. The Project Site shall be designated by the Owner. The Project Site consists of any and all projects that are endorsed to this policy, which includes the:

1. Ways and means adjoining the endorsed project site.
2. Adjacent locations to the endorsed projects sites where incidental operations are being performed, excluding permanent locations.

With the exception of 1 and 2 mentioned above, off-site locations, labor and ongoing operations are not covered by the OCIP. It will be the responsibility of each Contractor/Subcontractor to maintain off-site insurance, as identified in Section 11.7, which specifies coverage types and minimum limits. Contractor/Subcontractor will promptly furnish to the Owner, or its designated representative, Certificates of Insurance evidencing that all required insurance is in force.

## **GENERAL CONDITIONS**

### **11.2 Prequalification & Cost Identification**

#### **a. Contractor Pre-Qualification**

Pursuant to Government Code Section 4420.5, Bidders must meet certain minimum standards in order to bid on the Owners' Project. The following qualification standards apply to ALL Bidding Contractors at time of bid opening:

- 1. Have an average Workers' Compensation Experience Modification Rate (EMR) of 1.25 or less over the last five (5) years.**
- 2. Have Zero (0) Serious and Willful violations (Labor Code Section 6300) against them in the past five (5) years**
- 3. Provide evidence of an Injury and Illness Prevention Program (IIPP). Evidence is required to be submitted after bid opening and prior to bid award.**

**FAILURE TO MEET THESE MINIMUM STANDARDS SHALL DISQUALIFY THE BIDDER.**

#### **b. Contractor Insurance Cost Identification**

Contractor's base bid shall exclude all costs for insurance coverages provided under the OCIP. If insurance cost is not removed, the bidder may not qualify as the lowest responsive bidder. The Bidder declares under penalty of perjury under California law, that the base bid excludes any costs relating to any insurance coverages afforded under the OCIP and that each subcontractor to the Bidder has similarly excluded costs for any insurance coverage afforded under the OCIP.

#### **c. Change Order Pricing**

All Contractors/Subcontractors declare, under penalty of perjury under California law, that the change order is priced to exclude any costs relating to any insurance coverage afforded under the OCIP.

### **11.3 Owner-Provided Insurance Coverages**

**CONTRACTOR/SUBCONTRACTOR SHOULD REFER TO THE ACTUAL POLICIES FOR DETAILS CONCERNING COVERAGE, EXCLUSIONS, AND LIMITATIONS. IN THE EVENT OF ANY CLAIM OR QUESTION REGARDING COVERAGE PROVIDED BY THE OCIP, THE ORIGINAL POLICIES WILL PREVAIL AS THE SOLE BINDING AGREEMENT. OCIP POLICIES AND PROJECT INSURANCE MANUAL ARE AVAILABLE UPON WRITTEN REQUEST TO THE PROGRAM ADMINISTRATOR.**

OCIP coverage applies only to Work performed under the contract at the Project (see Section 11.1, 11.1b for definition). All Contractors must provide their own insurance for Automobile Liability and off-site locations, labor, and operations.

Such policies or programs may be amended from time to time, and the terms of such policies or programs, as amended, are incorporated herein by reference.

The Contractors/Subcontractors enrolled in the OCIP agree that the OCIP policies' limits of liability, coverage terms and conditions shall determine the scope of coverage provided by the OCIP.

- a. Workers' Compensation and Employer's Liability Insurance, will be provided in accordance with applicable state laws, to all Enrolled Contractors/Subcontractors, each as named insured, and issued an individual policy) reflecting the following Limits of Liability:**



## GENERAL CONDITIONS

### **Workers' Compensation:**

- California Statutory Benefits

### **Employer's Liability:**

- \$1,000,000 Bodily Injury each Accident
- \$1,000,000 Bodily Injury by Disease – Policy Limit
- \$1,000,000 Bodily Injury by Disease – Each Employee

1. Deductible: None
2. Exclusions: The known exclusions for this coverage are set forth on the table attached as

<b>KNOWN OCIP POLICY EXCLUSIONS</b>	
<b><u>Workers Compensation</u></b>	<b><u>General Liability</u></b>
Bodily Injury Outside US or Canada	Aircraft, Auto or Watercraft
Bodily Injury To Any Member of Flying Crew	Asbestos
Bodily Injury To Person Subject To Federal Workers' Compensation	Certain Exclusions To Medical Payments Coverage
Bodily Injury To Person Subject To Occupational Disease Laws	Certain Exclusions To Personal and Advertising Injury Liability
Contractual Liability	Certified Acts of Terrorism
Employees Knowingly Employed Illegally	Contractual Liability (Limited Coverage Provided)
Employment Related Practices	Employers Liability
Intentional or Aggravated Bodily Injury	Employment Related Practices
Obligations Imposed By Disability Benefits or Any Similar Law	Expected or Intended Injury
Obligations Imposed By Occupational Disease Laws	Exterior Insulation and Finish Systems (EIFS) "Subject to Installation Requirements"
Obligations Imposed By Unemployment Compensation Laws	Fungi Or Bacteria
Obligations Imposed By Workers' Compensation Laws	Lead
State or Federal Law Violation Fines, Penalties	Mobile Equipment
<b><u>Builders Risk</u></b>	Nuclear
Asbestos	Personal and Advertising Bodily Injury
Certain Offsite Property	Pollution
Certain Release, Discharge, Escape, or Dispersal Of Contaminants	Prior Continuous, or Progressively Deteriorating Injury or Damage
Certified Acts of Terrorism (Can be added)	Professional Liability
Cessation of Work	Recall of Products, Work Or Impaired Property
Contractor's Tools, Machinery, Plans, Equipment	Silica or Silica Mixed Dust
Cost of Making Good	Violation of Statutes Governing Collecting, Transmitting Information
Damage To Existing Property (Can be added)	Violation of Statutes Governing Email, Fax, Phone Calls
Damage While Testing Prototype or Used Machinery/Equipment	War
Damages, Fines, Penalties At Government Agency or Court Order	Workers Compensation and Similar Laws
Disappearance or When Revealed By Inventory Shortage Alone	<b><u>Contractors Pollution Liability</u></b>
Earth Movement (Optional sublimits can be added)	Auto, Aircraft, Vessel Or Rolling Stock
Electrical, Magnetic, or Errors Related To Electronic Records	Claims Between Certain Insured's
Financial Accounts, Instruments, Stamps, Deeds, Precious Material	Contractual Liability
Flood (Optional sublimits can be added)	Damage To Property
Foreign Terrorism	Disposal Sites
Infidelity, Dishonesty, Fraudulent Activity Of Insured	Employment Related Practices
Land, Values of Land, Cut, & Fill etc. Prior to Project Commencement	Fines, Penalties, and Treble Damages
Loss Under Any Manufacturer or Supplier Guarantee/Warranty	Hazardous Materials Facility
Normal Subsidence	Intentional Acts
Nuclear	Nuclear
Offshore Or Barrier Island Property	Other Entities
Property That Stores, Processes, or Handles Radioactive Materials	Pre-Existing Conditions
Rolling Stock, Aircraft, Watercraft	Products
Software Loss, unless results from an Open Peril	Related Entities and Individuals
Standing Timber, Growing Crops, Animals	Transportation Of Pollutants
Vehicles or Equipment Licensed For Highway Use	War
War and Military Action	Workers Compensation and Similar Laws

## GENERAL CONDITIONS

- . This is a summary and may not be exhaustive. The policy language may contain additional exclusionary language, limitations or carve-backs that are not identified on the table. It is the responsibility of the Contractor/Subcontractor to review the policy for the complete details of all exclusions.
3. Policy Term: The master policy effective date is October 1, 2017. The policy term is one year, with automatic one-year renewals until the Project is completed. The policy is intended to remain in effect for duration of the contractor's contractual work. Warranty work and post contract repair work is excluded. Each Contractor/Subcontractor is insured under the policy for the length of its work at the Project.
    - b. General and Excess Liability Insurance is written on an "Occurrence" form under master liability policies. Certificates of Insurance will be provided to all enrolled Contractors/Subcontractors as named insured, with the total limits of liability reflecting the following:
      - \$ 75,000,000 Bodily Injury and Property Damage Liability
      - \$145,000,000 General Aggregate
      - \$ 75,000,000 Products and Completed Operations
      - 10 Years Completed Operations
  1. Deductible: None

## GENERAL CONDITIONS

2. Exclusions: The known exclusions for this coverage are set forth on the table attached as

KNOWN OCIP POLICY EXCLUSIONS	
<b>Workers Compensation</b>	<b>General Liability</b>
Bodily Injury Outside US or Canada	Aircraft, Auto or Watercraft
Bodily Injury To Any Member of Flying Crew	Asbestos
Bodily Injury To Person Subject To Federal Workers' Compensation	Certain Exclusions To Medical Payments Coverage
Bodily Injury To Person Subject To Occupational Disease Laws	Certain Exclusions To Personal and Advertising Injury Liability
Contractual Liability	Certified Acts of Terrorism
Employees Knowingly Employed Illegally	Contractual Liability (Limited Coverage Provided)
Employment Related Practices	Employers Liability
Intentional or Aggravated Bodily Injury	Employment Related Practices
Obligations Imposed By Disability Benefits or Any Similar Law	Expected or Intended Injury
Obligations Imposed By Occupational Disease Laws	Exterior Insulation and Finish Systems (EIFS) "Subject to Installation Requirements"
Obligations Imposed By Unemployment Compensation Laws	Fungi Or Bacteria
Obligations Imposed By Workers' Compensation Laws	Lead
State or Federal Law Violation Fines, Penalties	Mobile Equipment
<b>Builders Risk</b>	Nuclear
Asbestos	Personal and Advertising Bodily Injury
Certain Offsite Property	Pollution
Certain Release, Discharge, Escape, or Dispersal Of Contaminants	Prior Continuous, or Progressively Deteriorating Injury or Damage
Certified Acts of Terrorism (Can be added)	Professional Liability
Cessation of Work	Recall of Products, Work Or Impaired Property
Contractor's Tools, Machinery, Plans, Equipment	Silica or Silica Mixed Dust
Cost of Making Good	Violation of Statutes Governing Collecting, Transmitting Information
Damage To Existing Property (Can be added)	Violation of Statutes Governing Email, Fax, Phone Calls
Damage While Testing Prototype or Used Machinery/Equipment	War
Damages, Fines, Penalties At Government Agency or Court Order	Workers Compensation and Similar Laws
Disappearance or When Revealed By Inventory Shortage Alone	<b>Contractors Pollution Liability</b>
Earth Movement (Optional sublimits can be added)	Auto, Aircraft, Vessel Or Rolling Stock
Electrical, Magnetic, or Errors Related To Electronic Records	Claims Between Certain Insured's
Financial Accounts, Instruments, Stamps, Deeds, Precious Material	Contractual Liability
Flood (Optional sublimits can be added)	Damage To Property
Foreign Terrorism	Disposal Sites
Infidelity, Dishonesty, Fraudulent Activity Of Insured	Employment Related Practices
Land, Values of Land, Cut, & Fill etc. Prior to Project Commencement	Fines, Penalties, and Treble Damages
Loss Under Any Manufacturer or Supplier Guarantee/Warranty	Hazardous Materials Facility
Normal Subsidence	Intentional Acts
Nuclear	Nuclear
Offshore Or Barrier Island Property	Other Entities
Property That Stores, Processes, or Handles Radioactive Materials	Pre-Existing Conditions
Rolling Stock, Aircraft, Watercraft	Products
Software Loss, unless results from an Open Peril	Related Entities and Individuals
Standing Timber, Growing Crops, Animals	Transportation Of Pollutants
Vehicles or Equipment Licensed For Highway Use	War
War and Military Action	Workers Compensation and Similar Laws

. This is a summary and may not be exhaustive. The policy language may contain additional exclusionary language, limitations or carve-backs that are not identified on the table. It is the responsibility of the Contractor/Subcontractor to review the policy for the complete details of all exclusions.

3. Policy Term:
- The master policy effective date is October 1, 2017. The policy is intended to remain in effect for the length of the Project or the policy end date, whichever comes first.
  - Ten years Products and Completed Operations coverage.

## **GENERAL CONDITIONS**

c. Contractor's Pollution Liability, is written on an "Occurrence" form under a master liability policy. Certificates of Insurance will be provided to all enrolled Contractors/Subcontractors, as named insured, reflecting the following Limits of Liability:

- \$5,000,000 Per Occurrence / \$5,000,000 Policy Aggregate
  - Defense costs included within limits
1. \$10,000 Deductible per Occurrence
  2. Contractor/Subcontractor shall be liable, at its expense; to the extent claims payable are attributable to their acts or omissions and/or the acts or omissions of its Subcontractors of any tier or any other entity or person for whom it may be responsible. The deductible amount shall not be reimbursed by the OCIP Insurance Program or the District.

## GENERAL CONDITIONS

3. Exclusions: The known exclusions for this coverage are set forth on the table attached as

KNOWN OCIP POLICY EXCLUSIONS	
<b>Workers Compensation</b>	<b>General Liability</b>
Bodily Injury Outside US or Canada	Aircraft, Auto or Watercraft
Bodily Injury To Any Member of Flying Crew	Asbestos
Bodily Injury To Person Subject To Federal Workers' Compensation	Certain Exclusions To Medical Payments Coverage
Bodily Injury To Person Subject To Occupational Disease Laws	Certain Exclusions To Personal and Advertising Injury Liability
Contractual Liability	Certified Acts of Terrorism
Employees Knowingly Employed Illegally	Contractual Liability (Limited Coverage Provided)
Employment Related Practices	Employers Liability
Intentional or Aggravated Bodily Injury	Employment Related Practices
Obligations Imposed By Disability Benefits or Any Similar Law	Expected or Intended Injury
Obligations Imposed By Occupational Disease Laws	Exterior Insulation and Finish Systems (EIFS) "Subject to Installation Requirements"
Obligations Imposed By Unemployment Compensation Laws	Fungi Or Bacteria
Obligations Imposed By Workers' Compensation Laws	Lead
State or Federal Law Violation Fines, Penalties	Mobile Equipment
<b>Builders Risk</b>	Nuclear
Asbestos	Personal and Advertising Bodily Injury
Certain Offsite Property	Pollution
Certain Release, Discharge, Escape, or Dispersal Of Contaminants	Prior Continuous, or Progressively Deteriorating Injury or Damage
Certified Acts of Terrorism (Can be added)	Professional Liability
Cessation of Work	Recall of Products, Work Or Impaired Property
Contractor's Tools, Machinery, Plans, Equipment	Silica or Silica Mixed Dust
Cost of Making Good	Violation of Statutes Governing Collecting, Transmitting Information
Damage To Existing Property (Can be added)	Violation of Statutes Governing Email, Fax, Phone Calls
Damage While Testing Prototype or Used Machinery/Equipment	War
Damages, Fines, Penalties At Government Agency or Court Order	Workers Compensation and Similar Laws
Disappearance or When Revealed By Inventory Shortage Alone	<b>Contractors Pollution Liability</b>
Earth Movement (Optional sublimits can be added)	Auto, Aircraft, Vessel Or Rolling Stock
Electrical, Magnetic, or Errors Related To Electronic Records	Claims Between Certain Insured's
Financial Accounts, Instruments, Stamps, Deeds, Precious Material	Contractual Liability
Flood (Optional sublimits can be added)	Damage To Property
Foreign Terrorism	Disposal Sites
Infidelity, Dishonesty, Fraudulent Activity Of Insured	Employment Related Practices
Land, Values of Land, Cut, & Fill etc. Prior to Project Commencement	Fines, Penalties, and Treble Damages
Loss Under Any Manufacturer or Supplier Guarantee/Warranty	Hazardous Materials Facility
Normal Subsidence	Intentional Acts
Nuclear	Nuclear
Offshore Or Barrier Island Property	Other Entities
Property That Stores, Processes, or Handles Radioactive Materials	Pre-Existing Conditions
Rolling Stock, Aircraft, Watercraft	Products
Software Loss, unless results from an Open Peril	Related Entities and Individuals
Standing Timber, Growing Crops, Animals	Transportation Of Pollutants
Vehicles or Equipment Licensed For Highway Use	War
War and Military Action	Workers Compensation and Similar Laws

. This is a summary and may not be exhaustive. The policy language may contain additional exclusionary language, limitations or carve-backs that are not identified on the table. It is the responsibility of the Contractor/Subcontractor to review the policy for the complete details of all exclusions.

4. Policy Term: The master policy effective date is October 1, 2017. The policy is intended to remain in effect for the length of the Project or the policy end date, whichever comes first.

- d. Builder's Risk coverage will be in place during the Course of Construction at the Project. Such insurance shall be written on a repair or replacement cost basis,

**GENERAL CONDITIONS**

subject to exclusions, sub limits, property limitations and conditions. Such insurance shall include the interests of the Owner as named insured and enrolled Contractors/Subcontractors as additional insured's. The deductible schedule is as follows:

**New Construction & Renovation**

<b>Deductible</b>	<b>Number of Buildings or Structures per Project</b>	<b>Total Insured Value (TIV)</b>	<b>Construction Class</b>
<b>\$5,000 Deductible:</b>	Projects with Single and Multiple Building(s) or Structure(s)	Up to \$15M	<ul style="list-style-type: none"> <li>• Fire Resistive</li> <li>• Non Combustible</li> <li>• Masonry Concrete</li> </ul>
	Projects with Multiple Building(s) or Structure(s)	Up to \$10M (No single building or structure greater than \$10mm in value)	<ul style="list-style-type: none"> <li>• Joisted Masonry</li> <li>• Hybrid Construction</li> </ul>
	Projects with No Vertical Construction (No Buildings or Structures)		<ul style="list-style-type: none"> <li>• Grading - Site Prep Only No Vertical Construction</li> </ul>
<b>\$10,000 Deductible:</b>	Projects with Single and Multiple Building(s) or Structure(s)	\$15M to \$50M	<ul style="list-style-type: none"> <li>• Fire Resistive</li> <li>• Non Combustible</li> <li>• Masonry Concrete</li> </ul>
	Projects with Single Building or Structure	Up to \$25M	<ul style="list-style-type: none"> <li>• Joisted Masonry</li> <li>• Hybrid Construction</li> <li>• Wood Frame</li> </ul>
	Projects with Multiple Building(s) or Structure(s)	Up to \$10M (No single building or structure greater than \$10mm in value)	<ul style="list-style-type: none"> <li>• Wood Frame</li> </ul>
<b>\$25,000*** Deductible:</b>	Projects with Single and Multiple Building(s) or Structure(s)	\$50M & above	<ul style="list-style-type: none"> <li>• Fire Resistive</li> <li>• Non Combustible</li> <li>• Masonry Concrete</li> </ul>
	Single Building or Structure Projects	\$25M & above	<ul style="list-style-type: none"> <li>• Joisted Masonry</li> <li>• Hybrid Construction</li> <li>• Wood Frame</li> </ul>

\*\*\* Structural and Non-Structural Renovation Projects with Single and Multiple Building(s) or Structure(s) – Deductibles are as per above categories, except in the event of Water Damage, where the deductible is \$25,000.

1. Contractor/Subcontractors shall be responsible for the applicable deductible. The deductible shall not be reimbursed by the OCIP Insurance Program or the District.

## GENERAL CONDITIONS

2. Exclusions: The known exclusions for this coverage are set forth on the table attached as

KNOWN OCIP POLICY EXCLUSIONS	
<b>Workers Compensation</b>	<b>General Liability</b>
Bodily Injury Outside US or Canada	Aircraft, Auto or Watercraft
Bodily Injury To Any Member of Flying Crew	Asbestos
Bodily Injury To Person Subject To Federal Workers' Compensation	Certain Exclusions To Medical Payments Coverage
Bodily Injury To Person Subject To Occupational Disease Laws	Certain Exclusions To Personal and Advertising Injury Liability
Contractual Liability	Certified Acts of Terrorism
Employees Knowingly Employed Illegally	Contractual Liability (Limited Coverage Provided)
Employment Related Practices	Employers Liability
Intentional or Aggravated Bodily Injury	Employment Related Practices
Obligations Imposed By Disability Benefits or Any Similar Law	Expected or Intended Injury
Obligations Imposed By Occupational Disease Laws	Exterior Insulation and Finish Systems (EIFS) "Subject to Installation Requirements"
Obligations Imposed By Unemployment Compensation Laws	Fungi Or Bacteria
Obligations Imposed By Workers' Compensation Laws	Lead
State or Federal Law Violation Fines, Penalties	Mobile Equipment
<b>Builders Risk</b>	Nuclear
Asbestos	Personal and Advertising Bodily Injury
Certain Offsite Property	Pollution
Certain Release, Discharge, Escape, or Dispersal Of Contaminants	Prior Continuous, or Progressively Deteriorating Injury or Damage
Certified Acts of Terrorism (Can be added)	Professional Liability
Cessation of Work	Recall of Products, Work Or Impaired Property
Contractor's Tools, Machinery, Plans, Equipment	Silica or Silica Mixed Dust
Cost of Making Good	Violation of Statutes Governing Collecting, Transmitting Information
Damage To Existing Property (Can be added)	Violation of Statutes Governing Email, Fax, Phone Calls
Damage While Testing Prototype or Used Machinery/Equipment	War
Damages, Fines, Penalties At Government Agency or Court Order	Workers Compensation and Similar Laws
Disappearance or When Revealed By Inventory Shortage Alone	<b>Contractors Pollution Liability</b>
Earth Movement (Optional sublimits can be added)	Auto, Aircraft, Vessel Or Rolling Stock
Electrical, Magnetic, or Errors Related To Electronic Records	Claims Between Certain Insured's
Financial Accounts, Instruments, Stamps, Deeds, Precious Material	Contractual Liability
Flood (Optional sublimits can be added)	Damage To Property
Foreign Terrorism	Disposal Sites
Infidelity, Dishonesty, Fraudulent Activity Of Insured	Employment Related Practices
Land, Values of Land, Cut, & Fill etc. Prior to Project Commencement	Fines, Penalties, and Treble Damages
Loss Under Any Manufacturer or Supplier Guarantee/Warranty	Hazardous Materials Facility
Normal Subsidence	Intentional Acts
Nuclear	Nuclear
Offshore Or Barrier Island Property	Other Entities
Property That Stores, Processes, or Handles Radioactive Materials	Pre-Existing Conditions
Rolling Stock, Aircraft, Watercraft	Products
Software Loss, unless results from an Open Peril	Related Entities and Individuals
Standing Timber, Growing Crops, Animals	Transportation Of Pollutants
Vehicles or Equipment Licensed For Highway Use	War
War and Military Action	Workers Compensation and Similar Laws

. This is a summary and may not be exhaustive. The policy language may contain additional exclusionary language, limitations or carve-backs that are not identified on the table. It is the responsibility of the Contractor/Subcontractor to review the policy for the complete details of all exclusions.

Special Conditions: **All wood frame only projects are subject to Protective Safeguards as shown in EXHIBIT C**

3. [EXCIBIT C](#).
4. Policy Term: The policy term is the term of the project.

## GENERAL CONDITIONS

- e. OCIP Policies Establish OCIP Coverage. The insurance coverages, limits of liability, definitions, terms, conditions, exclusions and limitations contemplated in these contractual provisions and the other contract documents are set forth in full in the OCIP insurance policies. The summary descriptions of such policies in these contractual provisions, in the Project Insurance Manual, or in any other contract document or elsewhere are not intended to be complete or to alter or amend any provisions of the actual OCIP policies. To the extent, if any, such descriptions herein or therein conflict with any such insurance policies, the provisions of the actual insurance policies shall govern. To the extent there are any other conflicts between or among the provisions of such insurance policies, these contractual provisions, the contract documents, or the Project Insurance Manual, then in descending order, the insurance policies shall govern, followed by these contractual provisions, the contract, the other contract documents, then the Project Insurance Manual. Contractor/Subcontractor acknowledges that it has had the opportunity to review the insurance policies as provided in [section 11.3](#), and that it is relying solely on the provisions set forth in the insurance policies, and not upon any oral or written statement or reference in these contractual provisions, any other contract document, the Project Insurance Manual, or otherwise.

### 11.4 OCIP Certificates and Policies

All Enrolled Contractors/Subcontractors will receive Certificates of Insurance for Workers' Compensation, General Liability, Excess Liability and Contractor's Pollution Liability coverages. Each enrolled Contractor/Subcontractor will receive their own Workers' Compensation policy. Program Administrator will provide a copy of the OCIP policies upon written request. Such policies or programs may be amended from time to time and the terms of such policies or programs, as they may be amended, are incorporated herein by reference. Contractors/Subcontractors hereby agree to be bound by the terms of coverage, as contained in such insurance policies and/or self-insurance programs.

### 11.5 Contractor/Subcontractor Responsibilities

Participation in the OCIP is mandatory but not automatic. Each Eligible Contractor /Subcontractor must comply with the following:

- a. Contractor Eligibility, see [Section 11.1](#), 11.1a for definition.
- b. Enrollment Compliance

An Eligible Contractor/Subcontractor is not enrolled until the Program Administrator and OCIP insurers receive and approve a completed *Contract Enrollment Form* (see EXHIBIT ), for each awarded contract. Enrollment is required prior to commencement of on-site activities but no contractor shall be enrolled sooner than 30 days prior to their start date. Evidence of Insurance for Contractor/Subcontractor-Provided Insurance Coverage (see Sections 11.7 and 11.8) is a requirement and must be submitted with the completed *Contract Enrollment Form*.

**Any Contractor/Subcontractor who enrolls in the OCIP after their start date must provide a No-Known-Loss Letter to the Program Administrator, along with the enrollment documentation. Late Enrollment is not guaranteed and must be approved and accepted by the insurance carrier.** Upon approval, the Program Administrator will provide evidence of OCIP coverage to the Contractor/Subcontractor, as noted in [Section 11.4](#).

All Contractors/Subcontractors shall cooperate with, and require their Subcontractors to cooperate with, the Owner and the Program Administrator, in regards to the administration and operation of the OCIP.

- c. Contractor/Subcontractor Compliance with Other Forms and Procedures



## **GENERAL CONDITIONS**

All Enrolled Contractors/Subcontractors are required to complete and submit the following forms:

### **1. Project Site Monthly Payroll Report**

Project Site Monthly Payroll Reports (see [EXHIBIT D](#)) must be submitted to the Program Administrator monthly, until the completion of the contract. This report must summarize the unburdened payroll by Workers' Compensation Class Code. Certified payroll is not a requirement of the OCIP and cannot be accepted. If the Project Site Monthly Payroll Report is not submitted to Program Administrator monthly, payment can be withheld until the report is received. Contractor/Subcontractor agrees to keep and maintain accurate and classified records of their payroll for operations at the Project Site. This payroll information is submitted to the OCIP insurer. A carrier audit may be performed using the reported payroll and other supporting documents, as required by the California Workers Compensation Insurance Rating Bureau (WCIRB).

#### **Workers' Compensation Insurance Rating Bureau Requirements**

*Once an Eligible Contractor/Subcontractor is enrolled into the OCIP, a separate Workers' Compensation Policy will be issued to them. All Enrolled Contractors/Subcontractors shall comply with the rules and regulations of the California Workers Compensation Insurance Rating Bureau (WCIRB).*

### **2. Contractor's Completion Notice**

*Contractor's Completion Notice* (see [EXHIBIT E](#)) must be submitted to the Program Administrator upon completion of work at the Project, which includes punch list items, but not warranty work. This form evidences all enrolled Contractors'/Subcontractors' actual start and completion dates, per each contract. This information is used to confirm that each Workers' Compensation Policy was issued with correct policy term dates, covering the Contractors/Subcontractors for the duration of their Work at the Project. This information is subsequently submitted to the Workers' Compensation Insurance Rating Bureau (WCIRB).

### **3. Project Insurance Manual**

*A Project Insurance Manual* will be provided to all awarded Contractors/Subcontractors, which includes a Program Summary, Claims Reporting Instructions, Project Safety Guidelines, necessary forms, and contact information. Copies can be requested from the Program Administrator.

### **Contractor/Subcontractor Compliance with all aspects of the OCIP**

All Contractors/Subcontractors further acknowledge and agree to comply fully and promptly with such safety, loss control, and quality control rules, requirements, and directives as may from time to time be promulgated by Owner, the Program Administrator and/or the OCIP insurers or any of its or their respective consultants, agents, or representatives. Nothing in this document or any other contract document or in the Project Insurance Manual, shall be deemed to render Owner or any of its affiliates of any tier an employer of Contractor/Subcontractor or any of its Subcontractors or any of its or their personnel or employees. Failure to comply will be considered non-performance under the contract.

It is the obligation of each Eligible Contractor/Subcontractor to enroll in the OCIP and to comply with all OCIP requirements set forth in these contractual provisions, in the OCIP insurance policies, in the Project Insurance Manual, and elsewhere in the contract documents. Contractor/Subcontractor shall provide each of its Subcontractors, among other things, with a copy of the Project Insurance Manual and a copy of these contractual provisions. Contractor/Subcontractor shall require in writing that each enrolling Subcontractor comply with, among other things, the provisions of the OCIP insurance policies, the Project Insurance Manual, and the contract documents. All such requirements shall be included in all subcontracts and sub-subcontracts with eligible parties. The failure of Contractor/Subcontractor or any other party to provide eligible Subcontractors with a copy of this document, the Project Insurance Manual, and/or all other applicable requirements shall not relieve any such Subcontractor of any of the obligations contained therein.

**GENERAL CONDITIONS**

Contractor/Subcontractor shall keep and maintain accurate records and information in accordance with the requirements of the OCIP Insurer(s), the Project Administrator, the Project Insurance Manual, and the contract documents, and shall provide such records and information to Owner, the Program Administrator, and/or the OCIP insurers upon request.

**11.6 OCIP Disclaimer**

The Owner does not warrant or represent that the OCIP coverages constitute an insurance program that completely addresses all the risks of the Contractors/Subcontractors. Prior to the commencement of work under the contract, it is the responsibility of all Contractors/Subcontractors to ensure that the OCIP coverages provided sufficiently address their insurance needs. Any additional insurance coverage purchased will be at Contractor’s/Subcontractor’s option and sole expense.

**11.7 Required Contractor/Subcontractor Provided Insurance Coverages**

For any work under this contract, and until completion and final acceptance of the work by the Owner, the Contractors/Subcontractors shall, at their own expense, promptly furnish Certificates of Insurance evidencing that coverage is in force and any required Additional Insured Endorsements to the Owner, with a copy to the Program Administrator for the following coverages, before commencing work on the Project.

- a. Automobile Liability Insurance Requirements and Limits Are as Follows: See Section 11.8 for Certificate Holder and Additional Insured Endorsement specifications. Automobile Liability Insurance must cover all vehicles owned by, hired by, or used on behalf of the Contractors/Subcontractors for both Project Site and off-site operations with the following minimum limits of liability:

Auto Liability Insurance Limits:

**Enrolled Contractors/Subcontractors**

General/Prime Contractor	Subcontractor	
\$2,000,000	\$1,000,000	Bodily Injury and Property Damage

Ineligible Contractors/Subcontractors – Not Enrolled

General/Prime Contractor	Subcontractor	
\$2,000,000	\$1,000,000	Bodily Injury and Property Damage

- b. Workers’ Compensation and Employer’s Liability Insurance Limits:

Workers’ Compensation –Statutory Benefits - All States

Employer’s Liability:

- \$1,000,000 Bodily Injury each Accident
- \$1,000,000 Bodily Injury by Disease – Policy Limit
- \$1,000,000 Bodily Injury by Disease – Each Employee

**GENERAL CONDITIONS**

c. General Liability Insurance, minimum limits of liability are as follows:

Eligible Contractors/Subcontractors

General/Prime Contractor	Subcontractor	
\$2,000,000	\$1,000,000	Bodily Injury and Property Damage
\$2,000,000	\$1,000,000	Per Occurrence
\$2,000,000	\$1,000,000	General Aggregate
\$2,000,000	\$1,000,000	Products/Completed Operations Aggregate
\$2,000,000	\$1,000,000	Personal/Advertising Injury Aggregate

Ineligible Contractors / Subcontractors – Not Enrolled

General/Prime Contractor	Subcontractor	
\$2,000,000	\$1,000,000	Bodily Injury and Property Damage
\$2,000,000	\$1,000,000	Per Occurrence
\$2,000,000	\$1,000,000	General Aggregate
\$2,000,000	\$1,000,000	Products/Completed Operations Aggregate
\$2,000,000	\$1,000,000	Personal/Advertising Injury Aggregate

d. Professional Liability Insurance: If Contractor’s/Subcontractor’s work requires design and/or design-assist services, or Contractor/Subcontractor performs professional services of any kind, Contractor/Subcontractor shall purchase and maintain, at its sole cost and expense, Professional Liability (Errors and Omissions) insurance for all professional services provided. This Professional Liability insurance shall include full prior acts coverage sufficient to cover the services under this agreement, with the following minimum limits of liability:

\$1,000,000 per Claim/Annual Aggregate

Deductible or self-insured retention amount must not be greater than \$100,000 per claim, including coverage of contractual liability.

Professional Liability Insurance is to be maintained during the term of the contract and for so long as the insurance is reasonably available as provided herein, for a period of ten (10) years after completion of the services.

e. Environmental and Asbestos Abatement Coverages: If the Contractor’s/Subcontractor’s scope of work involves the removal of asbestos, the removal/replacement of underground tanks, or the removal of toxic chemicals and substances, the Contractor/Subcontractor will be required to provide the following minimum limits of liability, for such exposures subject to requirements and approval of the Owner:

## **GENERAL CONDITIONS**

\$1,000,000 per Claim/Aggregate

- f. Aircraft or Watercraft Liability Insurance: If any Contractor/Subcontractor requires the use of Aircraft or Watercraft at the Project Site, the Contractor/Subcontractor shall purchase and maintain, or cause the operator of the Aircraft or Watercraft to purchase and maintain, Aircraft or Watercraft liability insurance. This must insure passengers and the General Public against personal injury, bodily injury or property damage arising out of the ownership, maintenance, use or entrustment to others. It includes Aircraft or Watercraft owned or operated by or rented or loaned to any insured. Use includes operation and "loading or unloading". Contractor/Subcontractor will be required to provide the following minimum limits of liability, for such exposures subject to requirements and approval of the Owner:

\$5,000,000 per Claim/Aggregate

### **11.8 Required Contractor/Subcontractor Certificates of Insurance and Additional Insured Endorsements**

Certificates of Insurance and Additional Insured Endorsements acceptable to the Owner and Program Administrator must be filed with the Owner within ten (10) days after award of the contract to all Contractors/Subcontractors and prior to commencement of on-site activities.

All required insurance shall be maintained, without interruption, from the date of commencement of on-site activities, until the date of the final payment or expiration of any extended period, as set forth in this agreement. These certificates and additional insured endorsements required by Section 11.7 and 11.8 shall provide not less than thirty (30) days prior written notice to the Owner, with a copy to the Program Administrator, of any material change in the insurance, cancellation, or non-renewal.

Certificates of Insurance, the Project must be identified on the Certificate of Insurance in the "Description of Operations/Locations/Vehicles/Special Items" section. The Certificates of Insurance should name District, as the Certificate Holder, as specified below:

#### **Certificate Holder: Liberty Union High School District**

c/o Statewide Educational Wrap Up Program (SEWUP)  
2355 Crenshaw Blvd., Suite 200  
Torrance, CA 90501

**Additional Insured Endorsements:** The Owner must be specifically named on the Schedule of an Additional Insured Endorsement, under the section titled, "Name of Person or Organization", as specified below:

1. All Contractors/Subcontractors must provide an additional insured endorsement for automobile liability.
2. Ineligible Contractors/Subcontractors must provide an additional insured endorsement on both the Automobile Liability and General Liability policies and a waiver of subrogation on workers' compensation.

#### **Liberty Union High School District**

c/o Statewide Educational Wrap Up Program (SEWUP)  
2355 Crenshaw Blvd., Suite 200  
Torrance, CA 90501

### **11.9 Contractor/Subcontractor Insurance for Personal Property and Equipment**

All Contractors/Subcontractors shall be solely responsible for any loss or damage to their personal property including, without limitation, their tools and equipment, mobile construction equipment, scaffolding, and temporary

## **GENERAL CONDITIONS**

structures, whether owned, borrowed, used, leased or rented by any Contractor/Subcontractor. Contractors/Subcontractors may at their sole discretion, purchase and maintain insurance or self-insure such equipment and property, and any deductible in relation thereto shall be their sole responsibility. Any insurance, including self-insurance, shall be the Contractors'/Subcontractors' sole source of recovery in the event of a loss.

Any type of insurance or any increase of limits of liability not described in this Section, which the Contractors/Subcontractors require for their own protection or on account of any statute, will be their own responsibility and at their expense.

### **11.10 Assignment of Return Premiums**

The Owner will be responsible for the payment of all premiums associated solely with the OCIP and will be the sole recipient of any dividend(s) and/or return premium(s) generated by the OCIP.

### **11.11 Waiver of Subrogation and Owner Indemnification**

With respect to their work on the Project:

1. Owner waives all rights of subrogation and recovery against the Contractors/Subcontractors to the extent of any loss or damage, which is insured under the OCIP.
2. Contractors/Subcontractors waive all rights of subrogation and recovery against the Owner and other Contractors/Subcontractors to the extent of any loss or damage, which is insured under the OCIP.
3. The Contractors/Subcontractors are obligated to indemnify the Owner for damages or claims not covered by the OCIP.

### **11.12 No Release**

The provision of the OCIP, by the Owner, will in no way be interpreted as relieving the Contractors/Subcontractors of any other responsibility or liability under this agreement or any applicable law, statute, regulation, or order.

### **11.13 Owner's Right to Audit**

The Contractor/Subcontractor will permit the Owner and/or its representative to examine and/or audit its books, records and insurance policy information. Contractor/Subcontractor will also provide any additional information to the Owner, or its appointed representatives, as may be required.

### **11.14 Duties in the Event of a Loss**

Contractors/Subcontractors are required to report all losses, which include potential losses, promptly to, OCIP insurers and/or Program Administrator. A full description and details of the incurred loss are also required.

The Contractor/Subcontractor shall assist the Owner, its agents, and the Program Administrator, by providing the utmost cooperation in the adjustment of claims arising out of the operations conducted under, or in connection with, the Project and shall cooperate with the Owner's insurers in claims and demands that arise out of the Work and that the insurers are called upon to adjust.

**In the event of an accident, it shall be the responsibility of the employing and/or responsible Contractor/Subcontractor to see that injured workers or members of the public are provided immediate medical treatment. All appropriate medical and claim forms must be filed in accordance with the claim procedures developed for this Project by Keenan & Associates, hereinafter called "Program Administrator." This includes notification to the appropriate state authorities, if necessary.**

### **11.15 Occupational Safety and Health Compliance**

All Contractors/Subcontractors are expected to comply with all applicable local, state, and federal occupational safety and health requirements. If additional safety and health requirements are set forth in the contract specifications, all contractors shall comply with these requirements.

## **GENERAL CONDITIONS**

It is the responsibility of each Contractor/Subcontractor to maintain an environment free of recognized hazards. All Contractors/Subcontractors shall exercise reasonable care to prevent work-related injuries; property and equipment damage at the Project, as well as minimize risk to the public and third party property.

The Program Administrator shall conduct periodic loss control surveys on behalf of the District. These surveys will focus on evaluating the Contractors'/Subcontractors' efforts to minimize loss, assist in identifying loss exposures, and to recommend appropriate corrective measures. The Program Administrator is a resource to supplement the safety and loss prevention activity of Contractors/Subcontractors. Its loss control survey activities or other activities of the Program Administrator and/or OCIP insurers do not in any way relieve the Contractors/Subcontractors of their responsibilities for Project safety.

### **11.16 Project Safety Program**

**In addition, local, state, and federal occupational safety and health laws, the following standards apply to all Enrolled and Non-Enrolled Contractors/Subcontractors.**

#### **a. Safety Orientation**

1. Contractor/Subcontractor employees shall be provided with a project specific safety orientation prior the start of the project. At a minimum, the orientation will address the following items:
  - a. The District's site safety requirements.
  - b. Site specific safety hazards and protective measures for these hazards.
  - c. Emergency telephone numbers and procedures.
  - d. Local medical clinic/hospital information within the Medical Provider Network (MPN).

#### **b. Program Management**

1. Each Contractor/Subcontractors shall have the following safety programs:
  - a. Injury and Illness Prevention Plans
  - b. Hazard Communication Programs
  - c. Heat Illness Prevention Plans
2. Each Contractor/Subcontractor shall have an onsite competent person responsible for occupational safety and health.

#### **c. Mandatory 6' Fall Protection**

1. Contractor/Subcontractor employees shall be protected from fall exposures of 6 feet or greater. Activities include but are not limited to:
  - a. Steel erection
  - b. Roofing
  - c. Framing
  - d. Decking
  - e. Scaffold work
  - f. Work performed from ladders
2. A safety monitor as means of fall protection is prohibited.
3. Ladder jacks, lean-to, and prop-scaffolds are prohibited.
4. Contractor/Subcontractors are required to provide training to their employees who might be exposed to a fall hazard prior to the exposure or upon hiring. This training shall be documented and available for review.
5. Methods of fall protection include but are not limited to the following:
  - a. Railings
  - b. Covers for Floor, Roof, and Wall Openings
  - c. Personal Fall Arrest Systems, Personal Fall Restraint Systems, and Positioning Devices
  - d. Controlled Access Zones
6. The design and construction of railings shall conform to the Cal/OSHA Construction Safety Orders.

## **GENERAL CONDITIONS**

7. The minimum parapet height allowed for fall protection is 42 inches or greater.
8. Covers used to cover floor, roof, and wall openings shall be secured in place to prevent accidental removal or displacement and shall be marked in accordance in accordance with Cal/OSHA Construction Safety Orders.
9. Covers used to cover floor and roof openings shall be capable of safely supporting the greater of 400 pounds or twice the weight of the employees, equipment and materials that may be imposed on any one square foot area of the cover at any time.
10. Controlled access zones shall be defined by a control line or other means that restricts access. Each line shall have a minimum breaking strength of 200 pounds. Signs shall be posted to warn unauthorized employees to stay out of the controlled access zone.
11. Control lines shall consist of ropes, wires, tapes, or equivalent materials. Control lines shall be erected and supported in accordance with Cal/OSHA Construction Safety Orders.

### **d. Site Safety**

According to industry practices, it is the responsibility of contractors of all tiers to exercise reasonable care to prevent work-related injuries; property and equipment damage at the project site, as well as minimize risk to the third-party persons and property. Contractors/Subcontractors of all tiers shall be expected to comply with the following safety and loss control requirements:

1. All Subcontractors shall identify their contact person(s) to the General or Prime Contractor.
2. All Contractors/Subcontractors shall follow District procedures for dealing with the media.
3. All construction employees shall wear clothing suitable for the weather and work conditions. At a minimum, this shall be short sleeved shirts, long pants, and leather or other protective work shoes or boots.
4. Alcohol is prohibited on District property always.
5. Contractors/Subcontractors will be required to respond to all District complaints about objectionable levels of dust or noise and will be required to provide prompt and appropriate abatement.
6. Construction personnel cannot enter District grounds other than the construction site unless accompanied by District personnel, and are allowed only “incidental” contact with students. Violations of these requirements by any construction employee will result in a mandatory background check of that employee – including fingerprinting – as required by state law.
7. All prime contractors must attend the site-specific pre-construction meeting.
8. No sexual reference or preference shall be permitted on any piece of clothing or the hardhat. Any employee observed disregarding this policy shall be removed from the job site until further notice.
9. All Contractors/Subcontractors shall control the break time activities of the employees to assure the cleanup of all soda cans, food wrappers, plastic bottles, or food containers from the break area. Such areas shall be cleaned immediately after the break and all waste placed in trash receptacles. No glass containers are permitted on the site.
10. Theft or willful damage to any property of the District, student, or other contractors will be prosecuted fully.
11. All Contractors/Subcontractors will advise non-English speaking employees in their native language either in a written format or via an interpreter of these policies.

### **e. Crane Safety**

## **GENERAL CONDITIONS**

1. In accordance with Title 8, California Code of Regulations, section 5006.1, employers shall only permit operators who have a valid certificate (license) of competency to operate cranes. The operator shall have his license on his person, readily available for review.
2. All cranes used in lifting service, exceeding 3 tons rated capacity, and their accessory gear shall not be used until the employer has ascertained that such equipment has been certificated in accordance with Cal/OSHA as evidenced by current and valid documents. Certificates (annual and quadrennial) attesting to current compliance with testing and examination standards shall be maintained, readily available for each crane.
3. The contractor shall provide an erection plan and procedure for erection of trusses and beams over 25 feet long. The erection plan and procedure shall be prepared by a civil engineer currently registered in California. This plan and procedure shall be followed and kept available on the job site.

f. Return to Work:

1. The District and OCIP Carrier are committed to working with all Enrolled Contractors and Subcontractors to promote the successful & timely return to work of injured employees following a work-related injury. The purpose of this policy is to ensure that Enrolled Contractor/Subcontractor employees who temporarily cannot return to their normal duties due to job-related injury or illness, but can safely perform transitional duties while recovering is offered appropriate transitional duties for a limited time only.
  - a. Each Enrolled Contractor/Subcontractor will cooperate with the OCIP Carrier to facilitate the return to work of any injured employee capable of safely performing transitional duties.
  - b. When the employee is released to transitional duties, it is the Enrolled Contractor/Subcontractor's responsibility to facilitate the injured employee's return to work.
  - c. The Enrolled Contractor/Subcontractor is expected to accommodate the injured employee and facilitate the return to work.
  - d. It will be the responsibility of the Insurance Carrier's Adjuster to maintain communication with the treating physician and the Enrolled Contractor/Subcontractor to facilitate the prompt return of an employee to full work status.

### **11.17 Owner's Insurance Obligations; Contractors'/Subcontractors' Obligations; Representations, Warranties and Disclaimers**

(a) Owner assumes no obligation to provide insurance other than that summarily described in these Contractual Provisions, in the Project Insurance Manual, and in the OCIP insurance policies. Contractor/Subcontractor shall review the OCIP coverages, limits of liability, and insurance policies to satisfy themselves that the coverages offered thereby meet its needs. Nothing contained herein shall be deemed to place any responsibility on Owner, and Owner disclaims any responsibility, for ensuring that the insurance provided by the OCIP is sufficient for the conduct of Contractor's/Subcontractor's business or performance of the Work, including, without limitation, the adequacy of the limits of liability provided by, and as to all other terms, conditions and exclusions of, the OCIP insurance policies. The furnishing of insurance by Owner through the OCIP shall in no way relieve or limit or be construed to relieve or limit Contractor/Subcontractor of any responsibility, liability or obligation imposed by the contract, the contract documents, the Project Insurance Manual, the OCIP insurance policies, or by law, including, without limitation, all indemnification obligations on the part of Contractor/Subcontractor.

(b) By enrolling in the OCIP, Contractor/Subcontractor acknowledge that (i) the limits of liability of the OCIP insurance policies are shared by all insured parties under the OCIP for this Project; (ii) Owner is not an insurer or in the business of insurance and is not an agent, broker, partner or guarantor of Contractor/Subcontractor or any of the insurance companies providing coverage under the OCIP (the "OCIP insurers"); and (iii) Owner is not responsible for (a) the availability, adequacy, or exhaustion of the limits of



## **GENERAL CONDITIONS**

the OCIP, (b) the present or future solvency of any of the OCIP insurers or (c) any claims or disputes by, between or among Owner, Contractor/Subcontractor and any of the OCIP insurers, including, without limitation, claims or disputes arising out of any the OCIP insurers' payment or nonpayment of claims or losses, or such insurers' contractual or extra-contractual duties, including, without limitation, defense and/or indemnity obligations. Any type of insurance coverage or limits of liability not provided by the OCIP which Contractor/Subcontractor desires for its own protection, or which is required by applicable laws or regulations, shall be its sole responsibility and expense and shall not be included in its compensation for the Work. If Contractor/Subcontractor believes that additional limits of liability beyond those provided by the OCIP would be prudent for its protection, it agrees to investigate and procure such additional limits of liability for itself at its sole cost.

(c) By enrolling in the OCIP, Contractor/Subcontractor represents and warrants that it has had the opportunity to read and analyze (and to obtain professional assistance to read and analyze) a copy of the OCIP insurance policies and understand the contents thereof. Any reference in these contractual provisions, in the Project Insurance Manual, or elsewhere in any contract document as to amount, nature, type or extent of coverage provided under the OCIP and/or potential applicability to any potential claim or loss is for reference only and Contractor/Subcontractor represents and warrants that it has not relied upon any such reference or any other oral or written statement by or on behalf of Owner, the Project Administrator, or any of its or their agents, employees or representatives, but solely upon its own independent review and analysis of the OCIP insurance policies in formulating any understanding and/or belief as to amount, nature, type or extent of any coverage, conditions, extensions, or limits of liability provided by and as to all other terms of the OCIP insurance policies and/or their potential applicability to any claim or loss or their sufficiency for the conduct of Contractor's/Subcontractor's business or performance under the contract documents. To the extent that Contractor/Subcontractor deems it prudent to secure and maintain additional, supplemental, excess, or wholly independent insurance or liability associated with its Work on the Project or otherwise, it shall be responsible to do so at its sole expense.

(d) Contractor/Subcontractor hereby releases Owner, the Program Administrator and their respective representatives, agents, directors, officers, employees, partners, shareholders, members, affiliates of every tier, successors, and assigns from any and all claims and liabilities arising out of or relating to acts, errors, omissions or negligence (i) in the design, selection, placement, adequacy, amount, limits, scope and nature of insurance coverage afforded by the OCIP, (ii) in the selection, performance and present and future solvency of the OCIP insurers, and (iii) in the implementation and administration of the OCIP. Contractor/Subcontractor shall make its own determinations regarding such matters and expressly waives all rights and benefits conferred upon it by the provisions of California Civil Code Section 1542, which provides:

*"A general release does not extend to claims which the creditor did not know or suspect to exist in his or her favor at the time of executing the release, which if known by him or her must have materially affected his or her settlement with the debtor."*

Contractor/Subcontractor expressly acknowledges that the foregoing waiver of the provisions of Section 1542 was separately bargained for, and expressly agrees that the release provision shall be given full force and effect, including, without limitation, as to unknown or unsuspected claims, demands, liabilities and causes of action, if any may exist or arise. This release provision shall survive the completion of the Work and the expiration or other termination of the Agreement.

## **GENERAL CONDITIONS**

### **11.18 Joint Defense of Claims and Suits Against More Than One Insured**

(a) If a claim, demand, suit, or other proceeding (“Claim”) is brought against more than one insured under the OCIP, Owner and Contractor/Subcontractor recognize the common interest of all OCIP insureds in jointly defending that Claim. To the fullest extent permitted by law, and absent a material, current, actual, unwaivable conflict of interest mandating the appointment of separate counsel under applicable law, Owner and Contractor/Subcontractor insured under the OCIP (i) shall be defended by the same counsel and by the same consultants and experts selected by Owner and/or the OCIP insurers at its or their sole discretion, regardless of whether the defense under the OCIP is provided subject to a reservation of rights issued by any OCIP insurer, and (ii) waive their respective rights to independent counsel as to any and all such Claims. This waiver is deemed to be continuing. Contractor/Subcontractor agrees to execute such other documents as are required to effectuate this waiver and fulfill the purpose of this Section 1.18.

(b) In defense of Claims arising under the OCIP, information shared with counsel engaged to defend the insureds (“Defense Counsel”) will be protected from disclosure and shall remain privileged even after the termination of the OCIP and/or the completion of the Project. Contractor/Subcontractor agrees not to disclose to any person or entity, other than to Owner and to Defense Counsel, any confidential information obtained in the defense or pursuit of Claims covered, or potentially covered, under the OCIP. Any such confidential information shall only be used in matters that arise directly pursuant to such OCIP Claims. However, disclosures of such confidential information may be made (i) upon written approval from Defense Counsel or (ii) where required by court order or by applicable law.

(c) Nothing in this Section 1.18 shall preclude Contractor/Subcontractors from engaging counsel of its choice, at its sole expense, to associate in the defense of any such Claim.

### **11.19 Duty of Care**

Nothing contained in the OCIP insurance policies, the contract, these contractual provisions, any other contract document, or the Project Insurance Manual shall relieve Contractor/Subcontractor of its obligations to exercise due care in the performance of its duties in connection with the Work and to complete the Work in strict compliance with the contract documents.

**NOTE: THE OWNER AND PROGRAM ADMINISTRATOR MUST APPROVE CHANGES TO ANY OCIP REQUIREMENT OR PROCEDURE. NO CONTRACTOR OR SUBCONTRACTOR HAS THE AUTHORITY TO AMEND THE OCIP REQUIREMENTS.**

# GENERAL CONDITIONS

Print Form  
Submit Form

[SEWUP@Keenan.com](mailto:SEWUP@Keenan.com)



- Initial Enrollment     Additional Contract  
 Change Order         Short term / T & M

## OCIP Contract Enrollment Form

Form must be completed by all Contractors/Subcontractors of all tiers for all initial/new contracts and any additional contracts and/or change orders for each project. If using subcontractors, you may use **OCIP Tools Online** to report each subcontractor or complete the "Expected Subcontractors" detail on the next page. **Parent Contractor is responsible for 100% subcontractor compliance with OCIP requirements as set forth in their contract and the SEWUP Project Insurance Manual.**

District: \_\_\_\_\_ Project: \_\_\_\_\_

### CONTRACTOR DETAILS

Contractor Legal Name: \_\_\_\_\_  Corporation     Sole Proprietor     Partnership     Joint Venture     LLC

DBA or Subsidiary: \_\_\_\_\_ FEIN#: \_\_\_\_\_ Contractor License #: \_\_\_\_\_

Business Address (Address as listed on Insureds Certificate): \_\_\_\_\_

Office Address (If Different from Business Address): \_\_\_\_\_

	Contact Name	Phone	Fax	Email
Main Enrollment Contact	_____	_____	_____	_____
Insurance Contact	_____	_____	_____	_____
Payroll Contact	_____	_____	_____	_____
Site Contact/Project Mgr.	_____	_____	_____	_____

### CONTRACT DETAILS

General/Prime Contractor     Subcontractor     Tier Subcontractor     Temp. Labor, Time & Material, or Other: \_\_\_\_\_ Bid Package #: \_\_\_\_\_

Awarding Contractor: \_\_\_\_\_ Prime Contractor: \_\_\_\_\_

Contract Value: \_\_\_\_\_ Self Performed Work: \_\_\_\_\_ %    \$ \_\_\_\_\_ Estimated Payroll: \_\_\_\_\_

Est. # of Subcontractors: \_\_\_\_\_ Subcontracted Work: \_\_\_\_\_ %    \$ \_\_\_\_\_

*If using subcontractors, please be sure to complete subcontractor information on next page*

Contract Award Date: \_\_\_\_\_ Est. Start Date: \_\_\_\_\_ Est. Completion Date: \_\_\_\_\_

Description of Work: \_\_\_\_\_

Off-Site Work Performed?     YES     NO    If Yes, Description of Off-site work: \_\_\_\_\_

### CONTRACTORS CURRENT INSURANCE INFORMATION

Insurance Broker or Agency: \_\_\_\_\_ Agent/Broker Contact: \_\_\_\_\_

Phone: \_\_\_\_\_ Fax: \_\_\_\_\_ Email: \_\_\_\_\_

### WORKERS COMPENSATION INSURANCE

Name of Insurer: \_\_\_\_\_ WC Policy #: \_\_\_\_\_ Bureau ID: \_\_\_\_\_

Effective From: \_\_\_\_\_ To: \_\_\_\_\_ Deductible / SIR: \_\_\_\_\_ Anniversary Rating Date: \_\_\_\_\_

### WORKERS COMPENSATION DETAILS (Estimated Project Site Payroll Only)

WC Class Code	WC Class Code Description	Rate	Est. Man Hours	Est. Payroll	Premium
		\$		\$	\$ 0
		\$		\$	\$ 0
		\$		\$	\$ 0
		\$		\$	\$ 0
Subtotals:				\$	\$ 0
Was Experience Modifier included in your above WC Class rate(s)? <input type="checkbox"/> YES <input type="checkbox"/> NO				Experience Modifier :    1	Modified Premium:    \$ 0
Attach Copies of Work Comp rate pages with enrollment form.				Plus/Minus Rate Deviations or Premium credits:	\$ 0
				(Cost A) Total Workers' Compensation Cost:	\$ 0

Keenan & Associates, 2355 Crenshaw Blvd., Ste. #200, Torrance, CA 90501, Attn: SEWUP, Phone (310) 212-0363, Fax (310) 787-8838, Email [SEWUP@keenan.com](mailto:SEWUP@keenan.com)  
License # 0451271

# GENERAL CONDITIONS



## OCIP Contract Enrollment Form

### GENERAL & EXCESS LIABILITY INSURANCE

General Liability Insurer \_\_\_\_\_ General Liability Policy #: \_\_\_\_\_  
 General Liability Effective From: \_\_\_\_\_ To: \_\_\_\_\_ General Liability Deductible: \_\_\_\_\_ or, Retention: \_\_\_\_\_  
 Excess Liability Insurer: \_\_\_\_\_ Excess Liability Policy #: \_\_\_\_\_ Effective From: \_\_\_\_\_ To: \_\_\_\_\_

### GENERAL & EXCESS LIABILITY INSURANCE DETAILS (Include Values related to this project contract)

Coverage	Classification Description	Based on Payroll, Receipts or Other	Rate	Per \$100 / \$1000 or Other	Total Value (Payroll, receipts, or Other)	Liability Premium
General Liability	1.		\$	\$	\$	\$
	2.		\$	\$	\$	\$
Excess/Umbrella Liability			\$	\$	\$	\$
					(Cost B) Total Liability Cost:	\$

Attach copies of GL and XL declarations and rate pages with enrollment form.

### TOTAL INSURANCE COST

(Cost C) Margin Factor (Apply your Mark-Up Against Current Cost): \$ \_\_\_\_\_  
 (Cost A + B + C) Total Insurance Cost: \$ \_\_\_\_\_

### EXPECTED SUBCONTRACTORS (If needed, please attach additional sheets including all information requested below.)

Company Name: \_\_\_\_\_ Contractor License #: \_\_\_\_\_ Est. Contract Value: \_\_\_\_\_  
 Scope of Work: \_\_\_\_\_ Est. Start Date: \_\_\_\_\_ Est. Completion Date: \_\_\_\_\_  
 Contact: \_\_\_\_\_ Phone: \_\_\_\_\_ Fax: \_\_\_\_\_ Email: \_\_\_\_\_

Company Name: \_\_\_\_\_ Contractor License #: \_\_\_\_\_ Est. Contract Value: \_\_\_\_\_  
 Scope of Work: \_\_\_\_\_ Est. Start Date: \_\_\_\_\_ Est. Completion Date: \_\_\_\_\_  
 Contact: \_\_\_\_\_ Phone: \_\_\_\_\_ Fax: \_\_\_\_\_ Email: \_\_\_\_\_

Company Name: \_\_\_\_\_ Contractor License #: \_\_\_\_\_ Est. Contract Value: \_\_\_\_\_  
 Scope of Work: \_\_\_\_\_ Est. Start Date: \_\_\_\_\_ Est. Completion Date: \_\_\_\_\_  
 Contact: \_\_\_\_\_ Phone: \_\_\_\_\_ Fax: \_\_\_\_\_ Email: \_\_\_\_\_

Company Name: \_\_\_\_\_ Contractor License #: \_\_\_\_\_ Est. Contract Value: \_\_\_\_\_  
 Scope of Work: \_\_\_\_\_ Est. Start Date: \_\_\_\_\_ Est. Completion Date: \_\_\_\_\_  
 Contact: \_\_\_\_\_ Phone: \_\_\_\_\_ Fax: \_\_\_\_\_ Email: \_\_\_\_\_

Company Name: \_\_\_\_\_ Contractor License #: \_\_\_\_\_ Est. Contract Value: \_\_\_\_\_  
 Scope of Work: \_\_\_\_\_ Est. Start Date: \_\_\_\_\_ Est. Completion Date: \_\_\_\_\_  
 Contact: \_\_\_\_\_ Phone: \_\_\_\_\_ Fax: \_\_\_\_\_ Email: \_\_\_\_\_

I DECLARE UNDER PENALTY OF PERJURY, UNDER THE LAWS OF THE STATE OF CALIFORNIA, THAT:  
 1. THE INFORMATION CONTAINED IN THIS DOCUMENT IS TRUE AND CORRECT.  
 2. I HEREBY UNDERSTAND THAT ENROLLMENT IS CONTINGENT UPON RECEIPT AND ACCEPTANCE OF THIS FORM AND ANY APPLICABLE CERTIFICATES OF INSURANCE. SHOULD I SUBMIT AN INCOMPLETE FORM, KEENAN'S SEWUP DEPARTMENT WILL CONTACT ME AND MY FIRM WILL NOT BE ENROLLED UNTIL I PROVIDE ALL NECESSARY INFORMATION IN ITS ENTIRETY.  
 3. I HAVE READ AND UNDERSTAND THE INFORMATION CONTAINED IN THE BID SPECIFICATIONS REGARDING THE INSURANCE COVERAGES PROVIDED THROUGH THE OCIP. MY FIRM UNDERSTANDS AND ACCEPTS THE INSURANCE PROVIDED UNDER THIS OCIP.  
 4. MY FIRM AGREES TO COMPLY WITH THE REQUIREMENTS OF THE OCIP AND FOLLOW THE ADMINISTRATIVE PROCEDURES AS OUTLINED IN THE BID SPECIFICATIONS

Signature: \_\_\_\_\_ Title: \_\_\_\_\_ Date: \_\_\_\_\_

Keenan & Associates, 2355 Crenshaw Blvd., Ste. #200, Torrance, CA 90501, Attn: SEWUP, Phone (310) 212-0363, Fax (310) 787-8838, Email SEWUP@keenan.com License # 0451271

## GENERAL CONDITIONS

### **EXHIBIT B**

<b>KNOWN OCIP POLICY EXCLUSIONS</b>	
<b><u>Workers Compensation</u></b>	<b><u>General Liability</u></b>
Bodily Injury Outside US or Canada	Aircraft, Auto or Watercraft
Bodily Injury To Any Member of Flying Crew	Asbestos
Bodily Injury To Person Subject To Federal Workers' Compensation	Certain Exclusions To Medical Payments Coverage
Bodily Injury To Person Subject To Occupational Disease Laws	Certain Exclusions To Personal and Advertising Injury Liability
Contractual Liability	Certified Acts of Terrorism
Employees Knowingly Employed Illegally	Contractual Liability (Limited Coverage Provided)
Employment Related Practices	Employers Liability
Intentional or Aggravated Bodily Injury	Employment Related Practices
Obligations Imposed By Disability Benefits or Any Similar Law	Expected or Intended Injury
Obligations Imposed By Occupational Disease Laws	Exterior Insulation and Finish Systems (EIFS) "Subject to Installation Requirements"
Obligations Imposed By Unemployment Compensation Laws	Fungi Or Bacteria
Obligations Imposed By Workers' Compensation Laws	Lead
State or Federal Law Violation Fines, Penalties	Mobile Equipment
<b><u>Builders Risk</u></b>	Nuclear
Asbestos	Personal and Advertising Bodily Injury
Certain Offsite Property	Pollution
Certain Release, Discharge, Escape, or Dispersal Of Contaminants	Prior Continuous, or Progressively Deteriorating Injury or Damage
Certified Acts of Terrorism (Can be added)	Professional Liability
Cessation of Work	Recall of Products, Work Or Impaired Property
Contractor's Tools, Machinery, Plans, Equipment	Silica or Silica Mixed Dust
Cost of Making Good	Violation of Statutes Governing Collecting, Transmitting Information
Damage To Existing Property (Can be added)	Violation of Statutes Governing Email, Fax, Phone Calls
Damage While Testing Prototype or Used Machinery/Equipment	War
Damages, Fines, Penalties At Government Agency or Court Order	Workers Compensation and Similar Laws
Disappearance or When Revealed By Inventory Shortage Alone	<b><u>Contractors Pollution Liability</u></b>
Earth Movement (Optional sublimits can be added)	Auto, Aircraft, Vessel Or Rolling Stock
Electrical, Magnetic, or Errors Related To Electronic Records	Claims Between Certain Insured's
Financial Accounts, Instruments, Stamps, Deeds, Precious Material	Contractual Liability
Flood (Optional sublimits can be added)	Damage To Property
Foreign Terrorism	Disposal Sites
Infidelity, Dishonesty, Fraudulent Activity Of Insured	Employment Related Practices
Land, Values of Land, Cut, & Fill etc. Prior to Project Commencement	Fines, Penalties, and Treble Damages
Loss Under Any Manufacturer or Supplier Guarantee/Warranty	Hazardous Materials Facility
Normal Subsidence	Intentional Acts
Nuclear	Nuclear
Offshore Or Barrier Island Property	Other Entities
Property That Stores, Processes, or Handles Radioactive Materials	Pre-Existing Conditions
Rolling Stock, Aircraft, Watercraft	Products
Software Loss, unless results from an Open Peril	Related Entities and Individuals
Standing Timber, Growing Crops, Animals	Transportation Of Pollutants
Vehicles or Equipment Licensed For Highway Use	War
War and Military Action	Workers Compensation and Similar Laws

### **EXHIBIT C**

## **GENERAL CONDITIONS**

### **PROTECTIVE SAFEGUARDS**

#### **APPLICABLE TO 'WOOD FRAME' PROJECTS ONLY:**

**The Builders Risk Policy will not pay for LOSS caused by or resulting from exposures, if the applicable protective safeguards are not maintained during the Builders Risk Policy term of INSURED PROJECT.**

**As a condition precedent to fire, theft, vandalism, and malicious mischief coverage provided by the Builders Risk Policy, the following protective safeguards will be maintained at every INSURED PROJECT site of Wood Frame construction insured by the Builders Risk Policy.**

- 1. Fencing - The entire INSURED PROJECT** site shall be surrounded with a six foot chain link fence suitably anchored in the ground and placed a reasonable distance from the insured property. Gates through the chain link fence shall be securely locked during non-working hours.
- 2. Lighting - The entire INSURED PROJECT** site shall be illuminated from sunset to sunrise, each day.

**GENERAL CONDITIONS**

**EXHIBIT D**

Save Form  
Print Form  
Submit Form



**PROJECT SITE MONTHLY PAYROLL REPORT**  
Due on the 10<sup>th</sup> of each month (for previous month labor)

District Name: \_\_\_\_\_ Bid Pkg. #: \_\_\_\_\_  
 Project Name: \_\_\_\_\_ REPORT # \_\_\_\_\_  
(For your Firm's use)  
 Reporting Month: \_\_\_\_\_ *Example Feb-2006*  
 Company Name: \_\_\_\_\_ Db Name: \_\_\_\_\_  
 Under Contract With: \_\_\_\_\_ SEWUP Site Code\*: \_\_\_\_\_

\*SEWUP Site Code can be found on Accident Claim Reporting Guide or Certificate of Insurance Issued for this project, under the Description of Operations section.

Workers' Compensation Class Code	Description	On-site man hours	Payroll*
TOTAL		0.00	\$0.00

**Is this your final payroll report?**  YES  NO  
 If Yes, submit final report with Contract Completion Notice. If this is not your final report, payroll must be submitted each month until contract work is complete. If there is no on site labor, 0 hours must be reported and submitted.

**I CERTIFY THAT THE INFORMATION REPORTED ABOVE IS TRUE AND ACCURATE. NOT REPORTING ACCURATE PAYROLL INFORMATION COULD AFFECT YOUR EXMOD - EXPERIENCE MODIFICATION RATING WITH THE WORKERS' COMPENSATION INSURANCE RATING BUREAU (WCIRB).**

Signature: \_\_\_\_\_ Title: \_\_\_\_\_

Print Name: \_\_\_\_\_ Date: \_\_\_\_\_

\*Only report payroll for work performed on-site. Do not include overtime wage rates, use straight time wage rates only, i.e., employee earns \$20/hr. and works 10 hours in one day, you would report \$200.00 (\$20.00 x 10). Payroll/remuneration that is taxable to employee and paid by your company, is reported to WCIRB.

Keenan & Associates  
 SEWUP Department  
 2355 Crenshaw Blvd., Ste. #200,  
 Torrance, CA 90501  
 Phone (310) 212-3344, Fax (310) 787-8838

[SUBMIT: SEWUP@KEENAN.COM](mailto:SUBMIT:SEWUP@KEENAN.COM)



v 090314

**GENERAL CONDITIONS**

**EXHIBIT E**

<input type="button" value="Save Form"/>	<input type="button" value="Submit Form"/>
 <a href="mailto:Sewup@keenan.com">Sewup@keenan.com</a>	
<b>Contractor's Completion Notice</b>	
District Name	
Project Name	
<b>IMPORTANT NOTIFICATION – PLEASE READ</b>	
<i>Contractor and Subcontractor agrees to complete this form and return to Keenan &amp; Associates upon completion or termination of work activities under this contract. Please include, with this form, any supporting documents for final contract value (if different from initial contract value).</i>	
Contractor/Subcontractor Legal Name:	
Contractor/Subcontractor dba Name:	
Address:	
Site Location Code/ Contract Number:	
Initial Contract Value: \$	
Final Contract Value: \$	
Start Date on Site:	
Last Day on Site*:	
<small>*This would include work performed on final closeout or punch-list items and should not include warranty work.</small>	
Parent Contractor (Company Name):	
Parent Contractor Contact Name (Print):	
Signature (Parent Contractor):	
Title:	
Date:	
Contractor/Subcontractor Contact Name (Print):	
Signature (Contractor/Subcontractor):	
Title:	
Date:	
<small>Keenan &amp; Associates SEWUP Department 2355 Crenshaw Blvd., Ste. #200, Phone (310) 212-3344, Fax (310) 767-8838 <a href="mailto:Sewup@keenan.com">Sewup@keenan.com</a> <a href="http://www.sewup.org">www.sewup.org</a> License No. 0451271</small>	
	



## **GENERAL CONDITIONS**

### **PERFORMANCE AND PAYMENT BONDS**

#### **11.20 BOND REQUIREMENTS**

Unless otherwise specified in the Supplemental Conditions, prior to commencing any portion of the Work, the Contractor shall furnish separate Payment and Performance Bonds for its portion of the Work which shall cover 100% faithful performance of and payment of all obligations arising under the Contract Documents and/or guaranteeing the payment in full of all claims for labor performed and materials supplied for the Work. All bonds shall be provided by a corporate Surety authorized and admitted to transact business in California as sureties.

To the extent, if any, that the Contract Price is increased in accordance with the Contract Documents, the Contractor shall, upon request of the District, cause the amount of the bonds to be increased accordingly and shall promptly deliver satisfactory evidence of such increase to the District. To the extent available, the bonds shall further provide that no change or alteration of the Contract Documents (including, without limitation, an increase in the Contract Price, as referred to above), extensions of time, or modifications of the time, terms, or conditions of payment to the Contractor will release the Surety. If the Contractor fails to furnish the required bonds, the District may terminate the Contract for cause.

##### **11.20.1 Surety Qualification**

Only bonds executed by admitted Surety insurers as defined in Code of Civil Procedure § 995.120 shall be accepted. Surety must be a California-admitted Surety and listed by the U.S. Treasury with a bonding capacity in excess of the Project cost.

##### **11.20.2 Alternate Surety Qualifications**

If a California-admitted Surety insurer issuing bonds does not meet these requirements, the insurer will be considered qualified if it is in conformance with § 995.660 of the California Code of Civil Procedure and proof of such is provided to the District.

## **GENERAL CONDITIONS**

### **ARTICLE 12 UNCOVERING AND CORRECTION OF WORK**

#### **12.1 COMPLIANCE WITH TITLE 24 INSTALLATION REQUIREMENTS**

Contractor is aware of the requirements governing Contractor's Work under title 24 Section 4-343 which provides, in pertinent part:

##### **4-343. Duties of the Contractor.**

(a) **Responsibilities.** It is the duty of the contractor to complete the Work covered by his or her contract in accordance with the approved Plans and Specifications therefore. The contractor in no way is relieved of any responsibility by the activities of the architect, engineer, Inspector or DSA in the performance of such duties.

(b) **Performance of the Work.** The contractor shall carefully study the approved Plans and Specifications and shall plan a schedule of operations well ahead of time. If at any time it is discovered that Work is being done which is not in accordance with the approved Plans and Specifications, the contractor shall correct the Work immediately. All inconsistencies or items which appear to be in error in the Plans and Specifications shall be promptly called to the attention of the architect or registered engineer, through the Inspector, for interpretation or correction. In no case, however, shall the instruction of the architect or registered engineer be construed to cause Work to be done which is not in conformity with the approved Plans, Specifications, and Change Orders. The contractor must notify the Project Inspector, in advance, of the commencement of construction of each and every aspect of the Work.

##### **12.1.1 Issuance of Notices of Non-Compliance**

The Inspector may issue a Notice of Non-Compliance on the Project indicating deviation from Plans and Specifications. It is Contractor's responsibility to correct all deviations from the approved Plans and Specifications unless the District has issued an Immediate Change Directive. In such case, the Contractor shall proceed with the Work with the understandings of the District as set forth in the WD and as specifically noted in Article 7.3.

#### **12.2 SPECIAL NOTICE OF AMERICAN'S WITH DISABILITIES ACT**

Some of the requirements in the Plans and Specifications are meant to comply with the Americans with Disabilities Act ("ADA"). The requirements of the ADA are technical in nature and may appear to be minor in nature (i.e. whether a walkway or ramp has a 2% cross-slope). Contractor is warned that even the slightest deviation from the specific requirements from the ADA is considered a Civil Rights violation and subjects the District to fines of three times actual damages sustained by a handicap individual or up to \$4,000 per violation and attorney's fees required to enforce the ADA violation. As a result of the significant liability and exposure associated with ADA aspects of the Contract, Contractor shall take special care to meet all ADA requirements detailed in the Plans and Specifications. Failure to comply with ADA rules that results in a Notice of Non-Compliance shall be repaired to meet ADA requirements promptly. In addition, any ADA violations that are not identified by Inspector or Architect that are later identified shall be repaired and charged back to the Contractor through a Deductive Change Order.

## **GENERAL CONDITIONS**

### 12.2.1 Indemnification of ADA Claims

Contractor shall indemnify, hold harmless and defend the District from ADA claims arising from the failure to comply with the Plans and Specifications. Further, any withholdings for ADA violations under Article 9.6 shall include potential redesign costs and an accelerated repair costs due to the potential for ADA claims arising from DSA posting of ADA violations on the Project.

## **12.3 UNCOVERING OF WORK**

### 12.3.1 Uncovering Work for Required Inspections

Work shall not be covered without the Inspector's review and the Architect's knowledge that the Work conforms with the requirements of the approved Plans and Specifications (except in the case of an ICD under Article 7.3). Inspector must be timely notified of inspections and of new areas so Work can be inspected at least 48 hours before opening a new area (For example, see DSA Form 156 for Commencement/Completion of Work Notification which requires "at least 48 hour" advance notification of a new area). An Inspector must comply with DSA protocols for signing each category or phase of Work under DSA Form 152 (in compliance with the Form 152 Manual) or a Notice of Deviation (DSA Form 154) will be issued requiring the Work that was not inspected be uncovered for inspection. Thus, if a portion of the Work is covered without inspection or Architect approval, is subject to a Notice of Non-Compliance for being undertaken without inspection, or otherwise not in compliance with the Contract Documents, after issuance of a Written Notice of Non-Compliance (Form 154) or a written notice to uncover Work, Contractor shall promptly uncover all Work (which includes furnishing all necessary facilities, labor, and material) for the Inspector's or the Architect's observation and such Work shall be replaced at the Contractor's expense without change in the Contract Sum or Time.

### 12.3.2 Costs for Inspections Not Required

If a portion of the Work has been covered is believed to be Non-Conforming to the Plans and Specifications, even if the Form 152 for the category of Work has been signed by the Inspector, the Inspector or the Architect may request to see such Work, and it shall be promptly uncovered by the Contractor. If such Work is in accordance with the Contract Documents, costs of uncover and replacement shall, by appropriate Change Order and shall, be charged to the District. If such Work is not in accordance with Contract Documents, the Contractor shall be responsible for all costs to uncover the Work, delays incurred to uncover the Work, and Contractor shall pay all costs to correct the Non-Conforming construction condition unless the condition was caused by the District or a separate contractor, in which event the District shall be responsible for payment of such costs to the Contractor.

## **12.4 CORRECTION OF WORK**

### 12.4.1 Correction of Rejected Work

The Contractor shall promptly correct the Work rejected by the Inspector or the District upon recommendation of the Architect as failing to conform to the requirements of the Contract Documents, whether observed before or after Completion and whether or not Fabricated, installed, or completed. The Contractor shall bear costs of correcting the rejected Work, including cost for delays that may be incurred by Contractor or Subcontractors, the cost for additional testing, inspections, and compensation for the Inspector's or the Architect's services and expenses made necessary thereby (including costs for preparing a CCD, DSA CCD review fees, and additional inspection and special inspection costs).

## **GENERAL CONDITIONS**

### **12.4.2 One-Year Warranty Corrections**

If, within one (1) year after the date of Completion of the Work or a designated portion thereof, or after the date for commencement of warranties established under Article 9.9.1, or by the terms of an applicable special warranty required by the Contract Documents, any of the Work is found to be not in accordance with the requirements of the Contract Documents, the Contractor shall correct it promptly after receipt of written notice from the District to do so unless the District has previously given the Contractor a written acceptance of such condition. This period of one (1) year shall be extended with respect to portions of the Work first performed after Completion by the period of time between Completion and the actual performance of the Work. This obligation under this Article 12.4.2 shall survive acceptance of the Work under the Contract and termination of the Contract. The District shall give such notice promptly after discovery of the condition.

### **12.4.3 District's Rights if Contractor Fails to Correct**

If the Contractor fails to correct nonconforming Work within a reasonable time, the District may correct the Work and seek a Deductive Change Order, pursuant to Article 9.6 or Article 2.2.

## **GENERAL CONDITIONS**

### **ARTICLE 13 MISCELLANEOUS PROVISIONS**

#### **13.1 GOVERNING LAW**

The Contract shall be governed by the law of the place where the Project is located.

#### **13.2 SUCCESSORS AND ASSIGNS**

The District and the Contractor respectively bind themselves, their partners, successors, assigns, and legal representatives to the other party hereto and to partners, successors, assigns, and legal representatives of such other party in respect to covenants, agreements, and obligations contained in the Contract Documents. Neither party to the Contract shall assign the Contract as a whole without written consent of the other. If either party attempts to make such an assignment without such consent, that party shall nevertheless remain legally responsible for all obligations under the Contract.

#### **13.3 WRITTEN NOTICE**

In the absence of specific notice requirements in the Contract Documents, written notice shall be deemed to have been duly served if delivered in person to the individual, member of the firm or entity, or to an officer of the corporation for which it was intended, or if delivered at or sent by registered or certified mail to the last business address known to the party giving notice.

#### **13.4 RIGHTS AND REMEDIES**

##### **13.4.1 Duties and Obligations Cumulative**

Duties and obligations imposed by the Contract Documents and rights and remedies available thereunder shall be in addition to and not a limitation of duties, obligations, rights, and remedies otherwise imposed or available by law.

##### **13.4.2 No Waiver**

No action or failure to act by the Inspector, the District, or the Architect shall constitute a waiver of a right or duty afforded them under the Contract Documents, nor shall such action or failure to act constitute approval of or acquiescence in a breach thereunder, except as may be specifically agreed in writing.

#### **13.5 TESTS AND INSPECTIONS**

##### **13.5.1 Compliance**

Tests, inspections, and approvals of portions of the Work required by the Contract Documents will comply with Division 1, Title 24, and with all other laws, ordinances, rules, regulations, or orders of public authorities having jurisdiction.

##### **13.5.2 Independent Testing Laboratory**

## **GENERAL CONDITIONS**

The District will select and pay an independent testing laboratory to conduct all tests and inspections. Selection of the materials required to be tested shall be made by the laboratory or the District's representative and not by the Contractor. See Articles 3.13.1 and 4.3.6 regarding costs or expenses of inspection or testing outside of the Project Site.

### 13.5.3 Advance Notice to Inspector

The Contractor shall notify the Inspector a sufficient time in advance of its readiness for required observation or inspection so that the Inspector may arrange for same. The Contractor shall notify the Inspector a sufficient time in advance of the manufacture of material to be supplied under the Contract Documents which must, by terms of the Contract Documents, be tested in order that the Inspector may arrange for the testing of the material at the source of supply.

### 13.5.4 Testing Off-Site

Any material shipped by the Contractor from the source of supply, prior to having satisfactorily passed such testing and inspection or prior to the receipt of notice from said Inspector that such testing and inspection will not be required, shall not be incorporated in the Work.

### 13.5.5 Additional Testing or Inspection

If the Inspector, the Architect, the District, or public authority having jurisdiction determines that portions of the Work require additional testing, inspection, or approval not included under Article 13.5.1, the Inspector will, upon written authorization from the District, make arrangements for such additional testing, inspection, or approval. The District shall bear such costs except as provided in Articles 13.5.6 and 13.5.7.

### 13.5.6 Costs for Retesting

If such procedures for testing, inspection, or approval under Articles 13.5.1 and 13.5.2 reveal failure of the portions of the Work to comply with requirements established by the Contract Documents, the Contractor shall bear all costs arising from such failure, including those of re-testing, re-inspection, or re-approval, including, but not limited to, compensation for the Architect's services and expenses. Any such costs shall be paid by the District, invoiced to the Contractor, and deducted from the next Progress Payment.

### 13.5.7 Costs for Premature Test

In the event the Contractor requests any test or inspection for the Project and is not completely ready for the inspection, the Contractor shall be invoiced by the District for all costs and expenses resulting from that testing or inspection, including, but not limited to, the Inspector's and Architect's fees and expenses, and the amount of the invoice shall be deducted from the next Progress Payment.

## 13.6 **TRENCH EXCAVATION**

### 13.6.1 Trenches Greater Than Five Feet

Pursuant to Labor Code section 6705, if the Contract Price exceeds \$25,000 and involves the excavation of any trench or trenches five (5) feet or more in depth, the Contractor shall, in advance of

## **GENERAL CONDITIONS**

excavation, submit to the District or a registered civil or structural engineer employed by the District or Architect, a detailed plan showing the design of shoring for protection from the hazard of caving ground during the excavation of such trench or trenches.

### 13.6.2 Excavation Safety

If such plan varies from the Shoring System Standards established by the Construction Safety Orders, the plan shall be prepared by a registered civil or structural engineer, but in no case shall such plan be less effective than that required by the Construction Safety Orders. No excavation of such trench or trenches shall be commenced until said plan has been accepted by the District or by the person to whom authority to accept has been delegated by the District.

### 13.6.3 No Tort Liability of District

Pursuant to Labor Code § 6705, nothing in this Article shall impose tort liability upon the District or any of its employees.

### 13.6.4 No Excavation without Permits

The Contractor shall not commence any excavation Work until it has secured all necessary permits including the required CAL OSHA excavation/shoring permit. Any permits shall be prominently displayed on the Site prior to the commencement of any excavation.

## 13.7 **WAGE RATES, TRAVEL, AND SUBSISTENCE**

### 13.7.1 Wage Rates

Pursuant to the provisions of Article 2 (commencing at § 1720), Chapter 1, Part 7, Division 2, of the Labor Code, the District has obtained the general prevailing rate of per diem wages and the general prevailing rate for holiday and overtime work in the locality in which this public works project is to be performed for each craft, classification, or type of worker needed for this Project from the Director of the Department of Industrial Relations (“Director”). These rates are on file at the administrative office of the District and are also available from the Director of the Department of Industrial Relations. Copies will be made available to any interested party on request. The Contractor shall post a copy of such wage rates at appropriate, conspicuous, weatherproof points at the Site.

Any worker employed to perform Work on the Project, but such Work is not covered by any classification listed in the published general prevailing wage rate determinations or per diem wages determined by the Director of the Department of Industrial Relations, shall be paid not less than the minimum rate of wages specified therein for the classification which most nearly corresponds to the employment of such person in such classification.

### 13.7.2 Holiday and Overtime Pay

Holiday and overtime work, when permitted by law, shall be paid for at the rate set forth in the prevailing wage rate determinations issued by the Director of the Department of Industrial Relations or at least one and one-half (1½) times the specified basic rate of per diem wages, plus employer payments, unless otherwise specified in the Contract Documents or authorized by law.

### 13.7.3 Wage Rates Not Affected by Subcontracts

## **GENERAL CONDITIONS**

The Contractor shall pay and shall cause to be paid each worker engaged in the execution of the Work on the Project not less than the general prevailing rate of per diem wages determined by the Director, regardless of any contractual relationship which may be alleged to exist between the Contractor or any Subcontractor and such workers.

### **12.4.4 Per Diem Wages**

The Contractor shall pay and shall cause to be paid to each worker needed to execute the Work on the Project per diem wages including, but not limited to, employer payments for health and welfare, pensions, vacation, travel time and subsistence pay as provided for in Labor Code §1773.1.

### **12.4.5 Forfeiture and Payments**

Pursuant to Labor Code §1775, the Contractor shall forfeit to the District, not more than Two Hundred Dollars (\$200.00) for each calendar day, or portion thereof, for each worker paid less than the prevailing wages rates as determined by the Director of the Department of Industrial Relations, for the work or craft in which the worker is employed for any Work done under the Agreement by the Contractor or by any Subcontractor under it. The amount of the penalty shall be determined by the Labor Commissioner and shall be based on consideration of: (1) whether the Contractor or Subcontractor's failure to pay the correct rate of per diem wages was a good faith mistake and, if so, the error was promptly and voluntarily correct upon being brought to the attention of the Contractor or Subcontractor; and (2) whether the Contractor or Subcontractor has a prior record of failing to meet its prevailing wage obligations.

### **12.4.6 Monitoring and Enforcement by Labor Commissioner**

Monitoring and enforcement of the prevailing wage laws and related requirements will be performed by the Labor Commissioner/ Department of Labor Standards Enforcement (DLSE). The Contractor and all subcontractors shall be required to furnish, at least monthly, certified payroll records directly to the Labor Commissioner in accordance with Labor Code section 1771.4. All payroll records shall be furnished in a format required by the Labor Commissioner. The Contractor and all subcontractors must sign up for, and utilize, the Labor Commissioner's electronic certified payroll records submission system. The District will have direct and immediate access to all CPRs for the Project that are submitted through the Labor Commissioner's system. The District can use this information for any appropriate purpose, including monitoring compliance, identifying suspected violations, and responding to Public Records Act requests.

The Labor Commissioner/ DLSE may conduct various compliance monitoring and enforcement activities including, but not limited to, confirming the accuracy of payroll records, conducting worker interviews, conducting audits, requiring submission of itemized statements prepared in accordance with Labor Code section 226, and conducting random in-person inspections of the Project site ("On-Site Visits"). On-Site Visits may include inspections of records, inspections of the Work site and observation of work activities, interviews of workers and others involved with the Project, and any other activities deemed necessary by the Labor Commissioner/DLSE to ensure compliance with prevailing wage requirements. The Labor Commissioner/DLSE shall have free access to any construction site or other place of labor and may obtain any information or statistics pertaining to the lawful duties of the Labor Commissioner/DLSE.

Any lawful activities conducted or any requests made by the Labor Commissioner/DLSE shall not be the basis for any delays, claims, costs, damages or liability of any kind against the District by the Contractor. Contractor and all subcontractors shall cooperate and comply with any lawful requests by



## **GENERAL CONDITIONS**

the Labor Commissioner/ DLSE. The failure of the Labor Commissioner, DLSE, or any other entity related to the Department of Industrial Relations to comply with any requirement imposed by the California Code of Regulations, Title 8, Chapter 8 shall not of itself constitute a defense to the failure to pay prevailing wages or to comply with any other obligation imposed by Division 2, Part 7, Chapter 1 of the Labor Code.

Prior to commencing any Work on the Project, the Contractor shall post the required notice/poster required under the California Code of Regulations and Labor Code section 1771.4 in both English and Spanish at a conspicuous, weatherproof area at the Project site. The required notice/poster is available on the Labor Commissioner's website.

### **13.8 RECORDS OF WAGES PAID**

#### **13.8.1.1 Payroll Records**

- a. Pursuant to §1776 of the Labor Code, the Contractor and each Subcontractor shall keep an accurate payroll record showing the name, address, social security number, work classification and straight time and overtime hours worked each day and week, and the actual per diem wages paid to each journeyman, apprentice, worker or other employee employed by him or her in connection with the Project.

All payroll records as specified in Labor Code §1776 of the Contractor and all Subcontractors shall be certified and furnished directly to the Labor Commissioner in accordance with Labor Code §1771.4(a)(3) on a monthly basis (or more frequently if required by the District or the Labor Commissioner) and in a format prescribed by the Labor Commissioner. Payroll records as specified in Labor Code §1776 shall be certified and submitted to the District with each application for payment. All payroll records shall be available for inspection at all reasonable hours at the principal office of the Contractor on the following basis:

A certified copy of an employee's payroll record shall be made available for inspection or furnished to the employee or his or her authorized representative on request.

A certified copy of all payroll records shall be made available for inspection or furnished upon request to a representative of District, the Division of Labor Standards Enforcement or the Division of Apprenticeship Standards of the Department of Industrial Relations.

A certified copy of all payroll records shall be made available upon request by the public for inspection or for copies thereof. However, a request by the public shall be made through the District, the Division of Apprenticeship Standards or the Division of Labor Standards Enforcement. If the requested payroll records have not been provided pursuant to Paragraph (2) above, the requesting party shall, prior to being provided the records, reimburse the costs, according to law for the preparation by the Contractor, Subcontractor(s), and the entity through which the request was made. The public shall not be given access to such records at the principal office of the Contractor.

The certified payroll records shall be on forms provided by the Division of Labor Standards Enforcement or shall contain the same information as the forms provided by the Division of Labor Standards Enforcement.

The Contractor or Subcontractor(s) shall file a certified copy of all payroll records with the entity that requested such records within 10 calendar days after receipt of a written request.

## **GENERAL CONDITIONS**

Any copy of records made available for inspection as copies and furnished upon request to the public or any public agency by the District, the Division of Apprenticeship Standards or the Division of Labor Standards Enforcement shall be marked or obliterated to prevent disclosure of an individual's name, address and social security number. The name and address of the Contractor awarded the Contract or the Subcontractor(s) performing the Contract shall not be marked or obliterated. Any copy of records made available for inspection by, or furnished to, a joint labor-management committee established pursuant to the federal Labor Management Cooperation Act of 1978 (Section 175a of Title 29 of the United States Code) shall be marked or obliterated only to prevent disclosure of an individual's name and social security number. Notwithstanding any other provision of law, agencies that are included in the Joint Enforcement Strike Force on the Underground Economy established pursuant to Section 329 of the Unemployment Insurance Code and other law enforcement agencies investigating violations of law shall, upon request, be provided non-redacted copies of certified payroll records.

The Contractor shall inform the District of the location of all payroll records, including the street address, city and county, and shall, within five working days, provide a notice of a change of location and address.

The Contractor or Subcontractor(s) shall have 10 calendar days in which to comply subsequent to receipt of a written notice requesting payroll records. In the event that the Contractor or Subcontractor(s) fails to comply within the 10-day period, the Contractor or Subcontractor(s) shall, as a penalty to the District, forfeit One Hundred Dollars (\$100.00) for each calendar day, or portion thereof, for each worker, until strict compliance is effectuated. Upon the request of the Division of Apprenticeship Standards or the Division of Labor Standards Enforcement, these penalties shall be withheld from progress payments then due.

Responsibility for compliance with this Article shall rest upon the Contractor.

### 13.8.2 Withholding of Contract Payments & Penalties

The District may withhold or delay contract payments to the Contractor and/or any Subcontractor if:

- a. The required prevailing rate of per diem wages determined by the Director of the Department of Industrial Relations is not paid to all workers employed on the Project; or

The Contractor or Subcontractor(s) fail to submit all required certified payroll records with each application for payment, but not less than once per month; or

The Contractor or Subcontractor(s) submit incomplete or inadequate payroll records; or

The Contractor or Subcontractor(s) fail to comply with the Labor Code requirements concerning apprentices; or

The Contractor or Subcontractor(s) fail to comply with any applicable state laws governing workers on public works projects.

### 13.9 APPRENTICES

#### 13.9.1 Apprentice Wages and Definitions

## GENERAL CONDITIONS

All apprentices employed by the Contractor to perform services under the Contract shall be paid the standard wage paid to apprentices under the regulations of the craft or trade for which he or she is employed, and as determined by the Director of the Department of Industrial Relations, and shall be employed only at the craft or trade to which he or she is registered. Only apprentices, as defined in §3077 of the Labor Code, who are in training under apprenticeship standards that have been approved by the Chief of the Division of Apprenticeship Standards and who are parties to written apprenticeship agreements under Chapter 4 (commencing with §3070) of Division 3, are eligible to be employed under this Contract. The employment and training of each apprentice shall be in accordance with the apprenticeship standards and apprentice agreements under which he or she is training, or in accordance with the rules and regulations of the California Apprenticeship Council.

### 13.9.2 Employment of Apprentices

Contractor agrees to comply with the requirements of Labor Code §1777.5. The Contractor awarded the Project, or any Subcontractor under him or her, when performing any of the Work under the Contract or subcontract, employs workers in any apprenticeable craft or trade, the Contractor and Subcontractor shall employ apprentices in the ratio set forth in Labor Code §1777.5. The Contractor or any Subcontractor must apply to any apprenticeship program in the craft or trade that can provide apprentices to the Project site for a certificate approving the contractor or subcontractor under the apprenticeship standards for the employment and training of apprentices in the area or industry affected. However, the decision of the apprenticeship program to approve or deny a certificate shall be subject to review by the Administrator of Apprenticeship. The apprenticeship program or programs, upon approving the Contractor or Subcontractor, shall arrange for the dispatch of apprentices to the Contractor or Subcontractor upon the Contractor's or Subcontractor's request. "Apprenticeable craft or trade" as used in this Article means a craft or trade determined as an apprenticeable occupation in accordance with the rules and regulations prescribed by the California Apprenticeship Council. The ratio of work performed by apprentices to journeyman employed in a particular craft or trade on the Project shall be in accordance with Labor Code §1777.5.

### 13.9.3 Submission of Contract Information

Prior to commencing Work on the Project, the Contractor and Subcontractors shall submit contract award information to the applicable apprenticeship program(s) that can supply apprentices to the Project and make the request for the dispatch of apprentices in accordance with the Labor Code. The information submitted shall include an estimate of journeyman hours to be performed under the Contract, the number of apprentices proposed to be employed, and the approximate dates the apprentices would be employed. A copy of this information shall also be submitted to the District if requested. Within 60 days after concluding Work on the Project, the Contractor and Subcontractors shall submit to the District, if requested, and to the apprenticeship program a verified statement of the journeyman and apprentice hours performed on the Project.

### 13.9.4 Apprentice Fund

The Contractor or any Subcontractor under him or her, who, in performing any of the Work under the Contract, employs journeymen or apprentices in any apprenticeable craft or trade shall contribute to the California Apprenticeship Council the same amount that the Director determines is the prevailing amount of apprenticeship training contributions in the area of the Project. The Contractor and Subcontractors may take as a credit for payments to the California Apprenticeship Council any amounts paid by the Contractor or Subcontractor to an approved apprenticeship program that can supply apprentices

## **GENERAL CONDITIONS**

to the Project. The Contractor and Subcontractors may add the amount of the contributions in computing his or her bid for the Contract.

### 13.9.5 Prime Contractor Compliance

The responsibility of compliance with Article 13 and §1777.5 of the Labor Code for all apprenticeable occupations is with the Prime Contractor. Any Contractor or Subcontractor that knowingly violates the provisions of this Article or Labor Code §1777.5 shall be subject to the penalties set forth in Labor Code §1777.7.

## 13.10 **ASSIGNMENT OF ANTITRUST CLAIMS**

### 13.10.1 Application

Pursuant to Government Code § 4551, in entering into a public works contract or a subcontract to supply goods, services, or materials pursuant to a public works contract, the Contractor or Subcontractor offers and agrees to assign to the District all rights, title, and interest in and to all causes of action it may have under Section 4 of the Clayton Act, (15 U.S.C. § 15) or under the Cartwright Act (Chapter 2 [commencing with § 16700] of Part 2 of Division 7 of the Business and Professions Code), arising from the purchase of goods, services, or materials pursuant to the public works contract or the subcontract. This assignment shall be made and become effective at the time the awarding body tenders Retention Payment to the Contractor, without further acknowledgment by the parties. If the District receives, either through judgment or settlement, a monetary recovery for a cause of action assigned under Chapter 11 (commencing with § 4550) of Division 5 of Title 1 of the Government Code, the assignor shall be entitled to receive reimbursement for actual legal costs incurred and may, upon demand, recover from the District any portion of the recovery, including treble damages, attributable to overcharges that were paid by the assignor but were not paid by the District as part of the bid price, less the expenses incurred in obtaining that portion of the recovery.

### 13.10.2 Assignment of Claim

Upon demand in writing by the assignor, the District shall, within one (1) year from such demand, reassign the cause of action assigned pursuant to this Article if the assignor has been or may have been injured by the violation of law for which the cause of action arose and the District has not been injured thereby or the District declines to file a court action for the cause of action.

## 13.11 **STATE AND DISTRICT CONDUCTED AUDITS**

Pursuant to and in accordance with the provisions of Government Code § 10532, or any amendments thereto, all books, records, and files of the District, the Contractor, or any Subcontractor connected with the performance of this Contract involving the expenditure of state funds in excess of Ten Thousand Dollars (\$10,000.00), including, but not limited to, the administration thereof, shall be subject to the examination and audit of the Office of the Auditor General of the State of California for a period of five (5) years after Retention Payment is made or a Notice of Completion is Recorded, whichever occurs first. Contractor shall preserve and cause to be preserved such books, records, hard drives, electronic media, and files for the audit period.

Pursuant to the remedies under Public Contract Code section 9201 and Government Code section 930.2, Contractor, through execution of this Agreement, also agrees the District shall have the right to review and audit, upon reasonable notice, the books and records of the Contractor concerning any monies

## **GENERAL CONDITIONS**

associated with the Project. The purpose of this “Audit” is to quickly and efficiently resolve Disputes based on the actual costs incurred and to reduce the uncertainty in resolving Disputes with limited information. The District shall perform any audits at its own cost and any such audit shall be performed by an independent auditor, having no direct or indirect relationship with the functions or activities being audited or with the business conducted by the Contractor or District. In the event the independent auditor determines that Change Orders, response to Request for Proposals, Claims, Appeal of Claims, or other requests for payment are in error, or have has any other concerns or questions, the Auditor shall report the results of the Audit findings to the District and provide a copy to the Contractor after giving the District Board the opportunity for at least 10 days review. If the Contractor disputes the findings of the independent auditor, such dispute shall be handled in the manner set forth under Article 4.6.2 entitled Disputes.

If Contractor having agreed to the terms of this Contract fails to produce books or records requested by Auditor, such failure to produce books or records that were required to be preserved for audit, it shall be presumed that the information contained in the withheld books or records were unfavorable to the Contractor and the Auditor shall note this refusal in the results of the Audit findings for further evaluation by the District and the District’s Board. The refusal to release records that are concerning monies associated with the Project may be used as a grounds to debar the Contractor under Article 15 for failure to preserve records under Article 13.11 and the failure to produce required audit records may also be used as a grounds for a negative finding against the Contractor depending on the significance of the records that are withheld by Contractor. Failure to produce job cost data tied to job cost categories and budgets shall be presumed an intentional failure to produce key audit records. Similarly, failure to produce Daily Reports (prepared at or near the time of the Work actually took place (See Article 3.16) shall be presumed an intentional failure to produce key audited records.

If Contractor is seeking costs for inefficiency, home office overhead, or unanticipated increased costs due to delays or acceleration, Contractor shall also produce copies of the original bid tabulation utilized in submitting Contractor’s bid for the Project. This document shall be considered confidential and shall not be subject to disclosure through a Public Records Act and shall not be distributed to anyone other than the District and the District’s counsel. This bid tabulation shall only be used in litigation, arbitration, evaluation of Claims or Disputes, Audit, and trial. If the records for the bid tabulation are kept on a computer, the Contractor shall also produce all metadata (in native format) that accompanies the bid tabulation for inspection to prove the authenticity of the underlying bid tabulation. Failure to produce the bid tabulation for review of inefficiency, home office overhead, or unanticipated increased costs due to delays or accelerations shall be considered material evidence that the bid tabulation was not favorable to the Contractor. This evidence shall be entered as a jury instruction for trial that the bid tabulation was not produced and the bid tabulation information was unfavorable to the Contractor. The evidence may also be used in debarment proceedings, and noted as an exception to an Audit findings.

Upon notification of Contractor concerning the results of the audit and a reasonable time has passed for Contractor to respond to the Audit findings and if either there is no Dispute of the Audit findings under Article 4.6 or if the result after utilizing the Disputes Clause confirms the Audit findings, the District may seek reimbursement for overstated Claims, Change Orders, or Appeal of Claims and may also undertake debarment proceedings under Article 15 of these General Conditions.

### **13.12 STORM WATER POLLUTION PREVENTION**

#### **13.12.1 Application**

This Section addresses the preparation, implementation and monitoring of a Storm Water Pollution Prevention Plan (SWPPP) for the purpose of preventing the discharge of pollutants from the

## GENERAL CONDITIONS

construction site. This includes the elimination of pollution discharges such as improper dumping, spills or leakage from storage tanks or transfer areas. The District will not issue a Notice to Proceed until Contractor has prepared by a qualified individual and obtained approval of the Permit Registration Documents ("PRDs") that include a Notice of Intent, Construction Risk Calculation, Site Map, SWPPP, Annual Fee and any additional required documents from all applicable Local Governing Agencies including the Regional Water Quality Control Board. The Contractor shall also secure a certification that the Project has met all of the conditions of the General Construction Activity Storm Water Permit (GCASP) and comply with all applicable local, state and federal regulations governing storm water pollution prevention.

### 13.12.2 References and Materials

- California Stormwater Quality Association New Development and Redevelopment Best Management Practice Handbook
- 2009 California Stormwater Quality Association Construction BMP Handbook .
- State Water Resources Control Board (2009). Order 2009-0009-DWQ, NPDES General Permit No. CAS000002: Waste Discharge Requirements for Discharges of Storm Water Runoff Associated with Construction and Land Disturbing Activities. Available on-line at:
- [http://www.waterboards.ca.gov/water\\_issues/programs/stormwater/construction.shtml](http://www.waterboards.ca.gov/water_issues/programs/stormwater/construction.shtml).- Use materials of a class, grade and type needed to meet the performance described in the BMP Handbook.

### 13.12.3 Preparation and Approval

The Contractor shall prepare by a qualified individual the PRDs that include a Notice of Intent, Construction Risk Calculation, Site Map, SWPPP, Annual Fee and any additional required documents. The Contractor's Qualified SWPPP Developer ("QSD") shall prepare the Storm Water Pollution Prevention Plan (SWPPP) as required to comply with storm water pollution regulations for project sites with storm water discharges associated with construction activity such as clearing or demolition, grading, excavation and other land disturbances. The SWPPP shall apply to all areas that are directly related to construction activity, including but not limited to staging areas, storage yards, material borrow areas, and access roads.

12.4.6.1 The Contractor shall prepare and submit to the Local Governing Agencies and the District the SWPPP for review and approval if the project sites, new or existing, with land disturbance of 1 or more acres (or less than 1 acres if part of a common plan of development); the construction activity that results in land surface disturbances of less than one acre is part of a larger common plan of development or sale of one or more acres of disturbed land surface; or the construction activity associated with Linear Underground/Overhead Projects ("LUPs") including, but not limited to, those activities necessary for the installation of underground and overhead linear facilities (e.g., conduits, substructures, pipelines, towers, poles, cables, wires, connectors, switching, regulating and transforming equipment and associated ancillary facilities) and include, but are not limited to, underground utility mark-out, potholing, concrete and asphalt cutting and removal, trenching, excavation, boring and drilling, access road and pole/tower pad and cable/wire pull station, substation construction, substructure installation, construction of tower footings and/or foundations, pole and tower installations, pipeline installations, welding, concrete and/or pavement repair or replacement, and stockpile/borrow locations.

## GENERAL CONDITIONS

12.4.6.2 The Contractor shall also pay annual renewal fee(s) until the contract is completed and make all such checks payable to the State Water Resources Control Board. The Notice of Intent must be submitted at least two weeks prior to the commencement of construction activities.

12.4.6.3 The Contractor shall prepare the SWPPP by following the format in Sections 2, 3, 4 and Appendices A through F of the California Stormwater BMP Handbook - Construction, January 2009 edition, published by the California Stormwater Quality Association. The publication is available from:

California Stormwater  
Quality Association  
P.O. Box 2105  
Menlo Park, CA 94026-2105  
Phone: (650) 366-1042  
E-mail: info@casqa.org

or

<https://www.casqa.org/store/products/tabid/154/p-167-construction-handbookportal-initial-subscription.aspx>

12.4.6.4 Where land disturbance is less than 1 acre, any BMPs indicated in the BMP Handbook needed to prevent or minimize storm water pollution shall be implemented at no extra cost to the District.

12.4.6.5 Within two weeks after Award of Contract by the District, the Contractor shall submit to the District's Civil Engineer one copy of the PRDs including the SWPPP for review. After the District's approval, the Contractor shall provide approved copies of the SWPPP as follows: one copy each to the Project Inspector, Construction Manager, Architect, Commissioned Architect and District's Civil Engineer.

### 13.12.4 Implementation

The Contractor shall implement the Storm Water Pollution Prevention Plan by doing the following:

- a. Obtain a Waste Discharger Identification (WDID) number from the SWRCB before beginning construction. This number will be issued once your PRDs are administratively accepted and fee is received.

Keep the SWPPP, REAPs, monitoring data on the construction site.

Employ a Qualified SWPPP Practitioner (QSP) to implement the SWPPP during construction and develop Rain Event Action Plans ("REAPs").

Install, inspect, maintain and monitor BMPs required by the General Permit.

Install perimeter controls prior to starting other construction work at the site.

Contain on-site storm water at the jobsite. Do not drain on-site water directly into the storm drain.

Implement the SWPPP.

## **GENERAL CONDITIONS**

Provide SWPPP and BMP implementation training for those responsible for implementing the SWPPP.

Designate trained personnel for the proper implementation of the SWPPP.

Conduct monitoring, as required, and assess compliance with the Numeric Action Levels (NALs) or Numeric Effluent Limitations (NELs) appropriate to your project.

Report monitoring data:

Maintain a paper or electronic copy of all required records for three years from the date generated or date submitted, whichever is last. These records must be available at the construction site until construction is completed.

Have a QSD revise the SWPPP as needed to reflect the phases of construction and to suit changing site conditions and instances when properly installed systems are ineffective.

Assist the District with entering any necessary data or information into the Stormwater Multi-Application and Reporting System ("SMARTS") system.

At the end of Construction Contract:

Submit Notice of Termination (NOT) into the SMARTS when construction is complete and conditions of termination listed in the NOT have been satisfied. A copy of the NOT can be found at: [http://www.waterboards.ca.gov/water\\_issues/programs/stormwater/construction.shtml](http://www.waterboards.ca.gov/water_issues/programs/stormwater/construction.shtml).

Leave in place storm water pollution prevention controls needed for post-construction storm water management and remove those that are not needed as determined by the District. Thereafter, left-in-place controls will be maintained by the District.

Provide Site Monitoring Reports, SWPPP revisions, Compliance Certifications and related documents to the District. Post-construction storm water operation and management plan as mentioned in the compliance certifications are considered to be in place at the end of the Construction Contract.

### 13.12.5 Monitoring

The Contractor shall conduct examination of storm water pollution prevention controls as required by the State Water Resources Control Board (2009). Order 2009-0009-DWQ, NPDES General Permit No. CAS000002: Waste Discharge Requirements for Discharges of Storm Water Runoff Associated with Construction and Land Disturbing Activities. This includes properly qualified personnel performing all required monitoring, testing, inspections and monitoring. The Contractor shall also conduct examination of storm water pollution prevention controls, as well as before and after each storm event in compliance with the State Water Resources Control Board Order No. 2009-0009-DWQ, National Pollutant Discharge Elimination System General Permit No. CAS000002, Waste Discharge Requirements for Discharges of Storm Water Runoff Associated with Construction and Land Disturbance Activities (General Permit) (SWRCB, 2009).and at least once each 24-hour period during extended storm events to identify BMP effectiveness and implement repairs or BMP changes as soon as feasible. All maintenance related to a storm event should be completed within 48 hours of the storm event. The Contractor shall also prepare and maintain, at the jobsite, a log of each inspection using Site Monitoring Report forms.



## **GENERAL CONDITIONS**

### 13.12.6 Liabilities and Penalties

Review of the SWPPP and inspection logs by the District shall not relieve the Contractor from liabilities arising from non-compliance with storm water pollution regulations.

Payment of penalties for non-compliance by the Contractor shall be the sole responsibility of the Contractor and will not be reimbursed by the District.

Compliance with the Clean Water Act pertaining to construction activity is the sole responsibility of the Contractor. For any fine(s) levied against the District due to non-compliance by the Contractor, the District will deduct from the final payment due the Contractor the total amount of the fine(s) levied on the District, plus legal and associated costs.

The Contractor shall submit to the District a completed NOI for change of information (Construction Site Information and Material Handling/Management Practices).

## **GENERAL CONDITIONS**

### **ARTICLE 14 TERMINATION OR SUSPENSION OF THE CONTRACT**

#### **14.1 TERMINATION BY THE CONTRACTOR FOR CAUSE**

##### **14.1.1 Grounds for Termination**

The Contractor may terminate the Contract if the Work is stopped for a period of thirty (30) consecutive days through no act or fault of the Contractor, a Subcontractor, a Sub-subcontractor, their agents or employees, or any other persons performing portions of the Work for whom the Contractor is contractually responsible, for only the following reasons:

- a. Issuance of an order of a court or other public authority having jurisdiction; or

12.4.6.5.1 An act of the United State or California government, such as a declaration of national emergency.

##### **14.1.2 Notice of Termination**

If one of the above reasons exists, the Contractor may, upon written notice of seven (7) additional days to the District, terminate the Contract and recover from the District payment for Work executed and for reasonable costs verified by the Architect with respect to materials, equipment, tools, construction equipment, and machinery, including reasonable overhead, profit, and damages.

#### **14.2 TERMINATION BY THE DISTRICT FOR CAUSE**

##### **14.2.1 Grounds for Termination**

The District may Z the Contractor and/or this Contract for the following reasons:

- a. Persistently or repeatedly refuses or fails to supply enough properly skilled workers or proper materials;

Persistently or repeatedly is absent, without excuse, from the job site;

Fails to make payment to Subcontractors, suppliers, materialmen, etc.;

Persistently disregards laws, ordinances, rules, regulations, or orders of a public authority having jurisdiction;

Fails to provide a schedule or fails or refuses to update schedules required under the Contract;

Falls behind on the Project and refuses or fails to undertake a Recovery Schedule;

If the Contractor has been debarred from performing Work

Becomes bankrupt or insolvent, including the filing of a general assignment for the benefit of creditors; or

## **GENERAL CONDITIONS**

Otherwise is in substantial breach of a provision of the Contract Documents.

### 14.2.2 Notification of Termination

When any of the above reasons exist, the District may, without prejudice to any other rights or remedies of the District and after giving the Contractor and the Contractor's Surety written notice of seven (7) days, terminate the Contractor and/or this Contract and may, subject to any prior rights of the Surety:

- a. Take possession of the Project and of all material, equipment, tools, and construction equipment and machinery thereon owned by the Contractor;

Accept assignment of Subcontracts. Contractor acknowledges and agrees that if the District (in its sole and absolute discretion) decides to takeover completion of the Project, the Contractor agrees to immediately assign all subcontracts to the District which the District has chosen to accept;

Complete the Work by any reasonable method the District may deem expedient, including contracting with a replacement contractor or contractors; and,

Agree to accept a takeover and completion arrangement with Surety that is acceptable to the District Board.

### 14.2.3 Takeover and Completion of Work after Termination for Cause

A Termination for Cause is an urgent matter which requires immediate radiation since Project Work is open and incomplete, the site is subject to vandalism and theft, the Project site is considered a public nuisance, and there is a possibility of injury and deterioration of the Project Work and materials. Thus, the District shall be entitled to enter a takeover contract to either remediate the unfinished condition or complete the Work for this Project.

### 14.2.4 Payments Withheld

If the District terminates the Contract for one of the reasons stated in Article 14.2.1, the Contractor shall not be entitled to receive further payment until the Work is complete. All costs associated with the termination and completion of the Project shall be the responsibility of the Contractor and/or its Surety.

### 14.2.5 Payments upon Completion

If the unpaid balance of the Contract Sum exceeds costs of completing the Work, including compensation for professional services and expenses made necessary thereby, such excess shall be paid to the Contractor. If such costs exceed the unpaid balance, the Contractor and its Surety shall pay the difference to the District. The amount to be paid to the Contractor, or District, as the case may be, shall be certified by the Architect upon application. This payment obligation shall survive completion of the Contract.

## 14.3 **TERMINATION OF CONTRACT BY DISTRICT (CONTRACTOR NOT AT FAULT)**

### 14.3.1 Termination for Convenience

## **GENERAL CONDITIONS**

District may terminate the Contract upon fifteen (15) calendar days of written notice to the Contractor and use any reasonable method the District deems expedient to complete the Project, including contracting with replacement contractor or contractors, if it is found that reasons beyond the control of either the District or Contractor make it impossible or against the District's interest to complete the Project. In such a case, the Contractor shall have no Claims against the District except for: (1) the actual cost for approved labor, materials, and services performed in accordance with the Contract Documents which have not otherwise been previously paid for and which are supported and documented through timesheets, invoices, receipts, or otherwise; and (2) profit and overhead of ten percent (10%) of the approved costs in item (1); and (3) termination cost of five percent (5%) of the approved costs in item (1). Contractor acknowledges and agrees that if the District (in its sole and absolute discretion) decides to takeover completion of the Project, the Contractor agrees to immediately assign all subcontracts to the District which the District has chosen to accept.

### **14.3.2 Non-Appropriation of Funds/ Insufficient Funds**

In the event that sufficient funds are not appropriated to complete the Project or the District determines that sufficient funds are not available to complete the Project, District may terminate or suspend the completion of the Project at any time by giving written notice to the Contractor. In the event that the District exercises this option, the District shall pay for any and all work and materials completed or delivered onto the site for which value is received, and the value of any and all work then in progress and orders actually placed which cannot be canceled up to the date of notice of termination. The value of work and materials not otherwise already paid for by the District up to the time of termination under this Paragraph shall include a factor of fifteen percent (15%) for the Contractor's overhead and profit and there shall be no other costs or expenses paid to Contractor. All work, materials and orders paid for pursuant to this provision shall become the property of the District. District may, without cause, order Contractor in writing to suspend, delay or interrupt the Project in whole or in part for such period of time as District may determine. Adjustment shall be made for increases in the cost of performance of the Agreement caused by suspense, delay or interruption.

### **14.4 REMEDIES OTHER THAN TERMINATION**

If a default occurs, the District may, without prejudice to any other right or remedy, including, without limitation, its right to terminate the Contract pursuant to Article 14.2, do any of the following:

- a. Permit the Contractor to continue under this Contract, but make good such deficiencies or complete the Contract by whatever method the District may deem expedient, and the cost and expense thereof shall be deducted from the Contract Price or paid by the Contractor to the District on demand;

If the workmanship performed by the Contractor is faulty or defective materials are provided, erected or installed, then the District may order the Contractor to remove the faulty workmanship or defective materials and to replace the same with work or materials that conform to the Contract Documents, in which event the Contractor, at its sole costs and expense, shall proceed in accordance with the District's order and complete the same within the time period given by the District in its notice to the Contractor; or

Initiate procedures to declare the Contractor a non-responsible bidder for a period of two (2) to five (5) years thereafter.

All amounts expended by the District in connection with the exercise of its rights hereunder shall accrue interest from the date expended until paid to the District at the maximum legal rate. The District

## **GENERAL CONDITIONS**

may retain or withhold any such amounts from the Contract Price. If the Contractor is ordered to replace any faulty workmanship or defective materials pursuant to Paragraph (b) above, the Contractor shall replace the same with new work or materials approved by the Architect and the District, and, at its own cost, shall repair or replace, in a manner and to the extent the Architect and the District shall direct, all Work or material that is damaged, injured or destroyed by the removal of said faulty workmanship or defective material, or by the replacement of the same with acceptable work or materials. In no event shall anything in this Article be deemed to constitute a waiver by the District of any other rights or remedies that it may have at law or in equity, it being acknowledged and agreed by the Contractor that the remedies set forth in this Article are in addition to, and not in lieu of, any other rights or remedies that the District may have at law or in equity.

## **GENERAL CONDITIONS**

### **ARTICLE 15 DEBARMENT**

#### **DEBARMENT MEANS THERE HAS BEEN A FINDING THAT THE CONTRACTOR IS NOT RESPONSIBLE.**

During the course of the Project, or if it is determined through Change Orders, Claims, or Audit that a Contractor is not responsible, the District may, in addition to other remedies provided in the Contract, debar the Contractor from bidding or proposing on, or being awarded, and/or performing work on District contracts for a specified period of time, which generally will not exceed five (5) years, but may exceed five (5) years or be permanent if the circumstances warrant such debarment. In addition to the debarment proceeding, a finding that a Contractor is to be debarred shall result in the termination of any or all existing Contracts the Contractor may have with the District.

#### **15.1 BOARD FINDING**

The District may debar a Contractor if the Board, or the Board's delegatee, in its discretion, finds the Contractor has done any of the following:

15.1.1 Intentionally or with reckless disregard, violated any term of the Contract with the District

15.1.2 Committed an acts or omission which reflects on the Contractor's quality, fitness or capacity to perform Work for the District;

15.1.3 Committed an act or offense which indicates a lack of business integrity or business honesty; or,

15.1.4 Made or submitted a false claim against the District or any other public entity.

#### **15.2 HEARING AND PRESENTATION OF EVIDENCE**

If there is evidence that the Contractor may be subject to debarment, the District shall notify the Contractor in writing of the evidence which is the basis for the proposed debarment and shall advise the Contractor of the scheduled date for a debarment hearing before the District Board or its delegated designee.

The District Board, or designee, shall conduct a hearing where evidence on the proposed debarment is presented. The Contractor or the Contractor's representative shall be given an opportunity to submit evidence at the hearing. The Contractor shall be provided an adequate amount of time to prepare and object to evidence presented. A tentative proposed decision shall be issued as a tentative decision and the District shall be entitled to modify, deny or adopt the proposed decision. The proposed decision shall contain a recommendation regarding whether the Contractor should be debarred, and, if so, the appropriate length of time of the debarment. The Contractor and the District shall be provided an opportunity to object to the tentative proposed decision for a period of 15 days. If additional evidence is presented, the District shall evaluate this evidence and either issue an amended ruling, issue the same ruling, or call a further hearing.

If a Contractor has been debarred for a period of longer than five (5) years, that Contractor may after the debarment has been in effect for at least five (5) years, submit a written request for review of the debarment determination to reduce the period of debarment or terminate the debarment. The District may, in its discretion, reduce the period of debarment or terminate the debarment if it finds that the Contractor

## **GENERAL CONDITIONS**

has adequately demonstrated one or more of the following: (1) elimination of the grounds for which the debarment was imposed; (2) a bona fide change in ownership or management; (3) material evidence discovered after debarment was imposed; or (4) any other reason that is in the best interests of the District.

The District will consider a request for review of a debarment determination only where: (1) the Contractor has been debarred for a period longer than five (5) years; (2) the debarment has been in effect for at least five (5) years; and (3) the request is in writing, states one or more of the grounds for reduction of the debarment period or termination of the debarment and includes supporting documentation. Upon receiving an appropriate request, the District will provide notice of the hearing on the request. At the hearing, the District shall review evidence on the proposed reduction of debarment period. This hearing shall be conducted and the request for review decided by the District pursuant to the same procedures as for a debarment hearing.

The District's proposed decision shall contain a recommendation on the request to reduce the period of debarment or terminate the debarment.

The terms shall also apply to Subcontractors of Contractor.

**SUPPLEMENTARY GENERAL CONDITIONS**

**CERTIFICATE OF SUBSTANTIAL COMPLETION**

PROJECT: \_\_\_\_\_

TO: \_\_\_\_\_

As the Architect for the Project described above, the Project has reached Substantial Completion. Substantial Completion is not reached unless and until each of the following three (3) conditions have been met: (1) all contractually required items have been installed with the exception of only minor and Incomplete Punch Items (See Article 9.9 of the General Conditions); (2) All Fire/Life Safety Systems have been installed, and are working and signed off on the DSA Form 152 Inspection Card, all building systems including mechanical, electrical and plumbing are all functioning; and (3) the Project is fit for occupancy and its intended use

I certify that the Project has reached Substantial Completion as defined above on the following date:  
\_\_\_\_\_.

\_\_\_\_\_  
Architect



## SUPPLEMENTARY GENERAL CONDITIONS

The following supplements modify the General Conditions. Where a portion of the General Conditions is modified and or deleted by these Supplementary Conditions, the unaltered portions of the General Conditions shall remain in effect.

### **ARTICLE 8 – TIME**

Article 8 Schedule Inclusion Requirements –The Baseline Schedule shall include the following Milestone Schedule:

#### **MILESTONE #1:**

Cafeteria Building and the surrounding site work area (the surrounding site work area as identified on the Milestone Plan) must be substantially complete within 260 calendar days of the Notice to Proceed. Substantial Completion includes all requirements for occupancy including but not limited to; full usage of the building for its intended use, operation of all MEP systems, ADA access compliance, completed and tested fire alarm system, and Contra Costa County Health Department approval of the kitchen for use. The Liquidated Damages amount for Milestone #1 is \$2,000 per calendar day. For each calendar day that the Cafeteria Building and the surrounding site work area do not meet the above noted milestone requirements the liquidated damage penalty amount per calendar day is \$2,000.00.

#### **MILESTONE #2:**

Administration and Student Services Building, surrounding site work area, and Southside Parking Lot area (the surrounding site work area and Southside Parking Lot area as identified on the Milestone Plan) must be substantially complete by June 2, 2022. The completion date of June 2, 2022 is based on a Notice To Proceed date of no later than February 28, 2021. Substantial Completion includes all requirements for occupancy including but not limited to; full usage of the building for its intended use, operation of all MEP systems, ADA access compliance, and completed and tested fire alarm system. Milestone #2 must be achieved in order for Milestone #3 to begin. The Liquidated Damages amount for Milestone #2 is \$2,000 per calendar day. For each calendar day that the Administration and Student Service Building, surrounding site work area, and Southside Parking Lot area do not meet the above noted milestone requirements the liquidated damage penalty amount per calendar day is \$2,000.00.

#### **MILESTONE #3:**

A-Wing Building must be substantially complete within 67 calendar days of the substantial completion of Milestone #2. Milestone #3 work can not commence any sooner than June 2, 2022, even if Milestone #2 is completed ahead of schedule. Substantial Completion includes all requirements for occupancy including but not limited to; full usage of the building for its intended use, operation of all MEP systems, ADA access compliance, and a complete and tested fire alarm system. The staff and furnishings currently housed in the A-Wing Building will be moved into the new Administration and Student Services Building at the substantial completion of Milestone #2, therefore Milestone #3 can not commence until Milestone #2 has reached substantial completion. The District will be responsible for the removal of the A-Wing furnishings from the A-Wing Building. The furnishings removal work will be completed within the initial 5 calendar days of the Milestone #3 67 calendar day duration. The Liquidated Damages amount for Milestone #3 is \$1,000 per calendar day. For each calendar day that the A-Wing Building does not meet the above noted milestone requirements the liquidated damage penalty amount per calendar day is \$1,000.00.

#### **MILESTONE #4:**

The remaining site work areas and Northside Parking Lot area (the remaining site work areas and Northside Parking Lot area as identified on the Milestone Plan) must be substantially complete by July 22, 2022. Milestone #4 work can not commence until June 2, 2022. Substantial Completion includes all

## **SUPPLEMENTARY GENERAL CONDITIONS**

requirements for usage including but not limited to; completion of all paving and hardscape, completion of all parking lot striping and signage and ADA striping and signage, and completion of irrigation and planting. The Liquidated Damages amount for Milestone #4 is \$1,000 per calendar day. For each calendar day that the remaining site work areas and Northside Parking Lot area does not meet the above noted milestone requirements the liquidated damage penalty amount per calendar day is \$1,000.00.

**DOCUMENT 00 7300**  
**SUPPLEMENTAL GENERAL CONDITIONS**

1.01 GENERAL

A. The conditions hereinafter specified shall apply to the performance of the Work of this project, the Contractor awarded the Work of the Project and all Subcontractors and Suppliers contracted or hired for the work of this Project and any other contractors the District may choose to hire for this Project.

B. All conditions set forth in Document 00 7200 - General Conditions, or any other portion of the Contract Documents, shall apply to the fullest extent except where they are in conflict with these Supplemental Conditions. In the event of such conflict, these Supplemental Conditions shall take precedence.

C. Governing Codes: Title 24, C.C.R.: A copy of Part I through Part V of California Title 24 shall be kept on the jobsite in the office of the Contractor's Project Superintendent.

D. All work performed under this contract shall comply in every respect to the rules and regulations of all agencies having jurisdiction for this classification of construction and design. These rules and regulations include California Code of Regulations, Title 24 and the latest edition of the National Electric Code.

E. Work shall not begin before nor more than one year after Division of State Architect (DSA) approval of plans and specifications per Title 24, Part I, Article 5, Section 4-330.

F. The School District shall have a DSA approved project inspector of record per Title 24, Part I, Article 5, Section 4-333. This inspector shall inspect every part of the work and shall make other notifications per Title 24, Part I, Section 4-342.

G. All required tests and inspections necessary to comply with statutory requirements shall be paid for by the District and reports shall be forwarded to DSA, the Architect, the Contractor and the Inspector of Record in accordance with Title 24, Part I, Section 4-335.

H. Semimonthly reports shall be submitted by the Inspector of Record to the Architect per Title 24, Part I, Section 4-337.

I. No changes or alterations of the approved plans and specifications shall be made without a DSA approved Construction Change Document in accordance with Title 24, Part I, Sections 4-343(c) and 4-336. All Addenda, change orders shall be approved by DSA per Section 4-338 (a). Any modification to DSA approved plans and specifications that affect structural safety, fire and life safety, access compliance or energy (as applicable) shall be submitted to the Division of State Architect for review and approval.

J. Supervision shall be performed by DSA in accordance with Title 24, Part I, Section 4-334.

K. Contractor(s) shall be required to submit regular and final Verified Report form DSA 6, current version. Contractor to provide copies of each submitted Verified Report to the Architect and the Division of State Architect. The duties of the Contractor under this contract shall be as enumerated in Part I, Title 24, C.C.R., Section 4-343.

L. Deferred approval items are indicated on the drawings. These items cannot be fabricated prior to DSA approval. Submission to DSA will not be permitted without prior approval of Architect. Contractor is hereby notified that it has the express responsibility for submission of shop drawings, submittals, product data and samples to DSA, as well as responsibility for obtaining DSA approval of deferred approval item.

M. Weekly job foreman / job superintendent meetings will be conducted by the Contractor to coordinate on-going construction issues. The Contractor shall require each subcontractor shall cause its designated job foreman or job superintendent to attend each coordination meeting, as scheduled by the Contractor.

N. The Contractor shall attend progress meetings as scheduled by the Architect for discussion of issues of administrative or design consideration with the District's Representative(s), the Inspector of Record and the Architect. The Contractor shall cause its project manager or project administrator to attend each progress meeting.

O. Division 1 of the Specifications further defines the intent of the General and Supplemental Conditions with respect to but not limited to: Summary of Work, Administrative Procedures, Definitions, Reference Standards, Quality Control, Temporary Facilities and Controls, Temporary Signage, Project Closeout. The requirements of Division 1 complement those of the Supplemental and General Conditions.

P. DSA is not subject to arbitration.

## 1.02 TESTING

A. To assist the District in the process of obtaining qualified and responsive quotations for testing and inspection services for the Project, Contractor shall submit with Contractor's baseline schedule, a schedule of required inspections and tests which includes the following information as a minimum:

- 1) Name of Special Inspection or Test;
- 2) Quantity or frequency of Special Inspections or Tests;
- 3) Projected Dates upon which Special Inspections and Tests are required.

B. The Contractor(s) shall furnish said schedule of required inspections and tests, based on the requirements of the Contract Documents, local regulatory codes and the Contractor's expertise in its field, at the same time required for submission of Contractor's Baseline Schedule in accordance with specification Section 01 3200. The District will provide all submitted schedules to the Testing Agency in accord with governing codes. The Contractor hereby acknowledges and agrees that, in the event additional testing and inspection costs are incurred due to failure of initial tests, cost for same shall be reimbursed to the Owner by the Contractor.

C. Testing will be performed by the Owner's Testing Agency in accordance with Title 24, Part I Section 4-335.

D. Special Inspection will be performed by the Owner's Testing Agency in accordance with Title 24, Part I Section 4-333 (c).

## 1.03 SURVEYING, LINES AND GRADES

A. Each Contractor awarded Work for this Project shall provide all necessary surveying, layout, lines and grades required for the proper location of the Work.

B. Contractor agrees to provide any and all false-work, templates, batter-boards and other such structures or devices necessary to provide for the Contractor's layout, lines and grades. Work installed in an incorrect location or elevation shall be removed and re-installed at the expense of the Contractor.

#### 1.04 FIRE MARSHAL REQUIREMENTS

A. Contractors must provide and maintain safe access for emergency vehicle traffic in accord with local fire marshal regulations.

#### 1.05 CONTRACT DOCUMENTS

A. The Owner will provide Initial Reprographic Costs requisite to provide the Contractor with at least two full sets of Contract Documents including any Addenda issued prior to Bid Submission Date. Contractors interested in additional sets may purchase them from the Printing Firm where the Contract Documents are on file at actual cost of reproduction.

B. Electronic copies of Contract Documents will be made available as described below.

C. No "conformed" sets of Contract Documents will be made available. The Contractor is responsible for reviewing and incorporating all addendum changes into the Contract Documents used by him for construction. All sums necessary for performance of this work shall be included in the Bid Proposal.

D. No reduced-size sets of Contract Documents will be made available.

E. Documents Valid at Full Size Only in Original Formats:

1. The Drawings, Specifications, or other documents prepared or supplied by Quattrocchi Kwok Architects for this project were prepared and intended to be prepared for viewing and use at the full original document sizes of 42 by 30 inches, 36 by 24 inches, 17 by 11 inches, and 8.5 by 11 inches, and that specifically, the line types / thicknesses, hatch patterns, textures, typeface designs, font sizes and any and all other forms of written or graphic communications and formats included therein were selected specifically by the authors of the documents to be read only at the full original document size.
2. Modifications such as enlargement, reduction, automated conversion, scanning and/or translation, or transition of information and data from the system and format used by Quattrocchi Kwok Architects to an alternate size, whether enlarged or reduced, or to another system format such as scanning to electronic format or media may result in the introduction of inexactitudes, anomalies and errors.
3. Modification of any of the Drawings, Specifications, or other documents or data prepared or supplied by Quattrocchi Kwok Architects, denotes assumption of all responsibility and risk for such errors and for the proper use of the modified document(s) by the modifying party.
4. Originals of all Drawings, Specifications or other documents and data prepared for this Project are originals retained by Quattrocchi Kwok Architects, and in whatever medium, shall be referred to and shall govern in the event of any inconsistency between them and any Drawings, Specifications, or other documents and data modified by any party.

F. Electronic Files shall be made available to the Contractor only following receipt of the attached QKA provided Electronic File Release Form signed by authorized representative of the Contractor attesting to agreement with terms of the release form. As stated in by the Electronic Release Form and represent above the files provided are a working product, may not fully conform to the Contract Documents and are utilized by the Contractor at Contractor's sole risk.

G. Contractor shall utilize web-resident data base administered through the Architect for construction clarifications, modifications and submittal review. Architect will provide required program training and access to Project data base. Further directions in regard to establishment and use of data base is found in corresponding Division 01 General Requirements.

#### 1.06 SUBSTITUTIONS

A. The materials, products, and equipment described in the Contract Documents establish a standard of required function, dimension, appearance, and quality. Architect may consider requests for substitutions of specified equipment, materials, or products and then only when requests are submitted in accordance with the provisions of the Contract Documents governing substitutions, and are received by Architect within the time period therein established. No substitutions will be considered after the date or receipt of the bid or contract award unless there is cause for a substitution which complies in every respect to the provisions of the Contract Documents governing substitutions. Refer to Division 01 Section specifying Product Requirements, for detailed instructions regarding substitution limitations and procedures.

#### 1.07 SCHEDULING

A. Submittal of monthly schedule updates are a condition precedent for processing of each Application for Progress Payment. Refer to the Division 01 Section specifying the Construction Schedule, for detailed instructions regarding scheduling requirements.

#### 1.08 FORCE ACCOUNT PROCEDURES

A. In the event the Contractor is required or authorized to perform work on a force account basis, in accord with the GENERAL CONDITIONS Article titled "Modifications of Contract", the Contractor shall comply with the following reporting requirements:

B. Contractor shall, at the end of each day during which Force Account work is performed, submit a detailed and complete time sheet or time card indicating total labor hours spent and classification, total equipment hours spent and classification, total materials and sales tax, and any other measurable costs associated with the performance of the work. The Contractor shall submit said time sheet to the Owner's Inspector and both parties shall sign the time sheet as evidence that both parties acknowledge and agree to the extent of the work performed. Failure on the part of the Contractor to comply with the foregoing procedures will be cause for the Contractor to forfeit any payment or claim for said Force Account work not signed for. The District and Contractor may, based upon mutual agreement, proceed with Force Account work on a Time and Materials basis, with total cost "not-to-exceed" any quotation tendered for said Force Account item(s).

#### 1.9 DISPUTED WORK PROCEDURES

A. The District may, in case of a disputed work item, direct the Contractor to perform the disputed work at no additional cost to the District, stating its belief that the work is clearly or adequately indicated in the Contract Documents, and therefore may be properly classified as an item for which prices are established in the Contract. In the event the Contractor maintains that the disputed work represents a modification to the Contract, Contractor may pursue reimbursement in accordance with Article titled RESOLUTION OF CONSTRUCTION CLAIMS of the General Conditions.

#### 1.10 CONFLICTS BETWEEN CONTRACTORS

A. Pursuant to Article 25 of the General Conditions, if Contractor is aware of a current or potential conflict between Contractor's work and the work of another Contractor on the site, and is unable to informally resolve the conflict directly with the other Contractor, Contractor shall promptly provide written notice to the District, with a copy to the Architect and the other Contractor, specifying the nature of the conflict, the date upon which the conflict arose, and the steps taken to attempt to resolve the conflict. The District shall issue written instructions to the involved Contractors to address the conflict

B. If Contractor is delayed in proceeding with its work or incurs additional cost, loss, or damage (collectively, "costs") due to another Contractor's negligence, delay, or failure to comply with the Contract or to comply with any written directive from the District or its authorized representatives, Contractor may seek compensation from the responsible Contractor by submitting a written request to the other Contractor, with a copy to the District and Architect, no later than thirty (30) days after the costs have been incurred, explaining the cause for the additional costs and including full documentation of the actual costs incurred. The other Contractor may provide a written response to the request, with a copy to the District and Contractor, within ten (10) days after receiving a copy of the request. The District shall evaluate the request for compensation and any response thereto and shall notify the involved Contractors in writing, within thirty (30) days following receipt of the request, of the District's determination of whether the Contractor is entitled to the requested compensation, in whole or in part. The District's determination shall be final. Contractor agrees to indemnify, defend, and hold harmless, to the full extent permitted by law, District and its Board of Trustees, officers, agents, Architect, and their employees and consultants from and against any and all liability, loss, damage, claims, expenses and costs arising from or related to Contractor's request for additional compensation pursuant to this Supplemental General Condition, including the District's determination.

C. If another Contractor is delayed in proceeding with its work or incurs additional costs, loss, or damage due to Contractor's negligence, delay, or failure to comply with the Contract or to comply with any written directive from the District or its authorized representatives, Contractor shall be responsible for all such additional cost, provided the other Contractor has submitted a written request for compensation, in accordance with the procedures set forth above, but only to the extent that the District determines that this Contractor is responsible for the other Contractor's costs, in whole or in part. If Contractor fails to compensate the other Contractor in the amount determined by the District within thirty (30) days following the District's determination, the District may, at its sole discretion, directly compensate the other Contractor and backcharge this Contractor for the full cost of such compensation.

#### 1.11 THIRD PARTY UTILITIES

A. Should the Contractor encounter a third party owned utility not shown or noted on the drawings, the Contract adjustment allowed the Contractor shall only be for the direct costs of removing, altering or relocating the utility, as needed, and an excusable, non-compensable time extension for the amount of time that such extra work affects the end date of the work. The Contractor shall not be entitled to damages or additional payment for delays attributable to such additional work as is required for removing, relocating, or altering utilities not shown or noted on the drawings. The Owner will not be entitled to assess liquidated damages for this amount of time.

1.12 ACCESS TO THE SITE

A. Contractor is notified that the Site is congested, with limited access. It shall be the Contractor's responsibility to coordinate Contractor's Work with the Work of other Prime Contractors performing work on the site. Areas designated by the Owner shall remain off-limits to construction personnel and equipment during construction.

END OF DOCUMENT

ELECTRONIC FILE RELEASE FORM FOLLOWS



0000.00-O-1.1



**Electronic Release Form**

**Contractor Contact**  
Contractor  
Address  
Address

**Project Name**

Project Number:  
DSA Application:  
DSA File:

Electronic files listed below will be sent to you, as allowed, upon receipt of a signed copy of this disclaimer.

The following applies to all information whatsoever, whether or not specifically identified below, which is being provided electronically.

Recipient understands and agrees that the information contained within these files is the internal working information of Quattrocchi Kwok Architects. Such internal working information is not intended as a finished product and may contain erroneous, extraneous, or incomplete information. All information contained on therein is preliminary and subject to change or correction without notice. Said information is furnished at the request of Recipient, for his sole convenience, and Recipient agrees to assume all responsibilities and risks of its use.

The Drawings, Specifications, or other documents prepared or supplied by Quattrocchi Kwok Architects for this project, whether in hard copy or machine readable form, are instruments of Quattrocchi Kwok Architects' service for one-time use solely with respect to this project. As such, they shall be deemed the property of Quattrocchi Kwok Architects who shall retain all common law, statutory and other reserved rights, including copyright. No Drawings, Specifications or other documents and data prepared or supplied by Quattrocchi Kwok Architects may be used on this project after Quattrocchi Kwok Architects' involvement is completed or on any other Project without Quattrocchi Kwok Architects' prior written consent.

Quattrocchi Kwok Architects reserves the right to retain originals of all Drawings, Specifications or other documents and data prepared under this agreement in whatever medium Quattrocchi Kwok Architects deems appropriate. Said originals retained by Quattrocchi Kwok Architects and in whatever medium, shall be referred to and shall govern in the event any inconsistency between them and any Drawings, Specifications, or other documents and data prepared or supplied to the Undersigned by Quattrocchi Kwok Architects. If the undersigned uses any of the Drawings, Specifications, or other documents or data prepared or supplied by Quattrocchi Kwok Architects, the undersigned assumes all responsibility and risk for the proper use thereof. For example, the Undersigned acknowledges that the automated conversion and/or transition of information and data from the system and format used by Quattrocchi Kwok Architects to an alternate system format may result in the introduction of inexactitudes, anomalies and errors.

The undersigned further understands that changes or modifications to the Drawings, Specifications, other documents or data prepared or supplied by Quattrocchi Kwok Architects made by anyone other than Quattrocchi Kwok Architects, including any such automated conversion and/or translation as described above, may result in adverse consequences which Quattrocchi Kwok Architects can neither predict nor control. Therefore, and in exchange for the Undersigned obtaining copies of the Drawings, Specifications, other documents or data prepared or supplied by Quattrocchi Kwok Architects, the Undersigned agrees that should the Undersigned, or any of its agents, modify or convert any of the Drawings, Specifications other documents or data prepared or supplied by Quattrocchi Kwok Architects, the Undersigned agrees to indemnify, defend, protect and hold Quattrocchi Kwok Architects harmless from and against any and all claims, liabilities, suits, demands, losses, costs and expenses, including reasonable attorney's fees, accruing or resulting to any and all persons, firms or any other legal entity, on account of any damage or loss to property or persons, including death, arising out of or in any way connected with, the modification or conversion of the Drawings, Specifications, other documents or data prepared or supplied by Quattrocchi Kwok Architects, whether in hard copy or machine readable form, except where Quattrocchi Kwok Architects is found to be solely liable for such damages or losses by a court or forum of competent jurisdiction. The foregoing indemnification applies, without limitation, to any modification or conversion of the Drawings, Specifications, other documents or data prepared or supplied by Quattrocchi Kwok Architects on other projects and for completion of, remodel of, or additions to this project.

**List of requested documents and/or data:**

Agreed to by CONTRACTOR:  
**Contractor Name**

By: \_\_\_\_\_

Date: \_\_\_\_\_

**SECTION 01 1100**

**SUMMARY OF WORK**

**PART 1 - GENERAL**

**1.01 SECTION INCLUDES**

- A. Work covered by Contract Documents.
- B. Work under separate contracts.
- C. Execution, correlation and intent.
- D. Acceptance of site.
- E. Related documents.
- F. Contractor's use of premises.
- G. Access.
- H. Existing conditions.

**1.02 WORK COVERED BY CONTRACT DOCUMENTS**

- A. Project name is:

**LIBERTY HIGH SCHOOL NEW ADMINISTRATION  
AND STUDENT COMMONS MODERNIZATION**

as shown on the Contract Documents prepared by Quattrocchi-Kwok Architects and briefly described as:

**LIBERTY HIGH SCHOOL:** Partial building demolition, site clearing, excavation, utilities, on-site and off-site improvement work including landscaping and site paving and construction of a new administration building and modernization of an existing student commons building

- B. The Work shall be constructed under single fixed-price Contract.
- C. The Work of the Contract includes but is not necessarily limited to:

1. Selective demolition, hazardous material abatement and construction necessary for the modernization of existing school building, including associated civil, architectural, structural, plumbing, mechanical and/or electrical work as indicated in the Drawings and Specifications. Generally these categories of work involve new finishes, adaptive re-use and modification of certain selected areas, accessibility modernization, and adding HVAC to instructional areas, library and administrative area and pertain to changing and expanding selected infrastructure utilities and extensive modifications. The Project will involve construction phasing and barricading of work areas as required to separate construction areas from occupied spaces and as needed to accommodate the Owner's schedule and use of the site.
2. All other work as shown in the Contract Documents.
3. The Work shall include all labor, materials and equipment necessary for the Contractor to fulfill all of its obligations pursuant to the Contract Documents, including but not limited to:
  - a. Home office overhead,
  - b. Off-Site supervision,
  - c. Project Administration including preparation, research and distribution of project correspondence and submittals,
  - d. Schedule preparation and maintenance,
  - e. Guarantys and warrantys,
  - f. On-Site supervision,
  - g. Temporary protection,
  - h. Temporary utilities and facilities, including mobilization and demobilization,
  - i. Material handling and storage,
  - j. Safety equipment,
  - k. Travel time to and from the Site to the Contractor's home office.
- D. Sequence the Work subject to the Owner's use of the site, the requirements of the Construction Phasing, Technical Specifications and the Contract provisions for Liquidated Damages found elsewhere in these documents.
- E. Perform work indicated or required to produce finished results shown.
- F. Contractor shall coordinate all work and shall be responsible for division of work among the various subcontractors.
  1. Coordinate the work of this Contract with the activities of the Owner, and with PG&E and other serving utilities.
  2. Coordinate the work of this Contract with the activities of the Owner's separate contractors, including those for removal or abatement of Hazardous Materials.
- G. Laws and Regulations: Intent of the Contract Documents is to construct the Work shown therein, in accordance with applicable codes and regulations.

### **1.03 WORK UNDER SEPARATE CONTRACTS**

- A. Serving Utilities may be performing certain utility work concurrent with this Contract.

### **1.04 EXECUTION, CORRELATION AND INTENT**

- A. Correlation and Intent
  1. Documents Complementary and Inclusive:

- a. The Contract Documents are complementary and are intended to include all items required for the proper execution and completion of the Work.
- b. Any item of work mentioned in the Specifications and not shown on the Drawings, or shown on the Drawings and not mentioned in the Specifications, shall be provided by Contractor as if shown or mentioned in both.
2. Coverage of the Drawings and Specifications:
  - a. The Drawings and Specifications generally describe the work to be performed by Contractor. Generally, the Specifications describe work which cannot be readily indicated on the Drawings and indicate types, qualities, and methods of installation of the various materials and equipment required for the Work.
  - b. It is not intended to mention every item of Work in the Specifications, which can be adequately shown on the Drawings, or to show on the Drawings all items of Work described or required by the Specifications even if they are of such nature that they could have been shown.
  - c. All materials or labor for Work, which is shown on either by the Drawings or the Specifications (or is reasonably inferable therefrom as being necessary to complete the Work), shall be provided by the Contractor whether or not the Work is expressly covered in either the Drawings and/or the Specifications.
  - d. It is intended that the Work be of sound, quality construction, and the Contractor shall be responsible for the inclusion of adequate amounts to cover installation of all items indicated, described, or implied in the portion of the Work to be performed by them.
3. Conflicts. In the event there is a discrepancy between the various Contract Documents, the Owner/Contractor Agreement shall control. Without limiting Contractor's obligation to identify conflicts for resolution by the Architect identified elsewhere in this Article it is intended that the more stringent, higher quality, and greater quantity of Work shall apply.
4. Conformance With Laws:
  - a. Each and every provision of law required by law to be inserted in this Contract shall be deemed to be inserted herein, and the Contract shall be read and enforced as though it were included herein, and if through mistake or otherwise any such provision is not inserted, or is not correctly inserted, then upon application of either party the Contract shall be amended in writing to make such insertion or correction.
  - b. Before commencing any portion of the Work, Contractor shall check and review the Contract Documents for such portion for conformance and compliance with all laws, ordinances, codes, rules and regulations of all governmental authorities and public utilities affecting the construction and operation of the physical plant of the Project, all quasi-governmental and other regulations affecting the construction and operation of the physical plant of the Project, and other special requirements, if any, designated in the Contract Documents.
  - c. In the event Contractor observes any violation of any law, ordinance, code, rule or regulation, or inconsistency with any such restrictions or special requirements of the Contract Documents, Contractor shall immediately notify Architect in writing of same and shall cause to be corrected any such violation or inconsistency in the manner provided hereunder.
5. Ambiguity:
  - a. Before commencing any portion of the Work, Contractor shall carefully examine all Drawings and Specifications and other information given to Contractor as to materials and methods of construction and other Project requirements.
  - b. Contractor shall immediately notify Owner and Architect of any perceived or alleged error, inconsistency, ambiguity, or lack of detail or explanation in the Drawings and Specifications in the manner provided herein.

- c. If the Contractor or its Subcontractors, material or equipment suppliers, or any of their officers, agents, and employees performs, permits, or causes the performance of any Work under the Contract Documents, which it knows or should have known to be in error, inconsistent, or ambiguous, or not sufficiently detailed or explained, Contractor shall bear any and all costs arising therefrom including, without limitation, the cost of correction thereof without increase or adjustment to the Contract Price or the time for performance.
  - d. If Contractor performs, permits, or causes the performance of any Work under the Contract Documents prepared by or on behalf of Contractor which is in error, inconsistent or ambiguous, or not sufficiently detailed or explained, Contractor shall bear any and all resulting costs, including, without limitation, the cost of correction, without increase to or adjustment in the Contract Price or the time for performance.
  - e. In no case shall any Subcontractor proceed with the Work if uncertain without the Contractor's written direction and/or approval.
- B. Addenda and Deferred Approvals
1. Addenda. Addenda shall govern over all other Contract Documents. Subsequent addenda issued shall govern over prior addenda only to the extent specified. In accordance with Title 24, California Code of Regulations, addenda shall be approved by the DSA.
  2. Deferred Approvals. The requirements approved by the DSA on any item submitted as a deferred approval in accordance with Title 24, California Code of Regulations, shall take precedence over any previously issued addenda, drawing or specification.
- C. Specification Interpretation and Application:
1. Titles. The Specifications are separated into titled sections for convenience only and not to dictate or determine the trade or craft involved.
  2. As Shown, Etc. Where "as shown," "as indicated," "as detailed," or words of similar import are used, reference is made to the Drawings accompanying the Specifications unless otherwise stated. Where "as directed," "as required," "as permitted," "as authorized," "as accepted," "as selected," or words of similar import are used, the direction, requirement, permission, authorization, approval, acceptance, or selection by Architect is intended unless otherwise stated.
  3. Provide. "Provide" means "provided complete in place," that is, furnished, installed, tested, and ready for operation and use.
  4. General Conditions. The General Conditions and supplementary general conditions are a part of each and every section of the Specifications.
  5. Abbreviations.
    - a. In the interest of brevity, the Specifications are generally written in an abbreviated form in the imperative tense and may not include complete sentences.
    - b. Omission of words or phrases such as "Contractor shall," "shall be," etc., are intentional. Nevertheless, the requirements of the Specifications are mandatory and directed to the Contractor.
    - c. Omitted words or phrases shall be supplied by inference in the same manner as they are when a "note" occurs on the Drawings.
  6. Plural. Words in the singular shall include the plural whenever applicable or the context so indicates.
  7. Metric. The Specifications may indicate metric units of measurement as a supplement to U.S. customary units. When indicated thus: 1" (25 mm), the U. S. customary unit is specific, and the metric unit is nonspecific. When not shown with parentheses, the unit is specific. The metric units correspond to the "International System of Units" (SI) and generally follow ASTM E 380, "Standard for Metric Practice."

8. Standard Specifications. Any reference to standard specifications of any society, institute, association, or governmental authority is a reference to the organization's standard specifications, which are in effect at the date of the Contractor's proposal.
  - a. If applicable specifications are revised prior to completion of any part of the Work, the Contractor may, if acceptable to Architect, perform such Work in accordance with the revised specifications.
  - b. The standard specifications, except as modified in the Specifications for the Project, shall have full force and effect as though printed in the Specifications. Architect will furnish, upon request, information as to how copies of the standard specifications referred to may be obtained.
  - c. Procurement of reference standards and standard specifications is the sole responsibility of the Contractor.
9. Absence of Modifiers. In the interest of brevity, the Contract Documents frequently omit modifying words such as "all" and "any" and articles such as "the" and "an," but the fact that a modifier or an article is absent from one statement and appears in another shall not affect the interpretation of either statement.

#### D. Rules of Document Interpretation

1. In the event of conflict or ambiguity within the drawings, the following rules shall apply:
  - a. General Notes, when identified as such, shall be incorporated into other portions of Drawings.
  - b. Schedules, when identified as such, are complementary with other notes and other portions of Drawings including those identified as General Notes.
  - c. Larger scale drawings shall take precedence over smaller scale drawings.
  - d. General or Typical Details and Symbols apply at all locations where specifically noted; at all locations conforming to the title of the Detail; at all locations of similar or identical graphic indication; at all locations where similar conditions are not fully or specifically shown or identified and complement similar details of specific conditions.
  - e. Details and Notes apply at all locations of similar or identical graphic indications and at all locations where similar conditions are not fully or specifically shown or identified.
  - f. Limitation of Indication does not affect Extent of Application: Indications of notes, details, and symbols may be limited to promote clarity. No limitation of application is intended nor shall be construed unless specifically noted.
  - g. Figured, derived, or numerical dimensions shall govern. At no time shall the Contractor base construction on scaled drawings.
2. Specifications shall govern as to materials, workmanship, and installation procedures.
3. In the case of disagreement or conflict between or within standards, specifications, and drawings, the more stringent, higher quality, and greater quantity of Work shall apply.

### 1.05 ACCEPTANCE OF SITE

- A. Contractor shall accept the site in the condition in which it exists at the time it is given Notice to Proceed.

### 1.06 RELATED DOCUMENTS

- A. The Drawings and general provisions of the Contract, including General and Supplementary Conditions and other Division 1 specifications apply to the Work of this Section.

### 1.07 CONTRACTOR'S USE OF PREMISES

- A. Confine operations on the site to areas indicated in the Contract Documents. Portions of the site beyond areas on which work is indicated are not to be disturbed. Conform to site rules and regulations affecting the Work while engaged in project construction.
- B. Contractor shall limit its use of the premises for work and storage to allow for work by other contractors.
- C. Maintain existing driveways and entrances serving the premises clear and available to the Owner and its employees at all times. Do not use these areas for parking or storage of materials.
- D. Do not unreasonably encumber the site with materials or equipment. Confine stockpiling of materials and location of storage sheds to area approved by the Architect. If additional storage is necessary, Contractor shall obtain and pay for such storage off site without additional expense to the Owner.
- E. Do not overload structures with weight that will endanger them.
- F. Assume full responsibility for protection and safekeeping of materials and tools stored at the site. Lock automotive type vehicles, such as passenger cars and trucks and other mechanized or motorized construction equipment, when parked and unattended, so as to prevent unauthorized use. Do not leave such vehicles or equipment unattended with the motor running or the ignition key in place.
- G. Move any stored products, temporary facilities, controls or fencing, under Contractor's control, which interfere with operations of the Owner or separate contractors, on or off the site, without cost to the Owner.
- H. Contractor shall cooperate with Owner and governing authorities to minimize disturbance. Observe all local ordinances for timing of work.
- I. In entrance and exit of all workmen and in bringing in, storing and removal of equipment, Contractor shall avoid unnecessary dust, mud or accumulated debris, or undue interference with the convenience, sanitation or routine of Owner's activities.
- J. In connecting new utilities to existing, and similar operations, Contractor shall time and coordinate such operations so that there will be no interference with Owner's activities.
- K. Protect improvements on adjoining properties as well as those on the Owner's property.
- L. Restore any improvements damaged by this work to their original condition as acceptable to the Owner.
- M. Do not interfere with use of adjacent buildings. Maintain free and safe passage to and from.
- N. Contractor shall be responsible for safety and support of structure. Cease operations and notify Architect immediately if safety of structure appears to be endangered. Take precautions to properly support structure. Do not resume operations until safety is restored. Contractor shall assume liability for such movement, settlement, damage or injury.

- O. Provide, erect and maintain barricades and guard rails as required by governing regulatory agencies to protect occupants of building and workers.
- P. Where demolition, removal or rework occurs, take all necessary precautions to protect existing finished work remaining in place from damage. Finished work damaged by operations under this contract shall be repaired or replaced to the satisfaction of Owner and Architect at no extra cost to the Owner.

#### 1.08 OWNER'S USE OF THE SITE

- A. Owner will remain in continuous occupancy of the site. Summer School, community use of athletic fields, after-hours Daycare and other site programs will be concurrent with this Contract. Owner reserves the right to limit hours of construction access and deliveries to avoid traffic conflicts during peak periods.
- B. Certain on and off-site work will be performed by others. A portion of this work, including the completion of preceding contracts, may be constructed concurrently with this Contract. The District will have various additional contracts for summer work and other projects from time-to-time on the site concurrent with this Contract.
- C. Portions of the regular class sessions may be concurrent with this Contract.
- D. Owner's Use of Concurrent or Related Contracts: The Owner may occupy certain portions of the work of other contracts listed above prior to the completion of the work of this Contract. Make all allowances and include all sums necessary in the Bid Proposal to accommodate the Owner's occupancy of these neighboring areas.

#### 1.09 ACCESS

- A. During the life of the Contract, maintain access to the site, and within the site to the building, for fire-fighting equipment, ambulance and police vehicles in accord with local fire marshal regulations.
  - 1. The Work of this Contract shall be performed, and such temporary facilities and phasing of activities provided, so as not to interfere with access to adjacent facilities or new work areas, so as to cause the least possible interference with activities of other contractors, the Owner's personnel or the public, and so as to protect persons and property from harm. Required accessways, and other accessways not required but so designated by the Owner or the Contract Documents, shall not be blocked.
  - 2. No utility service, such as water, gas, sewers, electricity, communication or fire protection system serving the project, or any part of it, shall be interrupted without prior written approval of the Owner.
- B. The DISTRICT has considered the totality of the circumstances concerning the Project and the CONTRACTOR and CONTRACTOR's employees (which includes Subcontractor employees) subjection to the FINGERPRINTING REQUIREMENTS of Education Code Section 45125.2. **Contractor shall comply with the determination regarding fingerprint certification as defined in the general conditions.**
- C. Contractor acknowledges that access to the project following occupancy by the Owner shall be subject to the requirements of Education Code Section 45125.2 as set forth in the General Conditions of the Contract and further acknowledges that all sums necessary to implement such compliance are included in the Bid Proposal.



- D. Contractor is notified that the Site is congested, with limited access. It shall be the Contractor's responsibility to coordinate Contractor's Work with the Work of other Prime Contractors performing work on the site. Areas designated by the Owner shall remain off-limits to construction personnel and equipment during construction.
- E. Contractor is hereby notified that the project site borders a residential neighborhood. Contractor acknowledges that the Work shall be performed during regular business hours. Contractor shall make provisions for the safety of residents and the general public adjacent to the site while working in proximity to the these areas or while working off-site.

#### **1.10 EXISTING CONDITIONS**

- A. Intent of the Drawings is to show existing conditions with information developed from field surveys and Owner's records, and to generally show the extent and type of work required to prepare the existing areas for new work. The information shown on the Drawings is not a guarantee of existing conditions.

#### **1.11 LIQUIDATED DAMAGES AND CONTRACT COMPLETION**

- A. Liquidated Damages will be assessed beginning on the Date contractually required for Completion and shall continue to accrue until each of the listed conditions are fulfilled.
- B. Date of Completion and Beneficial Occupancy is defined as the Date of Completion of all punch list items, including, but not limited to the following:
  - 1. Confirmation of mechanical and electrical systems testing and balancing, control sequences and operations.
  - 2. Completion of final cleaning, paint touch-up and adjusting.
  - 3. Adjustment and Contractor's certification of the finish hardware operation.
  - 4. Removal of Contractor's temporary facilities and materials.
  - 3. Owner's acceptance of the Work.
- C. Owner's occupancy prior to completion of any or all of the above items, or other such missing or incomplete work as may occur, shall not be construed as acceptance of the Work or as Completion when defined for the purposes of assessing Liquidated Damages.

#### **PART 2 - PRODUCTS**

Not Used.

#### **PART 3 - EXECUTION**

Not Used.

**END OF SECTION**

**SECTION 01 2600**  
**MODIFICATION PROCEDURES**

**PART 1 GENERAL**

**1.01 SECTION INCLUDES**

- A. Submittals.
- B. Documentation of change in Contract Sum and Contract Time.
- C. Change procedures.
- D. Execution of change orders.
- E. Correlation of Contractor submittals.

**1.02 RELATED SECTIONS**

- A. Document - Agreement: Monetary values of established Unit Prices.
- B. Document - General Conditions and Supplementary General Conditions: Governing requirements for changes in the Work, in Contract Sum and Contract Time and percentage allowances for Contractor's overhead and profit.
- C. Section 01 2900 - Applications for Payment: Payment applications and Schedule of Values.
- D. Section 01 3200 - Construction Progress Schedules: Work schedule.
- E. Section 01 6000 - Material and Equipment: Product options and substitutions.
- F. Section 01 7000 - Contract Closeout: Project record documents.

**1.03 SUBMITTALS**

- A. Submit name of the individual in Contractor's firm authorized to receive change documents, and be responsible for informing others in Contractor's employ or Subcontractors of changes to the Work.
- B. The following submittals shall be made on forms prepared by the Architect:
  - 1. Request For Information Forms.
  - 2. Architect's Supplemental Instructions Forms.
  - 3. Request For Proposal Forms.
  - 4. Change Order Forms.

**1.04 DOCUMENTATION OF CHANGE IN CONTRACT SUM AND CONTRACT TIME**

- A. Maintain detailed records of work done. Provide full information required for evaluation of proposed changes, and to substantiate costs of changes in the Work.
- B. Document each quotation for a change in cost or time with sufficient data to allow evaluation of the quotation.
- C. Provide additional data to support computations:
  - 1. Quantities of products, labor, and equipment.
  - 2. Taxes, insurance, and bonds.
  - 3. Overhead and profit.
  - 4. Justification for any change in Contract Time.
  - 5. Credit for deletions from Contract, similarly documented.

#### **1.05 REQUEST FOR INFORMATION ("RFI")**

- A. An RFI is a written request prepared by the Contractor asking the Architect to provide additional information necessary to clarify an item which the Contractor feels is not clearly shown or called for in the drawings or specifications, or to address questions which have arisen under field conditions.
  - 1. RFI's shall be submitted by the Contractor to the Architect on the form which is included in the project. Submittals not conforming to this requirement will be returned.
- B. The RFI shall reference all the applicable Contract Documents including specification section, detail, page numbers, drawing numbers, and sheet numbers, etc. The Contractor shall make suggestions and/or interpretations of the issue raised by the RFI. An RFI cannot modify the Contract Cost, Contract Time, or the Contract Documents.
- C. The Architect must respond to a RFI within fourteen (14) calendar days after receiving such request. If the Architect cannot respond to the RFI within fourteen (14) calendar days, the Architect shall notify the Contractor, with a copy to the Inspector and the Owner, of the amount of time that will be required to respond.
- D. The Contractor shall be invoiced by the Owner for any costs incurred for professional services, which shall be deducted from the next progress payment, if an RFI requests an interpretation or decision of a matter where the information sought is equally available to the party making such request.

#### **1.06 ARCHITECT'S SUPPLEMENTAL INSTRUCTIONS ("ASI")**

- A. An ASI is a written supplemental instruction issued and signed by the Architect for minor changes to the Work, without change in Contract Sum or Contract Time.
- B. Architect Authority;
  - 1. The Architect will have authority to order minor changes in the Work not involving any adjustment in the Contract Sum, an extension of the Contract Time, or a change which is inconsistent with the intent of the Contract Documents.
  - 2. Such changes shall be effected by written Change Order and shall be binding on the Owner and the Contractor. The Contractor shall carry out such written orders promptly.

**1.07 REQUEST FOR PROPOSAL ("RFP")**

- A. An RFP is a written request prepared by the Architect asking the Contractor to submit to the Owner and the Architect an estimate of the effect of a proposed change on the Contract Price and the Contract Time.
- B. An RFP shall contain adequate information, including any necessary drawings and specifications, to enable Contractor to provide the cost breakdowns.
- C. Owner or Architect may initiate changes by submitting a proposal request to Contractor. Request will include:
  - 1. Detailed description of the change, products and location of the change in the project.
  - 2. Supplementary or revised drawings and specifications.
  - 3. The projected time span for making the change and a specific statement as to whether overtime work is, or is not, authorized.
  - 4. A specific period of time during which the requested price will be considered valid.
  - 5. Such request is for information only and is not an instruction to execute the changes nor to stop work in progress.
- D. The Contractor shall not be entitled to any Additional Compensation for preparing a response to an RFP, whether ultimately accepted or not.

**1.08 CHANGE ORDER REQUEST ("COR")**

- A. Definition: A COR is a written request prepared by the Contractor asking the Owner and the Architect to incorporate a proposed change called for in an RFP or a claim into a Change Order.
- B. Changes in Price: Include breakdowns as required in the Article for FORMAT FOR CHANGE ORDER REQUEST to validate any change in Contract Price due to proposed change or claim.
- C. Changes in Time: A COR shall also include any additional time required to complete the Project. Any additional time requested shall not be the number of days to make the proposed change, but must be based upon the impact to the Project Schedule as defined in the General Conditions and Division 1 of the Specifications.
- D. Scope of Costs: Within ten (10) days or such lesser period of time as may be required by Owner after a request is made for a change that impacts the Contract Sum or the Contract Time, provide to the Owner and the Architect in writing an estimate of the effect of the proposed Change upon the Contract Price and the actual cost of construction, which shall include a complete itemized cost breakdown of all labor and material showing the following required for the change: actual quantities and unit prices of materials, labor hours, wage rates, the effect upon the Contract Time of such Change.
- E. Determination of Cost: The amount of the increase or decrease in the Contract Price resulting from a CO, if any, shall be determined in one or more of the following ways as applicable to a specific situation:
  - 1. Mutual acceptance of a lump sum properly itemized and supported by sufficient substantiating data to permit evaluation;

2. Unit prices stated in the Contractor's original bid, the Contract Documents, or subsequently agreed upon between the Owner and the Contractor;
  3. Cost to be determined in a manner agreed upon by the parties and a mutually acceptable fixed or percentage fee; or
  4. By cost of material and labor and percentage of overhead and profit.
- F. Determination of Costs by Material and labor and Percentage of overhead and profit: If the value is determined by this method the following requirements shall apply:
1. Daily Reports by Contractor.
    - a. General: At the close of each working day, the Contractor shall submit a daily report to the Inspector, on forms approved by the Owner, together with applicable delivery tickets, listing all labor, materials, and equipment involved for that day, the location of the Work, and for other services and expenditures when authorized concerning extra work items. An attempt shall be made to reconcile the report daily, and it shall be signed by the Inspector and the Contractor. In the event of disagreement, pertinent notes shall be entered by each party to explain points which cannot be resolved immediately. Each party shall retain a signed copy of the report. Reports by subcontractors or others shall be submitted through the Contractor.
    - b. Labor: Show names of workers, classifications, and hours worked.
    - c. Materials: Describe and list quantities of materials used.
    - d. Equipment: Show type of equipment, size, identification number, and hours of operation, including, if applicable, loading and transportation.
    - e. Other Services and Expenditures: Describe in such detail as the Owner may require.
- G. Basis for Establishing Costs for Change Orders:
1. Labor will be the actual cost for wages prevailing locally for each craft or type of workers at the time the extra work is done, plus employer payments of payroll taxes and insurance, health and welfare, pension, vacation, apprenticeship funds, and other direct costs resulting from Federal, State, or local laws, as well as assessments or benefits required by lawful collective bargaining agreements.
  2. Labor Unit Productivity for a given task or trade shall not be calculated at a lesser productivity than that published by industry references as follows:
    - a. Mechanical Trades: SMACNA productivity rates increased by 30 percent (30 percent greater productivity for a given task than specified by the reference).
    - b. Electrical and Division 26 Trades: NECA productivity rates increased by 30 percent (30 percent greater productivity for a given task than specified by the reference).
    - c. All Other Trades: Lee Saylor Estimating Guide productivity using the "Open Shop Rate" for both labor and materials.
  3. Only costs for direct labor related to the Changed or Added Work shall be included. Supervision, Project Manager, Project Engineer, Assistant Superintendent, research and preparation of Change Order Requests and other similar classifications shall be included in the calculation for overhead and not listed separately as line items.
  4. The use of a labor classification, which would increase the extra work cost, will not be permitted unless the Contractor establishes the necessity for such additional costs.
  5. Labor costs for equipment operators and helpers shall be reported only when such costs are not included in the invoice for equipment rental.
  6. Materials shall be at invoice or lowest current price at which such materials are locally available and delivered to the Site in the quantities involved, plus sales tax, freight, and delivery.

7. The Owner reserves the right to approve materials and sources of supply or to supply materials to the Contractor if necessary for the progress of the Work. No markup shall be applied to any material provided by the Owner.
8. Tool and Equipment Rental. No payment will be made for the use of tools which have a replacement value of \$100 or less.
9. Regardless of ownership, the rates to be used in determining equipment rental costs shall not exceed listed rates prevailing locally at equipment rental agencies or distributors at the time the work is performed.
10. The rental rates paid shall include the cost of fuel, oil, lubrication, supplies, small tools, necessary attachments, repairs and maintenance of any kind, depreciation, storage, insurance, and all incidentals.
11. Necessary loading and transportation costs for equipment used on the extra work shall be included. If equipment is used intermittently and, when not in use, could be returned to its rental source at less expense to the Owner than holding it at the work Site, it shall be returned unless the Contractor elects to keep it at the work Site at no expense to the Owner.
12. Other Items. The Owner may authorize other items which may be required on the extra work. Such items include labor, services, material, and equipment which are different in their nature from those required by the Work, and which are of a type not ordinarily available from the Contractor or any of the Subcontractors. Invoices covering all such items in detail shall be submitted with the request for payment.
13. Invoices. Vendors' invoices for material, equipment rental and other expenditures shall be submitted with the COR. If the request for payment is not substantiated by invoices or other documentation, the Owner may establish the cost of the item involved at the lowest price which was current at the time of the Daily Report.
14. Overhead. Overhead, including direct and indirect costs shall be included in the line item amount shown in the Article FORMAT FOR PROPOSED COST CHANGE, shall be submitted with the COR and shall include all of the following:
  - a. Home office overhead,
  - b. Off-Site supervision,
  - c. Change Order and Change Order Request preparation/negotiation/research,
  - d. Schedule delays,
  - e. Project interference and disruption,
  - f. Additional guaranty and warranty durations,
  - g. On-Site supervision, additional temporary protection,
  - h. Additional temporary utilities,
  - i. Additional material handling costs,
  - j. Additional safety equipment costs.

H. Contractor's Certification:

1. All proposed change order requests, including those originated by the Contractor or those filed as claims, must include the following certification by the Contractor:

"The undersigned Contractor approves the foregoing as to the changes in work, if any, and as to the contract price specified for each item and as to the extension of time allowed, if any, for completion of the project as stated herein, and agrees to furnish all labor, materials, and service and to perform all work necessary to complete any additional work specified for the consideration stated herein. Submission of claims which have no basis in fact or which Contractor knows are false are made at the sole risk of the Contractor and may be a violation of the False Claims Act, as set forth in Government Code Sections 12650 et seq. It is understood that the changes to the Contract Documents set forth herein shall only be effective upon approval by the governing board of the District.

"It is expressly understood that the value of the extra work or changes expressly includes any and all of the Contractor's costs and expenses, both direct and indirect, resulting from additional time required on the project or resulting from delay to the project. Any costs, expenses, damages, or time extensions not included herein are deemed waived."

2. All proposed change orders requests shall be submitted on forms included in this project manual. Change Order Requests submitted on the Contractor's forms, altered, modified, or incomplete forms will be deemed waived.

- I. Format for Change Order Request: The following format shall be prepared by the Contractor to communicate proposed additions and deductions to the Contract.

CHANGE ORDER REQUEST NO. \_\_\_\_\_

	ADDED	CREDIT
<b>GENERAL CONTRACTOR'S WORK</b>		
1. Material (attach itemized quantity and unit cost excluding sales tax)	_____	_____
2. Labor (attach itemized hours and rates)	_____	_____
3. Equipment (attach invoices)	_____	_____
4. Subtotal	_____	_____
5. General Contractor's Overhead and Profit, not to exceed fifteen percent (15%) of line 4.	_____	_____
6. Subtotal	_____	_____
7. Liability and Property Damage Insurance, Worker's Compensation Insurance, Social Security, and Unemployment Taxes, not to exceed thirty-three percent (33%) of line 2.	_____	_____
8. Subtotal General Contractor Work (sum of lines 6 and 7.)	_____	_____
<b>SUBCONTRACT WORK (Provide separate breakdown for each subcontract)</b>		
9. Material (attach itemized quantity and unit cost excluding sales tax)	_____	_____
10. Labor (attach itemized hours and rates)	_____	_____
11. Equipment (attach invoices)	_____	_____
12. Subtotal	_____	_____
13. Subcontractor's overhead and profit on work performed by Sub-contractor, not to exceed fifteen percent (15%) of line 12.	_____	_____
14. Subtotal	_____	_____
15. General Contractor's Overhead and Profit on subcontract work, not to exceed ten percent (10%) of line 14.	_____	_____
16. Liability and Property Damage Insurance, Worker's Compensation Insurance, Social Security, and Unemployment Taxes, not to exceed thirty-three percent (33%) of line 10.	_____	_____
17. Total of Subcontract Work (sum of lines 14, 15 and 16)	_____	_____
18. Subtotal General Contractor and Subcontractor Work (sum of lines 8 and 17.)	_____	_____
19. Applicable Taxes (itemized by levy and by contract)	_____	_____
20. Subtotal (sum of lines 18 and 19)	_____	_____
21. Bond not to exceed one and one half percent (1 1/2%) of line 20.	_____	_____
22. TOTAL (sum of lines 20 and 21.)	_____	_____



- J. The value of such extra work or changes, as determined by any of the aforementioned methods, expressly includes any and all of the Contractor's costs and expenses, both direct and indirect, resulting from additional time required on the project or resulting from delay to the project. Any costs or expenses not included in the COR are deemed waived.
- K. Changes may be made by Owner by an appropriate written Change Order, or, at the Owner's option, such changes shall be implemented immediately upon the Contractor's receipt of an appropriate written directive.
- L. Notice required for Contractor-Initiated Change Order Requests: To request an increase in the Contract Price, or any extension in the Contract Time for completion, Contractor shall give the Owner and the Architect written notice thereof within ten (10) days after the occurrence of the event giving rise to the request, together with detailed estimates of the impact on the Contract Price and/or the Contract Time.
  - 1. This notice shall be given by the Contractor before proceeding to execute the Work.
  - 2. No request shall be considered unless made in accordance with this Article; however, the mere presentation of such claim shall not establish the validity of the cause giving rise to such request, or of the extension of the Contract Time, and/or the increase in the Contract Price.
  - 3. Contractor shall proceed to execute the Work even though the adjustment has been rejected or not agreed upon.
  - 4. Failure to provide the required notice within the stated time constitutes an express waiver of request.
  - 5. Any change in the Contract Price or extension of the Contract Time resulting from such request shall be authorized by a Change Order.

#### **1.09 CHANGE ORDERS ("CO")**

- A. No Changes Without Authorization;
  - 1. There shall be no change whatsoever in the drawings, specifications, or in the Work without an executed Change Order or an order by the Architect for a minor change in the Work as herein provided.
  - 2. Owner shall not be liable for the cost of any extra work or any substitutions, changes, additions, omissions, or deviations from the Drawings and Specifications unless the same shall have been authorized by and the cost thereof approved in writing by Change Order.
  - 3. No extension of time for performance of the Work shall be allowed hereunder unless claim for such extension is made at the time changes in the Work are ordered, and such time duly adjusted in writing in the Change Order.
  - 4. The provisions of the Contract Documents shall apply to all such changes, additions, and omissions with the same effect as if originally embodied in the Drawings and Specifications.
  - 5. Notwithstanding anything to the contrary in this Article, all Change Orders shall be prepared and issued by the Architect and shall become effective when executed by the Owner, the Architect, the Contractor, and associated Construction Change Document (CCD) approved by DSA.
- B. Owner will designate in writing the person who is authorized to execute change orders.
- C. Contractor may initiate changes by submitting a written notice to Architect containing:
  - 1. Description of the proposed changes.

2. Statement of the reason for making the changes.
  3. Statement of the effect on the contract sum and the contract time.
  4. Statement of the effect on the work of separate contractors.
  5. Documentation supporting any change in contract sum or contract time as appropriate.
- D. A Change Order is a written instrument prepared by the Architect and signed by the Owner, the Contractor, and the Architect stating their agreement upon all of the following:
1. a change in the Work;
  2. the amount of the adjustment in the Contract Sum, if any; and
  3. the extent of the adjustment in the Contract Time, if any.
- E. The following paragraph shall be a part of each Change Order:
1. The compensation (time and cost) set forth in this Change Order comprises the total compensation due the Contractor, all Subcontractors and all Suppliers, at all tiers, for the work or change defined in the Change Order, including all impact on unchanged work. By signing this Change Order the Contractor acknowledges and agrees, on behalf of themselves, all Subcontractors and all Suppliers, at all tiers, that the stipulated compensation includes payment for all work contained in the Change Order, plus all payment for the interruption of schedules, extended and unabsorbed overhead costs, delay, disruption, and all impact, ripple impact or cumulative impact on all other work under this Contract. The signing of the Change Order indicates that the Change Order constitutes full mutual accord and satisfaction for the changed work, and that the time and cost under the Change Order constitutes the total equitable adjustment owed the Contractor, all Subcontractors and all Suppliers, at all tiers, as a result of the change. The Contractor, on behalf of themselves, all Subcontractors and all Suppliers, at all tiers, agrees to waive all rights, without exception or reservation of any kind whatsoever to file any further claim related to this Change Order. No further claim or request for equitable adjustment of any kind whatsoever shall arise out of or as a result of this change or the impact of this change on the remainder of the work under this Contract.
- F. For a "close out" Change Order (i.e., the final Change Order on the project), add the following paragraph.
1. By execution of this Change Order the Contractor specifically waives, relinquishes, and releases any and all rights under Section 1542 of the California Civil Code which reads as follows:  
  
"A GENERAL RELEASE DOES NOT EXTEND TO CLAIMS WHICH THE CREDITOR DOES NOT KNOW OR SUSPECT TO EXIST IN HIS OR HER FAVOR AT THE TIME OF EXECUTING THE RELEASE, WHICH IF KNOWN BY HIM OR HER MUST HAVE MATERIALLY AFFECTED HIS OR HER SETTLEMENT WITH THE DEBTOR."

#### **1.10 EXECUTION OF CHANGE ORDERS**

- A. Execution of Change Orders: Architect/Engineer will issue Change Orders for signatures of parties as provided in the Conditions of the Contract.
- B. Transmittal and Distribution:
  1. Architect will prepare and execute the Change Order and forward to Contractor.

2. Contractor shall execute the Change Order and forward to Architect. Architect will forward Change Order to Owner.
3. Owner will execute the Change Order and forward to the Architect.

#### **1.11 CORRELATION OF CONTRACTOR SUBMITTALS**

- A. Promptly revise Schedule of Values and Application for Payment forms to record each authorized Change Order as a separate line item and adjust the Contract Sum/Price.
- B. Promptly revise progress schedules to reflect any change in Contract Time, revise sub-schedules to adjust times for other items of work affected by the change, and resubmit.
- C. Promptly enter changes in Project Record Documents.

#### **PART 2 PRODUCTS**

Not Used.

#### **PART 3 EXECUTION**

##### **3.01 ELECTRONIC PROCESSING PROCEDURES**

- A. Modification requests shall be transmitted to the Architect using the project's cloud-based file sharing and storage service ("project's website") with electronic, editable (PDF) format attachments, as required. The cloud-based file sharing and storage service will be selected by the Architect. Contractor's failure to utilize, provide entries and processing through the Architect's cloud-based system will subject Contractor to hourly back charges associated with efforts required by others to perform work which is the contractual responsibility of the Contractor.
- B. Contractor's cost related to use of the project's website services shall be included in the Contractor's bid.
- C. Provide hardcopy submittals if requested by Architect.
- D. The Architect's review comments and/or direction will be made available on the project's website for downloading.
- E. Contractor will distribute a hardcopy of all reviewed request and direction to the Inspector of Record, Owner, and Construction Manager.

**END OF SECTION**

(MODIFICATION PROCEDURE FORMS FOLLOW)

REQUEST FOR INFORMATION  
ARCHITECT'S SUPPLEMENTAL INSTRUCTIONS

REQUEST FOR PROPOSAL  
POTENTIAL CHANGE ORDER  
CHANGE ORDER



**Request for Information**

Detailed, RFIs without Routing Information Grouped by RFI Number

Project Number: DSA Application: DSA File:			
			<b>Date Created:</b>
<b>Answer Company</b>	<b>Answered By</b>	<b>Author Company</b>	<b>Authored By</b>
Quattrocchi Kwok Architects 636 5th Street Santa Rosa, CA 95404			
<b>Co-Respondent</b>		<b>Author RFI Number</b>	
<b>Subject</b>	<b>Discipline</b>	<b>Category</b>	
<b>Cost Impact</b>	<b>Amount</b>	<b>Schedule Impact</b>	<b>Days</b>
		0	
<b>Cost Impact Comments</b>		<b>Schedule Impact Comments</b>	
<b>Drawing/Specification Section Reference:</b>			
<b>Question</b>			<b>Date Required:</b>
<b>Suggestion</b>			
<b>Answer</b>			<b>Date Answered:</b>



## Architect's Supplemental Instruction

Detailed, Grouped by Each Number

---

Project Number:  
DSA Application:  
DSA File:

**Number:**

**Date:**

**To:**

**From:** Quattrocchi Kwok Architects

636 5th Street  
Santa Rosa, CA 95404

**Subject**

**Reference Drawing/Detail**

**Attachments**

**Description**



-O-1.6

## Request for Proposal

---

Project Number:  
DSA Application:  
DSA File:

---

### **RFP** \_\_\_

Please submit an itemized proposal for changes in the Contract Sum or Contract Time for proposed modifications to the Contract Documents described herein. Submit proposal within ten (10) days or notify the Architect in writing of the date on which you anticipate submitting your proposal. Proposal shall include all impacts related to this change and contractor is due no further completion than represented by proposal for change or any impacts related to change.

THIS IS NOT A CHANGE ORDER OR A DIRECTION TO PROCEED WITH THE WORK DESCRIBED IN THE PROPOSED MODIFICATIONS.

Please provide itemized pricing for the following description of work:

### **Attachments:**



Potential Change Orders

Detailed, Grouped by Each Number

---

Project Number:  
DSA Application:  
DSA File:

---

PCO Number:	Title:	Status:
Date Created	Reference	
Full Description		
Schedule Adjustment		
Requested Days	Approved Days	
Price Adjustment		
Proposed Amount	Approved Amount	Applied Amount



PROJECT:

Project No.: \_\_\_\_\_  
Date: \_\_\_\_\_  
DSA App. No.: \_\_\_\_\_  
Page \_\_\_\_\_  
of \_\_\_\_\_

Line TITLE: ADDED CREDIT

---

ALL LINES SHALL BE FILLED IN, (zero values acceptable).

**GENERAL CONTRACTOR'S WORK**

1	Material (attach itemized quantity and unit cost <u>excluding</u> sales tax)	_____	_____
2	Labor (attach itemized hours and rates)	_____	_____
3	Equipment (attach invoices)	_____	_____
4	<b>Subtotal</b>	_____	_____
5	General Contractor's Overhead and Profit, not to exceed fifteen percent (15%) of line 4.	_____	_____
6	<b>Subtotal</b>	_____	_____
7	Liability and Property Damage Insurance, Worker's Compensation Insurance, Social Security, and Unemployment Taxes, not to exceed thirty-three percent (33%) of line 2.	_____	_____
8	<b>Subtotal</b> General Contractor Work (sum of lines 6 and 7.)	_____	_____

**SUBCONTRACT WORK** (Provide separate breakdown for each subcontract)\*

9	Material (attach itemized quantity and unit cost <u>excluding</u> sales tax)	_____	_____
10	Labor (attach itemized hours and rates)	_____	_____
11	Equipment (attach invoices)	_____	_____
12	<b>Subtotal</b>	_____	_____
13	Subcontractor's overhead and profit on work performed by Sub-contractor, not to exceed fifteen percent (15%) of line 12.	_____	_____
14	<b>Subtotal</b>	_____	_____
15	General Contractor's Overhead and Profit on subcontract work, not to exceed ten percent (10%) of line 14.	_____	_____
16	Liability and Property Damage Insurance, Worker's Compensation Insurance, Social Security, and Unemployment Taxes, not to exceed thirty-three percent (33%) of line 10.	_____	_____
17	<b>Total</b> of Subcontract Work (sum of lines 14, 15 and 16)	_____	_____
18	<b>Subtotal</b> General Contractor and Subcontractor Work (sum of lines 8 and 17.)	_____	_____
19	Applicable Taxes (itemized by levy and by contract)	_____	_____
20	<b>Subtotal</b> (sum of lines 18 and 19)	_____	_____
21	Bond not to exceed one and one half (1 1/2%) of line 20.	_____	_____
22	<b>TOTAL</b> (sum of lines 20 and 21.) Copy to cover page.	_____	_____

\* Attach additional copies of this page as required to summarize additional subcontracts.

# CHANGE ORDER

	Distribution to
<input checked="" type="checkbox"/>	OWNER
<input checked="" type="checkbox"/>	ARCHITECT
<input checked="" type="checkbox"/>	CONTRACTOR
<input checked="" type="checkbox"/>	IOR (copy)
<input checked="" type="checkbox"/>	ORS
<input type="checkbox"/>	

298 - O - 1.8  
**CO**  
**00**

P:\298.97 - Rincon Valley ES (Skyhawk)\FILES\I-OR-1.5\298-CO.XLS

PROJECT

Change Order No.

Zero (00)

Project No.  
Initiation Date:  
Contract For:  
Contract Date  
ORS File No.  
ORS App. No.  
OPSC App. No.

CONTRACTOR

You are directed to make the following changes in this contract: (Refer to Attached Summary)

*Reserved for Architect's Stamp*

*Reserved for DSA/ORS Approval Stamp*

The original Contract Sum was \_\_\_\_\_

Net change by previous Change Orders \_\_\_\_\_

The Contract Sum prior to this Change Order was \_\_\_\_\_

The Contract Sum will be UNCHANGED by this Change Order in the amount of \_\_\_\_\_

The new Contract Sum including this Change Order will be \_\_\_\_\_

The Contract Time will be UNCHANGED by this Change Order in the amount of \_\_\_\_\_

The Date of Completion as of the date of this Change Order: \_\_\_\_\_

**Not valid until signed by both the Owner and the Architect.**

Signature of the contractor indicates his approval herewith, including any adjustment in the Contract Sum or Contract Time.

The compensation (time and cost) set forth in this Change Order comprises the total compensation due the Contractor, all Subcontractors and all Suppliers, at all tiers, for the work or change defined in the Change Order, including all impact on unchanged work. By signing this Change Order the Contractor acknowledges and agrees, on behalf of themselves, all Subcontractors and all Suppliers, at all tiers, that the stipulated compensation includes payment for all work contained in the Change Order, plus all payment for the interruption of schedules, extended and unabsorbed overhead costs, delay, disruption, and all impact, ripple impact or cumulative impact on all other work under this Contract. The signing of the Change Order indicates that the Change Order constitutes full mutual accord and satisfaction for the changed work, and that the time and cost under the Change Order constitutes the total equitable adjustment owed the Contractor, all Subcontractors and all Suppliers, at all tiers, as a result of the change. The Contractor, on behalf of themselves, all Subcontractors and all Suppliers, at all tiers, agrees to waive all rights, without exception or reservation of any kind whatsoever to file any further claim related to this Change Order. No further claim or request for equitable adjustment of any kind whatsoever shall arise out of or as a result of this change or the impact of this change on the remainder of the work under this Contract.

**By execution of this Change Order the Contractor specifically waives, relinquishes, and releases any and all rights under Section 1542 of the California Civil Code which reads as follows:**

"A GENERAL RELEASE DOES NOT EXTEND TO CLAIMS WHICH THE CREDITOR DOES NOT KNOW OR SUSPECT TO EXIST IN HIS FAVOR AT THE TIME OF EXECUTING THE RELEASE, WHICH IF KNOWN BY HIM MUST HAVE MATERIALLY EFFECTED HIS SETTLEMENT WITH THE DEBTOR."

ARCHITECT

CONTRACTOR

OWNER

**QUATTROCCHI KWOK ARCHITECTS**  
636 Fifth St.  
Santa Rosa, CA 95404

By.

By.

By.

Date

Date

Date

SUMMARY OF ATTACHMENTS TO:

PROJECT

0  
0

Change Order No. Zero (00)

Project No. \_\_\_\_\_

Contract For: \_\_\_\_\_

ORS App. No. \_\_\_\_\_

The Time for Milestone 1 will be UNCHANGED by this Change Order in the amount of \_\_\_\_\_

The Date of Milestone 1 as of the date of this Change Order therefore is \_\_\_\_\_

The Time for Milestone 2 will be UNCHANGED by this Change Order in the amount of \_\_\_\_\_

The Date of Milestone 2 as of the date of this Change Order therefore is \_\_\_\_\_

No.	Reference:	Description:	C.O.R. #	Request by:	Amount	Calendar Days Added to Contract			
						DoC	M1	M2	M3
<b>TOTALS:</b>					\$ -	0	0	0	0
1.									
2.									
3.									
4.									
5.									
6.									
7.									
8.									
9.									
10.									
11.									
12.									
13.									
14.									
15.									
16.									
17.									
18.									
19.									
20.									
21.									
22.									
23.									
24.									
25.									
26.									
27.									
28.									
29.									
30.									
31.									
32.									
33.									
34.									
35.									
END OF SUMMARY									

## SECTION 01 2900

### APPLICATIONS FOR PAYMENT

#### PART 1 GENERAL

##### 1.01 DESCRIPTION

- A. Payment Procedures:
  - 1. Schedule of Values.
  - 2. Applications for Payment.
  - 3. Conditions of Payment.
  - 4. Final Payment.
  - 5. Contractor Submittals.
  
- B. Related Documents
  - 1. Document - Contract (Agreement Between Owner and Contractor): Lump Sum.
  - 2. Document - General Conditions: Progress Payments, Retainages and Final Payment, Applicability of Labor Compliance Program.
  - 3. District Labor Compliance Program, as applicable to the project.
  - 4. Section 01 2600 - Modification Procedures: Change Orders.
  - 5. Section 01 3900 - Coordination and Meetings.
  - 6. Section 01 3300 - Submittals: Submittal procedures.
  - 7. Section 01 3200 - Construction Progress Schedules.
  - 8. Section 01 7000 - Contract Closeout: Final payment.

##### 1.02 SUBMITTALS

- A. On forms approved by the Owner, the Contractor shall furnish the following:
  - 1. Within ten (10) days of the award of the Contract, a detailed breakdown of the Contract Price (Schedule of Values) for each Project or Site;
  - 2. Within ten (10) days of the award of the Contract, a schedule of estimated monthly payment requests (cash flow) due the Contractor showing the values and construction time of the various portions of the Work to be performed by it and by its Subcontractors or material and equipment suppliers containing such supporting evidence as to its correctness as the Owner may require;
  - 3. Within ten (10) days, the name, address, telephone number, fax number, license number, and classification of all of its Subcontractors and of all other parties furnishing labor, material, or equipment for its Contract, along with the amount of each such subcontract or the price of such labor, material, and equipment needed for its entire portion of the Work.
  - 4. Five (5) days prior to the submission of a pay request, an itemized breakdown of work done for the purpose of requesting partial payments;
  - 5. Five (5) days prior to the submission of a pay request, the minutes of Coordination Meetings per Section 01 3900.
  - 6. Five (5) days prior to the submission of a pay request, updated Construction Progress Schedule per Section 01 32g00.

7. For all public works projects subject to prevailing wage requirements of the Labor Code: submittal of electronic certified payroll records to the State Labor Commissioner maintained on a weekly basis, as required (Labor Code Section 1776), and penalties for failure to do so (Labor Code Section 1776(g)); The requirement includes and applies to all subcontractors performing work on projects even if their portion of the work is less than one half of one percent of the total amount of the contract.
- B. Owner Approval Required
1. The Owner shall review all submissions received pursuant to paragraph 1.03 A. in a timely manner. All submissions must be approved by the Owner before becoming the basis of any payment.
- C. Submit itemized applications typed on Application and Certificate for Payment and Continuation Sheet.
- D. Provide itemized data on continuation sheet:
1. Format, schedules, line items and values: Those of the Schedule of Values accepted by Architect.
- E. Obtain signature of Owner's Inspector on Application for Payment Continuation Sheet with each application prior to submittal to Architect.

### **1.03 SCHEDULE OF VALUES**

- A. The Schedule of Values shall be used only as the basis for the Contractor's Progress Payments.
- B. Upon request of the Architect, support the values with data which will substantiate their correctness.
- C. Correlate line items in the Schedule of Values with other required administrative schedules and forms, including:
1. Contractor's construction schedule.
  2. Application for Payment form.
  3. List of subcontractors
  4. List of products.
  5. List of principal suppliers and fabricators.
  6. Schedule of submittals.
- D. Form of Schedule: Submit schedule on Application for Payment Continuation Sheet. Identify schedule with;
1. Title of Project and location, and name of Owner.
  2. Architect and Architect's Project Number.
  3. Name and address of Contractor.
  4. Contract designation.
  5. Date of submission.
- E. Schedule shall list the installed value of the component parts of the Work in sufficient detail to serve as a basis for computing values for progress payments during construction. Modify detail as requested by Architect.
- F. Follow the table of contents of this Project Manual as the form for listing component items.

1. Identify each line item with the number and title of the respective section of the specifications.
  2. Include separate line items for each section of Division 01.
- G. For each major line item which has installed value of more than \$10,000.00, list sub-values of major products or operations under the item.
- H. For the various portions of the Work:
1. Itemize separate line item cost for each of following general cost items (if provided):
    - a. Performance and payment bonds.
    - b. Field supervision and layout.
    - c. Temporary facilities and controls.
    - d. Mobilization.
  2. Each item shall include a directly proportional amount of the Contractor's overhead and profit.
  3. For items on which progress payments will be requested for stored materials, break down the value into:
    - a. The cost of the materials, delivered and unloaded, with taxes paid.
    - b. The total installed value.
- I. The sum of all values listed in the schedule shall equal the total Contract Sum.

#### **1.04 APPLICATIONS FOR PAYMENT**

- A. Procedure: On or before the twenty-fifth (25th) day of each calendar month during the progress of the portion of the Work for which payment is being requested, the Contractor shall submit to the Architect an itemized Application for Payment for operations completed in accordance with the Schedule of Values. Such application shall be notarized if the project is subject to a Labor Compliance Program, or if directed by the Owner for projects not subject to as Labor Compliance Program, and supported by all of the following, or such portion thereof as Architect requires:
1. The amount paid to the date of the Application to the Contractor, to all its Subcontractors, and all others furnishing labor, material, or equipment for its Contract;
  2. The amount being requested with the Application for Payment by the Contractor on its own behalf and separately stating the amount requested on behalf of each of the Subcontractors and all others furnishing labor, material, and equipment under the Contract;
  3. The balance that will be due to each of such entities after said payment is made;
  4. A certification that the Record Drawings and Annotated Specifications are current;
  5. The additions to and subtractions from the Contract Price and Time;
  6. A summary of the retentions (each Application shall provide for retention, as set forth above, of the amount due until completion of the Work of the Contractor and Final Acceptance thereof by Owner);
  7. Material invoices, evidence of equipment purchases, rentals, and other support and details of cost as the Owner may require from time to time;
  8. The percentage of completion of the Contractor's Work by line item; and
  9. A statement showing all payments made by the Contractor for labor and materials on account of the Work covered in the preceding Application for Payment.
- B. Application Form:

1. Fill in required information, including that for Change Orders executed prior to date of submittal of application.
  2. Fill in summary of dollar values to agree with respective totals indicated on continuation sheets.
  3. Execute certification with signature of a responsible officer of Contract firm.
- C. Continuation Sheets:
1. Fill in total list of all scheduled component items of Work, with item number and scheduled dollar value for each item.
  2. Fill in dollar value in each column for each scheduled line item when work has been performed or products stored.
  3. List each Change Order executed prior to date of submission, at the end of the continuation sheets.
    - a. List by Change Order Number, and description, as for an original component item of work.
- D. Purchase of Materials and Equipment: The Contractor is required to order, obtain, and store materials and equipment sufficiently in advance of its Work at no additional cost or advance payment from Owner. Therefore, payment by the Owner for stored material shall be made only in unusual circumstances where the Architect specifically recommends, and Owner specifically approves, the payment in writing.  
Payments made on account of materials and equipment not incorporated in the Work shall be conditioned upon submission by the Contractor, Subcontractor, or vendor of:
- a. bills of sale and such other documents satisfactory to the Architect and the Owner to establish the Owner's title to such materials or equipment free of all liens and encumbrances, and otherwise protect the Owner's interest, and:
  - b. including, without limitation, provision of applicable insurance and transportation to the Site.
2. All stored items shall be inventoried, specified by identification numbers (if applicable), released to the Owner by sureties of the Contractor and the Subcontractor and delivered and suitably stored at the Site or at some other location agreed upon in writing by the Owner, if stored off-Site, stored only in a bonded warehouse.
- E. Warranty of Title: The Contractor warrants that title to all Work covered by an Application for Payment will pass to the Owner no later than the time of payment. The Contractor further warrants that upon submittal of an Application for Payment all Work for which Certificates for Payment have been previously issued and payments received from the Owner shall, to the best of the Contractor's knowledge, information, and belief, be free and clear of liens, claims, security interests, or encumbrances in favor of the Contractor, Subcontractors, material and equipment suppliers, or other persons or entities making a claim by reason of having provided labor, materials, and equipment relating to the Work.
- F. Progress Payments:
1. Payments to Contractor

- a. Within thirty (30) days after approval of the Request for Payment, Contractor shall be paid a sum equal to ninety five (95) percent of the value of the Work performed up to the last day of the previous month unless a different retention percentage is stated in the Notice Inviting Bids, in which case that percentage applies, less the aggregate of previous payments. The value of the Work completed shall be an estimate only, no inaccuracy or error in said estimate shall operate to release the Contractor, or any bondsman, from damages arising from such Work or from enforcing each and every provision of this Contract, and the Owner shall have the right subsequently to correct any error made in any estimate for payment.
  - b. The Contractor shall not be entitled to have any payment requests processed, or be entitled to have any payment made for work performed, so long as any lawful or proper direction given by the Owner concerning the Work, or any portion thereof, remains uncomplished with. At any time after fifty percent (50%) of the Work has been completed, if the Owner, by action of its governing body, finds that satisfactory progress is being made, the Owner may make any of the remaining payments in full for actual work completed or may withhold any amount up to ten percent (10%) thereof as the Owner may find appropriate based on the Contractor's progress.
2. Payments to Subcontractors: No later than ten (10) days after receipt, the Contractor shall pay to each Subcontractor, out of the amount paid to the Contractor on account of such Subcontractor's portion of the Work, the amount to which said Subcontractor is entitled, reflecting percentages actually retained from payments to the Contractor on account of such Subcontractor's portion of the Work. The Contractor shall, by appropriate agreement with each Subcontractor, require each Subcontractor to make payments to Sub-subcontractors in a similar manner.
  3. Percentage of Completion or Payment Information: The Owner will, on request, furnish to a Subcontractor, if practicable, information regarding percentages of completion or amounts applied for by the Contractor, and action taken thereon by the Owner, on account of portions of the Work done by such Subcontractor.
  4. No Obligation of Owner for Subcontractor Payment: The Owner shall have no obligation to pay, or to see to the payment of, money to a Subcontractor except as may otherwise be required by law.
  5. Payment to Suppliers: Payment to material or equipment suppliers shall be treated in a manner similar to that provided in paragraphs 1.05 F. 2., 3. and 4.
  6. Payment Not Constituting Approval or Acceptance: An approved Request for Payment, a progress payment, or partial or entire use or occupancy of the Project by the Owner shall not constitute acceptance of work not in accordance with the Contract Documents.
  7. Joint Checks: Owner shall have the right, if necessary for the protection of the Owner, to issue joint checks made payable to the Contractor and Subcontractors and/or material or equipment suppliers. The joint check payees shall be responsible for the allocation and disbursement of funds included as part of any such joint payment. In no event shall any joint check payment be construed to create any contract between the Owner and a Subcontractor of any tier, any obligation from the Owner to such Subcontractor, or rights in such Subcontractor against the Owner.
- G. Labor Compliance: A determination regarding whether this project is subject to prevailing wage requirements of the Labor Code is included in the Instructions to Bidders. Further information is contained in the General Conditions. The Contractor is responsible for enforcement of the terms and conditions of the Labor Code, including electronic certified payroll reporting and posting job site notices prescribed by regulation.



### **1.05 SUBSTANTIATING DATA FOR PROGRESS PAYMENTS**

- A. Each and every Application for Payment shall be accompanied with the complete substantiating data specified in this Section in the article titled CONDITIONS OF PAYMENT.
- B. When the Owner or the Architect requires substantiating data, Contractor shall submit suitable information, with a cover letter identifying:
  - 1. Project.
  - 2. Application number and date.
  - 3. Detailed list of enclosures.
  - 4. For stored products:
    - a. Item number and identification as shown on application.
    - b. Description of specific material.

### **1.06 COMPLETION AND FINAL PAYMENT**

- A. Final Inspection
  - 1. Contractor shall immediately upon receipt of the Punch List, initiate work on all items therein related to Contractor's Work and diligently complete the same. Upon receipt of Contractor's written notice that all of the Punch List items have been fully completed and the Work is ready for final inspection and acceptance, Architect shall inspect the Work and shall submit to Contractor and Owner a final inspection report noting the work, if any, required in order to complete the Work in accordance with the Contract Documents. Absent unusual circumstances, this report shall consist of the Punch List items not yet satisfactorily completed.
  - 2. Upon completion of the Work contained in the final inspection report, the Contractor shall so notify the Owner, who shall again inspect such Work. If the Owner finds the Work contained in such final inspection report acceptable under the Contract Documents and, therefore, the Work fully completed, it shall so notify Contractor, who shall then submit to the Architect its final Application for Payment.
  - 3. Upon receipt and approval of such final Application for Payment, the Architect shall issue a final Certificate of Payment stating that to the best of its knowledge, information, and belief, and on the basis of its observations, inspections, and all other data accumulated or received by the Architect in connection with the Work, such Work has been completed in accordance with the Contract Documents. The Owner shall thereupon inspect such Work and either accept the Work as complete or notify the Architect and the Contractor in writing of reasons why the Work is not complete. Upon acceptance of the Work of the Contractor as fully complete (which, absent unusual circumstances, will occur when the Punch List items have been satisfactorily completed), the Owner shall record a Notice of Completion with the County Recorder, and the Contractor shall, upon receipt of payment from Owner, pay the amounts due Subcontractors.
- B. Retainage: The retainage, less any amounts disputed by the Owner or which the Owner has the right to withhold, shall be paid after approval of the Owner of the Architect's Certificate of Payment referred to in paragraph 1.07 A., after the satisfaction of the conditions set forth in paragraph 1.07 C., and after thirty-five (35) days after the acceptance of the Work and recording of the Notice of Completion by Owner. No interest shall be paid on any retainage, or on any amounts withheld due to a failure of the Contractor to perform, in accordance with the terms and conditions of the Contract Documents.

- C. Procedures for Application for Final Payment: The Application for Final Payment shall be accompanied by the same details as set forth in paragraph 1.05, and in addition, the following conditions must be fulfilled:
1. A full and final waiver of all liens in connection with the Work shall be submitted by Contractor, including a release of lien in recordable form, together with (to the extent permitted by law) a copy of the full and final waiver of all liens, including a release of lien in recordable form, in connection with the Work obtained by Contractor from each person to receive a payment thereunder, which waivers of lien shall be in a form as approved by Owner.
  2. The Contractor shall have made, or caused to have been made, all corrections to the Work which are required to remedy any defects therein, to obtain compliance with the Contract Documents or any requirements of applicable codes and ordinances, or to fulfill any of the orders or directions of Owner required under the Contract.
  3. Each Subcontractor shall have delivered to the Contractor all written guarantees, warranties, applications, and bonds required by the Contract Documents for its portion of the Work.
  4. The Contractor shall deliver to the Owner reproducible final Record Drawings and Annotated Specifications showing the Contractor's Work "as built," with the Contractor's certification of the accuracy of the Record Drawings and Annotated Specifications, all guarantees, and operation and maintenance instructions for equipment and apparatus.
  5. Architect shall have issued a Final Certificate of Payment.
  6. The Contractor shall have delivered to the Owner all manuals and materials required by the Contract Documents.
  7. The Contractor shall have removed, or caused to be removed, all waste materials and rubbish from and about the Site, as well as all tools, construction equipment, machinery, surplus material, scaffolding equipment, and any other similar materials of the Contractor or any subcontractor, shall have cleaned, or caused to be cleaned, all glass surfaces, and shall have left the Work broom-clean, except as otherwise provided in the Contract Documents.
- D. Fill in Application form as specified for progress payments and present the final statement of accounting.
- E. Use continuation sheet for presenting the final statement of accounting as specified in Section 01 7000 - Contract Closeout.
- F. Fill out and submit with application for final payment:
1. Contractor's Affidavit of Payment of Debts and Claims.
  2. Contractor's Affidavit of Release of Liens.
  3. Consent of Surety Company to Final Payment.
  4. Release Form 3 Conditional Waiver and Release Upon Final Payment.
- G. Fill out and submit to Owner prior to receipt of final payment: Release Form 4 Unconditional Waiver and Release Upon Final Payment

#### **1.07 SUBMITTAL PROCEDURE**

- A. Submit Applications for Payment to Architect at the times stipulated in the Agreement.

- B. Number: Five copies of each Application, or four copies in addition to number required by Contractor.
- C. Each Application shall include all of the items listed in the Article titled CONDITIONS OF PAYMENT.

#### 1.08 CONDITIONS OF PAYMENT

- A. Contractor submittal of the following items attached to the Application for Payment Transmittal following this Section with original signature of the Contractor's Project Superintendent, with each and every Application for Payment is a condition precedent to receipt of payment.
  - 1. Certification of Review of Payment Application by original signature on the Application for Payment Transmittal of Contractor's Superintendent. This document shall be counter-signed signifying review and approval by Owner's Inspector of Record.
  - 2. Application for Payment with schedule of values for the period during which Work was performed.
  - 3. Completed Daily Reports for the applicable billing period. Contractors shall maintain daily records of their activities, subcontractors present, number of workers representing each subcontractor, number of workers employed by the Contractor, and any other information deemed pertinent by the Contractor. Architect is not required to review or comment on this information.
  - 4. Completed Schedule Update for the applicable billing period, with all attachments as may be required by Section 01 3200 for that submittal.
  - 5. Provide Certification by original notarized signature of Contractor's Project Superintendent on the Application for Payment Transmittal that the project is on schedule and that the Contractor has experienced no delays or schedule disruptions.
    - a. In the event that a Contractor has experienced delay or disruption in the period for which payment is applied, Contractor must so indicate in writing with original signature on Contractor's company letterhead attached to this certification stating the nature of the delay or disruption, the event that precipitated said delay, and the method of recovering the lost time and maintaining the schedule recommended by the Contractor. Failure to so timely indicate delay or disruption shall be construed as a waiver of claim for damages for same.
  - 6. Certification by original notarized signature of Contractor's Project Superintendent on the Application for Payment Transmittal that Contractor has updated all As-Built Drawings in the Project Superintendent's office.
  - 7. Completed Conditional Waiver and Release Upon Progress Payment Forms for the Contractor and any and all Subcontractors, second and third tier subcontractors and material suppliers or service providers.
  - 8. Completed Unconditional Waiver and Release Upon Progress Payment Forms for previous billing period, if any. Contractor to provide one Unconditional Waiver and Release Upon Progress Payment for every corresponding Conditional Waiver and Release submitted with previous Application for Payment.
  - 9. Copy of Verified Report Form SSS 6, as required during the applicable billing period.
- B. When Architect finds Application and all required submittal attachments properly completed and correct, he or she will transmit Certificate for Payment to Owner, with copy to Contractor. Incomplete or improper submittals will be returned to the Contractor without action.

#### 1.09 REVIEW OF PROGRESS PAYMENT

- A. Owner Approval: The Architect will, within seven (7) days after receipt of the Contractor's Application for Payment, either certify such payment or notify the Contractor in writing of the Architect's reasons for withholding certification in whole or in part as provided above.
- B. Architect's Review: The review of the Contractor's Application for Payment by the Architect is based on the Architect's observations at the Site and the data comprising the Application for Payment that the Work has progressed to the point indicated and that, to the best of the Architect's knowledge, information, and belief, the quality of the Work is in accordance with the Contract Documents. The foregoing representations are subject to an evaluation of the Work for conformance with the Contract Documents, to results of subsequent tests and inspections, to minor deviations from the Contract Documents correctable prior to completion, and to specific qualifications expressed by the Architect. The issuance of a Certificate for Payment will further constitute a representation that the Contractor is entitled to payment in the amount certified. However, the review by the Architect will not be a representation that the Architect has:
1. Made exhaustive or continuous on-Site inspections to check the quality or quantity of the Work;
  2. Reviewed construction means, methods, techniques, sequences, or procedures;
  3. Reviewed copies of requisitions received from Subcontractors, material and equipment suppliers, and other data requested by the Owner to substantiate the Contractor's right to payment; or
  4. Made an examination to ascertain how or for what purpose the Contractor has used money previously paid on account of the Contract Sum.
  5. Reviewed or examined for accuracy or completeness any documentation submitted to comply with the Owner's Labor Compliance Program.

#### **1.10 DECISIONS TO WITHHOLD PAYMENT**

- A. Reasons to Withhold Payment: The Owner may decide to withhold payment in whole, or in part, to the extent reasonably necessary to protect the Owner if, in the Owner's opinion, the representations to the Owner required by the Article titled REVIEW OF PROGRESS PAYMENT cannot be made. The Owner may withhold payment, in whole, or in part, to such extent as may be necessary to protect the Owner from loss because of:
1. Defective Work not remedied;
  2. Stop Notices filed, unless the Contractor at its sole expense provides a bond or other security satisfactory to the Owner in the amount of at least one hundred twenty-five percent (125%) of the claim, in a form satisfactory to the Owner, which protects the Owner against such claims;
  3. Liquidated damages assessed against the Contractor;
  4. Reasonable doubt that the Work can be completed for the unpaid balance of any Contract Price or by the completion date;
  5. Damage to the Owner, another contractor, or subcontractor;
  6. Unsatisfactory prosecution of the Work by the Contractor;
  7. Failure to store and properly secure materials;

8. Failure of the Contractor to submit on a timely basis, proper and sufficient documentation required by the Contract Documents, including, without limitation, monthly progress schedules, shop drawings, submittal schedules, schedule of values, product data and samples, proposed product lists, executed change orders, and verified reports, certifications, certified payrolls, any submittals required by the Labor Compliance Program but not enumerated in this or other sections of these specifications, as applicable, and other submittals specified as conditions precedent to receipt of payment in the Article titled CONDITIONS OF PAYMENT;
  9. Failure of the Contractor to maintain record drawings;
  10. Erroneous estimates by the Contractor of the value of the Work performed, or other false statements in an Application for Payment;
  11. Unauthorized deviations from the Contract Documents; or
  12. Failure of the Contractor to prosecute the Work in a timely manner in compliance with established progress schedules and completion dates.
  13. Failure of the Contractor to conform to the requirements of the Labor Compliance Plan as applicable.
- B. Written Reasons for Withholding Provided: Upon request of the Contractor whose payment is deferred, the Contractor shall be given a written copy of Owner's reasons for withholding payment.
- C. Payment After Cure: When the grounds for declining approval are removed, payment shall be made for amounts withheld because of them. No interest shall be paid on any retainage or amounts withheld due to the failure of the Contractor to perform in accordance with the terms and conditions of the Contract Documents.
- D. Labor Compliance Penalties: In addition to the remedy of withholding payment, the Owner may assess penalties as described in the Labor Compliance Program or as otherwise required by law for failure of the Contractor to conform to the requirements of the Labor Compliance Plan.

#### **1.11 SUBSTITUTION OF SECURITIES**

- A. In accordance with § 22300 of the Public Contract Code, the Owner will permit the substitution of securities for any monies withheld by the Owner to ensure performance under the Contract. At the request and expense of the Contractor, securities equivalent to the amount withheld shall be deposited with the Owner, or with a state or federally chartered bank as the escrow agent, who shall then pay such monies to the Contractor. Upon satisfactory completion of the Contract, the securities shall be returned to the Contractor.
- B. Securities eligible for investment under this section shall include those listed in Government Code § 16430, bank or savings and loan certificates of deposit, interest-bearing, demand-deposit accounts, standby letters of credit, or any other security mutually agreed to by the Contractor and the Owner.
- C. The Contractor shall be the beneficial owner of any securities substituted for monies withheld and shall receive any interest thereon.
- D. The escrow agreement used for the purposes of this Section shall be substantially similar to the form set forth in Public Contract Code § 22300.

**PART 2 PRODUCTS**

Not Used.

**PART 3 EXECUTION**

Not Used.

**END OF SECTION**

(APPLICATION FOR PAYMENT FORMS FOLLOW)  
APPLICATION FOR PAYMENT TRANSMITTAL  
APPLICATION AND CERTIFICATE FOR PAYMENT  
APPLICATION FOR PAYMENT CONTINUATION SHEET  
CONTRACTOR'S AFFIDAVIT OF PAYMENT OF DEBTS AND CLAIMS  
CONTRACTOR'S AFFIDAVIT OF RELEASE OF LEINS  
CONSENT OF SURETY TO FINAL PAYMENT  
RELEASE FORMS 1 THROUGH 4

WHEN NOTED IN THE GENERAL CONDITIONS AS PART OF THE PROJECT,  
DISTRICT LABOR COMPLIANCE PROGRAM WILL BE  
BOUND FOLLOWING THIS SECTION

RELEASE FORM 1  
CONDITIONAL WAIVER AND RELEASE ON PROGRESS PAYMENT  
(Civil Code Sec. 8132)

NOTICE: THIS DOCUMENT WAIVES THE CLAIMANT’S LIEN, STOP PAYMENT NOTICE, AND  
PAYMENT BOND RIGHTS EFFECTIVE ON RECEIPT OF PAYMENT. A PERSON SHOULD NOT RELY  
ON THIS DOCUMENT UNLESS SATISFIED THAT THE CLAIMANT HAS RECEIVED PAYMENT.

**Identifying Information**

Name of Claimant: .....

Name of Customer: .....

Job Location: .....

Owner: .....

Through Date: .....

**Conditional Waiver and Release**

This document waives and releases lien, stop payment notice, and payment bond rights the claimant has for labor and service provided, and equipment and material delivered, to the customer on this job through the Through Date of this document. Rights based upon labor or service provided, or equipment or material delivered, pursuant to a written change order that has been fully executed by the parties prior to the date that this document is signed by the claimant, are waived and released by this document, unless listed as an Exception below. This document is effective only on the claimant’s receipt of payment from the financial institution on which the following check is drawn:

Maker of Check: .....

Amount of Check: \$ .....

Check Payable to: .....

**Exceptions**

This document does not affect any of the following:

- (1) Retentions.
- (2) Extras for which the claimant has not received payment.
- (3) The following progress payments for which the claimant has previously given a conditional waiver and release but has not received payment:  
Date(s) of waiver and release: .....

Amount(s) of unpaid progress payment(s): \$ .....

- (4) Contract rights, including (A) a right based on rescission, abandonment, or breach of contract, and (B) the right to recover compensation for work not compensated by the payment.

**Signature**

Claimant’s Signature: .....

Claimant’s Title: .....

Date of Signature: .....

RELEASE FORM 2

UNCONDITIONAL WAIVER AND RELEASE ON PROGRESS PAYMENT  
(Civil Code Sec. 8134)

NOTICE TO CLAIMANT: THIS DOCUMENT WAIVES AND RELEASES LIEN, STOP PAYMENT NOTICE, AND PAYMENT BOND RIGHTS UNCONDITIONALLY AND STATES THAT YOU HAVE BEEN PAID FOR GIVING UP THOSE RIGHTS. THIS DOCUMENT IS ENFORCEABLE AGAINST YOU IF YOU SIGN IT, EVEN IF YOU HAVE NOT BEEN PAID. IF YOU HAVE NOT BEEN PAID, USE A CONDITIONAL WAIVER AND RELEASE FORM.

**Identifying Information**

Name of Claimant: .....  
Name of Customer: .....  
Job Location: .....  
Owner: .....  
Through Date: .....

**Unconditional Waiver and Release**

This document waives and releases lien, stop payment notice, and payment bond rights the claimant has for labor and service provided, and equipment and material delivered, to the customer on this job through the Through Date of this document. Rights based upon labor or service provided, or equipment or material delivered, pursuant to a written change order that has been fully executed by the parties prior to the date that this document is signed by the claimant, are waived and released by this document, unless listed as an Exception below. The claimant has received the following progress payment:

\$ .....

**Exceptions**

This document does not affect any of the following:

- (1) Retentions.
- (2) Extras for which the claimant has not received payment.
- (3) Contract rights, including (A) a right based on rescission, abandonment, or breach of contract, and (B) the right to recover compensation for work not compensated by the payment.

**Signature**

Claimant's Signature: .....  
Claimant's Title: .....  
Date of Signature: .....



RELEASE FORM.3

CONDITIONAL WAIVER AND RELEASE ON FINAL PAYMENT  
(Civil Code Sec. 8136)

NOTICE: THIS DOCUMENT WAIVES THE CLAIMANT'S LIEN, STOP PAYMENT NOTICE, AND PAYMENT BOND RIGHTS EFFECTIVE ON RECEIPT OF PAYMENT. A PERSON SHOULD NOT RELY ON THIS DOCUMENT UNLESS SATISFIED THAT THE CLAIMANT HAS RECEIVED PAYMENT.

**Identifying Information**

Name of Claimant: .....

Name of Customer: .....

Job Location: .....

Owner: .....

**Conditional Waiver and Release**

This document waives and releases lien, stop payment notice, and payment bond rights the claimant has for labor and service provided, and equipment and material delivered, to the customer on this job. Rights based upon labor or service provided, or equipment or material delivered, pursuant to a written change order that has been fully executed by the parties prior to the date that this document is signed by the claimant, are waived and released by this document, unless listed as an Exception below. This document is effective only on the claimant's receipt of payment from the financial institution on which the following check is drawn:

Maker of Check: .....

Amount of Check: \$ .....

Check Payable to: .....

**Exceptions**

This document does not affect any of the following:

Disputed claims for extras in the amount of: \$ .....

**Signature**

Claimant's Signature: .....

Claimant's Title: .....

Date of Signature: .....

RELEASE FORM 4

UNCONDITIONAL WAIVER AND RELEASE ON FINAL PAYMENT  
(Civil Code Sec. 8138)

NOTICE TO CLAIMANT: THIS DOCUMENT WAIVES AND RELEASES LIEN, STOP PAYMENT NOTICE, AND PAYMENT BOND RIGHTS UNCONDITIONALLY AND STATES THAT YOU HAVE BEEN PAID FOR GIVING UP THOSE RIGHTS. THIS DOCUMENT IS ENFORCEABLE AGAINST YOU IF YOU SIGN IT, EVEN IF YOU HAVE NOT BEEN PAID. IF YOU HAVE NOT BEEN PAID, USE A CONDITIONAL WAIVER AND RELEASE FORM.

**Identifying Information**

Name of Claimant: .....

Name of Customer: .....

Job Location: .....

Owner: .....

Through Date: .....

**Unconditional Waiver and Release**

This document waives and releases lien, stop payment notice, and payment bond rights the claimant has for all labor and service provided, and equipment and material delivered, to the customer on this job. Rights based upon labor or service provided, or equipment or material delivered, pursuant to a written change order that has been fully executed by the parties prior to the date that this document is signed by the claimant, are waived and released by this document, unless listed as an Exception below. The claimant has been paid in full.

**Exceptions**

This document does not affect the following:

Disputed claims for extras in the amount of: \$ .....

**Signature**

Claimant's Signature: .....

Claimant's Title: .....

Date of Signature: .....

# APPLICATION FOR PAYMENT TRANSMITTAL

Distribution to:

<input checked="" type="checkbox"/>	OWNER
<input checked="" type="checkbox"/>	ARCHITECT
<input type="checkbox"/>	CONTRACTOR
<input checked="" type="checkbox"/>	INSPECTOR
<input type="checkbox"/>	

Distribution By: \_\_\_\_\_ - O - 1.11

**A4P**

<input checked="" type="checkbox"/>	FAX
<input checked="" type="checkbox"/>	MAIL
<input type="checkbox"/>	OVERNIGHT
<input type="checkbox"/>	HAND DELIVERY
<input type="checkbox"/>	

P:\ProjectNo.ProjectName\Files\IO-CA\11-A4PLCPv2.0\4/2003

PROJECT: 0 0 0 0	ARCHITECT: <b>Quattrocchi Kwok Architects</b> 636 Fifth Street Santa Rosa, CA 95404 Fax 707-576-0295	Application No. _____ Date: _____ Arch. Project No.: <u>0</u> Contract For: <u>Increment 1</u> Contract Date: <u>1/0/1900</u> DSA File No.: <u>0.00</u> DSA App. No.: <u>0</u> OPSC App. No.: <u>0</u> Contr. Project No.: _____
OWNER: 0 0 0	Inspector of Record 0 0 0	
Fax: <u>0</u>	Fax <u>0</u> Phone: <u>0</u>	

The following documents are attached to this transmittal, in accordance with Section 01027 - Applications for Payment. This certification must accompany each Application for Payment.

- |   |  |                    |
|---|--|--------------------|
| 1 | Application for Payment and Schedule of Values (AIA Forms G702 and G703)                             | Completed (signed) |
| 2 | Contractor's Certified Payroll Report for billing period electronically submitted to DIR.            | _____              |
| 3 | Contractor's Complete Daily Logs for billing period noted.   | _____              |
| 4 | Completed Schedule update for the billing period noted.  | _____              |
| 5 | Complete Conditional Waiver and and Release upon Progress Payment form.                              | _____              |
| 6 | Complete Unconditional Waiver and Release upon Progress Payment Form for month preceding.            | _____              |
| 7 | Original signature copies of DSA SSS-6 Verified Report Form (required for Release of Final Payment). | _____              |

**INSPECTOR:**

The undersigned has reviewed the attached Application for Payment and finds it representative of the work completed and material stored at the site. I recommend that the Architect certify and the District process payment to the Contractor as noted on the Application for Payment.  
All the above prerequisites for Progress Payment have been met by the Contractor.

0  
0  
0

By. \_\_\_\_\_  
original signature required

Date: \_\_\_\_\_

**CONTRACTOR:**

The undersigned certifies under penalty of perjury that the attached submittals are complete and correct; that the project is on schedule and has experienced no delays or disruption through the date of this transmittal except as shown on the attached Project Schedule of same date; and the Record drawings have been maintained and updated in accordance with the Contract Documents through the period as shown on the attached Application for Payment.

0 By. \_\_\_\_\_  
0 original signature required  
0 Date: \_\_\_\_\_

State of: \_\_\_\_\_  
County of: \_\_\_\_\_  
Subscribed and sworn to  
before me this \_\_\_\_ day of \_\_\_\_  
Notary Public:  
My Commission expires: \_\_\_\_\_ Notary Stamp Above  
Notary stamp required for projects with Labor Compliance Program

NOTE: All required original signatures must be affixed before processing of Application by the Architect.  
Incomplete applications may be returned without action.

# Application and Certificate for Payment

TO OWNER: PROJECT: APPLICATION NO.: DISTRIBUTION TO:  
 PERIOD TO: Owner   
 CONTRACT FOR: Architect   
 CONTRACT DATE: Contractor   
 PROJECT NOS.: Field   
 Other

FOR CONTRACTOR: VIA ARCHITECT:

## CONTRACTOR'S APPLICATION FOR PAYMENT

Application is made for payment, as shown below, in connection with the Contract. Continuation Sheet is attached.

- 1. ORIGINAL CONTRACT SUM \$ \_\_\_\_\_
- 2. NET CHANGE BY CHANGE ORDERS \$ \_\_\_\_\_
- 3. CONTRACT SUM TO DATE (line 1 + 2) \$ \_\_\_\_\_
- 4. TOTAL COMPLETED & STORED TO DATE (column G) \$ \_\_\_\_\_

- 5. RETAINAGE:
  - a. \_\_\_\_% of Completed Work \$ \_\_\_\_\_  
(Columns D & E)
  - b. \_\_\_\_% of Stored Material \$ \_\_\_\_\_  
(Column F)

Total Retainage (Lines 5a + 5b) \$ \_\_\_\_\_

6. TOTAL EARNED LESS RETAINAGE \$ \_\_\_\_\_  
*(Line 4 minus Line 5 Total)*

7. LESS PREVIOUS CERTIFICATES FOR PAYMENTS \$ \_\_\_\_\_  
*(Line 6 from prior Certificate)*

8. CURRENT PAYMENT DUE \$ \_\_\_\_\_

9. BALANCE TO FINISH, INCLUDING RETAINAGE \$ \_\_\_\_\_  
*(Line 3 minus Line 6)*

CHANGE ORDER SUMMARY	ADDITIONS	DEDUCTIONS
Total changes approved in previous months by Owner	\$ _____	\$ _____
Total approved this month	\$ _____	\$ _____
TOTAL	\$ _____	\$ _____
NET CHANGES by Change Order	\$ _____	\$ _____

The undersigned Contractor certifies and declares under penalty of perjury under the laws of the state of California that to the best of the Contractor's knowledge, information and belief the Work covered by this Application for Payment has been completed in accordance with the Contract Documents, that all amounts have been paid by the Contractor for work for which previous Certificates for Payment were issued and payments received from the Owner, and that current payment shown herein is due.

CONTRACTOR: \_\_\_\_\_ Date: \_\_\_\_\_  
 By: \_\_\_\_\_

State of: \_\_\_\_\_  
 County of: \_\_\_\_\_  
 Subscribed and sworn to before me this \_\_\_\_\_ day of \_\_\_\_\_

Notary Public: \_\_\_\_\_  
 My Commission expires: \_\_\_\_\_

## ARCHITECT'S CERTIFICATE FOR PAYMENT

In accordance with the Contract Documents, based on on-site observations and the data comprising this application, the Architect certifies to the Owner that to the best of the Architect's knowledge, information and belief the Work has progressed as indicated, the quality of the Work is in accordance with the Contract Documents, and the Contractor is entitled to payment of the AMOUNT CERTIFIED.

AMOUNT CERTIFIED \$ \_\_\_\_\_

*(Attach explanation if amount certified differs from the amount applied. Initial all figures on this application and on the Continuation Sheet that are changed to conform with the amount certified.)*

ARCHITECT: \_\_\_\_\_ Date: \_\_\_\_\_  
 By: \_\_\_\_\_

This Certificate is not negotiable. The AMOUNT CERTIFIED is payable only to the Contractor named herein, issuance, payment and acceptance of payment are without prejudice to any rights of the Owner or Contractor under this Contract.



# Contractor's Affidavit of Payment of Debts and Claims

PROJECT: *(Name and address)*

ARCHITECT'S PROJECT NUMBER:

OWNER

ARCHITECT

CONTRACT FOR:

CONTRACTOR

SURETY

OTHER

TO OWNER: *(Name and address)*

CONTRACT DATED:

STATE OF:

COUNTY OF:

The undersigned hereby certifies that, except as listed below, payment has been made in full and all obligations have otherwise been satisfied for all materials and equipment furnished, for all work, labor and services performed, and for all known indebtedness and claims against the Contractor for damages arising in any manner in connection with the performance of the Contract referenced above for which the Owner or Owner's property might in any way be held responsible or encumbered.

EXCEPTIONS:

SUPPORTING DOCUMENTS ATTACHED HERETO:

- 1 Consent of Surety to Final Payment.  
Whenever Surety is involved, Consent of Surety is required. Consent of Surety, may be used for this purpose.

Indicate Attachment  Yes  No

*The following supporting documents should be attached hereto if required by the owner.*

- 1 Contractor's Release or Waiver of Leins, conditional upon receipt of final payment.
- 2 Separate Releases of Waivers of Leins from Subcontractors and material and equipment suppliers, to the extent required by the Owner, accompanied by a list thereof.

- 3 Contractor's Affidavit of Release of Leins

CONTRACTOR: *(Name and address)*

BY:

\_\_\_\_\_  
*(Signature of authorized representative)*

\_\_\_\_\_  
*(Printed name and title)*

Subscribed and sworn to before me on this date:

Notary Public:

My Commission Expires:

## Contractor's Affidavit of Release of Leins

PROJECT: *(Name and address)*

ARCHITECT'S PROJECT NUMBER:

OWNER

ARCHITECT

CONTRACT FOR:

CONTRACTOR

SURETY

OTHER

TO OWNER: *(Name and address)*

CONTRACT DATED:

STATE OF:

COUNTY OF:

The undersigned hereby certifies that to the best of the undersigned's knowledge, information and belief, except as listed below, the Releases or Waivers of Lein attached hereto include the Contractor, all Subcontractors, all suppliers of materials and equipment, and all performers of Work, labor or services who have or may have leins or encumbrance or the right to assert liens or encumbrances against any property of the Owner arising in any number out of the performance of the Contract referenced above.

EXCEPTIONS:

SUPPORTING DOCUMENTS ATTACHED HERETO:

CONTRACTOR: *(Name and address)*

- 1 Contractor's Release or Waiver of Leins, conditional upon receipt of final payment.
- 2 Separate Releases or Waivers of Leins from Subcontractors and material and equipment suppliers, to the extent required by the Owner, accompanied by a list thereof.

BY:

\_\_\_\_\_  
*(Signature of authorized representative)*

\_\_\_\_\_  
*(Printed name and title)*

Subscribed and sworn to before me on this date:

Notary Public:

My Commission Expires:

## Consent of Surety to Final Payment

PROJECT: *(Name and address)*

ARCHITECT'S PROJECT NUMBER:

OWNER

ARCHITECT

CONTRACT FOR:

CONTRACTOR

SURETY

OTHER

TO OWNER: *(Name and address)*

CONTRACT DATED:

---

In accordance with the provisions of the Contract between the Owner and the Contractor as indicated above, the  
*(Insert name and address of Surety)*

on bond of

*(Insert name and address of Contractor)*

, SURETY,

, CONTRACTOR,

hereby approves of the final payment to the Contractor, and agrees that the final payment to the Contractor shall not relieve the Surety of any of its obligations to

*(Insert name and address of Owner)*

, OWNER,

as set forth in said Surety's bond.

IN WITNESS WHEREOF, the Surety has hereunto set its hand on this date:

*(Insert in writing the month followed by the numeric date and year.)*

---

*(Surety)*

---

*(Signature of authorized representative)*

Attest

(Seal):

---

*(Printed name and title)*



## SECTION 01 3200

### CONSTRUCTION PROGRESS SCHEDULE

#### PART 1 GENERAL

##### 1.01 SECTION INCLUDES

- A. Prepare cost loaded Construction schedule using the critical path method (CPM) demonstrating fulfillment of all contract requirements.
- B. Submittals and Distribution.
- C. Review.
- D. Rain days.
- E. Schedule of Milestones.

##### 1.02 RELATED SECTIONS

- A. Contract: Contract Duration and provisions for liquidated damages.
- B. Section 01 2900 - Applications For Payment: Schedule of values.
- C. Section 01 4000- Quality Control: Inspection and testing reports.

##### 1.03 DEFINITIONS

- A. Critical Path Method (CPM): A method of planning and scheduling a construction project where activities are arranged based on activity relationships and network calculations to determine when activities can be performed and the critical path of the Project.
- B. Critical Path: The longest continuous chain of activities through the network schedule that establishes the minimum overall project duration.
- C. Network Diagram: A graphic diagram of a network schedule, showing the activities and activity relationships.
- D. Activity: A discrete part of a project that can be identified for planning, scheduling, monitoring, and controlling the construction project. Activities included in a construction schedule consume time and resources.
  - 1. Critical activities are activities on the critical path.
  - 2. Predecessor activity is an activity that must be completed before a given activity can be started.
- E. Event: An event is the starting or ending point of an activity.
- F. Milestone: A key or critical point in time for reference or measurement.

- G. Float is the measure of leeway in activity performance.
  - 1. Free float is the amount of time an activity can be delayed without adversely affecting the early start of the following activity.
  - 2. Total float is the measure of leeway in starting or completing an activity without adversely affecting the planned project completion date.
  - 3. Float time shall accrue to the Owner and to the Owner's benefit.

#### **1.04 QUALITY ASSURANCE**

- A. Scheduler: Contractor's personnel or Specialist Consultant to the Contractor specializing in CPM scheduling with three years minimum experience in scheduling construction work of a complexity comparable to this Project, and having use of computer facilities capable of delivering a detailed graphic printout within forty-eight (48) hours of request.
- B. Designate, in writing, an authorized representative who will be responsible for the preparation of the CPM schedule and progress of the project. The Contractor's representative shall have direct project control and complete authority to act on behalf of the Contractor in fulfilling the Construction Schedule requirements.
- C. Within 5 calendar days from Notice of Award, submit demonstration of competence in use of CPM scheduling, including evidence of the use of CPM scheduling as specified above. In the event of failure to satisfy Architect of competence, the Contractor shall be required to employ a qualified CPM consultant to be approved by the Architect.
  - 1. The cost of revision to the CPM schedule, not resulting from authorized contract changes, shall be the responsibility of the Contractor.

#### **1.05 SCHEDULE OF INSPECTIONS AND TESTS**

- A. Provide information regarding tasks requiring special inspection and tests to District's inspection and testing laboratory, as requested.

#### **1.06 CONSTRUCTION SCHEDULE**

- A. Prepare the Construction Schedule using the network analysis diagram system known as the critical path method (CPM). Follow procedures outlined in AGC's "Construction Planning & Scheduling".
  - 1. Proceed with preparation of the network diagram immediately following Notice of Award.
  - 2. Follow the steps necessary to complete development of the network diagram in sufficient time to submit the CPM Schedule so it can be accepted for use no later than 30 days after commencement of the Work.
  - 3. Conduct educational workshops to train and inform key project personnel, including subcontractors' personnel, in proper methods of providing data and using CPM schedule.
  - 4. Establish procedures for monitoring and updating the CPM Schedule and for reporting progress. Use "one working day" as the unit of time.
- B. CPM Schedule Preparation: Prepare a list of all activities involved in the Project. Include a list of activities required to complete the Work. Provide the best data available for generation of the network diagram and the CPM Schedule.
  - 1. Indicate the estimated time duration, sequence requirements, and relationship of each activity in relation to other activities.
  - 2. Indicate estimated times for the following activities to be performed:
    - a. Preparation and processing of submittals.

- b. Purchase of materials.
  - c. Delivery.
  - d. Fabrication.
  - e. Installation.
  3. Include, in the network diagram, separate activities showing:
    - a. Preparation and submittal of shop drawings.
    - b. Architect review of shop drawings, including review and selection of colors.
    - c. Procurement and delivery of materials and equipment.
    - d. Installation and testing of major equipment.
    - e. Required delivery for all Owner supplied, Contractor installed items.
  4. Include a legend showing:
    - a. Each location or area code number and the place or location it refers to.
    - b. Each responsibility or trade code number and the trade or entity it refers to.
  5. Indicate each building or separate area as a separately scheduled element of the Work.
  6. Using the preliminary network diagram, prepare a skeleton network to identify probable critical paths.
  7. Where the work of several trades is combined into one activity, the Contractor shall furnish, for each such combined activity, the cost breakdown of each trade on sheets separate from the network diagram. The sum of the costs for each trade shall equal the total dollar value of each such combined activity.
- C. Submit the following supporting data with the submittal of the original CPM construction schedule. Any changes to this information shall be submitted with successive updates and revisions.
1. The proposed number of working days per week.
  2. The holidays to be observed during the duration of the contract (by day, month, and year).
  3. The planned number of shifts per day.
  4. The number of hours per shift.
  5. The planned usage of major construction equipment on the site, on a monthly basis.
  6. The average weekly manpower usage for each trade to be employed on the project.
- D. Processing: Enter prepared data on the processing system. Process data to produce output data or a computer-drawn, time-scaled network. Revise data, reorganize activity sequences, and reproduce as often as necessary to produce the CPM Schedule within the limitations of Contract Time.
- E. Format: Display the full network on a single sheet of stable transparency, or other reproducible media, of sufficient width to show data clearly for the entire construction period.
1. Mark the critical path. Locate the critical path near the center of the network; locate paths with the most float near the edges.
  2. Sub networks on separate sheets are permissible for activities clearly off the critical path.
- F. Initial Issue: Prepare the initial issue of the CPM Schedule network diagram from a listing of straight "early start-total float" sort. Identify critical activities. Prepare tabulated reports to show the following:
1. The Contractor or subcontractor and Work or activity.
  2. Description of the activity.
  3. Principal events of that activity.
  4. Immediate preceding and succeeding activities.
  5. Early, late and actual start dates.
  6. Early, late and actual finish dates.

7. Activity duration in working days.
  8. Total float and free float time. Float time shall accrue to the Owner and to the Owner's benefit.
  9. Average size of work force.
  10. Monetary value of activity (coordinated with the Schedule of Values).
- G. Value Summaries: Prepare 2 cumulative value listings, sorted by finish dates.
1. In first listing, tabulate the following:
    - a. Activity number.
    - b. Early finish date.
    - c. Dollar value.
    - d. Cumulative dollar value.
  2. In second listing, tabulate the following:
    - a. Activity number.
    - b. Late finish date.
    - c. Dollar value.
    - d. Cumulative value.
  3. In subsequent issues of both listings, substitute actual finish dates for activities completed as of listing date.
- H. Prepare listing for ease of comparison with payment requests: coordinate timing with progress meetings.
1. In both value summary listings, tabulate "actual percent complete" and "cumulative value completed" with total at bottom.
  2. Submit value summary printouts following each regularly scheduled progress meeting.
  3. Provide monthly project cash flow analysis upon District's request at no additional cost.
- I. Sequence the work to enable completion of scopes of work identified in intermediate milestones so that separate contracts can be mobilized prior to completion of this contract. Refer to Article titled MILESTONE SCHEDULE in Part 3 of this Section.

#### **1.07 REVISIONS TO SCHEDULES**

- A. Graphically indicate progress of each activity to date of submittal, and projected completion date of each activity as referenced to the baseline date for that activity as shown in the initial schedule.
- B. Identify activities modified since previous submittal, major changes in scope, and other identifiable changes.
- C. Insert Delay Contingency activities into the critical path at the point where they occur, incorporating the mutually agreed duration per the Article on DELAY CONTINGENCY. Shorten the initial Delay Contingency activity by this mutually agreed duration.
- C. Provide narrative report to define problem areas, anticipated delays, and impact on Schedule. Report corrective action taken, or proposed, and its effect including the effect of changes on schedules of separate contractors.
- D. Revision to the CPM schedule may require reallocation of costs. Revised activity cost data shall be submitted with revised CPM schedules as necessary.

- E. After each monthly update or revision, the Contractor shall submit, to the Architect, one complete set of reproducible transparencies of the last accepted CPM schedule, each marked up in red, showing all revisions and changes in accordance with the monthly review meeting.
- F. Within five (5) working days after receipt of notice from the Architect, the Contractor shall submit a revised CPM schedule for any of the following reasons:
  - 1. When delay in completion of any activity, or group of activities, indicates an overrun of the contract time or milestone requirement by 20 working days or ten percent (10%) of the remaining duration, whichever is less.
  - 2. Delays in submittals or deliveries or work stoppage are encountered which make re-planning or rescheduling of the work necessary.
  - 3. The schedule does not represent the actual prosecution and progress of the project as being performed in the field.

#### **1.08 SUBMITTALS**

- A. Submit initial schedules within fifteen (15) calendar days after date of Owner-Contractor Agreement. After review, resubmit required revised data within five days.
- B. Submit revised Progress Schedules with each Application for Payment. Submittal of revised Progress Schedule is a condition precedent to receipt of Payment.
- C. Submit the number of opaque reproductions which Contractor requires, plus three copies which will be retained by Architect. In addition, submit each schedule submittal, including initial submittal, in the Scheduling software's complete and original software file format on Compact Disc - Read Only (CD-ROM). Provide one such disk with each schedule submittal. Architect will retain CD-ROM electronic versions.
- D. Submit "three-week look ahead" report in bar-chart format indicating activities scheduled to occur in the up-coming two week period. Provide and discuss these submittals at the progress meetings specified in Section 01 3900 and additionally as requested by the Architect, Owner or Inspector.

#### **1.09 PROGRESS REPORTING, UPDATING AND REVISIONS:**

- A. On a date mutually agreed upon by the Architect and the Contractor, a job site progress meeting will be held each month at which time the CPM schedule will be reviewed and updated. Attendees of this meeting shall include the Architect, the General Contractor and subcontractors, if requested by the Architect. The Contractor shall have its copy of the Payment Request form and all other data required by the Contract Documents accurately filled in and completed prior to this meeting. Job Progress and the CPM schedule will be reviewed to verify:
  - 1. Payment due to the Contractor, based on percentage complete of items in the submitted Payment Request form.
  - 2. Logic, time and cost data for change order work that is to be incorporated into the CPM schedule or Payment Request form.
  - 3. Status of as-built record drawings and as-built record specifications.
- B. The Contractor shall submit a narrative report as a part of its monthly progress review and update.

**1.10 REVIEW**

- A. Architect's review is limited to verification of compliance with the Contract start and end dates and inclusion of Contract Time adjustments.
- B. To the extent that the CPM schedule or any revised CPM schedule shows anything not jointly agreed upon, it shall be deemed to have not been accepted by the Architect. Failure to include any element of work required for the performance of this contract shall not excuse the Contractor from completing all work required within any applicable completion date of each phase notwithstanding the Architect's acceptance of the CPM schedule.
- C. Acceptance of any revised CPM schedule and all supporting data is contingent upon compliance with all other paragraphs of this section and any other previous agreements or requirements with or by the Architect.

**1.11 DELAY CONTINGENCY**

- A. Each Contractor submitting a bid proposal shall make allowance in its proposal and Project Schedule for Forty (40) work days for delay to the critical path due to inclement weather or delay due to circumstances beyond the Contractor's control.
- B. Extension of time for delay due to inclement weather or circumstances beyond the Contractor's control will be allowed only in the event that the total number of critical path work days delayed exceeds the number of days allowed in paragraph A of this Article. No time extension will be allowed for delays that do not affect the critical path as set forth in the master schedule.
- C. No time extension will be allowed for inclement weather occurring on any Saturday, Sunday, National or other holiday, including holidays recognized by specific unions, crafts or trades. Exception: If any day defined above is scheduled as a work day under the provisions of the Article CONTRACTOR'S RESPONSIBILITY FOR COMPLETION and approved by the Architect and Owner, or as otherwise approved by the Owner.
- D. A rain day is defined as any day that receives .130" or greater rainfall as reported by a local weather service acceptable to the Architect and is cause for work to be stopped. For the purposes of this project, Rain Days must meet this definition and be mutually approved and agreed upon on the day that a rain day occurs by the Contractor and the Architect. Contractor will post and maintain, in a conspicuous location, a calendar of so-approved rain days at the Contractor's jobsite trailer.

**1.12 CONTRACTOR'S RESPONSIBILITY FOR COMPLETION:**

- A. The Contractor agrees that whenever it becomes apparent from the monthly progress review meeting or the schedule that contract completion dates will not be met, it shall take some or all of the following action at no additional cost to the Owner:
  - 1. Increase construction manpower in such quantities and crafts as will bring the progress of the work into conformance with all other requirements of this section.
  - 2. Increase the number of working hours per shift, shifts per working day, workdays per week, the amount of construction equipment or any combination of the foregoing, to bring the scheduling and progress of the work into conformance with all requirements of the Contract Documents.

3. Reschedule the work under this contract in conformance with all other contract requirements to demonstrate completion of the contract work within the contract time.
- B. Compensate owner for costs incurred to the Owner for rescheduling or additional testing, inspection, or architectural services made necessary by the Contractor's actions.

### **1.13 ADJUSTMENT OF THE CONTRACT TIME:**

- A. The contract time will be adjusted only for causes specified in the Contract Documents. In the event the Contractor requests an adjustment of the contract time, it shall furnish such justification, CPM data and supporting evidence as the Architect may deem necessary for a determination as to whether or not the Contractor is entitled to an adjustment of time under the provisions of the contract. Submission of proof based on revised activity logic, duration and cost is obligatory with any request. Requests not conforming to these requirements are deemed to be waived.
- B. The Contract Time will be not be adjusted for any reason, including weather, until the latest accepted schedule clearly displays that the Contractor has used, in full, all the float time available for the Work. Delays in activities which, according to the latest accepted schedule, are not on the critical path in the CPM schedule will not be the basis for an adjustment to the contract time.
- C. The Contractor shall submit each request for an adjustment in the contract time to the Architect in accordance with all other requirements of the Contract Documents. The Contractor shall include, as part of each request:
1. Justification for the delay in narrative form.
  2. A sub network showing all CPM logic revisions, duration changes and cost changes for the work in question and its relationship to other activities on the CPM schedule.
- D. The Architect's determination as to the adjustment of the contract time shall be based upon the latest schedule which has been accepted at the time of the alleged delay and all other relevant information. The Contractor shall submit with every request, an updated CPM schedule whenever the actual field progress of the work does not conform to the accepted schedule in force at the time of the alleged delay. The CPM data, if accepted by the Architect, shall be included in the next monthly updating of the schedule.
- E. The Architect shall, within a reasonable time after receipt of a request and supporting evidence for extension of the contract time, review the facts and shall advise the Contractor, in writing, of its decision.

### **1.14 DISTRIBUTION**

- A. Distribute copies of reviewed schedules to Project site file, Subcontractors, suppliers, and other concerned parties.
- B. Instruct recipients to promptly report, in writing, problems anticipated by projections indicated in schedules.
- C. Architect will distribute copies to the Owner and the Inspector.

## **PART 2 PRODUCTS**

### **2.01 SCHEDULING SYSTEMS**

- A. Prepare schedules using professional quality scheduling software systems designed for this purpose, capable of producing results specified.
- B. Acceptable products:
  - 1. Primavera Systems
  - 2. Microsoft Project

**PART 3 EXECUTION**

**3.01 MILESTONES**

Milestone 1: Completion of Building B and surrounding site work. July 1, 2021.

Milestone 2: Project Completion: December 15, 2021.

Milestone 3: Completion of Building A. March 31, 2022.

**END OF SECTION**



## SECTION 01 3300

### SUBMITTALS

#### PART 1 GENERAL

##### 1.01 SECTION INCLUDES

- A. Submittals required by the Contract Documents. Revise and re-submit as necessary to establish compliance with Contract Documents.
  - 1. It is reasonable that the Contractor will provide a satisfactory submittal by the second submittal. If repeated resubmittals are required, the Owner may "back charge" the Contractor for the cost of review and processing.

##### 1.02 WORK NOT INCLUDED

- A. Submittals which are not required will not be reviewed by the Architect.
- B. The Contractor may require subcontractors to provide drawings, setting diagrams or similar information as part of the coordination of the Work. The Architect will not review this data.

##### 1.03 RELATED WORK

- A. Section 01 3200 - Construction Schedules: Dates for submission and dates that reviewed submittals will be required shall be designated in the Construction Schedule.
- B. Section 01 7000 - Contract Closeout: Project record documents.

##### 1.04 QUALITY ASSURANCE

- A. Submit to the Architect for review, product literature, samples and shop drawings as specified or required to fully describe every item proposed for incorporation in the work. Only approved items may be used.
- B. Prior to submittal, review and coordinate all aspects of each item. Verify that each item and it's submittals conform to Contract Document requirements. Contractor assumes full responsibility for coordinating and verifying information, quantities and dimensions shown in submittals.
- C. Submittals shall include:
  - 1. Date and revision dates.
  - 2. Project title and number.
  - 3. The names of:
    - a. Architect/Engineer.
    - b. Contractor.
    - c. Subcontractor.
    - d. Supplier.
    - e. Manufacturer.
    - f. Separate detailer when pertinent.
  - 4. Identification of product or material.

5. Relation to adjacent structure or materials.
  6. Field dimensions, clearly identified as such.
  7. Specification section number.
  8. Applicable standards, such as ASTM number or Federal Specification.
  9. A blank space, 8 inches x 3 inches, for the Contractor and Architect stamps.
  10. Identification of deviations from Contract Documents.
  11. Contractor's stamp, initialed or signed, certifying to review of submittal, verification of field measurements and compliance with Contract Documents.
  12. Signature of and calculations by an engineer, licensed in California, where required by specifications.
- D. Indicate review and approval of each submittal prior to transmittal to Architect by affixing Contractor's stamp, initialed or signed, certifying:
1. Review of submittal
  2. Verification of compliance with requirements of the Contract Documents.
  3. Verification of compatibility with other submittals, shop drawings, substitutions, and work of other trades.
  4. Coordination with existing job conditions and field construction criteria.
  5. Field verification of dimensions.
- E. Architect will review Contractor's stamp language. Revise language in accordance with Architect's comments and provide new stamp if required by Architect.
- F. Architect will return unreviewed any submittal not stamped by the Contractor in accordance with the above.
- G. Direct Architect's attention to any deviations from the Contract Documents . Deviations not so noted shall be considered unreviewed.
- H. Direct Architect's attention to any changes made in submittals other than those specifically requested by Architect. Changes not so noted shall be considered unreviewed.
- I. Work shall not be fabricated, nor material shipped to project site prior to the distribution of approved submittals from the Architect.

#### **1.05 SUBMITTALS**

- A. Make submittals of shop drawings, product data, samples, substitution requests, meeting minutes and other items required by the Contract Documents in accordance with the provisions of this Section.
- B. Submittals shall include all technical and performance data necessary for the Architect to properly evaluate the submittal. Provide physical samples if requested by Architect, whether expressly specified or not.
- C. Incomplete submittals will be return to the Contractor without review. Contractor shall be responsible for delays incurred by incomplete, multiple reviews or rejected submittals.
- D. Provide only one make or brand of any product proposed.

## **PART 2 PRODUCTS**

### **2.01 SHOP DRAWINGS**

- A. Shop drawings are to be drawn at large scale, fully detailed and with all materials and stock or purchased components fully identified. Shop drawings are to be submitted when specified and to illustrate every custom fabricated item or assembly.
- B. Types of prints required: See 3.01 ELECTRONIC SUBMITTAL PROCEDURES.
- C. Drawings are to be identified showing the project name, the Owner's name and account number, the Architect's name and job number, the Contractor's name and the specification section number and drawing detail reference number relating to the work shown.

### **2.02 PRODUCT DATA**

- A. Submit detailed technical literature fully describing every product or item proposed for use including manufacturers and items specified. Include manufacturer's detailed specifications, drawings, photographs, performance criteria, installation instructions, test data, samples of colors and finishes and other information required to fully describe the item.
  - 1. Modify standard product data to delete information which is not pertinent.
  - 2. Provide additional information which is specifically applicable.
- B. Mark all submittals indicating items, options, and finishes proposed, and referencing project specification section and paragraph covering the work in question. Indicate as follows:
  - 1. Performance characteristics and capacities.
  - 2. Dimensions and/or clearances required.
  - 3. Wiring, piping and control diagrams.

### **2.03 SAMPLES**

- A. Samples shall be identical to the precise article proposed, illustrating functional characteristics with all related parts and attachments. Indicate full range of color, textures and patterns.
- B. Samples shall be identified by attaching a label on unexposed side of Samples that include the following:
  - 1. Generic Description of Sample.
  - 2. Product name and name of manufacturer.
  - 3. Number and title of applicable Specification Section.
- C. Submit number of samples as indicated above. Where samples of large complete items such as light fixtures, hardware, etc. are required, one sample will suffice and that will be returned to the Contractor after review.

### **2.04 COLORS AND PATTERNS**

- A. Submit color and pattern selections for all products offering a choice of these attributes unless a specific color or pattern is referenced in the Contract Documents.

- B. Submit within thirty five (35) days of Notice of Award a list of all required color selections organized by product, including manufacturer and model. Include samples of manufacturer's complete color range for all products.
- C. Architect will not select colors or patterns until samples of all items requiring selections have been submitted. Architect will not make partial color selections.
- D. Failure to submit all color selections as specified above, thus requiring additional unanticipated time for the Architect to make selections will not be basis for extension of Contract Time.
- E. Architect will make color selections within 30 working days following complete submittal of samples. This time will commence with the receipt of the latest incremental submittal, as applicable.
- F. Architect will issue Color Schedule.

### **PART 3 EXECUTION**

#### **3.01 ELECTRONIC SUBMITTAL PROCEDURES**

- A. Submittals shall be transmitted to the Architect in electronic, editable (PDF) format using the project's cloud-based file sharing and storage service ("project's website"). The cloud-based file sharing and storage service will be selected by the Architect. Contractor's failure to utilize, provide entries and processing through the Architect's cloud-based system will subject Contractor to hourly back charges associated with efforts required by others to perform work which is the contractual responsibility of the Contractor.
- B. Contractor's cost related to the use of the project's website services shall be included in the Contractor's bid.
- C. The electronic submittal process is not intended for color samples, color charts, or physical material samples.
- D. For the shop drawings larger than 11' x 17' size and Deferred Approvals, submit (3) hardcopies to the Architect and also submit electronically on the project's website. Provide additional hardcopies, as requested by Architect.
- E. Provide hardcopy submittals if requested by Architect.
- F. The Architect's review comments will be made available on the project's website for downloading.
- G. Contractor will distribute a hardcopy of all reviewed submittals to the Inspector of Record, Owner, and Construction Manager.

#### **3.02 ADMINISTRATION REQUIREMENTS**

- A. Name electronic file using the following identifiers, separated by dashes: consecutive submittal number, specification section number, revision number (if needed), and a brief description of the submittal contents; example: 15-05 5000-0 Metal Fabrications.
- B. Write sequential page numbers at bottom of each page of submittal. On submittal cover sheet, provide brief description for product and coinciding page numbers; example: Pages 5-23 Metal Fabricated Gate Shop Drawings.
- C. Provide the following on the submittal cover sheet:
  1. Project title and project number.
  2. Date.
  3. Submittal number.
  4. The name of:
    - a. Architect/Engineer.
    - b. Contractor.
    - c. Subcontractor.
    - d. Supplier.
    - e. Manufacturer.
    - f. Separate detailer when pertinent.
  5. Identification of product or material and page numbers.
  6. Submittal number, as described in 3.03.
  7. A blank space, 8 inches x 3 inches, for the contractor and Architects stamps.
  8. Contractor's stamp, initialed or signed, certifying to review of submittal, verification of field measurements, and compliance with Contract Documents.
- D. Unless otherwise indicated in technical specifications, not less than 15 days following Notice of Award, submit a complete submittal register utilizing spreadsheet provided by Architect. The architect provided submittal register is a template including most potential submittal items. Contractor shall strike through any submittal items not intended for submittal and highlight any revisions or additions to the template provided. All columns of information shall be filled out in full. Contractor shall then return edited spreadsheet to Architect for review. Spreadsheet format must not be altered to allow insertion into project data base. Once reviews are complete, the Architect will upload the submittal register into the project data base for all party's utilization.

### **3.03 IDENTIFICATION OF SUBMITTALS**

- A. Number submittals consecutively. Each specification section requiring submittal must at a minimum have one unique submittal number. **DO NOT GROUP MULTIPLE SPECIFICATION SECTION ITEMS UNDER ONE SUBMITTAL NUMBER.** Refer to submittal by this number in subsequent correspondence and submittals.
  1. Transmit re-submittals under new cover. Use submittal number of original submittal with revision number suffix. Cite original submittal number for reference.
  2. Do not transmit new submittals with alphabetic suffix.

- B. Transmittal letter for each submittal shall show all information required for identification and checking.
- C. Include submittal number on first page and elsewhere as required for identification.
- D. Maintain log of submittals and status. Furnish copies to the Architect and Inspector upon request.

#### **3.04 GROUPING OF SUBMITTALS**

- A. Transmit submittals in groups containing all associated items to ensure availability of information during review. However, each specification section must bear unique submittal number.
- B. Incomplete or partial submittals may be returned for enhancement. No extension of time will be allowed for delays related to incomplete submittals.

#### **3.05 SCHEDULING OF SUBMITTALS**

- A. Transmit submittals sufficiently in advance of installation for required review, revisions, re-submittals and delivery. Include time required for transmittal by regular mail between the parties involved. No extension of time will be allowed for delays related to late submittals.
- B. Deferred approval submittals are subject to long lead times. Schedule submittals accordingly.

#### **3.06 ARCHITECT'S REVIEW OF SUBMITTALS**

- A. Submittals will be reviewed and stamped by the Architect "No exceptions taken," "Submit specified item" or "Make corrections noted" to indicate full or conditioned approval or "Revise and resubmit" or "Rejected" to indicate disapproval. Terms are defined as follows:
  - 1. No Exceptions Taken: Accepted subject to its compatibility with future submittals and additional partial submittals for portions of the work not covered in this submittal. Does not constitute approval or deletion of specified or required items not shown in the partial submittal.
  - 2. Submit specified item: Submit to the Architect the items indicated for review.
  - 3. Correct as noted: Same as 1., except that minor corrections as noted shall be made by the Contractor. No resubmittal required.
  - 4. Revise and resubmit: Rejected because of major inconsistencies or errors which shall be resolved or corrected by the Contractor prior to subsequent review by the Architect.
  - 5. Rejected: Submitted material does not conform to plans and specifications in major respect. For example, wrong size, model, capacity or material. Resubmit.
  - 6. Receipt Acknowledged. Received, recorded and distributed without further action.
- B. Submittals reviewed by the Architect which have been stamped shall be deemed to have the following language affixed and made a part thereof, regardless of the initial or subsequent readability of the actual stamp.

1. Corrections or comments made on submittals during this review do not relieve the contractor from compliance with the requirements of the drawings and specifications. This check is for review of general conformance with the design concept of the project and general compliance with information given in the Contract Documents. The contractor is responsible for confirming and correlating all quantities and dimensions, selection of fabrication processes and techniques of construction, coordinating the work of the trades; and performing the work in a safe and satisfactory manner.
- C. Architect's review of submittals shall be undertaken with reasonable promptness, while allowing sufficient time in the Architect's professional judgment to permit adequate review.
- E. Architect's review of submittals has, as a primary objective, to assist in the completion of the project on time and in conformance with the Contract requirements by permitting review of material and fabricated items prior to ordering. Architect's review of submittals is based only on the data presented and extends only to conformance with general design intent and information contained in the Contract Documents.
- E. Architect's approval of submittals does not constitute final acceptance or unqualified approval of items or work proposed or put in place, nor does it constitute acceptance of responsibility for the accuracy, coordination or completeness of submittals. Architect's approval of submittals does not relieve the Contractor from the responsibility for errors, omissions, or compliance with all the requirements of the Contract Documents.
- F. Reimbursement of the Architect's costs for review:
  1. Architect will record all time and expenses incurred to review submittals requiring more than two reviews.
  2. Contractor shall reimburse the District through deduction from amounts due the Contractor upon receipt of the Architect's billing and that of the Architect's consultants at standard billing rates for all time and expenses incurred in unanticipated reviews.
- G. Architect's review of submittals does not change the Contract in any manner.

### **3.07 RESUBMITTAL**

- A. Make all corrections or revisions required by reviewer's comments at Contractor's expense and resubmit as initially specified above. No additional costs will be authorized for corrections or revisions.
- B. Product data and shop drawings:
  1. Revise initial drawings or data and resubmit as initially specified.
  2. Indicate changes which have been made other than those requested by reviewer.
- C. Submit new samples as initially specified.

### **3.08 DEFERRED APPROVAL**

- A. Items so designated in the Contract Documents are subject to deferred approval review by the Division of the State Architect (DSA).

- B. Not less than 15 days following Notice of Award, submit all items specified for deferred approval complete with all structural calculations, test data and information as specified or as subsequently required by the reviewing agency, including original engineering stamps and original signatures as required. Architect shall submit to DSA only following Architect/Engineer review.
  - 1. The Architect will not approve deferred approval submittals until they are approved by DSA.
- C. No work or fabrication shall begin until DSA approved submittals are distributed to the Contractor.
- D. Contractor is notified that significant lead time is required for deferred approval review by DSA and shall schedule work accordingly. No extension of Contract Time will be allowed for delays incurred by deferred approval review.
  - 1. The Architect is not responsible for DSA delays in deferred approval review.

### **3.09 DISTRIBUTION**

- A. Distribute only submittals with Architect/Engineer (and DSA as applicable) stamps of review. Contractor is responsible for coordination of submittals and comments following review. Contractor to provide all additional reproduction costs for copies required by the Contractor at its expense. No additional costs will be authorized for Contractor costs pertaining to submittals.

**END OF SECTION**



## SECTION 01 3546

### CONSTRUCTION INDOOR AIR QUALITY MANAGEMENT PLAN

#### PART 1 - GENERAL

##### 1.01 RELATED DOCUMENTS

- A. Drawings and general provisions of the Contract, including General and Supplementary Conditions and other Division 01 specification sections, apply to this section.

##### 1.02 SECTION INCLUDES

- A. Description of a construction Indoor Air Quality (IAQ) Management Plan.
- B. IAQ construction requirements.

##### 1.03 RELATED SECTIONS

- A. Section 01 6116 - VOC Restrictions.
- B. Section 23 0593 - Testing, Adjusting, and Balancing for HVAC: Additional requirements for baseline testing for IAQ.
- C. Section 23 0593- Testing, Adjusting, and Balancing for HVAC: Cleaning of HVAC system including ductwork, air intakes and returns, and changing of filters.

##### 1.04 REFERENCES

- A. American Society of Heating, Refrigerating and Air-Conditioning Engineers, Inc. (ASHRAE):
  - 1. ASHRAE Standard 52.1-1992, Gravimetric and Dust Spot Procedures for Testing Air Cleaning Devices in General Ventilation for Removing Particulate Matter.
- B. ASTM International (ASTM):
  - 1. ASTM D5116-97, Standard Guide for Small-Scale Environmental Chamber Determinations of Organic Emissions from Indoor Materials/Products.
- C. Sheet Metal and Air Conditioning National Contractors Association (SMACNA):
  - 1. IAQ Guidelines for Occupied Buildings under Construction, 1995.

##### 1.05 INDOOR AIR QUALITY

- A. Goals: The Owner has set the following indoor air quality goals for jobsite operations on the project, within the limits of the construction schedule, Contract Sum, and available materials, equipment, products and services. Goals include:
  - 1. Protect workers on the site from undue health risks during construction.
  - 2. Prevent residual problems with indoor air quality in the completed building.

##### 1.06 SUBMITTALS

- A. Indoor Air Quality Plan: Within 14 days after receipt of Notice to Proceed and prior to any waste removal from the project, develop and submit for review a healthy indoor air quality plan. The plan shall include:
  - 1. List of IAQ protective measures to be instituted on the site.
  - 2. Schedule for inspection and maintenance of IAQ measures.

#### **1.07 QUALITY ASSURANCE**

- A. Perform material tests and report results in accordance with ASTM D5116.

### **PART 2 - PRODUCTS**

#### **2.01 SUBSTITUTIONS**

- A. Should the Contractor desire to use procedures, materials, equipment, or products that are not specified but meet the intent of the specifications to protect indoor air quality on the site, the Contractor shall propose these substitutions in accordance with Section 01 6000.

#### **2.02 MATERIALS**

- A. Low emitting products have been specified in appropriate sections.

### **PART 3 - EXECUTION**

#### **3.01 CONSTRUCTION IAQ MANAGEMENT PLAN**

- A. Meet or exceed the minimum requirements of the Sheet Metal and Air Conditioning National Contractors Association (SMACNA) "IAQ Guidelines for Occupied Buildings Under Construction."
  - 1. Protect the ventilation system components from contamination, OR provide cleaning of the ventilation components exposed to contamination during construction prior to occupancy.
  - 2. Provide a continuous ventilation rate of one (1) air change per hour minimum during construction, OR, conduct a building flush-out with new filtration media at 100 percent outside air after construction ends (following issuance of a Certificate of Occupancy) and prior to occupancy for seven (7) days. Provide a minimum of 85 percent filtration (as determined by ASHRAE Standard 52.1 on any return air systems that are operational during construction, and replace filtration media prior to occupancy.
- B. During installation of carpet, paints, furnishings, and other VOC-emitting products, provide supplemental (spot) ventilation for at least 72 hours after work is completed. Preferred HVAC system operation uses supply air fans and ducts only; exhaust provided through windows. Use exhaust fans to pull exhaust air from deep interior locations. Stair towers and other paths to exterior can be useful during this process.
- C. Conduct regular inspection and maintenance of indoor air quality measures including ventilation system protection, and ventilation rate.
- D. Require VOC-safe masks for workers installing VOC-emitting products (interior and exterior) defined as products that emit 150 gpl or more UNLESS local jurisdiction's requirements are stricter, in which case the strictest requirements shall be followed for use of VOC-safe masks.

- E. Use low-toxic cleaning supplies for surfaces, equipment, and worker's personal use. Options include several soybean-based solvents and cleaning options (SOYsolv) and citrus-based cleaners.
- F. Use wet sanding for gypsum board assemblies. Exception: Dry sanding allowed subject to Architect's approval of the following measures:
  - 1. Full isolation of space undergoing finishing.
  - 2. Plastic protection sheeting is installed to provide air sealing during sanding.
  - 3. Closure of all air system devices and ductwork.
  - 4. Sequencing of construction precludes the possibility of contamination of other spaces with gypsum dust.
  - 5. Worker protection is provided.
- G. Use safety meetings, signage, and [sub] contractor agreements to communicate the goals of the construction indoor air quality plan.

END OF SECTION

## SECTION 01 3900

### COORDINATION AND MEETINGS

#### PART 1 GENERAL

##### 1.01 SECTION INCLUDES

- A. Coordination and project conditions.
- B. Related work.
- C. Discrepancies.
- D. Examination.
- E. Pre-Contract meeting.
- F. Pre-construction meeting.
- G. Site mobilization meeting.
- H. Progress meetings.
- I. Pre-installation meetings.
- J. Project coordination meetings.

##### 1.02 COORDINATION AND PROJECT CONDITIONS

- A. Coordinate scheduling, submittals, and Work of the various portions of the Contract Documents to assure efficient and orderly sequence of installation of interdependent construction elements.
- B. Coordinate hours and days of Work with local ordinances and requirements.
- C. Verify utility requirements and characteristics of operating equipment are compatible with building utilities. Coordinate work of various sections having interdependent responsibilities for installing, connecting to, and placing in service, such equipment.
- D. Coordinate space requirements, supports, and installation of mechanical and electrical Work which are indicated diagrammatically on Drawings. Follow routing shown for pipes, ducts, and conduit, as closely as practicable; place runs parallel with lines of building. Utilize spaces efficiently to maximize accessibility for other installations, for maintenance, and for repairs.
- E. In finished areas except as otherwise indicated, conceal pipes, ducts, and wiring within the construction. Coordinate locations of fixtures and outlets with finish elements.

- F. Coordinate completion and cleanup of Work of separate sections in preparation for Substantial Completion.
- G. After Owner occupancy of premises, coordinate access to site for correction of defective Work and Work not in accordance with Contract Documents, to minimize disruption of Owner's activities.
- H. Contractor shall coordinate Work with work to be performed by separate contractors as listed in Section 01 1100 - Summary of Work.

### **1.03 RELATED WORK**

- A. Referencing specification sections in "Related Work" articles is for convenience only and shall not be construed as to limit the coordination of the Contract Documents to referenced sections.
- B. Documents affecting the work of any section include, but are not limited to, General Conditions, Supplementary General Conditions, and Sections in Division 01 of these Specifications.
- C. Work in any section may relate to other work in these documents. The Contractor is responsible to coordinate all work.

### **1.04 DISCREPANCIES**

- A. In the event of discrepancy in the Contract Documents or if uncovered conditions are not as anticipated, immediately notify the Architect and secure needed direction.
- B. Do not proceed in areas of discrepancy until such discrepancies have been fully resolved.
- C. Before starting work, verify governing dimensions at the premises, and examine adjoining work on which this work is dependent. No "Extra" or additional compensation will be allowed on account of differences between actual measurements and dimensions shown. Submit differences discovered during the work to Architect for interpretation before proceeding with the associated work.
- D. Any time extension or any increase or decrease of cost resulting from such changes will be adjusted in the manner provided in the General Conditions.

### **1.05 EXAMINATION**

- A. Verify that existing site conditions and substrate surfaces are acceptable for subsequent Work. Beginning new Work means acceptance of existing conditions.
- B. Examine and verify specific conditions described in individual specification sections.
- C. Verify that utility services are available, of the correct characteristics, and in the correct location.

### **1.06 PRE CONTRACT MEETING**

- A. Architect will schedule a meeting with District and apparent low bidder prior to award of Contract.

- B. Attendance Required: Owner, Architect, and Contractor.
- C. Agenda: Execution of the Notice of Award, Review of documents required for Preconstruction Meeting.

#### **1.07 PRECONSTRUCTION MEETING**

- A. Architect will schedule a meeting after Notice of Award.
- B. Attendance Required: Owner, Architect and Contractor.
- C. Agenda:
  - 1. Execution of Owner-Contractor Agreement.
  - 2. Submission of executed bonds and insurance certificates.
  - 3. Distribution of Contract Documents.
  - 4. Submission of schedule of values.
  - 5. Designation of personnel representing the parties in Contract, and the Architect/Engineer.
  - 6. Procedures and processing of field decisions, submittals, substitutions, applications for payments, proposal request, Change Orders, and Contract closeout procedures.
  - 7. Scheduling.
  - 8. Scheduling activities of DSA Inspector of Record.
- D. Architect will record minutes and distribute copies within five days after meeting to participants, and those affected by decisions made.

#### **1.08 SITE MOBILIZATION MEETING**

- A. Architect will schedule a meeting at the Project site prior to Contractor occupancy.
- B. Attendance Required: Owner, Architect, Special Consultants, Contractor, Contractor's Superintendent and major Subcontractors.
- C. Agenda:
  - 1. Use of premises by Owner and Contractor.
  - 2. Owner's requirements and partial occupancy.
  - 3. Construction facilities and controls provided by Owner.
  - 4. Temporary utilities provided by Owner.
  - 5. Security and housekeeping procedures.
  - 6. Schedules.
  - 7. Application for payment procedures.
  - 8. Procedures for testing.
  - 9. Procedures for maintaining record documents.
  - 10. Requirements for start-up of equipment.
  - 11. Inspection and acceptance of equipment put into service during construction period.
- D. Architect will record minutes and distribute copies within five days after meeting to participants, and those affected by decisions made

#### **1.09 PROGRESS MEETINGS**

- A. Schedule and administer meetings throughout progress of the Work at bi-weekly intervals. Provide and discuss “three-week look ahead” schedule reports at these progress meetings. Coordinate progress payments and revised schedule, to monthly meeting attended by an officer of the construction company.
- B. Make arrangements for meetings, prepare agenda with copies for participants and preside at meetings.
- C. Attendance Required: Job Superintendent, major Subcontractors and suppliers, Owner, Inspector of Record and Architect as appropriate to agenda topics for each meeting.
- D. Architect will record minutes and distribute copies within five days after meeting to participants, including Owner, Contractor, and those affected by decisions made.

#### **1.10 PREINSTALLATION MEETING**

- A. When required in individual specification sections, convene a pre-installation meeting at the site prior to commencing work of the section.
- B. Require attendance of parties directly affecting, or affected by, work of the specific section.
- C. Notify Architect four days in advance of meeting date.
- D. Prepare agenda and preside at meeting:
  - 1. Review conditions of installation, preparation and installation procedures.
  - 2. Review coordination with related work.
- E. Architect will record minutes and distribute copies within five days after meeting to participants, with copies to Owner, Contractor and participants.

#### **1.11 PROJECT COORDINATION MEETINGS**

- A. Contractor will schedule project coordination meetings to be held weekly.
- B. Attendance Required: Contractor, job superintendent, Subcontractors, as required.
- C. Contractor will prepare agenda and preside at meeting.
- D. Contractor will record minutes and distribute copies within five days after meeting to participants, Architect and those affected by decisions made.
- E. Copies of the minutes to Architect are required as part of submission of Application for Payment.

### **PART 2 PRODUCTS**

Not Used.

### **PART 3 EXECUTION**

Not Used.

**END OF SECTION**

**SECTION 01 4000**

**QUALITY CONTROL**

**PART 1 GENERAL**

**1.01 SECTION INCLUDES**

- A. Quality assurance - control of installation.
- B. Tolerances.
- C. References.
- D. Mockup.
- E. Inspecting and testing laboratories services.
- F. Manufacturers' field services and reports.
- G. Field engineering and staking.

**1.02 RELATED SECTIONS**

- A. Section 01 4200- Reference Standards.
- B. Section 01 3300 - Submittals: Submission of manufacturers' instructions and certificates.
- B. Section 01 4523 - Testing and Inspection Services.
- C. Section 09 0512 - Concrete Floor Moisture Content & pH Testing.
- E. Section 01 6000 - Material, Equipment and Substitutions: Requirements for material and product quality.
- F. Section 01 7000 - Contract Closeout.

**1.03 QUALITY ASSURANCE - CONTROL OF INSTALLATION**

- A. Monitor quality control over suppliers, manufacturers, Products, services, site conditions, and workmanship, to produce Work of specified quality.
- B. Correct conditions or workmanship not in conformance with specified standards or quality.
- C. Comply with manufacturers' instructions, including each step in sequence.
- D. Should manufacturers' instructions conflict with Contract Documents, request clarification from Architect/Engineer before proceeding.



- E. Comply with specified standards as minimum quality for the Work except where more stringent tolerances, codes, or specified requirements indicate higher standards or more precise workmanship.
- F. Perform Work by persons qualified to produce required and specified quality.
- G. Secure Products in place with positive anchorage devices designed and sized to withstand stresses, vibration, physical distortion, or disfigurement.

#### **1.04 TOLERANCES**

- A. Monitor tolerance control of installed Products to produce acceptable Work. Do not permit tolerances to accumulate.
- B. Comply with manufacturers' tolerances. Should manufacturers' tolerances conflict with Contract Documents, request clarification from Architect/Engineer before proceeding.
- C. Adjust Products to appropriate dimensions; position before securing Products in place.

#### **1.05 REFERENCES**

- A. For Products or workmanship specified by association, trade, or other consensus standards, comply with requirements of the standard, except when more rigid requirements are specified or are required by applicable codes.
- B. Conform to reference standard by date of issue current on date of Contract Documents, except where a specific date is established by code.
- C. Obtain copies of standards where required by product specification sections.
- D. The contractual relationships, duties, and responsibilities of the parties in Contract or those of the Architect/Engineer shall not be altered from the Contract Documents by mention or inference otherwise in any reference document.

#### **1.06 MOCK-UP**

- A. Tests will be performed under provisions identified in this section and identified in the respective product specification sections.
- B. Assemble and erect specified items with specified attachment and anchorage devices, flashings, seals, and finishes.
- C. Accepted mock-ups are representative of the quality required for the Work.
- D. Where mock-up has been accepted by Architect/Engineer and is specified in product specification sections to be removed; remove mock-up and clear area when directed to do so.

#### **1.07 TESTING AND INSPECTION AGENCY SERVICES**

- A. Owner will appoint, employ, and pay for specified services of an independent Testing and Inspection Agency to perform inspecting and testing. Inspections and Testing will be performed in accordance with Section 01 4523 - Testing and Inspection Services; and the General Conditions.

**1.08 MANUFACTURERS' FIELD SERVICES**

- A. When specified in individual specification sections, require material or Product suppliers or manufacturers to provide qualified staff personnel to observe site conditions, conditions of surfaces and installation, quality of workmanship and to initiate instructions when necessary.

**1.09 FIELD ENGINEERING AND STAKING**

- A. Each Contractor awarded Work for this Project shall provide all necessary surveying, layout, lines and grades required for the proper location of the Work.
- B. Contractor agrees to provide any and all false-work, templates, batter-boards and other such structures or devices necessary to provide for the Contractor's layout, lines and grades. Work installed in an incorrect location or elevation shall be removed and re-installed at the expense of the Contractor.

**PART 2 PRODUCTS**

Not Used.

**PART 3 EXECUTION**

Not Used.

## SECTION 01 4200

### REFERENCE STANDARDS

#### PART 1 GENERAL

##### 1.01 RELATED DOCUMENTS

- A. Drawings and general provisions of contract, including General and Supplementary Conditions and other Division 01 Specification sections, apply to work of this section.

##### 1.02 DESCRIPTION OF REQUIREMENTS

- A. General: This section specifies procedural and administrative requirements for compliance with governing regulations and the codes and standards imposed upon the work. These requirements include the obtaining of permits, licenses, inspections, releases and similar documentation, as well as payments, statements and similar requirements associated with regulations, codes, and standards.
  - 1. "Regulations" is defined to include laws, statutes, ordinances and lawful orders issued by governing authorities, as well as those rules, conventions and agreements within the construction industry which effectively control the performance of the work regardless of whether they are lawfully imposed by governing authority or not.
- B. Governing Regulations: Refer to General and Supplementary Conditions for requirements related to compliance with governing regulations.

##### 1.03 DEFINITIONS

- A. General Explanation: A substantial amount of specification language constitutes definitions for terms found in other contract documents, including the drawings. (Drawings must be recognized as diagrammatic in nature and not completely descriptive of the requirements indicated thereon.) Certain terms used in contract documents are defined in this article. Definitions and explanations of this section are not necessarily either complete or exclusive, but are general for the work to the extent they are not stated more explicitly in another element of contract documents.
- B. General Requirements: The provisions or requirements of Division 01 sections apply to entire work of Contract and, where so indicated, to other elements which are included in project.
- C. Indicated: The term "indicated" is a cross-reference to graphic representations, notes or schedules on drawings, to other paragraphs or schedules in the specifications, and to similar means of recording requirements in contract documents. Where terms such as "shown," "noted," "scheduled," and "specified" are used in lieu of "indicated," it is for purpose of helping reader locate cross-reference, and no limitation of location is intended except as specifically noted.

- D. Directed, Requested, Etc.: Where not otherwise explained, terms such as "directed," "requested," "authorized," "selected," "approved," "required," "accepted," and "permitted" mean "directed by Architect/Engineer," "requested by Architect/Engineer," and similar phrases. However, no such implied meaning will be interpreted to extend the Architect's/Engineer's responsibility into the Contractor's area of construction supervision.
- E. Approve: Where used in conjunction with Architect's/Engineer's response to submittals, requests, applications, inquiries, reports and claims by Contractor, the meaning of term "approved" will be held to limitations of Architect's/Engineer's responsibilities and duties as specified in General and Supplementary Conditions. In no case will "approval" by Architect/Engineer be interpreted as a release of Contractor from responsibilities to fulfill requirements of contract documents.
- F. Project Site: The term "project site" is defined as the space available to Contractor for performance of the work. The extent of project site is shown on the drawings, and may or may not be identical with the description of land upon which the project is to be built.
- G. Furnish: Except as otherwise defined in greater detail, term "furnish" is used to mean supply and deliver to project site, ready for unloading, unpacking, assembly, installation, etc., as applicable in each instance.
- H. Install: Except as otherwise defined in greater detail, term "install" is used to describe operations at project site including unloading, unpacking, assembly, erection, placing, anchoring, applying, working to dimension, finishing, curing, protecting, cleaning and similar operations, as applicable in each instance.
- I. Provide: Except as otherwise defined in greater detail, term "provide" means furnish and install, complete and ready for intended use, as applicable in each instance.
- J. Installer: The term "installer" is defined as the entity (person or firm) engaged by Contractor, or its subcontractor or subcontractor for performance of a particular unit of work at the project site, including installation, erection, application and similar required operations. It is a general requirement that such entities (installers) be expert in operations they are engaged to perform.
- K. Testing Laboratory: The term "testing laboratory" is defined as an independent entity engaged to perform specific inspections or tests of the work, either at project site or elsewhere; and to report and (if required) interpret results of those inspections or tests.
- L. Products: The term "products" includes materials, systems and equipment.
- M. Approved Equal, Or Equal: means as approved and accepted by the Architect.
- N. Shall: The term "shall" is mandatory.
- O. As Required, As Necessary, etc.: Words of similar import mean as required by the Contract Documents or essential to the completion of the Work.
- P. Concealed: The term "concealed" means as embedded in masonry or other construction, installed within furred spaces, within double partitions or above suspended ceilings, in trenches, in crawl spaces, or in enclosures.

- Q. Exposed: The term "exposed" means not installed underground or "concealed" as defined above, including work and surfaces open in whole or in part to the exterior or weather.
- R. Work: The term "work" shall include both labor and materials.
- S. The Contract Documents:  
The Contract Documents consist of the Contract, any addenda thereto, the completed Bid Form, the completed Bond and Insurance forms, the Notice Inviting Bids, the Instructions to Bidders, the General Conditions, the Supplementary General Conditions, the Labor Compliance Program, if any, the Technical Specifications, the Drawings and the Bidder's Questionnaire. All modification(s) amending or extending the work shall be as binding as if originally included in the Contract Documents. A Modification is a written amendment to the Contract signed by both parties, a Change Order, a Construction Change Directive, or a written order for a minor change in the Work issued by the Architect. The Contract Documents are complementary, and each obligation of the Contractor, Subcontractors, material or equipment suppliers in any one shall be binding as if specified in all.
- T. The Contract:  
The Contract Documents form the Contract for Construction. The Contract represents the entire and integrated agreement between the parties hereto and supersedes prior negotiations, representations, or agreements, either written or oral. The Contract may be amended or modified only by a written Modification. The Contract Documents shall not be construed to create a contractual relationship of any kind between the Architect and Contractor, between the Owner and any Subcontractor or Sub-subcontractor, or between any persons or entities other than the Owner and the Contractor. The Architect shall, however, be entitled to performance and enforcement of obligations under the Contract intended to facilitate performance of the Architect's duties.
- U. The Work:  
The Work shall include the initial obligation of any Contractor or Subcontractor, who performs any portion of the Work, to visit the Site of the proposed Work, a continuing obligation after the commencement of the Work to fully acquaint and familiarize itself with the conditions as they exist and the character of the operations to be carried on under the Contract Documents, and make such investigation as it may see fit so that it shall fully understand the facilities, physical conditions, and restrictions attending the Work under the Contract Documents. Each such Contractor or Subcontractor shall also thoroughly examine and become familiar with the Drawings, Specifications, and associated bid documents. The "Site" refers to the grounds of the Project as defined in the Contract Documents and such adjacent lands as may be directly affected by the performance of the Work.
- V. The Project:  
The Project is the total construction of the Work performed in accordance with the Contract Documents in whole or in part and which may include construction by the Owner or by separate Contractors.
- W. The Drawings:  
The Drawings are graphic and pictorial portions of the Contract Documents prepared for the Project and approved changes thereto, wherever located and whenever issued, showing the design, location, and scope of the Work, generally including plans, elevations, sections, details, schedules, and diagrams as drawn or approved by the Architect.

X. The Specifications:

The Specifications are that portion of the Contact Documents consisting of the written requirements for material, equipment, construction systems, instructions, quality assurance standards, workmanship, and performance of related services.

Y. The Project Manual:

The Project Manual is the volume usually assembled for the Work which may include, without limitation, the bidding requirements, sample forms, Conditions of the Contract, and Specifications.

#### 1.04 FORMAT AND SPECIFICATION EXPLANATIONS

A. Format Explanation: The format of principal portions of these specifications can be described as in the following paragraphs. Although some portions of these specifications may not be in complete compliance with this format, no particular significance will be attached to such compliance or non-compliance.

1. Sections and Divisions: For convenience, the basic unit of text is a "section." Each section is identified by a descriptive title (name) and the number. Individual sections are grouped together with other sections of similar or related work groupings known as "divisions." Divisions are recognized as the present industry consensus on uniform specification organization and sequence. The section title is not intended to limit meaning or content of a section, nor to be fully descriptive of the requirements specified therein, nor to be an integral part of the text.
  - a. Each section of specifications has been subdivided into 3 "parts" for uniformity and convenience (Part 1-General, Part 2-Products, and Part 3 - Execution); some sections may not require the use of all three parts. These parts do not limit the meaning of and are not an integral part of text which specifies requirements.

B. Subordination of Text: Portions of specification text are subordinated to other portions in the following manner (lowest level to highest):

1. Indented (from left margin) paragraphs and lines of text are subordinate to preceding text which is not indented, or which is indented by a lesser amount.
2. Paragraphs and lines of text are subordinate to sub-article titles, which are printed in upper/lower-case lettering.
3. Sub-articles are the subordinate to article titles, which are printed in uppercase lettering.
4. Subordination (if any) of certain sections (or portions of sections) to other sections is described within those sections.
5. Underscoring is used strictly to assist the reader of specification text in scanning text for key words (for quick recall). No emphasis on or relative importance of text is intended where underscoring is used.
6. Imperative language is used generally in specifications. Except as otherwise indicated, requirements expressed imperatively are to be performed by Contractor. For clarity of reading at certain locations, contrasting subjective language is used to describe responsibilities which must be fulfilled indirectly by Contractor, or when so noted, by others.
7. Section numbering is used to facilitate cross references in the contract documents. Sections are placed in Project Manual in numeric sequence; however, numbering sequence is not complete, and listing of sections at beginning of Project Manual must be consulted to determine numbers and names of specification sections in contract documents.

8. Page Numbering: Pages are numbered independently for each section and are recorded in the listing of sections (Index or Table of Contents) in Project Manual. The section number is shown together with the page number at the bottom of each page to facilitate the location of text in the Project Manual.
  9. Project Identification: Project name (either complete or abbreviated) is recorded at top of each page of specifications to minimize possible misuse of specifications, or confusion with other project specifications.
- C. Specification Content: Because of methods by which the project specification has been produced, certain general characteristics of content and conventions in use of language are explained as follows:
1. Specifying Methods: The techniques or methods of specifying to record requirements varies throughout text, and may include "prescriptive," "open generic-descriptive," "compliance with standards," "performance," "proprietary," or a combination of these. The method used for specifying one unit of work has no bearing on requirements for another unit of work.
  2. Overlapping and Conflicting Requirements: Where compliance with 2 or more industry standards or sets of requirements is specified, and overlapping of those different standards or requirements establishes different or conflicting minimums or levels of quality, the most stringent requirement is intended and will be enforced, unless specifically detailed language written into the contract documents clearly indicates that a less stringent requirement is to be fulfilled. Refer apparently-equal-but-different requirements, and uncertainties as to which level of quality is more stringent, to Architect/Engineer for a decision before proceeding.
  3. Contractor's Options: Except for overlapping or conflicting requirements, where more than one set of requirements are specified, for a particular unit of work, option is intended to be Contractor's regardless of whether or not it is specifically indicated as such.
- D. Minimum Quality/Quantity: In every instance, quality level or quantity shown or specified is intended to be the minimum for the work to be performed or provided. Except as otherwise specifically indicated, actual work may either comply exactly with that minimum (within specified tolerances), or may exceed that minimum within reasonable limits. In complying with these requirements, indicated numeric values are either minimums or maximums as noted or as appropriate for context of the requirements. Refer instances of uncertainty to Architect/Engineer for decision before proceeding.
- E. Specialists, Assignments: In certain instances, specification text requires (or implies) that specific work is to be assigned to specialists or expert entities, who must be engaged for the performance of that work. Such assignments shall be recognized as special requirements over which the Contractor has no choice or option. These requirements should not be interpreted so as to conflict with the enforcement of building codes and similar regulations governing the work; they are also not intended to interfere with local union jurisdiction settlements and similar conventions. Such assignments are intended to establish which party or entity involved in a specific unit of work is recognized as "expert" for indicated construction processes or operations. Nevertheless, the final responsibility for fulfillment of entire set of contract requirements remains with the Contractor.
- F. Trades: Except as otherwise indicated, the use of titles such as "carpentry" in specification text, implies neither that the work must be performed by an accredited or unionized tradesperson of corresponding generic name (such as "carpenter"), nor that specified requirements apply exclusively to work by tradespersons of that corresponding generic name.

- G. Abbreviations: The language of specifications and other contract documents is of the abbreviated type in certain instances, and implies words and meanings which will be appropriately interpreted. Actual word abbreviations of a self-explanatory nature have been included in the texts. Specific abbreviations have been established, principally for lengthy technical terminology and primarily in conjunction with coordination of specification requirements with notations on drawings and in schedules. These are frequently defined in section at first instance of use. Trade association names and titles of general standards are frequently abbreviated.
1. Singular words will be interpreted as plural and plural words will be interpreted as singular where applicable and where full context of the contract documents so indicates.

#### **1.05 DRAWING SYMBOLS**

- A. General: Except as otherwise indicated, graphic symbols used on drawings are those symbols recognized in the construction industry for purposes indicated. Where not otherwise noted, symbols are defined by "Architectural Graphic Standards," published by John Wiley & Sons, Inc., seventh edition.
- B. Mechanical/Electrical Drawings: Graphic symbols used on mechanical and electrical drawings are generally aligned with symbols recommended by ASHRAE. Where appropriate, these symbols are supplemented by more specific symbols as recommended by other recognized technical associations including ASME, ASPE, IEEE and similar organizations. Refer instances of uncertainty to the Architect/Engineer for clarification before proceeding.

#### **1.06 INDUSTRY STANDARDS**

- A. General Applicability of Standards: Except to the extent that more explicit or more stringent requirements are written directly into the contract documents, applicable standards of the construction industry have the same force and effect (and are made a part of contract documents by reference) as if copied directly into the contract documents, or as if published copies were bound herewith. Refer to other contract documents for resolution of overlapping and conflicting requirements which result from the application of several different industry standards to the same unit of work. Refer to individual unit of work sections for indications of which specialized codes and standard the Contractor must keep at the project site, available for reference.
1. Referenced standards (referenced directly in contract documents or by governing regulations) have precedence over non-referenced standards which are recognized in industry for applicability to work. See also Chapter 35 of the CBC.
  2. Non-referenced standards are hereby defined to have no particular applicability to the work, except as general requirements of whether the work complies with standards recognized in the construction industry.
- B. Publication Dates: Except as otherwise indicated, where compliance with an industry standard is required, comply with standard in effect as of date of contract documents.
1. Updated Standards: At the request of the Architect/Engineer, Contractor or governing authority, submit a change order proposal where an applicable industry code or standard has been revised and reissued after the date of the contract documents and before the performance of the work affected. The Architect/Engineer will decide whether to issue the change order to proceed with the updated standard.



- C. Copies of Standards: The contract documents require that each entity performing work be experienced in that part of the work being performed. Each entity is also required to be familiar with recognized industry standards applicable to that part of the work. Copies of applicable standards are not bound with the contract documents.
1. Where copies of standards are needed for proper performance of the work, the Contractor is required to obtain such copies directly from the publication source.
  2. Although certain copies of standards needed for enforcement of the requirements may be required submittals, the Architect/Engineer reserves the right to require the Contractor to submit additional copies of these standards as necessary for enforcement of the requirements.
- D. Abbreviations and Names: The following acronyms or abbreviations as referenced in contract documents are defined to mean the associated names. Both names and addresses are subject to change, and are believed to be, but are not assured to be, accurate and up-to-date as of date of contract documents:

AA	Aluminum Association 1525 Wilson Boulevard, Suite 600, Arlington, VA 22209 <a href="http://www.aluminum.org">www.aluminum.org</a>
AAMA	American Architectural Manufacturers Association 1827 Walden Office Square, Suite 550, Schaumburg, IL 60173-4268 <a href="http://www.aamanet.org">www.aamanet.org</a> ; 847.303.5664
AAN	American Association of Nurserymen 1200 G St. Suite 800; Washington, DC 20005 <a href="http://www.anla.org">www.anla.org</a> ; 202 789 2900
AASHTO	American Association of State Highway & Transportation Officials 444 N. Capitol St.; Washington, DC 20001 <a href="http://www.transportation.org">www.transportation.org</a> ; 202 624 5800
AATCC	American Association of Textile Chemists and Colorists P.O. Box 12215; Research Triangle Park, NC 27709-2215 <a href="http://www.aatcc.org">www.aatcc.org</a> ; 919 549 8141
ACA	American Coatings Association 1500 Rhode Island Ave., NW; Washington, DC 20005 <a href="http://www.paint.org">www.paint.org</a> ; 202-462-6272
ACI	American Concrete Institute 38800 Country Club Dr., Farmington Hills, MI 48331-3439 <a href="http://www.concrete.org">www.concrete.org</a> ; 313 532-2600
ACIL	American Council of Independent Laboratories 1725 K Street, NW; Washington, DC 20006 <a href="http://www.acil.org">www.acil.org</a> ; 202 887-5872
ACPA	American Concrete Pipe Association

8445 Freeport Parkway, Suite 350, Irving TX 75063-2595  
www.concrete-pipe.org 972 506 7216

- AF&PA American Forest & Paper Association  
1111 19<sup>th</sup> St. NW, Suite 800, Washington, CD 20036  
www.afandpa.org
- AGA American Gas Association  
400 N. Capitol St. NW, Washington DC 20001  
www.aga.org 202 824 7000
- AHAM Association of Home Appliance Manufacturers  
1111 19<sup>th</sup> St. NW, Suite 402, Washington, DC 20036  
www.aham.org 202 872 5955
- AI Asphalt Institute  
2696 Research Park Drive, Lexington, KY 40511-8480;  
www.asphaltinstitute.org 859 288 4960
- AIA American Institute of Architects  
1735 New York Ave. NW; Washington, DC 20006-5292  
www.aia.org 800 242 3837
- A.I.A. American Insurance Association  
2101 L Street NW, Suite 400, Washington DC 20037  
www.aiadc.org 202 828 7100
- AISC American Institute of Steel Construction  
One East Wacker Drive, Suite 700, Chicago, IL, 60601-18021  
www.aisc.org 312 670 2400
- AISI American Iron and Steel Institute  
25 Massachusetts Ave NW Suite 800, Washington, DC 20001  
www.steel.org 202 452 7100
- AITC American Institute of Timber Construction  
www.aitc-glulam.org 503 639 0651
- ALSC American Lumber Standard Committee, Inc.  
P.O. Box 210; Germantown, MD 20875-0210;  
www.alsc.org 301 972 1700
- ANSI American National Standards Institute  
25 West 43<sup>rd</sup> St. 4<sup>th</sup> Floor, New York, NY 10036  
www.ansi.org 212 642 4900
- APA American Plywood Association  
7011 South 19<sup>th</sup>, Tacoma, WA 98466;  
www.apawood.org 253 620 7400

ARI	Air Conditioning, Heating and Refrigeration Institute 2111 Wilson Blvd, Suite 500.; Arlington, VA 22201; www.ahrinet.org 703 524 8800
ASC	Adhesive and Sealant Council 7101 Wisconsin Ave, Ste 990, Bethesda, MD 20814; 301-986-9700 www.ascouncil.org
ASCE/SEI	American Society of Civil Engineers Structural Engineering Institute 1801 Alexander Bell Drive, Reston, VA 20191-4400 www.asce.org; 800 548 2723
ASHRAE	American Society of Heating, Refrigerating & Air Conditioning Engineers 1719 Tullie Circle, NE; Atlanta, GA 30329; www.ashrae.org ; 404 636 8400
ASME	American Society of Mechanical Engineers Three Park Ave, New York, NY 10016-5990 www.asme.org; 800-843-2763
ASPE	American Society of Plumbing Engineers 2980 S. River Road; Des Plaines, IL 60018 www.aspe.org; 847-296-0002
ASSE	American Society of Sanitary Engineers-CA Chapter 1111 W. James Wood Blvd.; Los Angeles, CA 90015 www.asse-plumbing.org; 213-688-9090
ASTM	American Society for Testing and Materials 100 Barr Harbor Dr / PO Box C700, West Conshohocken, PA 19428 www.astm.org; 215 299-5400
AWI	Architectural Woodwork Institute 46179 Westlake Drive;, Ste 120; Potomac Falls, VA 20165 571-323-3636
AWS	American Welding Society 8669 Doral Boulevard, Suite 130, Doral FL 33166 www.aws.org; 800 443 9353
AWPA	American Wood Protection Association P.O. Box 361784; Birmingham AL 35236-1784 www.awpa.com
AWWA	American Water Works Association 6666 W. Quincy Ave., Denver, CO 80235 303-794-7711
BHMA	Builders' Hardware Manufacturers Association

355 Lexington Ave 17<sup>th</sup> Floor, New York, NY 10017;  
www.buildershardware.com; 212-297-2122

BIFMA	Business and Institutional Furniture Manufacturer's Association 678 Front Ave NW, Ste. 150; Grand Rapids, MI 49504-5368; 616-285-3963
CBMA	Certified Ballast Manufacturers 2122 Keith Bldg.; Cleveland, OH 44115; 216 241-0711
CDA	Copper Development Association 260 Madison Ave; New York, NY 10016; 212-251-7200
CISPI	Cast Iron Soil Pipe Institute 1064 Dleaware Ave. SW, Atlanta, GA 30316 www.cispi.org; 404 622 0073
CPA	Composite Panel Association 19465 Deerfield Ave. Suite 306, Leesburg, VA 20176 www.compositepanel.org
CPSC	Consumer Product Safety Commission 4330 East West Highway; Bethesda, MD 20814-4408; 301-504-7923
CRI	Carpet and Rug Institute Box 2048/730 College Dr.; Dalton, GA 30720; 706-278-3176
CRSI	Concrete Reinforcing Steel Institute 933 Plum Grove Rd.; Schaumburg, IL 60173; 847-517-1200
CSA	Canadian Standards Association 5060 Spectrum Way, Mississauga, Ontario, Canada L4W 5N6
CSI	Construction Specifications Institute 110 South Union St., Ste. 100; Alexandria, VA 22314; 800-689-2900 www.csinet.org
CTI	Ceramic Tile Institute 310-574-7800
DHI	Door and Hardware Institute 14150 Newbrook Drive, Ste. 200; Chantilly, VA 20151-2232 www.dhi.org; 703-222-2010
DLPA	Decorative Laminate Products Association (Formerly National Association of Plastic Fabricators) Hulman Building; 20th Floor; 120 West Second Street; Dayton, OH 45402; 513/228-1041

DOC	US Dept. of Commerce, National Institute of Standards and Technology 1401 Constitution Avenue NW, Washington DC 20230
DOJ	US Department of Justice 950 Pennsylvania Ave. NW Civil Rights Division, Disability Rights Section-NYA Washington DC 20530
DOTn	Department of Transportation 1200 New Jersey Ave, SE; Washington, DC 20402-9325 202 426 4000
EIA	Electronic Industries Association 2001 Eye St., NW; Washington, DC 20006; 202 457-4900
EPA	Environmental Protection Agency 2001 Eye St., NW; Washington DC 20006; <a href="http://www.epa.gov">www.epa.gov</a> ; 202 457 4900
FEMA	Federal Emergency Management Agency, Federal Center Plaza 500 C St. S.W., Washington DC 20472 <a href="http://www.fema.gov">www.fema.gov</a>
FGMA	Flat Glass Marketing Association White Lakes Professional Bldg; 3310 Harrison; Topeka, KS 66611; 913 266-7013
FM	Factory Mutual Global Research, Standards Laboratory Dept.. 1301 Attwood Ave. POB 7500, Johnson, RI 02919; <a href="http://www.fmglobal.com">www.fmglobal.com</a>
GA	Gypsum Association 810 First St. N.E. #510, Washington, DC 20002-4268 <a href="http://www.gypsum.org">www.gypsum.org</a> ; 301 277 6886
HMMA	Hollow Metal Manufacturers Association See NAAMM below.
HPVA	Hardwood Plywood Veneer Association 1825 Michael Farraday Dr., Reston, VA 20190 <a href="http://www.hpva.org">www.hpva.org</a>
HUD	US Dept. of Housing and Urban Development 451 7 <sup>th</sup> St. SW, Washington, DC 20410
IBC	International Building Code 500 New Jersey Ave. NW 6 <sup>th</sup> Floor, Washington, DC 20001 <a href="http://www.iccsafe.org">www.iccsafe.org</a>

ICC	International Code Council 500 New Jersey Ave NW, 6 <sup>th</sup> Floor, Washington DC 20001 <a href="http://www.iccsafe.org">www.iccsafe.org</a>
IEEE	Institute of Electrical and Electronic Engineers, Inc. 3 Park Ave, 17 <sup>th</sup> Floor; New York, NY 10016 212-419-7900
IES	Illuminating Engineering Society 120 Wall St., Floor 17, New York, NY 10005-4001 212-248-5000
IRI	Industrial Risk Insurers 85 Woodland St.; Hartford, CT 06102; 203/525-2601
ISO	International Organization for Standardization ISO Central Secretariat 1 ch. De la Voie-Creuse, Case Postale 56 CH-1211 Geneva 20, Switzerland <a href="http://www.iso.org">www.iso.org</a>
MCAA	Mechanical Contractors Association of America 1385 Piccard Dr.; Rockville, MD 20850; 301-869-5800
MSS	Manufacturers Standardization Society of the Valve and Fittings Industry 127 Park St. NE; Vienna VA 22180-4602; 703-281-6613
NAAMM	National Association of Architectural Metal Mfrs. 800 Roosevelt Rd. Bldg C, Ste 312; Glen Ellyn, IL 60137 <a href="http://www.naamm.org">www.naamm.org</a> ; 630-942-6591
NBHA	National Builders Hardware Association (No Part of HDI) 711 Old Springhouse Rd.; McLean, VA 22101; 703 556-3990
NBS	National Bureau of Standards (U.S. Dept. of Commerce) Gaithersburg, MD 20234; 301 921-1000
NCMA	National Concrete Masonry Association 13750 Sunrise Valley, Herndon, VA 22071-4662
NECA	National Electrical Contractors Association 3 Bethesda Metro Center, Ste. 1100; Bethesda, MD 20814; 301 657 3110
NEII	National Elevator Industry, Inc. 1677 Country Route 64/PO Box 838; Salem, NY 12865-0838 518-854-3100
NEMA	National Electrical Manufacturers Association

1300 North 17<sup>th</sup> Street, Ste. 1752, Rosslyn, VA 22209; 703-841-3200

NFPA	National Fire Protection Association 1 Batterymarch Park, Quincy, MA 02169-7471 <a href="http://www.nfpa.org">www.nfpa.org</a> ; 617 770 3000
NHLA	National Hardwood Lumber Association P.O. Box 34518; Memphis, TN 38104; 901 377-1818 <a href="http://www.nhla.com">www.nhla.com</a>
NIST	National Institute of Standards and Technology (US Dept. of Commerce) 1401 Constitution Avenue NW, Washington DC 20230 <a href="http://www.nist.gov">www.nist.gov</a>
NRCA	National Roofing Contractors Association 10255 W. Higgins Rd., Ste. 600, Rosemont, IL 60018-5607 <a href="http://www.nrca.net">www.nrca.net</a> ; 847-299-9070
NSF	National Sanitation Foundation P.O. Box 130140/789 N. Dixboro Road, Ann Arbor, MI 48113-0140 <a href="http://www.nsf.org">www.nsf.org</a> 800-673-6275
OSHA	Occupational Safety & Health Administration (U.S. Dept. of Labor) 200 Constitution Ave; Washington, DC 20210 <a href="http://www.osha.gov">www.osha.gov</a> 800-321-6742
PCI	Precast Prestressed Concrete Institute 209 W. Jackson Blvd., Suite 500, Chicago, IL 60606-6938 <a href="http://www.pci.org">www.pci.org</a>
PDI	Plumbing and Drainage Institute 800 Turnpike Street, Ste. 300; North Andover, MA 01845 <a href="http://www.pdionline.org">www.pdionline.org</a> 978-557-0720
PTI	Post-Tensioning Institute 38800 Country Club Dr., Farmington Hills, MI 48331 <a href="http://www.post-tensioning.org">www.post-tensioning.org</a>
RFCI	Resilient Floor Covering Institute 115 Broad Street, Ste. 201; La Grange, GA 30240 <a href="http://www.rfci.com">www.rfci.com</a>
RIS	Redwood Inspection Service (Grading Rules) 818 Grayson Rd., Ste. 201; Pleasant Hill, CA 94523 <a href="http://www.redwoodinspection.com">www.redwoodinspection.com</a> 925-935-1499
SDI	Steel Deck Institute POB 25, Fox River Grove, IL 60021 <a href="http://www.sdi.org">www.sdi.org</a>
S.D.I.	Steel Door Institute

	30200 Detroit Rd.; Westlake, OH 44145 <a href="http://www.steeldoor.org">www.steeldoor.org</a> 440-899-0010
SFM	State of California, Dept. of Forestry and Fire Protection Office of the State Fire Marshal, POB 944246, Sacramento, CA 94246 <a href="http://osfm.fire.ca.gov">osfm.fire.ca.gov</a>
SGCC	Safety Glazing Certification Council 100 W. Main St. / PO Box 730; Sackets Harbor, NY 13685; 315-646-2234
SJI	Steel Joist Institute 1173B London Links Dr., Forest, VA 24551 <a href="http://steeljoist.org">steeljoist.org</a>
SMACNA	Sheet Metal & Air Conditioning Contractors' National Association 4201 Lafayette Center Drive;, Chantilly, VA 20151-1219 <a href="http://www.smacna.org">www.smacna.org</a> 703-803-2980
SPRI	Single-ply Roofing Institute 411 Waverly Oaks Rd., Suite 331B, Waltham, MA 02452 <a href="http://www.spri.org">www.spri.org</a>
SSPC	Steel Structure Painting Council (The Society for Protective Coatings) 40 24 <sup>th</sup> Street, 6 <sup>th</sup> Floor, Pittsburgh, PA, 15222-4656 <a href="http://www.sspc.org">www.sspc.org</a>
TCNA	Tile Council of North America 100 Clemson Research Blvd., Anderson, SC 29625, <a href="http://www.tcnatile.com">www.tcnatile.com</a> 864-646-8453
TIA	Telecommunications Industry Association 2500 Wilson Blvd., Ste 300; Arlington VA 22201 <a href="http://www.tiaonline.org">www.tiaonline.org</a> 703-907-7700
TMS	The Masonry Society 3970 Broadway, Unit 201-D, Boulder, CO 80304-1135 <a href="http://www.masonrysociety.org">www.masonrysociety.org</a>
TPI	Truss Plate Institute 218 N. Lee St., Suite 312, Alexandria, VA 22314 <a href="http://www.tpinst.org">www.tpinst.org</a>
UL	Underwriters Laboratories 333 Pfingsten Rd.; Northbrook, IL 60062-2096 <a href="http://www.ul.com">www.ul.com</a> 847 272 8800
ULC	Underwriters Laboratories of Canada 7 Underwriters Rd., Toronto, Ontario, Canada M1R3B4 <a href="http://www.ul.com/Canada/eng/pages/aboutus/">www.ul.com/Canada/eng/pages/aboutus/</a>



USC	United States Code, c/o Superintendent of Documents US Government Printing Office, Washington, DC 20402-9325
WCLIB	West Coast Lumber Inspection Bureau (Grading Rules) P.O. Box 23145; Portland, OR 97281 <a href="http://www.wclib.org">www.wclib.org</a> 503 639 0651
WDMA	Window and Door Manufacturers Association 1400 E. Touhy, #470, Des Plaines, IL 60018 <a href="http://www.wdma.com">www.wdma.com</a>
WI (WIC)	Woodwork Institute PO Box 980247; West Sacramento, CA 95798 <a href="http://www.wicnet.org">www.wicnet.org</a> 916-372-9943
WRI	Wire Reinforcement Institute 942 Main Street; Hartford, CT 06103 <a href="http://www.wirereinforcementinstitute.org">www.wirereinforcementinstitute.org</a>
WSC	Water Systems Council 1101 30 <sup>th</sup> Street Northwest; Washington, DC 20007-3708 <a href="http://www.watersystemscouncil.org">www.watersystemscouncil.org</a> 888 395 1033
WWPA	Western Wood Products Association (Grading Rules) 522 SW Fifth Ave., Ste. 500; Portland, OR 97204-2122 <a href="http://www.wwpa.org">www.wwpa.org</a> 503 224-3930
W.W.P.A	Woven Wire Products Association <a href="http://www.wovenwire.org">www.wovenwire.org</a>

### **1.07 GOVERNING REGULATIONS/AUTHORITIES**

- A. General: The procedure followed by Architect/Engineer has been to contact governing authorities where necessary to obtain information needed for the purpose of preparing contract documents; recognizing that such information may or may not be of significance in relation to Contractor's responsibilities for performing the work. Contact governing authorities directly for necessary information and decisions having a bearing on performance of the work.
- B. Trade Union Jurisdiction: It is a procedural requirement that the Contractor maintain and require prime subcontractors to maintain, complete current information on jurisdictional matters, regulations actions, and pending actions, as applicable to the work.
  - 1. Discuss new developments at appropriate project meetings at the earliest feasible dates.
  - 2. Record information of relevance along with the action agreed upon.
  - 3. The manner in which contract documents have been organized and subdivided is not intended to be an indication of jurisdictional or trade union agreements.
  - 4. Assign and subcontract the work, and employ tradesmen and laborers, in a manner which will not unduly risk jurisdictional disputes of a kind which could result in conflicts, delays, claims and losses in the performance of the work.

### **1.08 SUBMITTALS**

- A. Permits, Licenses and Certificates: For the Owner's records, submit copies of permits, licenses, certifications, inspection reports, releases, jurisdictional settlements, notices, receipts for fee payments, judgements, and similar documents, correspondence and records established in conjunction with compliance with standards and regulations bearing upon performance of the work.

### **PART 2 PRODUCTS**

Not Used

### **PART 3 EXECUTION**

Not Used

**END OF SECTION**

## SECTION 01 4523

### TESTING AND INSPECTION SERVICES

#### PART 1 GENERAL

##### 1.01 DESCRIPTION

- A. Work Included:
1. Selection and payment of Testing and Inspection Agency
  2. Testing and Inspection Agency submittals.
  3. Testing and Inspection Agency responsibilities.
  4. Testing and Inspection Agency reports.
  5. Limits on Testing and Inspection authority.
  6. Contractor's Responsibilities.
  7. Architect's Responsibilities.

##### 1.02 RELATED SECTIONS

- A. Related Sections:
1. Drawings and Contract Documents, including General and Supplemental General Conditions.
  2. Section 01 3300 - Submittals: Manufacturer's certificates.
  3. Section 01 3200- Construction Progress Schedule.
  4. Section 01 4000 - Quality Control.
  5. Section 09 0512 - Concrete Floor Moisture Content & pH Testing
  6. Section 01 7000 - Contract Closeout: Project Record Documents.
  7. Section 01 7500 - Starting of Systems.
  8. Technical Specifications - Pertinent Sections requiring tests and inspections.

##### 1.03 REFERENCES

- A. ASTM C802 - Practice for Conducting an Interlaboratory Test Program to Determine the Precision of Test Methods for Construction.
- B. ASTM C1021 - Practice for Laboratories Engaged in the Testing of Building Sealants.
- C. ASTM C1077 - Practice for Laboratories Testing Concrete and Concrete Aggregates for Use in Construction and Criteria for Laboratory Evaluation.
- D. ASTM C1093 - Practice for Accreditation of Testing Agencies for Unit Masonry.
- E. ASTM D290 - Recommended Practice for Bituminous Mixing Plant Inspection.
- F. ASTM D3740 - Practice for Evaluation of Agencies Engaged in Testing and/or Inspection of Soil and Rock as Used in Engineering Design and Construction.
- G. ASTM D4561 - Practice for Quality Control Systems for an Inspection and Testing Agency for Bituminous Paving Materials.

- H. ASTM E329 - Practice for Use in the Evaluation of Inspection and Testing Agencies as Used in Construction.
- I. ASTM E543 - Practice for Determining the Qualification of Nondestructive Testing Agencies.
- J. ASTM E548 - Practice for Preparation of Criteria for Use in the Evaluation of Testing Laboratories and Inspection Bodies.
- K. ASTM E699 - Practice for Criteria for Evaluation of Agencies Involved in Testing, Quality Assurance, and Evaluating Building Components in Accordance with Test Methods Promulgated by ASTM Committee E6.

#### **1.04 SELECTION AND PAYMENT**

- A. An independent testing laboratory approved by DSA shall perform inspections, tests, and other services as specified by various specification sections.
  - 1. Owner will employ and pay for testing laboratory to provide initial testing indicated under specific specification sections and specifically noted to be paid by the Owner.
  - 2. Contractor shall be back-charged for testing costs when:
    - a. Additional tests and inspections by Owner's testing agency where initial tests and inspections reveal failure to meet Contract requirements.
    - b. Excessive inspection time by Owner's testing agency is required by Contractor's failure to provide sufficient workman or to properly pursue the progress of work.
    - c. Test(s) deemed necessary by the Owner/ Architect to evaluate any substitution proposed by the Contractor.
    - d. Testing and inspection for the Contractor's convenience.
    - e. Testing and inspection overtime necessitated by the Contractor's schedule.
- B. Employment of inspection firm in no way relieves Contractor of obligation to perform Work in accordance with requirements of Contract Documents.
- C. Employment of any testing laboratory by Contractor shall be subject to Owner approval; laboratory shall be under direct supervision of a registered Engineer and shall conform to ASTM 329. Laboratory of concrete producer shall not be acceptable for concrete mix designs.
- D. Owner reserves the right to test any material or work of Project at any time, whether or not tests are indicated in Contract Documents.

#### **1.05 QUALITY ASSURANCE**

- A. Conform to requirements of the referenced standards.
- B. Laboratory: Authorized to operate in State in which Project is located.
- C. Laboratory Staff: Maintain a full-time registered Engineer on staff to review services.
- D. Testing Equipment: Calibrated at reasonable intervals with devices of an accuracy traceable to either National Bureau of Standards or accepted values of natural physical constants.

#### **1.06 CONTRACTOR SUBMITTALS**

- A. Prior to start of Work, submit testing laboratory OR inspection firm's name, address, and telephone number, and names of full-time registered Engineer and responsible officer.
- B. Each Contractor responsible for the construction of a main wind- or seismic-force resisting system, designated seismic or a wind- or seismic-resisting component list in the statement of special inspections shall submit a written statement of responsibility prior to commencement of work on the system or component. A copy of this written statement shall be maintained at the project site and made available upon request. The Contractor's statement of responsibility shall contain the following:
  - 1. Acknowledgment of awareness of the special requirements contained in the statement of special inspections;
  - 2. Acknowledgement that control will be exercised to obtain conformance with the construction documents approved by the building official;
  - 3. Procedures for exercising control within the Contractor's organization, the method and frequency of reporting and the distribution of the reports; and
  - 4. Identification and qualifications of the person(s) exercising such control and their position(s) in the organization.
- C. Submit copy of report of laboratory facilities inspection made by Materials Reference Laboratory of National Bureau of Standards during most recent inspection, with memorandum of remedies of any deficiencies reported by the inspection.

#### **1.07 AGENCY RESPONSIBILITIES**

- A. Test samples of mixes submitted by Contractor.
- B. Provide qualified personnel at site. Cooperate with Architect/Engineer and Contractor in performance of services.
- C. Perform specified sampling and testing of Products in accordance with specified standards.
- D. Ascertain compliance of materials and mixes with requirements of Contract Documents.
- E. Promptly notify Architect/Engineer and Contractor of observed irregularities or non-conformance of Work or Products.
- F. Perform additional tests required by Architect/Engineer.
- G. Attend preconstruction meetings and progress meetings.

#### **1.08 AGENCY AND INSPECTION REPORTS**

- A. After each test, observation or inspection, promptly submit copies of report to Architect, Engineer, DSA, Owner's Inspector, Owner, Contractor and as otherwise directed.
- B. Include:
  - 1. Date issued.
  - 2. Project title and number.
  - 3. Name of inspector.
  - 4. Date and time of sampling or inspection.
  - 5. Identification of product and specifications section.
  - 6. Location in the Project.

7. Type of inspection or test.
8. Date of test.
9. Results of tests.
10. Conformance with Contract Documents.

C. When requested by Architect/Engineer, provide interpretation of test or inspection results.

#### **1.09 LIMITS ON TESTING and INSPECTION AUTHORITY**

- A. Agency or laboratory may not release, revoke, alter, or enlarge on requirements of Contract Documents.
- B. Agency or laboratory may not approve or accept any portion of the Work.
- C. Agency or laboratory may not assume any duties of Contractor.
- D. Agency or laboratory has no authority to stop the Work.

#### **1.10 CONTRACTOR RESPONSIBILITIES**

- A. Provide information regarding activities requiring special inspection and tests to District's inspection and testing laboratory upon request.
- B. Provide agency or laboratory representative access to any chosen location and adequate samples of materials proposed to be used which require testing, along with proposed mix designs.
- C. Cooperate with laboratory personnel and provide access to the Work.
- D. Provide incidental labor and facilities:
  1. To provide access to Work to be tested.
  2. To obtain and handle samples at the site or at source of Products to be tested.
  3. To facilitate tests.
  4. To provide storage and curing of test samples.
- E. Notify agency or laboratory and Architect/Engineer forty-eight (48) hours prior to expected time for operations requiring testing services. Become familiar with time constraints of tests required. Schedule work to allow time for performance of required tests.
- F. Employ services of an independent qualified testing laboratory and pay for additional samples and tests required by Contractor beyond specified requirements.

#### **1.11 ARCHITECT RESPONSIBILITIES**

- A. Architect is not responsible for notification of the Testing Agency or scheduling its work.
- B. Architect will not be responsible for the actions of the Testing Agency.

#### **1.12 RE-TESTING**

- A. When initial tests indicate non-compliance with the Contract Documents, subsequent re-testing shall be performed by the same testing laboratory and the costs thereof shall be paid by the Owner and deducted from the Contract Sums owed to the Contractor.

**1.13 SCHEDULE OF INSPECTIONS**

- A. Division of State Architect Form SSS-103 SCHEDULE OF TESTS AND INSPECTIONS is attached.
- B. Individual Specification Sections: Other tests or inspections required; standards for testing.

**PART 2 PRODUCTS - NOT USED.**

**PART 3 EXECUTION - NOT USED.**

**END OF SECTION**

DIVISION OF STATE ARCHITECT FORM SSS-103 SCHEDULE OF TESTS AND INSPECTIONS FOLLOWS  
THIS SECTION

## SECTION 01 5000

### TEMPORARY FACILITIES

#### PART 1 GENERAL

##### 1.01 SCOPE

- A. Provide all required temporary facilities and controls as shown or specified herein and such additional facilities as required for proper performance of the work.
- B. All such temporary facilities shall be located where directed and maintained in a safe and sanitary condition at all times until completion of the contract and then removed from the site for safe disposal.

##### 1.02 TEMPORARY SANITARY FACILITIES

- A. Provide adequate temporary sanitary conveniences for the use of all employees and persons engaged on the work including subcontractors and their employees as required by law, ordinances or regulations of public authorities having jurisdiction.
- B. Toilet Facilities: Enclosed chemical toilets or water closets and urinals, types acceptable to the Architect, Owner and Authorities Having Jurisdiction.
  - 1. If fixtures are used, they shall not be incorporated into the building.
  - 2. Open pit or trench latrines will not be permitted.
- C. Permanent plumbing fixtures of the building shall not be used by construction personnel without the written consent of the Owner.
- D. Sanitary facilities locations shall be acceptable to the Architect and Owner and shall be maintained in a clean and sanitary condition during the entire course of the work. The Contractor shall keep such facilities adequately supplied with toilet paper, paper toweling, etc. as required.
- E. At completion of the work sanitary facilities shall be properly disinfected and all evidence of same removed from the site.

##### 1.03 TEMPORARY ELECTRIC FACILITIES

- A. Provide and maintain during the progress of the work all temporary electrical power and wiring requirements to facilitate the work of all trades and services connected with the work. All payment required by the utility company for the cost of their work in providing the service installation shall be paid for by the Contractor.
- B. The Owner will permit the operation or use of portions of the permanent electrical system to provide light and power during the construction period.
- C. The Contractor shall provide adequate temporary lighting for all work.

##### 1.04 TEMPORARY WATER



- A. The Contractor shall make arrangements for all water required for construction purposes. The Contractor shall furnish and install piping or hose to carry water to every point where needed on the project. All water used on the project shall be potable water.
- B. The Owner will permit the operation or use of portions of the permanent water system to provide water required for construction purposes during the construction period.
- C. Closest availability of water shall be determined by the Contractor.

#### **1.05 CONSTRUCTION EQUIPMENT**

- A. The Contractor shall erect, equip and maintain all construction equipment in strict accordance with all applicable statutes, laws, ordinances, rules and regulations of the Owner or other authority having jurisdiction. Provide as required for use of all trades. Hoists and scaffolding shall be installed and erected in accordance with the latest Construction Safety Orders issued by the Division of Industrial Safety, State of California and the Associated General Contractor's "Manual of Accident Prevention in Construction," latest edition.
- B. Scaffolding, staging, runways and similar equipment required for prosecution of the contract shall be provided and maintained by the Contractor.
- C. Hoists and construction elevators required for prosecution of the contract shall be provided and maintained by the Contractor complete with operators, power and signals as required.
- D. The Contractor shall provide, maintain and remove upon completion of the work all temporary rigging, scaffolding, hoisting equipment, rubbish chutes, barricades around openings and excavations, ladders between floors, fences and all other temporary work as required for all work hereunder.
- E. Temporary work shall conform to all the requirements of state, county and local authorities and underwriters which pertain to operation, safety and fire hazard. The Contractor shall furnish and install all items necessary for conformity with such requirements, whether or not called for under the separate divisions of these specifications.

#### **1.06 FENCES AND BARRICADES**

- A. Construct and maintain fences, planking, barricades, lights, shoring and warning signs as required by local authorities and state safety ordinances and as required to protect the Owner's property from injury or loss and as necessary for the protection of the public and provide walks around any obstructions made in a public place for carrying on the work covered in this contract. Leave all protection in place and maintain until removal is authorized.
- B. Security fencing shall be located such that clear and unobstructed access is maintained to all existing school facilities.
- C. Relocate fences and barricades as allowed by the progress of the work to minimize the area enclosed. Avoid unnecessary encroachment on existing facilities.

#### **1.07 PARKING AND EXTERIOR STORAGE**

- A. The Contractor shall make all arrangements and pay all costs for providing parking facilities for construction personnel, delivery vehicles and authorized visitors.
- B. Where space limitations will not permit adequate facilities within the Owner's property, arrangements for off-property facilities shall be made by the Contractor with city or county authorities or other parties having jurisdiction.
- C. The Contractor shall make similar arrangements for hardstands or other necessary provision for enclosed storage areas for materials, equipment and debris. Locations and perimeters of such facilities shall be subject to the approval of the Architect and authorities having jurisdiction.

#### **1.08 TEMPORARY FIELD OFFICES**

- A. Contractor Field Office: Contractor shall provide on the site a temporary field office with a minimum of two individual offices of suitable size for Contractor staff use and for consultations with representatives of the Architect and Owner. Field Office facility shall be:
  - 1. Weatherproof and secure,
  - 2. Provided with adequate lighting, heat, cooling and ventilation.
  - 3. Equipped with a plan rack and plan table, containing a complete set of Contract Documents at all times.
  - 4. Provide conference table and chairs to seat eight (8) persons with such additional furniture as the Contractor may require.
  - 5. Provide a temporary telephone, separate line for fax and internet connection with wireless service as hereinafter specified.
  - 6. Field office location shall be approved by the Architect prior to placing the building on the site.
  - 7. The Architect and Owner and their representatives shall have free access to the field office at all times.
  - 8. The field office shall remain the property of the Contractor and shall be removed from the site upon completion of the work.
  - 9. A suitable office trailer, meeting all foregoing requirements, may be provided for the job office at the Contractor's option.
- B. Inspector Field Office: The Contractor shall provide on the site a temporary job office with a minimum of two individual offices of suitable size for the Inspector of Record. Provide the following facilities:
  - 1. Weatherproof and secure;
  - 2. Provided with adequate lighting, heat, cooling and ventilation.
  - 3. Equipped with a plan rack and plan table and shall contain a complete set of Contract Documents at all times.
  - 4. Sturdy desk with file drawers and chair. The Inspector may provide additional furniture as he or she may require.
  - 5. Copy Machine as hereinafter specified.
  - 6. Provide temporary telephone lines, separate line(s) for fax and all handsets, fax terminal equipment and wireless internet connection with wireless service as hereinafter specified.
  - 7. Inspector's field office location shall be approved by the Architect and Inspector prior to placing the building on the site.
  - 8. The Architect and Owner and their representatives shall have free access to the Inspector's field office at all times. Contractor shall not have access to the Inspector's office.

9. The Inspector's field office shall remain the property of the Contractor and shall be removed from the site upon completion of the work. The Inspector will be responsible for removing his or her files and equipment.

C. Owner will not provide office space or furniture for the Contractor's use.

D. Contractor shall relocate field offices as progress of the work may require.

#### **1.09 TEMPORARY TELEPHONE, FAX, INTERNET CONNECTION AND OFFICE EQUIPMENT**

A. Provide temporary telephone, facsimile (fax) service and internet connection in the temporary field offices for use by the Contractor, Owner, Architect, Inspector and their representatives for purposes related to the work. The telephone, fax and internet connection shall be for the use of representatives mentioned above for local calls without charge to the caller.

B. Fax equipment shall be plain paper type.

C. Provide separate telephone lines, fax lines and internet connection as follows:

1. Contractor's Field Office: Two (2) Phone lines; One (1) fax line; one (1) internet connection.
2. Inspector's Field Office: Two (2) Phone lines; One (1) fax line; one (1) internet connection.

D. Inspector's Copy Machine: Provide copy machine service in the temporary Inspector's offices for use by the Owner, Architect, Inspector and their representatives for purposes related to the work. Contractor shall not use Inspector's copy machine.

E. Contractor's Copy Machine: Contractor's Option, provide copy machine service in the temporary Field offices for use by the Contractor.

F. Contractor's Responsibility for Costs: Make all arrangements and pay all costs, including service, maintenance and consumable supplies for the specified equipment, until final acceptance of the project.

#### **1.10 TEMPORARY HEATING, COOLING, VENTILATING**

A. Provide temporary heating, cooling, dehumidification and ventilation from an approved source whenever necessary for curing, drying, cooling or warming spaces as may be required for the installation of materials or finishes in specified conditions.

B. Maintain facilities or equipment as required for continuous operation of utilities in service. Do not allow interruption of utilities or services. Supply all fuel of types required.

C. Continue temporary services uninterrupted until permanent building systems are completed, capable of maintaining specified conditions without supplemental equipment, and accepted by the Owner.

#### **1.11 CONTINUITY OF SERVICES**

A. Provide temporary panels, raceway, conductors, piping, ductwork and other facilities or equipment as required for continuous operation of utilities in service. Do not allow interruption of utilities.

1. All utility services, such as water, gas, sewers, electricity, data, cable television, communication, clock, bell, or fire protection system serving the project, or any part of it, shall be maintained in continuous operation at all times for the duration of the contract.
2. Transfer of utilities function to new systems shall be coordinated in writing with the Owner at least two weeks in advance of the proposed date.
3. Notify and obtain approval from agencies having jurisdiction over utilities prior to transfer of function.
4. Coordinate provision and removal of temporary facilities with phasing of construction operations as indicated, or as necessary for continuity of service.

**1.12 REMOVAL AT COMPLETION**

- A. Upon completion of the work, or prior thereto when so directed by the Architect, the Contractor shall remove all temporary facilities, structures and installations from the Owner's property. Similarly, return all exterior areas utilized for temporary facilities to their original natural state or, when called for as part of the Work, complete areas as shown or noted.

**PART 2 PRODUCTS**

NOT USED

**PART 3 EXECUTION**

NOT USED

**END OF SECTION**

**SECTION 01 5600**

**TEMPORARY CONTROLS**

**PART 1 GENERAL**

**1.01 SECTION INCLUDES**

- A. Barriers, enclosures and fencing.
- B. Dust control.
- C. Water control.
- D. Weed control.
- E. Protection of Installed Work.
- F. Exterior Protection.
- G. Tree and Plant Protection.
- H. Resource Protection.
- G. Progress Cleaning.

**1.02 BARRIERS**

- A. Construct and maintain any necessary fences, barricades and warning signs as required by local authorities and state safety ordinances and as required to protect the Owner's property from injury or loss. Leave all protection in place and maintain until removal is authorized.
- B. Provide barriers to prevent unauthorized entry to construction areas, to allow for Owner's use of site, and to protect existing facilities and adjacent properties from damage from construction operations and demolition.

**1.03 DUST CONTROL**

- A. Control dust on the site. Maintain measures to prevent dust and debris from being transported outside the area of Work. Assume responsibility for damage caused by dust to the Work and for damage caused by dust outside the area of Work. Correct damages at Contractor's expense.
- B. Refer to Division 2 sections for additional requirements.

**1.04 WATER CONTROL**

- A. Grade site to drain. Provide, operate, and maintain pumping equipment as required to maintain excavations and site construction areas free of water.

- B. Protect site from puddling or running water. Provide water barriers as required to protect site from soil erosion.
- C. Do not permit water to stand in locked-in areas of buildings to receive concrete slabs-on-grade, nor on such slabs following their placement. Provide pumping or dewatering facilities and monitor during storm events to prevent these conditions.

#### **1.05 WEED CONTROL**

- A. Remove weeds from site that grow over the duration of the project.
- B. Prevent incorporation of organic materials into grading or topdressing.

#### **1.06 PROTECTION OF INSTALLED WORK**

- A. Protect installed Work throughout to maintain undamaged. Provide special protection where specified in individual specification sections.
- B. Provide temporary and removable protection for installed Products. Control activity in immediate work area to prevent damage.
- C. Prohibit traffic or storage upon waterproofed or roofed surfaces. If traffic or activity is necessary, obtain recommendations for protection from waterproofing or roofing material manufacturer.
- D. Prohibit traffic from landscaped areas.

#### **1.07 EXTERIOR PROTECTION**

- A. Provide temporary weather-tight enclosure of exterior walls for successive areas of building as necessary to:
  - 1. Allow for progress of work;
  - 2. Provide acceptable working conditions;
  - 3. Provide weather protection for materials;
  - 4. Permit effective heating, cooling, dehumidification or ventilation as circumstances may require;
  - 5. Prevent entry of unauthorized persons.
- B. Bear all costs for replacement of damage to existing or new construction, construction materials and equipment from effects of weather, theft and unauthorized entry.

#### **1.08 TREE AND PLANT PROTECTION**

- A. Preserve and protect existing trees and plants at site which are designated to remain, and those adjacent to site.
- B. Following consultation with Architect, remove roots and branches which interfere with indicated construction.
  - 1. Employ a qualified tree surgeon to prune and treat cuts.
- C. Provide temporary barriers to a height of six feet, around each, or around each group, of trees and plants.

- D. Protect root zones of trees and plants:
  - 1. Do not allow vehicular traffic and parking.
  - 2. Do not store materials or products.
  - 3. Prevent dumping of refuse or chemically injurious materials or liquids.
  - 4. Prevent puddling or continuous running water.
- E. Carefully supervise excavating, grading and filling, and subsequent construction operations, to prevent damage.
- F. Replace, or suitably repair, trees and plants designated to remain which are damaged or destroyed due to construction operations.

#### **1.09 PROGRESS CLEANING AND WASTE REMOVAL**

- A. Maintain areas free of waste materials, debris, and rubbish. Maintain site in a clean and orderly condition. Provide on-going, daily housekeeping and cleanup, including all debris boxes or method for disposal of debris. Contractor will not be permitted to leave debris, trash, leavings, dirt, garbage, rubbish, material containers, etc. on the site. No unsafe and un-workmanlike conditions will be permitted.
- B. Collect and remove waste materials, debris, and rubbish from site weekly and dispose off-site.

#### **1.10 REMOVAL OF CONTROLS**

- A. Remove temporary controls prior to inspection.
- B. Clean and repair damage caused by installation or use of temporary work.
- C. Restore existing facilities used during construction to original condition.

### **PART 2 PRODUCTS**

Not Used.

### **PART 3 EXECUTION**

Not Used.

END OF SECTION

## SECTION 01 6000

### PRODUCT REQUIREMENTS

#### PART 1 GENERAL

##### 1.01 SECTION INCLUDES

- A. General product requirements.
- B. Transportation, handling, storage and protection.
- C. Product option requirements.
- D. Substitution limitations and procedures.
- E. Procedures for Owner-supplied products.
- F. Spare parts and maintenance materials.

##### 1.02 RELATED SECTIONS

- A. Document 00 1013 - Notice Inviting Bids: Products designated by Owner as "District Standards."
- B. Document 00 2113 - Instructions to Bidders: Product options and substitution procedures prior to bid date.
- C. Document 00 7200 - General Conditions of the Contract: Product options and substitution procedures prior to bid date.
- D. Section 01 4000 - Quality Control: Product quality monitoring.

##### 1.03 DEFINITIONS

- A. Request For Substitution: Requests for changes in products, materials, or equipment required by Contract Documents proposed by the Contractor prior to and after award of the Contract are considered requests for substitutions. The following are not considered substitutions;
  - 1. Revisions to Contract Documents requested by the Owner or Architect.
  - 2. Specified options of products, materials, and equipment included in Contract Documents.

##### 1.04 SUBMITTALS

- A. Proposed Products List: Submit list of major products proposed for use, with name of manufacturer, trade name, and model number of each product.
  - 1. Submit within 15 days after date of Agreement.
  - 2. For products specified only by reference standards, list applicable reference standards.



- B. Product Data Submittals: Submit manufacturer's standard published data. Mark each copy to identify applicable products, models, options, and other data. Supplement manufacturers' standard data to provide information specific to this Project.
- C. Shop Drawing Submittals: Prepared specifically for this Project.
- D. Sample Submittals: Illustrate functional and aesthetic characteristics of the product, with integral parts and attachment devices. Coordinate sample submittals for interfacing work.
  - 1. For selection from standard finishes, submit samples of the full range of the manufacturer's colors, textures, and patterns.
- E. Indicate utility and electrical characteristics, utility connection requirements, and location of utility outlets for service for functional equipment and appliances

## **PART 2 PRODUCTS**

### **2.01 PRODUCTS**

- A. Do not use materials and equipment removed from existing premises, except as specifically permitted by the Contract Documents.
- B. Provide interchangeable components of the same manufacture for components being replaced.
- C. Products or equipment referenced with a manufacturer's name and/or model number shall be provided with all standard materials, components, compliance requirements and features normally furnished for that model or product. These items and requirements are inherent in the specification whether or not individually itemized.
- D. Manufacturer's Requirements: Any deviation from design requirements shown or specified, resulting either from Contractor's or supplier's change of model, or manufacturer's recommendation, or from submitted alternates or accepted substitutions, shall be clearly indicated on the Contractor's submittals. Contractor shall provide all such manufacturer or supplier supplemental requirements at no additional cost.
- E. Owner's Requirements:
  - 1. Pursuant to the requirements of California Public Contract Code 3400, the Owner may designate certain products as "District Standards" in order that a field test or experiment may be made to determine the product's suitability for future use, or in order to match other products in use on a particular public improvement, either completed or in the course of construction.
  - 2. A list of these designated products as may be applicable to the project is contained in the Notice Inviting Bids, as required by PCC 3400. These products shall be provided as specified and are not subject to substitution. All bids shall be deemed to include these listed items as specified without additional costs.
  - 3. In the event of a conflict between the Notice Inviting Bids and the technical specifications for a product's provision for substitutions, the Notice Inviting Bids shall govern.

### **2.02 PRODUCT OPTIONS**

- A. Products Specified by Reference Standards or by Description Only: Use any product meeting those standards or description.

- B. Products Specified by Naming a Single Manufacturer with a Provision for Substitutions: Submit a request for substitution in accordance with specified procedures for products meeting specifications from any manufacturer not named. For such specifications, the Architect is aware of only one manufacturer providing products meeting the specification, pursuant to PCC 3400.
- C. Products Specified by Naming Multiple Manufacturers with a Provision for Substitutions: Submit a request for substitution in accordance with specified procedures for products meeting specifications from any manufacturer not named.
- D. Products Specified by Naming A Single Manufacturer or Multiple Manufacturers without Provision for Substitution: Use only a product of one of the manufacturers named and meeting specifications. No options or substitutions allowed.
- E. Products Specified by Naming A Single Manufacturer or Multiple Manufacturers as listed in the Notice Inviting Bids: Use only a product of one of the manufacturers named and meeting specifications. No options or substitutions allowed.

### **2.03 SPARE PARTS AND MAINTENANCE PRODUCTS**

- A. Provide spare parts, maintenance, and extra products of types and in quantities specified in individual specification sections.
- B. Deliver to Project site, prior to final payment.
  - 1. Provide materials list for all items turned over to the Owner including quantities.
  - 2. Deliver items in presence of Owner designated representative to the location identified by the Owner.
  - 3. Obtain Owner designated representative sign-off of materials list attesting to receipt of items in triplicate. Retain one copy, provide one copy to Owner representative receiving items, and submit one copy to Architect.

## **PART 3 EXECUTION**

### **3.01 LIMITATIONS ON SUBSTITUTIONS SUBMITTED PRIOR TO THE RECEIPT OF BIDS**

- A. The Bid shall be based upon the standards of quality established by those items of equipment and/or materials which are indicated in the Contract Documents, including those products designated as "District Standards".
- B. Architect may consider requests for substitutions of specified equipment and/or materials only when requests are received by Architect within **twenty-one (21)** days prior to the date of bid, in conformance with Public Contract Code Section 3400. Do not request substitutions for products designated as "District Standards".
- C. Architect will consider a substitution request only if request is made in strict conformance with provisions of this Section. Request shall be fully responsive to all product requirements of the specified product, including those requirements noted in this section in the article titled PRODUCTS.

- D. Burden of proof of merit of requested substitution is the responsibility of the proposer requesting the substitution.
- E. It is the sole responsibility of the proposer requesting the substitution to establish proper content of submittal for requests for substitutions. Incomplete submittals will be rejected.
- F. When substitution is not accepted, provide specified product.
- G. Substitute products shall not be included within the bid without written acceptance by Addendum.

### **3.02 LIMITATIONS ON SUBSTITUTIONS SUBMITTED AFTER THE AWARD OF THE CONTRACT**

- A. The Contract is based upon the standards of quality established by those items of equipment and/or materials which are indicated in the Contract Documents, including those products designated as "District Standards".
- B. Architect will consider substitution requests received after the established date of the receipt of bids or contract award only when one or more of the following conditions are met and documented:
  - 1. Specified item fails to comply with regulatory requirement.
  - 2. Specified item is no longer manufactured.
  - 3. Specified item, through no fault of the Contractor, unavailable in the time frame required to meet project schedule.
  - 4. Specified item, through subsequent information disclosure, will not perform properly or fit in designated space.
  - 5. Manufacturer declares specified product to be unsuitable for use intended or refuses to warrant installation of product,
  - 6. Substitution would be, in the sole judgment of the Architect, a substantial benefit to the Owner in terms of cost, time, energy conservation, or other consideration of merit.
- C. Notwithstanding other provisions of this section and the above, the Architect may consider a request for substitution after the date of the receipt of bids or contract award, if in the sole discretion of the Architect, there appears to be just cause for such a request. The acceptance of such a late request does not waive any other specified requirement.
- D. Architect will consider a request for substitution after the date of the receipt of bids or contract award only if request is made in strict conformance with provisions of this section. Request shall be fully responsive to all product requirements of the specified product, including those requirements noted in this section in the article titled PRODUCTS.
- E. Substitutions will not be considered when they are indicated or implied on shop drawing or product data submittals, without separate written request, or when acceptance will require revision to the Contract Documents.
  - 1. Review of shop drawings does not constitute acceptance of substitutions indicated or implied on shop drawings.
  - 2. Substitutions will not be considered when requested or submitted directly by subcontractor or supplier.

- F. Contractor's failure or inability to pursue the work promptly or coordinate activities properly shall not establish a cause for consideration of Substitutions.
- G. Burden of proof of merit of requested substitution is the responsibility of the Contractor.
- H. It is the sole responsibility of the Contractor to establish proper content of submittal for requests for substitutions. Incomplete submittals will be rejected.
- I. When substitution is not accepted, provide specified product.
- J. Substitute products shall not be provided without written acceptance by Change Order.

### 3.03 SUBSTITUTION PROCEDURES

- A. Document each request on Architect's Request For Substitution (RFS) form with complete data substantiating compliance of proposed substitution with Contract Documents. All requests for substitution must be submitted on the specified form which may be obtained from the Architect. Requests received without the Request Form will be rejected.
- B. A request for substitution constitutes a representation that the proposer:
  - 1. Has investigated proposed product and determined that it meets or exceeds the quality level of the specified product.
  - 2. Will provide the same warranty or bonds for the substitution as for the specified product.
  - 3. Will coordinate installation of an accepted substitution and make changes to other Work which may be required for the Work to be complete with no additional cost to Owner.
  - 4. Waives all claims for additional costs or time extension which may subsequently become apparent.
  - 5. Will reimburse the Owner for services provided by Owner and Architect for review or redesign services associated with re-approval by authorities.
- C. Regulatory Requirements: Proposer requesting the substitution shall be responsible for obtaining all regulatory approvals required for proposed substitutions.
  - 1. All regulatory approval shall be obtained for proposed substitutions prior to submittal of substitution request to Architect, unless Architect participation is required by the regulating agency.
  - 2. All substitutions that affect structural safety, fire and life safety, access compliance or energy (as applicable) shall be submitted to Division of State Architect for review and approval.
  - 3. All costs incurred by the Owner in obtaining regulatory approvals for proposed substitutions, including the costs of the Architect and any authority having jurisdiction over the project shall be reimbursed to the Owner. Costs of these services shall be reimbursed regardless of final acceptance or rejection of substitution.
- D. Substitution Submittal Procedure:
  - 1. Submit one original signature copy of only the Request For Substitution Form included in this Project Manual for consideration. Forms provided by proposer or other agencies or organizations are not acceptable. Limit each request to one proposed substitution.
  - 2. Submit shop drawings, product data, and certified test results attesting to the proposed product equivalence, including:
    - a. Statement of cause for substitution request.
    - b. Identify product by specification section and article number.

- c. manufacturer's name, address, and phone number.
- d. List of fabricators, suppliers, and installers as appropriate.
- e. List of similar Projects where proposed products have been used, date of installation and names of Architect and Owner.
- f. Confirmation of regulatory approvals
- g. Product data, including drawings and product samples.
- h. Fabrication and installation procedures.
- i. Comparison of the qualities of the proposed substitution with that specified.
- j. Cost data comparing the proposed substitution with the product specified.
- k. Any required license fees or royalties.
- l. Availability of maintenance service and source of replacement materials.
- m. Coordination information, including a list of changes or modifications needed to other items of work that will be required to accommodate Proposed substitution.
- n. Statement on the Substitution's effect on the Construction Schedule.
- o. Written certification by the proposer that the Substitution is equal or better in every respect to that required by the contract Documents and that substitution will perform adequately in the application intended.
- p. Written certification that the proposer will pay for all permits, fees, and costs required to implement the substitution, and including waiver of all claims for additional costs or time extension which may subsequently become apparent, and reimbursement of Owner and Architect for review or redesign services associated with re-approval by authorities.

### **3.04 ARCHITECT'S REVIEW OF SUBSTITUTIONS**

- A. The Architect will accept or reject proposed substitutions within fourteen (14) days of receipt of request.
- B. If a decision on a substitution cannot be made within the time allocated, the product specified shall be used.
- C. No extension of bid period or contract time will be made for substitution review.
- D. Final acceptance of a substitution submitted prior to the date established for the receipt of bids will be in the form of a Bid Clarification or Addendum.
- E. Final acceptance of a substitution submitted after the award of the contract will be in the form of an Architect Supplemental Instruction and/or Construction Change Direction.
- F. Architect/Engineer shall be the judge of the acceptability of the proposed substitution. Architect's decision on substitution requests is final and does not require documentation or justification.
- G. Rejection Of Substitution Request: Any of the following reasons shall be cause for rejection, all as determined by the Architect;
  1. Vagueness or incompleteness of Substitution submittal,
  2. Insufficient data, failure to meet specified requirements, (including warranty).
  3. Qualification of the requirements of the Substitution Form, including modification of any of the requirements.

- H. The Architect/Engineer will notify Contractor in writing of decision to accept, accept as noted, or not accept the request for substitution.
- I. Substitute products shall not be ordered or installed without written acceptance.
- J. Owner shall receive full benefit of any cost reduction as a result of any request for substitution.
- K. Provide submittals for accepted substitutions in accordance with specified requirements of the respective section and provisions of Section 01 3300.
  - 1. An accepted substitution is not acceptable as a submittal under Section 01 3300. Provide separate submittals for each review.

### **3.05 OWNER-SUPPLIED PRODUCTS**

- A. See Section 01 1100- Summary for identification of Owner-supplied products.
- B. Owner's Responsibilities:
  - 1. Arrange and pay for product delivery to site.
  - 2. On delivery, inspect products jointly with Contractor.
  - 3. Submit claims for transportation damage and replace damaged, defective, or deficient items.
  - 4. Arrange for manufacturers' warranties, inspections, and service.
- C. Contractor's Responsibilities:
  - 1. Receive and unload products at site; inspect for completeness or damage jointly with Owner.
  - 2. Handle, store, install and finish products.
  - 3. Repair or replace items damaged after receipt.
  - 4. Coordinate installation with other trades.

### **3.06 TRANSPORTATION AND HANDLING**

- A. Transport and handle products in accordance with manufacturer's instructions.
- B. Promptly inspect shipments to ensure that products comply with requirements, quantities are correct, and products are undamaged.
- C. Provide equipment and personnel to handle products by methods to prevent soiling, disfigurement, or damage.

### **3.07 STORAGE AND PROTECTION**

- A. Store and protect products in accordance with manufacturers' instructions.
- B. Store with seals and labels intact and legible.
- C. Store sensitive products in weather tight, climate controlled, enclosures in an environment favorable to product.
- D. For exterior storage of fabricated products, place on sloped supports above ground.
- E. Cover products subject to deterioration with impervious sheet covering. Provide ventilation to prevent condensation and degradation of products.

- F. Store loose granular materials on solid flat surfaces in a well-drained area. Prevent mixing with foreign matter.
- G. Provide equipment and personnel to store products by methods to prevent soiling, disfigurement, or damage.
- H. Arrange storage of products to permit access for inspection. Periodically inspect to verify products are undamaged and are maintained in acceptable condition.
- I. Provide bonded off-site storage and protection only when site does not permit on-site storage or protection. Obtain Owner's permission prior to initiating such off-site storage.

**END OF SECTION**

(REQUEST FOR SUBSTITUTION FORM FOLLOWS)

# Request for Substitution

**{Projects.Name}**

Project Number: {Projects.Number}  
DSA Application: {LegalDocInfo.NotaryStateOf}  
DSA File: {LegalDocInfo.NotaryName}

Specification Title: \_\_\_\_\_ Product Description: \_\_\_\_\_  
Specification Section: \_\_\_\_\_ Article/Paragraph: \_\_\_\_\_

Architect will consider substitution requests received after the date established as deadline for substitution request only when one or more of the following conditions are met and documented; indicate one or more conditions which apply:

- Specified item fails to comply with regulatory requirement.
- Specified item is no longer manufactured.
- Specified item, through no fault of the Contractor, unavailable in the time frame required to meet project schedule.
- Specified item, through subsequent information disclosure, will not perform properly or fit in designated space.
- Manufacturer declares specified product to be unsuitable for use intended or refuses to warrant installation of product.
- Substitution would be a substantial benefit to the Owner in terms of cost, time, energy conservation, or other consideration of merit.

Explain benefit (required): \_\_\_\_\_

Proposed Product Name (include specific model number): \_\_\_\_\_

Manufacturer: \_\_\_\_\_ Phone: \_\_\_\_\_

Address: \_\_\_\_\_

Installer: \_\_\_\_\_

Address: \_\_\_\_\_ Phone: \_\_\_\_\_

History:  New product  2-5 years old  5-10 years old  More than 10 years old

Difference between proposed substitution and specified product: \_\_\_\_\_

Attached comparative table. Include point-by-point comparison of each article number. **REQUIRED**

**Similar Installation:**

Project: \_\_\_\_\_ Architect: \_\_\_\_\_

Address: \_\_\_\_\_ Owner: \_\_\_\_\_

\_\_\_\_\_ Date Installed: \_\_\_\_\_

Proposed substitution affects other parts of Work?  No  Yes; Explain: \_\_\_\_\_

Savings to Owner for accepting substitution: \_\_\_\_\_ (\$ \_\_\_\_\_).

Proposed substitution changes Contract Time?  No  Yes; [Add] or [Deduct] \_\_\_\_\_ days.



# Substitution Request

(Continued)

As outlined in Specification Section 01 6000, a request for substitution constitutes a representation that the proposer:

- Has investigated proposed product and determined that it meets or exceeds the quality level of the specified product.
- Will provide the same warranty or bonds for the substitution as for the specified product.
- Will coordinate installation of an accepted substitution and make changes to other Work which may be required for the Work to be complete with no additional cost to Owner.
- Waives all claims for additional costs or time extension which may subsequently become apparent.
- Will reimburse Owner for services provided by Owner and Architect associated with re-approval by authorities.

{Company.Name} Representative Printed Name: \_\_\_\_\_

{Company.Name} Representative Signature: \_\_\_\_\_

Date Submitted from {Company.Name} to Architect: \_\_\_\_\_

Supporting Data Attached:     Drawings     Product Data     Samples     Tests     Reports

Additional comments: \_\_\_\_\_

\_\_\_\_\_

\_\_\_\_\_

\_\_\_\_\_

Architect's review and action:

- Substitution approved - Make submittals in accordance with Specification Section 01 3300.
- Substitution approved as noted - Make submittals in accordance with Specification Section
- 01 3300. Substitution rejected - Use specified materials.
- Substitution Request received too late - Use specified materials.

Reviewed by: \_\_\_\_\_ Date: \_\_\_\_\_

## SECTION 01 6116

### VOLATILE ORGANIC COMPOUND (VOC) RESTRICTIONS

#### PART 1 GENERAL

##### 1.01 SUMMARY

- A. VOC restrictions for product categories listed below under "DEFINITIONS."
  - 1. California Code of Regulations, Title 24, Part 11 California Green Building Standards Code, "CAL-Green".
- B. All products of each category that are installed in the project must comply; applicable laws and ordinances do not allow for partial compliance.
- C. Listing of a product in these specifications shall not be construed as a solicitation or requirement to use any product or combination of products in violation of the requirements of South Coast Air Quality Management District Rule No.1168, as described in Rule 1168(g).
  - 1. If a listed product does not meet the requirements of this rule, request approval for use of an alternate product by the same or another manufacturer meeting the requirements of this rule.
  - 2. Do not use products which do not meet the requirements of this rule.

##### 1.02 RELATED REQUIREMENTS

- A. Divisions 01 through 33 contain related requirements specific to the work of each of these Sections. Requirements may or may not include reference to this section.
- B. Section 01 8113 "Sustainable Design Requirements".

##### 1.03 DEFINITIONS

- A. VOC-Restricted Products: All products of each of the following categories when installed or applied on-site:
  - 1. Adhesives, sealants, and sealer coatings, regardless of specification section or division.
  - 2. Paints and coatings.
  - 3. Carpet and resilient flooring.
  - 4. Composite wood products; plywood, particleboard, wood fiberboard.
- B. Adhesives: All gunnable, trowelable, liquid-applied, and aerosol adhesives, whether specified or not; including flooring adhesives, resilient base adhesives, and pipe jointing adhesives.
- C. Sealants: All gunnable, trowelable, and liquid-applied joint sealants and sealant primers, whether specified or not; including firestopping sealants and duct joint sealers.

##### 1.04 REFERENCE STANDARDS

- A. California Code of Regulations, Title 24, Part 11 California Green Building Standards Code, "CAL-Green".
- B. Low-Emitting Materials Product List; California Collaborative for High Performance Schools (CHPS); current edition at [www.chps.net](http://www.chps.net).
- C. CRI (GLCC) - Green Label Testing Program - Approved Product Categories for Carpet Cushion; Carpet and Rug Institute; Current Edition.

- D. CRI (GLP) - Green Label Plus Carpet Testing Program - Approved Products; Carpet and Rug Institute; Current Edition.
- E. GEI (SCH) - GREENGUARD "Children and Schools" Certified Products; GREENGUARD Environmental Institute; current listings at [www.greenguard.org](http://www.greenguard.org).
- F. GreenSeal GS-36 - Commercial Adhesives; Green Seal, Inc.
- G. SCAQMD 1168 - South Coast Air Quality Management District Rule No.1168; current edition; [www.aqmd.gov](http://www.aqmd.gov).
- H. SCS (CPD) - SCS Certified Products; Scientific Certification Systems; current listings at [www.scs-certified.com](http://www.scs-certified.com).

#### **1.05 SUBMITTALS**

- A. See Section 01 3300 - Submittals Procedures.
- B. Evidence of Compliance: Submit for each different product in each applicable category.
  - 1. Identify evidence submittals with the words "CAL-Green VOC Compliance Report".
- C. Product Data: For each VOC-restricted product used in the project, submit product data showing compliance, except when another type of evidence of compliance is required.
- D. Installer Certifications for Accessory Materials: Require each installer of any type of product, (not just the products for which VOC restrictions are specified) to certify that either 1) no adhesives, joint sealants, paints, coatings, or composite wood or agrifiber products have been used in the installation of his products, or 2) that such products used comply with these requirements.
  - 1. Use the form following this section for installer certifications.

#### **1.06 QUALITY ASSURANCE**

- A. A. Testing Agency Qualifications: Independent firm specializing in performing testing and inspections of the type specified in this section.

### **PART 2 PRODUCTS**

#### **2.01 MATERIALS**

- A. General: Provide only products having volatile organic compound (VOC) content not greater than required by South Coast Air Quality Management District Rule No.1168 and less where required by code.
  - 1. These products may be specified in multiple sections throughout these specifications.
- B. Adhesives, including carpet: Comply with Title 24, Part 11, Table 5.504.4.1.
  - 1. Evidence of Compliance: Acceptable types of evidence are:
    - a. Report of laboratory testing performed in accordance with requirements.
    - b. Published product data showing compliance with requirements.
    - c. Certification by manufacturer that product complies with requirements.
- C. Joint Sealants: Comply with Title 24, Part 11, Table 5.504.4.2.
  - 1. Evidence of Compliance: Acceptable types of evidence are:
    - a. Report of laboratory testing performed in accordance with requirements.
    - b. Published product data showing compliance with requirements.
    - c. Certification by manufacturer that product complies with requirements.

- D. Aerosol Adhesives: Comply with Title 24, Part 11, Table 5.504.4.1. and California Code of Regulations Title 17, Section 94507.
  - 1. Evidence of Compliance: Acceptable types of evidence are:
    - a. Current GreenSeal Certification.
    - b. Report of laboratory testing performed in accordance with GreenSeal GS-36 requirements.
    - c. Published product data showing compliance with requirements.
- E. Paints and Coatings: Comply with Title 24, Part 11, Table 5.504.4.3; California Air Resources Board, Architectural Coatings Suggested Control Measure, February 1, 2008.
  - 1. Determination of VOC Content: Testing and calculation in accordance with 40 CFR 59, Subpart D (EPA Method 24), exclusive of colorants added to a tint base and water added at project site; or other method acceptable to authorities having jurisdiction.
    - a. Evidence of Compliance: Acceptable types of evidence are:
      - 1) Report of laboratory testing performed in accordance with requirements.
      - 2) Published product data showing compliance with requirements.
      - 3) Certification by manufacturer that product complies with requirements.
    - b. Provide coatings that comply with the most stringent requirements specified in the following:
      - 1) 40 CFR 59, Subpart D--National Volatile Organic Compound Emission Standards for Architectural Coatings.
      - 2) South Coast Air Quality Management District Rule No.1168.
- F. Carpet: Comply with Title 24, Part 11, 5.504.4.4; meet testing and product requirements of one of the following:
  - 1. Carpet & Rug Institute "Green Label Plus".
  - 2. California Department of Public Health Standard Practice for testing of VOC's (Specification 01350).
  - 3. NSF/ANSI 140 at Gold Level.
  - 4. Scientific Certification Systems Sustainable Choice.
  - 5. All carpet cushion installed shall meet requirements of Carpet & Rug Institute "Green Label Program".
  - 6. All carpet cushion installed shall meet requirements of Title 24, Part 11, Table 5.504.4.1.
- G. Resilient Flooring Products: Comply with Title 24, Part 11, 5.504.4.6. Fifty percent of floor area receiving resilient flooring shall have flooring complying with VOC emission limits in CHPS 2009 criteria and listed on the Low Emitting Materials List or Product Registry or certified under the Resilient Floor Covering Institute (RFCI) FloorScore program.
  - 1. Provide documentation verifying that finish materials are certified to meet pollutant limits. Acceptable types of evidence are:
    - a. Published product data showing compliance with requirements.
    - b. Inclusion on one of the following lists:
      - 1) [www.chps.net/dev/drupal/node/381](http://www.chps.net/dev/drupal/node/381)
      - 2) [www.rfci.com/int\\_FS-ProdCert.htm](http://www.rfci.com/int_FS-ProdCert.htm)
      - 3) [www.greenguard.org/default.aspx?tabid=135](http://www.greenguard.org/default.aspx?tabid=135)
      - 4) Other method acceptable to enforcing agency.
- H. Composite Wood Products: Comply with Title 24, Part 11, Table 5.504.4.5 formaldehyde limits for hardwood plywood, particleboard, and medium density fiberboard composite wood products.
  - 1. Title 24, Part 11, Table 5.504.4.5 Composite Wood Products Maximum Formaldehyde Emissions in Parts per Million.

PRODUCT	CURRENT LIMIT (Effective July 1, 2012)
Hardwood Plywood veneer core	0.05
Hardwood Plywood composite core	0.05
Particleboard	0.09
Medium Density Fiberboard	0.11
Thin Medium Density Fiberboard	0.13

2. Evidence of Compliance: Acceptable types of evidence are:
  - a. Chain of custody certifications
  - b. Published product data showing compliance with requirements.
  - c. Certification by manufacturer that product complies with requirements.
  - d. Other method acceptable to enforcing agency.

### **PART 3 EXECUTION**

#### **3.01 FIELD QUALITY CONTROL**

- A. Owner reserves the right to reject non-compliant products, whether installed or not, and require their removal and replacement with compliant products at no extra cost to Owner.
- B. All additional costs to restore indoor air quality, including fines by authorities, due to installation of non-compliant products will be borne by Contractor.

#### **3.02 RESTRICTED COMPONENTS**

- A. Restricted Components:
  1. Paints and coatings shall not contain any of the following:
    - a. Acrolein.
    - b. Acrylonitrile.
    - c. Antimony.
    - d. Benzene.
    - e. Butyl benzyl phthalate.
    - f. Cadmium.
    - g. Di (2-ethylhexyl) phthalate.
    - h. Di-n-butyl phthalate.
    - i. Di-n-octyl phthalate.
    - j. 1,2-dichlorobenzene.
    - k. Diethyl phthalate.
    - l. Dimethyl phthalate.
    - m. Ethylbenzene.
    - n. Formaldehyde.
    - o. Hexavalent chromium.
    - p. Isophorone.
    - q. Lead.
    - r. Mercury.
    - s. Methyl ethyl ketone.
    - t. Methyl isobutyl ketone.

- u. Methylene chloride.
- v. Naphthalene.
- w. Toluene (methylbenzene).
- x. 1,1,1-trichloroethane.
- y. Vinyl chloride.

B. The following tables are taken from South Coast Air Quality Management District Rule No.1168 and are believed accurate at the time of publication. All products used shall comply with the limits of Rule No. 1168. In the event of discrepancy between these values and those of Rule No. 1168, those of Rule No. 1168 shall prevail.

C. **Table 5.504.4.1 ADHESIVE VOC LIMIT**

Architectural Applications	Current VOC Limit
Indoor Carpet Adhesives	50
Carpet Pad Adhesives	50
Outdoor Carpet Adhesives	150
Wood Flooring Adhesives	100
Rubber Floor Adhesives	60
Subfloor Adhesives	50
Ceramic Tile Adhesives	65
VCT and Asphalt Tile Adhesives	50
Dry Wall and Panel Adhesives	50
Cove Base Adhesives	50
Multipurpose Construction Adhesives	70
Structural Glazing Adhesives	100
Single Ply Roof Membrane Adhesives	250

D. Table 5.504.4.1 Continued

	VOC Limits and Effective Dates **	** The specified limits remain in effect unless revised limits are listed in subsequent columns.		
Specialty Applications	Current VOC Limit	1-1-05	7-1-05	1-1-07
PVC Welding	510			
CPVC Welding	490			
ABS Welding	400		325	
Plastic Cement Welding	350	250		
Adhesive Primer for Plastic	650		550	
Computer Diskette Manufacturing	350			

Contact Adhesive	80			
Special Purpose Contact Adhesive	250			
Tire Retread	100			
Adhesive Primer for Traffic Marking Tape	150			
Structural Wood Member Adhesive	140			
Sheet Applied Rubber Lining Operations	850			
Top and Trim Adhesive	540			250

E. Table 5.504.4.1 Continued

For adhesives, adhesive bonding primers, or any other primer not regulated by the above two tables and applied to the following substrates, the following limits shall apply	
Substrate Specific Applications	Current VOC Limit
Metal to Metal	30
Plastic Foams	50
Porous Material (Except Wood)	50
Wood	30
Fiberglass	80

F. Table 5.504.4.2 SEALANT VOC LIMIT

If an adhesive is used to bond dissimilar substrates together the adhesive with the highest VOC content shall be allowed.	
Sealant	Current VOC Limit
Architectural	250
Marine Deck	760
Nonmembrane Roof	300
Roadway	250
Single Ply Roof Membrane	450
Other	420

Sealant Primers	Current VOC Limit
-----------------	-------------------

Architectural Porous	250
Non-Porous	775
Modified Bituminous	500
Marine Deck	760
Other	750
For low-solid adhesives or sealants the VOC limit is expressed in grams per liter of material as determined in paragraph (b)(32); for all other adhesives and sealants, VOC limits are expressed as grams of VOC per liter of adhesive or sealant less water and less exempt compounds as determined in paragraph (b)(31).	

G. Paints and Coatings: Architectural Paints and Coatings shall comply with VOC limits in Table 1 of ARB Architectural Coatings Suggested Control Measure, California Code of Regulations, Title 24, Part 11 California Green Building Standards Code, "CAL-Green" Table 5.504.4.3. All products used in this category shall comply with these limits, unless more stringent local and regional rules apply.

H. **Table 5.504.4.3 VOC CONTENT LIMITS FOR ARCHITECTURAL COATINGS (See Notes 2 & 3 below)**

Grams of VOC per Liter of Coating, less water and less exempt compounds.	
<b>COATING CATEGORY</b>	<b>Current VOC Limit 1/1/2012</b>
Flat Coatings	50
Nonflat Coatings	100
Nonflat High Gloss Coatings	150
<b>Specialty Coatings</b>	
Aluminum Roof Coatings	400
Basement Specialty Coatings	400
Bituminous Roof Coatings	50
Bituminous Roof Primers	350
Bond Breakers	350
Concrete Curing Compounds	350
Concrete / Masonry Sealers	100
Driveway Sealers	50
Dry Fog Coatings	150
Faux Finishing Coatings	350
Fire Resistive Coatings	350
Floor Coatings	100
Form-Release Compounds	250
Graphic Arts Coatings (Sign Paints)	500
High-Temperature Coatings	420
Industrial Maintenance Coatings	250
Low Solids Coatings (See Note 1 above)	120
Magnesite Cement Coatings	450



Mastic Texture Coatings	100
Metallic Pigmented Coatings	500
Multicolor Coatings	250
Pretreatment Wash Primers	420
Primers, Sealers and Undercoaters	100
Reactive Penetrating Sealers	350
Recycled Coatings	250
Roof Coatings	50
Rust Preventative Coatings	250
Shellacs:	
Clear	730
Opaque	550
Specialty Primers, Sealers and Undercoaters	100
Stains	250

Stone Consolidants	450
Swimming Pool Coatings	340
Traffic Marking Coatings	100
Waterproofing Membranes	250
Wood Coatings	275
Wood Preservatives	350
Zinc Rich Primers	340

1. Note 1: Grams of VOC per liter of coating including water and including exempt compounds
2. Note 2: Not Applicable
3. Note 3: Values in this table are derived from those specified by the California Air Resources Board, Architectural Coatings Suggested Control Measure, February 1, 2008. More information is available from the Air Resources Board.

**END OF SECTION**

**SECTION 01 6116.01**

**ACCESSORY MATERIAL VOC CONTENT CERTIFICATION FORM**

**1.01 FORM**

- A. Identification:
  - 1. Project Name: \_\_\_\_\_
  - 2. Project No.: \_\_\_\_\_
  - 3. Architect: \_\_\_\_\_
- B. Use of This Form:
  - 1. Because installers are allowed and directed to choose accessory materials suitable for the applicable installation, there is a possibility that such accessory materials might contain VOC content in excess of that permitted, especially where such materials have not been explicitly specified.
  - 2. Contractor is required to obtain and submit this form from each installer of work on this project.
  - 3. For each product category listed, circle the correct words in brackets: either [HAS] or [HAS NOT].
  - 4. If any of these accessory materials has been used, attach to this form product data and MSDS sheet for each such product.
- C. VOC content restrictions are specified in Section 01 6116.

**2.01 PRODUCT CERTIFICATION**

- A. I certify that the installation work of my firm on this project:
  - 1. [HAS] [HAS NOT] required the use of any ADHESIVES.
  - 2. [HAS] [HAS NOT] required the use of any JOINT SEALANTS.
  - 3. [HAS] [HAS NOT] required the use of any PAINTS OR COATINGS.
  - 4. [HAS] [HAS NOT] required the use of any COMPOSITE WOOD or AGRIFIBER PRODUCTS.
- B. Product data and MSDS sheets are attached.

**3.01 CERTIFIED BY: (Installer/Manufacturer/Supplier Firm)**

- A. Firm Name: \_\_\_\_\_
- B. Print Name: \_\_\_\_\_
- C. Signature: \_\_\_\_\_
- D. Title: \_\_\_\_\_ (officer of company)
- E. Date: \_\_\_\_\_

**END OF SECTION**

**SECTION 01 7000**

**CONTRACT CLOSEOUT**

**PART 1 GENERAL**

**1.01 SECTION INCLUDES**

- A. Closeout procedures.
- B. Final cleaning.
- C. Adjusting.
- D. Project record documents.
- E. Operation and maintenance data.
- F. Spare parts and maintenance Products.
- G. Warranties and bonds.
- H. Maintenance service.

**1.02 RELATED SECTIONS**

- A. Section 01 5600 - Temporary Controls.
- B. Section 01 7500 - Starting of Systems
- C. Section 01 2900 - Applications for Payment

**1.03 CLOSEOUT PROCEDURES**

- A. Submit written certification including:
  - 1. The Work, or a designated portion thereof, is substantially complete in accordance with Contract Documents and ready for Architect/Engineer's review.
  - 2. A comprehensive list of work which is incomplete or in need of correction.
  - 3. Draft closeout submittals for the Work, or designated portions thereof.
- B. Within a reasonable time after receipt of this certification, the Architect will perform initial review. Incremental review will not be performed.
- C. If the Architect determines that the Work is not substantially complete:
  - 1. The Architect will promptly notify the Contractor and Owner in writing, setting forth reasons for the determination.
  - 2. The Contractor shall correct or complete deficiencies in the Work and send a second written certification as above.
  - 3. The Architect will perform a subsequent review as above.

- D. Coordinate corrective work under provisions of Section 01 3900 - Coordination and Meetings.
- B. Upon the Architect's determination that the Work is substantially complete, the Architect will provide to the Contractor a document co-signed by the Owner's Representative indicating remainder of work to be accomplished prior to completion of the project, or contract recognized portion thereof.

#### **1.04 FINAL INSPECTION**

- A. Submit written certification that:
  - 1. Contract Documents have been reviewed,
  - 2. Work has been inspected, and that
  - 3. Work, or a designated portion thereof, is complete in accordance with Contract Documents and
  - 4. Systems and equipment have been tested in the presence of the Owner.
  - 5. Work is ready for Architect review.
- B. Within a reasonable time after receipt of this certification, the Architect will perform a review to verify the status of the Work.
- C. If the Architect determines that the Work is not substantially complete, defective or otherwise in need of correction:
  - 1. The Architect will promptly notify the Contractor and Owner in writing, setting forth reasons for the determination and listing the deficient work.
  - 2. The Contractor shall immediately correct or complete deficiencies in the Work and send a second written certification that the Work is complete.
  - 3. The Architect will perform a subsequent review as above.
  - 4. Additional review time by the Architect due to incomplete corrections may be "backcharged" to the Contractor by the Owner.
- D. When the Architect determines that the Work is complete in accordance with the Contract Documents, the Architect will request the Contractor to make closeout submittals.

#### **1.05 CLOSEOUT SUBMITTALS**

- A. Submit under provisions of Section 01 3300 - Submittals.
- B. Submittals for review shall be subdivided according to design consultant review.
- C. Submittals required by governing or other authorities.
- D. Evidence of payment and release of liens under the provisions of Section 01 2900 - Applications for Payment.
- E. Certificates of insurance for products and completed operations.
- F. Record Drawings
- G. Warranties and Bonds.
- H. Operations and Maintenance information and manuals.

- I. Submit final Application for Payment identifying total adjusted Contract Price, previous payments, and sum remaining due. Adjustments include:
  1. Approved Change Orders.
  2. Unit price calculations.
  3. Allowances.
  4. Liquidated Damages.
  5. Deductions for reinspection.
  6. Deductions for deficient work uncorrected.
  7. Other adjustments.
  8. Approved payments.
  9. Contract Sum as adjusted.
  10. Amount remaining due.

#### **1.06 FINAL CLEANING**

- A. Execute final cleaning prior to Architect's initial review.
- B. Clean equipment and fixtures to a sanitary condition with cleaning materials appropriate to the surface and material being cleaned. Remove excess lubrication and other substances.
- C. All marks, stains, fingerprints, dust, dirt, splattered paint and blemishes resulting from the various operations shall be removed throughout the Project. Stair treads and risers shall be wet-mopped. Glass shall be left clean and polished both inside and outside. Clean and buff all metalwork. Plumbing fixtures and light fixtures shall be washed clean. Vacuum carpeted and soft surfaces. Exposed concrete, ceramic tile and resilient flooring shall be swept, mopped and waxed (where appropriate) in full compliance with specific requirements of finish manufacturer's specifications. Hardware and other unpainted metals shall be cleaned and all building papers and other temporary protections and labels shall be removed throughout the building, or portion of the building where Contractor was involved, all to the satisfaction of the Architect and District.
- D. Contractor shall replace filters and clean heating and ventilating equipment used for temporary heating, cooling and ventilation.
- E. Clean debris from roofs, gutters, downspouts, and drainage systems.
- F. Clean site; sweep paved areas, rake clean landscaped surfaces.
- G. Remove waste, surplus materials and rubbish from the site.

#### **1.07 PROJECT RECORD DOCUMENTS**

- A. Maintain on site one set of the following record documents; record actual revisions to the Work:
  1. Drawings.
  2. Specifications.
  3. Addenda.
  4. Change Orders and other modifications to the Contract.
  5. Reviewed Shop Drawings, Product Data, and Samples.
  6. Manufacturer's instruction for assembly, installation, and adjusting.
- B. Ensure entries are complete and accurate, enabling future reference by Owner.

- C. Store record documents separate from documents used for construction.
- D. Record information concurrent with construction progress.
- E. Specifications: Legibly mark and record at each Product section description of actual Products installed, including the following:
  - 1. Manufacturer's name and product model and number.
  - 2. Product substitutions or alternates utilized.
  - 3. Changes made by Addenda and modifications.
- F. Record Drawings and Shop Drawings: Legibly mark each item to record actual construction including:
  - 1. Measured depths of foundations in relation to finish floor datum.
  - 2. Measured horizontal and vertical locations of underground utilities and appurtenances, referenced to permanent surface improvements.
  - 3. Measured locations of internal utilities and appurtenances concealed in construction, referenced to visible and accessible features of the Work.
  - 4. Field changes of dimension and detail.
  - 5. Details not on original Contract drawings.
- G. Submit reproducible documents to Architect prior to final Application for Payment, including indexed PDF(s) of all required documents. Provide one PDF file each for:
  - 1. Complete Record Specifications
  - 2. Complete Record Drawings
  - 3. Complete Record Shop Drawings
- H. Receipt and acceptance of Record Documents by the Owner is a precondition for filing Notice of Completion.

#### **1.08 OPERATION AND MAINTENANCE DATA**

- A. Submit data on 8-1/2 x 11 inch (A4) text pages, bound in three-ring "slant D" binders with durable plastic covers.
- B. Prepare binder cover with printed title "OPERATION AND MAINTENANCE INSTRUCTIONS", title of project and subject matter of binder when multiple binders are required.
- C. Internally subdivide the binder contents with permanent page dividers, logically organized as described below; with tab titling clearly printed under reinforced laminated plastic tabs.
- D. Contents: Prepare a Table of Contents for each volume, with each Product or system description identified, typed on white paper, in three parts as follows:
  - 1. Part 1: Directory, listing names, addresses, and telephone numbers of Architect/Engineer, Contractor, Subcontractors, and major equipment suppliers.
  - 2. Part 2: Operation and maintenance instructions arranged by system and subdivided by specification section. For each category, identify names, addresses, and telephone numbers of Subcontractors and suppliers. Identify the following:
    - a. Significant design criteria.
    - b. List of equipment.
    - c. Parts list for each component.

- d. Operating instructions.
  - e. Maintenance instructions for equipment and systems.
  - f. Maintenance instructions for [special] finishes, including recommended cleaning methods and materials, and special precautions identifying detrimental agents.
  - g. Receipts for spare parts, maintenance products and keys, attested by the Owner.
3. Part 3: Project documents and certificates, including the following:
- a. Shop drawings and product data.
  - b. Air and water balance reports.
  - c. Certificates.
  - d. Originals of warranties and bonds
- E. Submit draft copy of completed volumes as an indexed PDF of all required documents. This copy will be reviewed and returned with Architect comments. Revise content of all document sets as required prior to final submission.
- F. Submit two sets of revised final volumes, within 10 days after final inspection, including indexed PDF(s) of all required documents.
- G. Receipt and acceptance of Operations and Maintenance Documents by the Owner is a precondition for filing Notice of Completion.

#### **1.09 WARRANTIES AND BONDS**

- A. Submit guarantees as specified in the General Conditions.
- B. Provide duplicate copies.
- C. Execute and assemble transferable warranty documents from Subcontractors, suppliers, and manufacturers.
- D. Provide Table of Contents and assemble in a three ring binder with durable plastic cover. Also provide indexed PDF of scan of all warranties and bonds.
- E. Submit prior to final Application for Payment.
- F. Substantial Completion addressing warranties will only be recognized in relation to the following portions of work:
  1. None
- G. In the case that any portion of the work is eligible for a warranty start period prior to Notice of Completion as designated by above article 1.09.F, Contractor shall conform to procedures defined by articles 1.03 through 1.09, applicable to portion of work. Upon the Architect's determination that the Work is substantially complete, the Architect will:
  1. Prepare the Certificate of Substantial Completion upon AIA Form G704 with the Contractor's list of items to be completed or corrected, as verified and amended by the Architect.
  2. Submit the completed Certificate of Substantial Completion to the Contractor and the Owner for written acceptance of their respective duties set forth therein.
- H. For items of Work delayed beyond date of Notice of completion or Substantial Completion where applicable, provide updated submittal within 10 days after acceptance, listing date of acceptance as start of warranty period.

**1.10 MAINTENANCE SERVICE**

- A. Furnish service and maintenance of components indicated in specification sections during the warranty period.
- B. Examine system components at a frequency consistent with reliable operation. Clean, adjust, and lubricate as required.
- C. Include systematic examination, adjustment, and lubrication of components. Repair or replace parts whenever required. Use parts produced by the manufacturer of the original component.
- D. Maintenance service shall not be assigned or transferred to any agent or Subcontractor without prior written consent of the Owner.

**PART 2 PRODUCTS**

Not Used.

**PART 3 EXECUTION**

Not Used.

**END OF SECTION**



## SECTION 01 7419

### CONSTRUCTION WASTE MANAGEMENT

#### PART 1 GENERAL

##### 1.01 RELATED DOCUMENTS:

- A. Drawings and general provisions of each prime Contract, including General and Supplementary Conditions and other Division 01 Specification Sections, apply to this Section.

##### 1.02 SUMMARY:

- A. Contractor shall implement procedures to divert 75% of construction waste. As many of the waste materials as economically feasible shall be reused, salvaged, or recycled. Waste disposal in landfills shall be minimized.
- B. The Contractor shall develop a Waste Management Plan as defined in this Section and submit for review by the Owner, Construction Manager, and Architect.

##### 1.03 DEFINITIONS

- A. Waste Materials: construction materials that are excess to the contract requirements and which can not be effectively used in the Work.
- B. Salvage Materials: waste materials or materials that exist on the site that can be reused, either on site or by another entity.
- C. Recyclable Waste: waste materials that exist on site or are generated during the construction process that can be recycled/remanufactured into another material.
- D. Categories of salvageable or recyclable waste include the following:
  - 1. Concrete, Masonry, and Other Inert Fill Material: concrete, brick, rock, broken up asphalt pavement, clay, and other inert (non-organic) materials.
  - 2. Metals: metal scrap including iron, steel, copper, brass, and aluminum; includes beverage containers, packaging materials (such as metal banding), fencing, reinforcing bar, wiring, plumbing, etc.
  - 3. Untreated Wood: unpainted, untreated dimensional lumber, wood edging, wood shipping pallets, etc. Does not include pressure treated or creosote treated wood.
  - 4. Engineered Wood Products: plywood, oriented strand board, "Masonite", particleboard, manufactured trusses and beams, and glue-laminated timbers.
  - 5. Gypsum Wallboard: excess drywall construction materials including cuttings, other scrap, and excess materials.
  - 6. Cardboard: clean, corrugated cardboard such as used for packaging, etc.
  - 7. Paper Goods:
  - 8. Office paper: includes any paper, such as manufacturer instruction, specification sheets, files, correspondence, packaging, stiffeners, etc.
  - 9. Newsprint: shredded or whole newspaper goods.

10. Plastic: beverage containers, packaging materials (such as polystyrene “peanuts” and expanded polystyrene), containers (other than those used for hazardous materials), vinyl products, etc.
  11. Glass: includes glass beverage containers, and recyclable glass building materials.
  12. Insulation: rigid foam, batt, and loose fill insulation materials.
  13. Carpet: face fiber, backing, padding, and carpet cushion scrap.
  14. Paints: unused portions of paints and coatings applied on-site.
  15. Fabric: uncontaminated fabric scraps.
  16. Rubber: uncontaminated rubber scraps, including but not limited to recycled-content rubber flooring, rubber edging, tires that are no longer serviceable, etc.
  17. Other: any additional materials identified on-site to be valued for salvage, reuse, or recycling by the Contractor, Owner, Construction Manager, or Architect.
- E. Non-Recyclable Waste: All waste materials that are not able to be recycled, due to contamination, lack of recycling facilities or salvage options, or high cost.
- F. Source Separated: Materials that are separated on-site by category.
- G. Co-Mingled: Several types of construction waste that are combined in a single container. Co-mingling of recycling waste must be approved by the identified recycling facility.
- H. Hazardous Waste: Any substance whose handling and/or disposal is regulated as hazardous waste by local, state, or federal authorities.

#### 1.04 QUALITY ASSURANCE

- A. Regulatory Requirements: Comply with all applicable federal, state, and local ordinance and regulation requirements for recycling and waste management.
- B. Disposal Sites, Recyclers, and Waste Materials Processors: Use only facilities properly permitted by state and local authorities.
- C. Preconstruction Waste Management Conference: Prior to beginning work at the site, schedule and conduct a conference to review the Construction Waste Management Plan and discuss procedures, schedules and specific requirements for waste materials recycling and disposal. Discuss coordination and interface between the Contractor and other construction activities. Identify and resolve problems with compliance with requirements. Record minutes of the meeting, identifying all conclusions reached and matters requiring further resolution.
1. Plan Revision: Make any revisions to the Construction Waste Management Plan agreed upon during the meeting and incorporate resolutions agreed to be made subsequent to the meeting. Submit the revised plan to the Contracting Officer's Representative for approval.
- D. Implementation:
1. Designate an on-site party responsible for instructing workers and implementing the Construction Waste Management Plan.
  2. Distribute copies of the Construction Waste Management Plan to the job site foreman and each subcontractor.
  3. Include waste management and recycling in worker orientation.

4. Provide on-site instruction on appropriate separation, handling, recycling, and salvaging methods to be used by all parties at the appropriate stages of the work at the site.
5. Prominently display Waste Management Plan and clearly mark all containers and areas on site dedicated to source separation.
6. Include waste management and recycling discussion in pre-fabrication meetings with subcontractors and fabricators.
7. Also include discussion of waste management and recycling in regular job meetings and job safety meetings conducted during the course of work at the site.

#### **1.05 STORAGE AND HANDLING**

- A. Salvage Materials: Provide protective handling and storage as required for all items identified for salvage and reuse by the Owner, Construction Manager, or Architect.
- B. Recyclable Waste: Remove all recyclable materials, as identified in the Waste Management Plan, from the work location to approved containers daily. Failure to remove waste materials will be considered cause for withholding payment and/or termination of Contract.
- C. Provide separate collection containers as required by recycling haulers and to prevent contamination of materials, including protection from rain as applicable.
- D. Replace loaded containers with empty ones as demand requires but not less than weekly.
- E. Handling: Deposit all indicated recyclable materials in the containers in a clean (no mud, adhesives, solvents, petroleum contamination), debris-free condition. Do not deposit contaminated materials into the containers until such time as such materials have been cleaned.
- F. If contamination chemically combines with the material so that it cannot be cleaned, do not deposit into the recycle containers.

#### **1.06 PROJECT/SITE CONDITIONS**

- A. Environmental Requirements: Transport recyclable waste materials from the Work Area to the recycle containers and carefully deposit in the containers in a manner to minimize noise and dust. Close container covers immediately after materials are deposited. Do not place recyclable waste materials on the ground adjacent to a container.
- B. Existing Conditions: Coordinate with "Instructions to Bidders" and "Supplementary Conditions".

#### **1.07 SUBMITTALS**

- A. Construction Waste Management Plan: Contractor must submit complete Construction Waste Management Plan for review within 30 days from the Notice to Proceed.

### **PART 2 PRODUCTS**

#### **2.01 CONSTRUCTION WASTE MANAGEMENT PLAN**

- A. Construction Waste Management Plan: Contractor shall develop a construction waste management plan indicating proposed methods for collection, segregation, and removal of all construction wastes and debris produced by the work of this Contract, including all costs

associated with this plan. Those waste materials produced during the course of this Contract that can be recycled cost-effectively, shall be. The Waste Management Plan shall include, at a minimum, the following:

1. Provide an analysis of jobsite waste to be generated, including types and quantities.
2. Provide strategies for salvage, reuse, or recycling for a minimum of all materials listed below. Include additional waste materials that are deemed cost-effective to salvage, reuse, or recycle. See "Definitions" above for material categories.
3. Provide documentation to justify decision not to recycle any items listed below.
4. Show compliance with applicable state and local ordinances and regulations.
5. Include a list of recycling facilities to which indicated recyclable materials will be distributed for disposal.
6. Identify materials that are not recyclable or otherwise conservable that must be disposed of in a landfill or other means acceptable under governing State and local regulations.
7. List permitted landfills and/or other disposal means to be employed.
8. Indicate any instances where compliance with requirements of this Section does not appear to be possible and request resolution from the Architect.

B. Waste Materials: The following materials shall be salvaged or recycled according to this specification. Strategies for salvage and recycling shall be identified in the Waste Management Plan as required above.

1. Salvage Materials: Identify materials existing on site that are candidates for salvage and reuse, either on this Project or through sale or donation to local organizations.
2. Recyclable Materials: The following materials, at a minimum, shall be salvaged or recycled. Applies to all such listed waste materials produced during the course of this Contract.
  - a. Concrete, Masonry, and Other Inert Fill Material
  - b. Metals
  - c. Untreated Wood
  - d. Gypsum Wallboard Scrap
  - e. Cardboard
  - f. Paper Goods
  - g. Beverage Containers
  - h. Plastic
  - i. Glass
  - j. Carpet

C. Delivery Receipts: Maintain copies of delivery receipts for waste materials salvaged and sent to permitted waste materials processors or recyclers that indicate the location and name of firm accepting recyclable waste materials, types of materials, net weights of each type, date of delivery and value of materials.

D. Maintain working copy of Construction Waste Management Plan at site for review by Owner, Construction Manager, Architect, and all Trades involved in Project.

### **PART 3 EXECUTION**

#### **3.01 WASTE MANAGEMENT**

- A. General: Implement waste management procedures in accordance with approved construction waste management plan. Maintain procedure throughout the life of this Contract.

- B. Source Separation: Separate, store, protect, and handle at the project site all identified recyclable and salvageable waste products to prevent contamination of materials and maximize recyclability and salvageability of materials.
- C. Collection: Arrange for timely pickups from the site or deliveries to approved recycling facilities of designated waste materials to keep construction site clear and prevent contamination of recyclable materials. Maintain records accessible to the Contracting Officer's Representative for verification of construction waste materials recycling.
- D. Delivery Receipts: Keep and maintain records of all deliveries to recycling facilities and all pickups of waste materials at the site by others as specified above.
- E. Salvage and Reuse: Identify salvage and reuse options for all materials that are deemed to be reusable, but will not be reused on this Project.
- F. Non-Recyclable Waste: Collect and segregate non-recyclable waste for delivery to a permitted landfill site.
- G. Hazardous Waste: Control and dispose of hazardous waste in accordance with local, state, and federal regulations.

**END OF SECTION**

## SECTION 01 7500

### STARTING OF SYSTEMS

#### PART 1 GENERAL

##### 1.01 SECTION INCLUDES

- A. Starting of Systems:
  - 1. New systems in this Contract.
  - 2. Existing systems relocated or disturbed by the Work of this Contract.
- B. Demonstration and instructions.
- C. Testing, adjusting, and balancing.

##### 1.02 RELATED SECTIONS

- A. Section 01 4000 - Quality Control: Manufacturers field reports.
- B. Section 01 7000 - Contract Closeout: System operation and maintenance data and extra materials.

##### 1.03 STARTING SYSTEMS

- A. Coordinate schedule for start-up of various equipment and systems.
- B. Notify Architect seven days prior to start-up of each item.
- C. Verify that each piece of equipment or system has been checked for proper lubrication, drive rotation, belt tension, control sequence, and for conditions which may cause damage.
- D. Verify tests, meter readings, and specified electrical characteristics agree with those required by the equipment or system manufacturer.
- E. Verify that wiring and support components for equipment are complete and tested.
- F. Execute start-up under supervision of applicable Contractors' personnel in accordance with manufacturers' instructions.
- G. Submit a written report in accordance with Section 01 3300 - Submittals that equipment or system has been properly installed and is functioning correctly.

##### 1.04 DEMONSTRATION AND INSTRUCTIONS

- A. Demonstrate operation and maintenance of Products to Owner's personnel two weeks prior to date of Substantial Completion, including existing telephone, intercom and fire alarm.

- B. Demonstrate Project equipment by a qualified manufacturers' representative who is knowledgeable about the Project.
- C. For equipment or systems requiring seasonal operation, perform demonstration for other season within four months.
- D. Utilize operation and maintenance manuals as basis for instruction. Review contents of manual with Owners' personnel in detail to explain all aspects of operation and maintenance.
- E. Demonstrate start-up, operation, control, adjustment, trouble-shooting, servicing, maintenance, and shutdown of each item of equipment at agreed time, at designated location.

**PART 2 PRODUCTS**

Not Used.

**PART 3 EXECUTION**

Not Used.

**END OF SECTION**

## SECTION 01 7513

### EXECUTION REQUIREMENTS

#### PART 1 GENERAL

##### 1.01 SECTION INCLUDES

- A. Execution and installation requirements.
- B. Products and installation for patching and extending work.
- C. Transition and adjustments.
- D. Repair of damaged surfaces, finishes, and cleaning.
- E. Existing Systems: Relocation and restoration of function, testing.

##### 1.02 RELATED SECTIONS

- A. Section 01 3300 - Submittals: Submittals procedures.
- B. Section 01 4000 - Quality Requirements: Testing and inspection procedures.
- C. Section 01 5000 - Temporary Facilities and Section 015600 - Temporary Controls: Exterior enclosures, temporary heating/cooling/ventilating facilities.
- D. Section 01 7000 - Closeout Submittals: Project record documents, operation and maintenance data, warranties and bonds.

##### 1.03 SUBMITTALS

- A. Survey work: Submit name, address, and telephone number of Surveyor before starting survey work.
  - 1. On request, submit documentation verifying accuracy of survey work.
  - 2. Submit a copy of site drawing signed by the Land Surveyor, that the elevations and locations of the work are in conformance with Contract Documents.
  - 3. Submit surveys and survey logs as for the project record.
- B. Cutting and Patching: Submit written request in advance of cutting or alteration which affects:
  - 1. Structural integrity of any element of Project.
  - 2. Integrity of weather exposed or moisture resistant element.
  - 3. Efficiency, maintenance, or safety of any operational element.
  - 4. Visual qualities of sight exposed elements.
  - 5. Work of Owner or separate Contractor.

##### 1.04 QUALIFICATIONS



- A. For survey work employ a land surveyor registered in California and acceptable to Architect. Submit evidence of Surveyor's Errors and Omissions insurance coverage in the form of an Insurance Certificate.

#### **1.05 PROJECT CONDITIONS**

- A. Grade site to drain. Maintain excavations free of water. Provide, operate, and maintain pumping equipment.
- B. Protect site from puddling or running water. Provide water barriers as required to protect site from soil erosion.
- C. Ventilate enclosed areas to assist cure of materials, to dissipate humidity, and to prevent accumulation of dust, fumes, vapors, or gases.
- D. Dust Control: Execute work by methods to minimize raising dust from construction operations. Provide positive means to prevent air-borne dust from dispersing into atmosphere.
- E. Erosion and Sediment Control: Plan and execute construction by methods to control surface drainage from cuts and fills, from borrow and waste disposal areas. Prevent erosion and sedimentation.
- F. Noise Control: Provide methods, means, and facilities to minimize noise from demolition, earthwork and noise produced by construction operations.
- G. Pest Control: Provide methods, means, and facilities to prevent pests and insects from damaging the work.
- H. Rodent Control: Provide methods, means, and facilities to prevent rodents from accessing or invading premises.
- I. Pollution Control: Provide methods, means, and facilities to prevent contamination of soil, water, and atmosphere from discharge of noxious, toxic substances, and pollutants produced by construction operations.

#### **1.06 COORDINATION**

- A. Coordinate work of alterations and renovations to expedite completion sequentially and to accommodate occupancy requirements.
- B. Coordinate scheduling, submittals, and work of the various sections of the Project Manual to ensure efficient and orderly sequence of installation of interdependent construction elements, with provisions for accommodating items installed later.
- C. Verify utility requirements and characteristics of operating equipment are compatible with building utilities. Coordinate work of various sections having interdependent responsibilities for installing, connecting to, and placing in service, such equipment.

- D. Coordinate space requirements, supports, and installation of mechanical and electrical work which are indicated diagrammatically on Drawings. Follow routing shown for pipes, ducts, and conduit, as closely as practicable; place runs parallel with lines of building. Utilize spaces efficiently to maximize accessibility for other installations, for maintenance, and for repairs.
- E. In finished areas except as otherwise indicated, conceal pipes, ducts, and wiring within the construction. Coordinate locations of fixtures and outlets with finish elements.
- F. Coordinate completion and clean-up of work of separate sections.
- G. After Owner occupancy of premises, coordinate access to site for correction of defective work and work not in accordance with Contract Documents, to minimize disruption of Owner's activities.

## **PART 2 PRODUCTS**

### **2.01 PATCHING MATERIALS**

- A. New Materials: As specified in product sections; match existing products and work for patching and extending work.
- B. Type and Quality of Existing Products: Determine by inspecting and testing products where necessary, referring to existing work as a standard.
- C. Product Substitution: For any proposed change in materials, submit request for substitution described in Section 01 6000.

### **2.02 FABRICATION**

- A. Machine-roll components or elements required to be curved or radiused. Do not field bend or "walk-down". Provide true curves minimizing joints, segmented fabrication not allowed.

## **PART 3 EXECUTION**

### **3.01 EXAMINATION**

- A. Verify that existing site conditions and substrate surfaces are acceptable for subsequent work. Beginning new work means acceptance of existing conditions.
- B. Verify that demolition is complete in alterations areas and areas are ready for installation of new work.
- C. Verify that existing substrate is capable of structural support or attachment of new work being applied or attached.
- D. Examine and verify specific conditions described in individual specification sections.

- E. Verify that utility services are available, of the correct characteristics, and in the correct locations.
- F. Prior to Cutting: Examine existing conditions prior to commencing work, including elements subject to damage or movement during cutting and patching. After uncovering existing work, assess conditions affecting performance of work. Beginning of cutting or patching means acceptance of existing conditions.

### **3.02 PREPARATION**

- A. Cut, move, or remove items as necessary for access to alterations and renovation work. Replace and restore at completion.
- B. Remove unsuitable material not marked for salvage, such as rotted wood, corroded metals, and deteriorated masonry and concrete. Replace materials as specified for finished work.
- C. Remove debris and abandoned items from area and from concealed spaces.
- D. Close openings in exterior surfaces to protect existing work and salvage items from weather and extremes of temperature and humidity. Insulate ducts and piping to prevent condensation in exposed areas.
- E. Prepare surfaces and remove surface finishes to provide for proper installation of new work and finishes.
- F. Clean substrate surfaces prior to applying next material or substance.
- G. Seal cracks or openings of substrate prior to applying next material or substance.
- H. Apply manufacturer required or recommended substrate primer, sealer, or conditioner prior to applying any new material or substance in contact or bond.

### **3.03 LAYING OUT THE WORK**

- A. Verify locations of survey control points prior to starting work.
- B. Promptly notify Architect of any discrepancies discovered.
- C. Contractor shall locate and protect survey control and reference points.
- D. Control datum for survey is that indicated on Drawings.
- E. Protect survey control points prior to starting site work; preserve permanent reference points during construction.
- F. Promptly report to Architect the loss or destruction of any reference point or relocation required because of changes in grades or other reasons.
- G. Replace dislocated survey control points based on original survey control. Make no changes without prior written notice to Architect.

- H. Utilize recognized engineering survey practices.
- I. Establish elevations, lines and levels. Locate and lay out by instrumentation and similar appropriate means:
  - 1. Site improvements including pavements; stakes for grading, fill and topsoil placement; utility locations, slopes, and invert elevations.
  - 2. Grid or axis for structures.
  - 3. Building foundation, column locations, ground floor elevations.
  - 4. All other work as indicated or necessary.
- J. Periodically verify layouts by same means.
- K. Maintain a complete and accurate log of control and survey work as it progresses.

### **3.04 GENERAL INSTALLATION REQUIREMENTS**

- A. Install Products as specified in individual sections.
- B. Make neat transitions. Patch work to match adjacent work in texture and appearance. Where new Work abuts or aligns with existing, perform a smooth and even transition.
- C. When existing finished surfaces are cut so that a smooth transition with new work is not possible, terminate existing surface along a straight line at a natural line of division and make recommendation to Architect.
- D. Grind or bush split-faced or textured masonry to achieve hairline fit to adjacent trim, flashings, inserts, escutcheons or other penetrating elements.
- E. Where removal of partitions or walls results in adjacent spaces becoming one, rework floors, walls, and ceilings to a smooth plane without breaks, steps, or bulkheads.
- F. Where a change of plane of 1/4 inch or more occurs in existing work, submit recommendation for providing a smooth transition for Architect review and request instructions.
- G. Trim existing doors as necessary to clear new floor finish. Refinish trim as required.
- H. Refinish visible existing surfaces to remain in renovated rooms and spaces, to specified condition for each material, with a neat transition to adjacent finishes.
- I. Re-cover and refinish work that exposes mechanical and electrical work exposed accidentally during the work.

### **3.05 CUTTING AND PATCHING**

- A. Execute cutting and patching including excavation and fill to complete the work, to uncover work to install improperly sequenced work, to remove and replace defective or non-conforming work, to remove samples of installed work for testing when requested, to provide openings in the work for penetration of mechanical and electrical work, to execute patching to complement adjacent work, and to fit Products together to integrate with other work.

- B. Execute work by methods to avoid damage to other work, and which will provide appropriate surfaces to receive patching and finishing. In existing work, minimize damage and restore to original condition.
- C. Employ original installer to perform cutting for weather exposed and moisture resistant elements, and sight exposed surfaces.
- D. Cut rigid materials using masonry saw or core drill. Pneumatic tools not allowed without prior approval.
- E. Restore work with new Products in accordance with requirements of Contract Documents.
- F. Fit work air tight to pipes, sleeves, ducts, conduit, and other penetrations through surfaces.
- G. At penetrations of fire rated walls, partitions, ceiling, or floor construction, completely seal voids with fire rated material in accordance with Section 07840, to full thickness of the penetrated element.
- H. Refinish surfaces to match adjacent finish. For continuous surfaces, refinish to nearest intersection or natural break. For an assembly, refinish entire unit.
- I. Patch or replace portions of existing surfaces which are damaged, lifted, discolored, or showing other imperfections. Repair substrate prior to patching finish. Finish patches to produce uniform finish and texture over entire area. When finish cannot be matched, refinish entire surface to nearest intersections.

### **3.06 PROGRESS CLEANING**

- A. Maintain areas free of waste materials, debris, and rubbish. Maintain site in a clean and orderly condition.
- B. Remove debris and rubbish from pipe chases, plenums, attics, crawl spaces, and other closed or remote spaces, prior to enclosing the space.
- C. Broom and vacuum clean interior areas prior to start of surface finishing, and continue cleaning to eliminate dust.
- D. Collect and remove waste materials, debris, and rubbish from site periodically and dispose off-site.

### **3.07 PROTECTION OF INSTALLED WORK**

- A. Protect installed work and provide special protection where specified in individual specification sections.
- B. Provide temporary and removable protection for installed Products. Control activity in immediate work area to prevent damage.
- C. Provide protective coverings at walls, projections, jambs, sills, and soffits of openings.

- D. Protect finished floors, stairs, and other surfaces from traffic, dirt, wear, damage, or movement of heavy objects, by protecting with durable sheet materials.
- E. Prohibit traffic or storage upon waterproofed or roofed surfaces. If traffic or activity is necessary, obtain recommendations for protection from waterproofing or roofing material manufacturer.
- F. Prohibit traffic from landscaped areas.

### **3.08 ADJUSTING**

- A. Adjust operating Products and equipment to ensure smooth and unhindered operation.
- B. Testing, adjusting, and balancing HVAC systems: See Division 23 and Sections 01 4000 and 01 7500.

### **3.09 EXISTING SYSTEMS**

- A. Examine and test existing building systems and utilities with components requiring relocation during performance of this work. Examples may include but are not limited to:
  - 1. Mechanical Systems
  - 2. Plumbing Systems
  - 3. Electrical Systems, line voltage, low voltage, signal alarm, or data.
  - 4. Fiber-optic data or communication cabling systems.
- B. Remove or relocate these components while work is performed.
  - 1. Fiber-optic data cabling systems are extremely fragile and subject to mechanical damage. Relocate these systems with great care. Do not disconnect or remove these systems, which must remain in place and in operation during the Work.
- C. Restore these components to the former location upon completion of the Work.
- D. Test systems under provisions of Section 01 7500 to confirm proper operation. Conduct tests in the presence of the Architect and Owner's Representative.
- E. Perform remedial work as necessary to establish proper operation. Assume responsibility for proper operation of systems following completion of Work.

**END OF SECTION**

## SECTION 01 8113

### SUSTAINABLE DESIGN REQUIREMENTS

#### PART 1 GENERAL

##### 1.01 SUMMARY

- A. Section includes general requirements and procedures for compliance with California Code of Regulations, Title 24, Part 11 California Green Building Standards Code, "CAL-Green".
  - 1. Chapter 5- Non-Residential Mandatory Measures.

##### 1.02 RELATED REQUIREMENTS

- A. Pertinent sections specifying erosion control.
- B. Section 01 6116 - Volatile Organic Compound (VOC) Restrictions.
- C. Section 01 7419 - Construction Waste Management and Disposal.
- D. Section 01 7000 - Contract Closeout .
- E. Pertinent sections specifying landscape irrigation.

##### 1.03 DEFINITIONS

- A. CAL-Green Definitions: Certain terms are defined by CAL-Green in Chapter 5 of the Code. Words and terms used in this section shall have the meanings shown therein.

##### 1.04 INFORMATIONAL SUBMITTALS

- A. General: Submit CAL-GREEN submittals required by code and in other Specification Sections.
- B. CAL-GREEN submittals are in addition to other submittals. If submitted item is identical to that submitted to comply with other requirements, submit duplicate copies as a separate submittal to verify compliance with indicated CAL-GREEN requirements.
- C. Acceptable verification submittals are specified in the related sections.

#### PART 2 PRODUCTS

##### 2.01 REQUIREMENTS - GENERAL

- A. Provide products and procedures necessary to confirm CAL-GREEN compliance required in this Section. Although other Sections may specify some CAL-GREEN requirements, the Contractor shall determine additional materials, techniques, means, methods and procedures necessary to comply with CAL-GREEN requirements.

##### 2.02 STORM WATER POLLUTION PREVENTION PLAN

- A. Section 5.106.1: Comply with requirements of this code section, local ordinances, General Conditions, Special Provisions, and related sections specifying erosion control.

##### 2.03 OUTDOOR WATER USE

- A. Section 5.304.3.1: Irrigation Controllers: Comply with requirements of this code section, local ordinances and Section 32 8000.

**2.04 CONSTRUCTION WASTE REDUCTION**

- A. Section 5.408 Construction Waste Management, Diversion and Recycling: Comply with requirements of this code section, local ordinances and Section 01 7419.

**2.05 BUILDING MAINTENANCE AND OPERATION**

- A. Section 5.410.2.3, 4. Commissioning and Functional Performance Testing: Participate in Commissioning and provide functional performance testing as required by these code sections and as specified in Section 01 7500.
- B. Section 5.410.2.5. Documentation and Training: Provide Operations Training as required by these code sections and as specified in Section 01 7500 and Systems Manual as specified in Section 01 7500.

**2.06 POLLUTANT CONTROL**

- A. Section 5.504.3 Indoor Air Quality: Comply with requirements of this code section, local ordinances.
  - 1. During storage, rough installation and until final start-up of HVAC equipment, securely cover all ducts and air distribution component openings with plastic, tape, sheet metal or other methods acceptable to enforcing agency to reduce dust or debris collected in the system.
- B. Section 5.504.4 Finish Material Pollutant Control: All Finish materials shall comply with requirements of this code section, local ordinances and Section 01 6116.

**PART 3 EXECUTION**

**3.01 GENERAL**

- A. Comply with Section 01 7419 - Construction Waste Management and Disposal.
- B. Comply with execution requirements of related sections and applicable local codes and ordinances.

**END OF SECTION**



SECTION 01 8122

**ACOUSTICAL PERFORMANCE REQUIREMENTS**

**PART 1 GENERAL**

**1.01 SUMMARY**

- A. This section is the primary source of acoustical performance requirements for the Student Services Building the project documents. Should conflicts arise between the requirements in this section and other portions of the contract documents, the requirements in these sections shall take precedence, unless otherwise directed by the Architect. Under no circumstances, however, shall the requirements in this section take precedence over code or life safety requirements.
- B. Related Section: Section 01 81 23 Noise and Vibration Control.

**1.02 REQUIREMENTS**

- A. Noise levels generated by building systems in all occupied spaces shall be appropriately quiet. Refer to Section 01 81 23 for specific requirements.
- B. Upgraded sound isolation is required around all occupied spaces, including extra-heavy construction and airtight detailing. Refer to architectural wall, window, door, and ceiling requirements in the project drawings and specifications and subsequent paragraphs in this Section for further requirements.
- C. Noisy building service spaces (mechanical equipment, electrical equipment, toilet rooms) have been designed and shall be built to provide upgraded sound isolation to surrounding, occupied spaces.
- D. All construction surrounding all six sides of all occupied spaces and noisy building service spaces shall be constructed airtight, as described in this section and in the project drawings.

**PART 2 ACOUSTICAL PRODUCTS AND DETAILING**

**2.01 ACOUSTICAL PRODUCTS**

Refer to specific requirements in this section and in the Project Documents for:

- A. Sound Absorbing Ceiling Tiles: Minimum NRC of 0.70 and minimum CAC of 35.
- B. Linear Wood Ceilings: Minimum NRC of 0.80. Fiberglass infill required.
- C. Direct-Applied Acoustic Panels in Caferia Building: Minimum NRC of 0.70.
- D. Carpet, as scheduled.

## 2.03 AIRTIGHT CONSTRUCTION DETAILING

- A. All occupied spaces and noisy building service spaces shall be constructed "airtight" for the purposes of sound isolation and noise control. The requirements for such airtight construction include, but are not limited to, the requirements described herein and the details shown in the project drawings. All necessary products and detailing shall be provided to achieve airtight / leakproof construction, whether or not those products or details are specifically described or shown in the Project Documents.
- B. Every precaution shall be taken to maintain construction completely airtight on all six sides of all occupied spaces and noisy building service spaces. Construction joints, structural penetrations, mechanical and electrical duct penetrations, pipe and conduit penetrations, electrical boxes and fixtures, cabinets, doors, access panels, windows, frames, supports, etc. all shall be built and installed in such manner as to prevent sound transmission. Provide lintels, extra frames, blocking, escutcheons, grouting, gaskets, packing, caulking, dense putties, taping, filling, etc. as required to stop sound transmission.
- C. Applicable standards include ASTM E497 (Standard Practice for Installing Sound-Isolating Lightweight Partitions) and ASTM C919 (Practice for Use of Sealants in Acoustical Applications). In general:
1. Extend construction to a minimum of 1/8" and a maximum of 1/2" of adjacent construction or penetrations to provide a suitable space for packing and caulking.
  2. Cut openings in construction accurately for electrical boxes, piping, ductwork and other penetrating elements. Leave enough space around such elements so they remain free of rigid connection with the surrounding construction.
  3. Prior to packing and caulking penetrations as detailed herein, verify that all penetrating elements such as piping and ductwork are free and clear of the opening to be packed and caulked.
  4. Where multiple layers of gypsum board are used, stagger all joints in adjacent layers a minimum of 24".
  5. Apply all sealants and caulks in accordance with the manufacturer's instructions.
- D. Representative details for airtight penetrations, recessed elements, edges, etc. are shown in the project drawings. Some of these are also described below:
1. Partition Bases and Heads: Provide 1/4" (high) continuous bead of acoustical sealant at all locations where gypsum board meets structural flooring, roofing, or upper floor structure. The depth of the sealant shall equal the thickness of the gypsum layer or layers.
  2. Partition or Ceiling Joints at Dissimilar Materials: Provide 1/4" continuous bead of acoustical sealant at all locations where gypsum board meets dissimilar material. The depth of the sealant shall equal the thickness of gyp board layers.

3. Gypsum to Gypsum Joints (Vert. or Horiz.): Provide standard corner taping .
  4. Pipe, Duct, Conduit, or Structural Penetrations: Provide 1/4" wide bead of acoustical sealant around perimeter of small penetrating elements with controlled openings. Provide details in the project drawings for other conditions. The depth of the sealant shall equal the thickness of the gypsum layer or layers.
  5. Electrical Boxes 4"x 4" or Under: Provide 1/4" wide bead of acoustical sealant around perimeters of electrical boxes. The depth of the sealant shall equal the thickness of the gypsum layer or layers. Provide sheet caulking continuously around the back side of boxes.
  6. Electrical Boxes or Recessed Boxes Over 4"x 4": Provide one layer of 5/8" gypsum board continuous around the back of such boxes. Caulk or tape all joints and caulk all conduit penetrations with acoustical sealant.
- E. The Contractor shall be alert for additional conditions that may require special details or materials in order to achieve airtightness and shall bring these to the attention of the Architect.

### **PART 3 COMMISSIONING FOR ACOUSTICAL PERFORMANCE**

#### **3.01 REQUIREMENTS**

- A. Acoustical commissioning shall be arranged and paid for by the Contractor after construction. Acoustical commissioning shall be performed and coordinated by a qualified Acoustical Consultant or NEBB Certified Sound and Vibration Firm. The qualified Acoustical Consultant shall be a "full member" of INCE, a member of the NCAC, or employed by a member firm of the NCAC.
- B. Verifying Reverberation Times: If there is any question as to whether sound-absorbing materials have been installed as specified or designed, testing shall be done to verify reverberation times in teaching spaces. Testing and reporting shall be as required in the latest edition of ANSI/ASA Standard S12.60.
- C. Measuring Background Noise from Outdoor Sources: Testing and reporting shall be as required in the latest edition of ANSI/ASA Standard S12.60.
- D. Measuring Background Noise and Vibration from Building Systems: Refer to Section 01 81 23 Noise and Vibration Control.

**END OF SECTION 01 81 22**

Section 01 8123

**NOISE AND VIBRATION CONTROL**

**PART 1 GENERAL**

**1.01 SUMMARY**

- A. This section the acoustical performance requirement section in Division 1 are the primary source of requirements for noise and vibration control in the project documents. Should conflicts arise between the requirements in these sections and other portions of the contract documents, the requirements in these sections shall take precedence unless otherwise directed by the Architect. Under no circumstances, however, shall the requirements in these sections take precedence over code or life safety requirements.
- B. Objectionable noise and vibration caused by building systems shall be reduced to levels as close as possible to the maximum allowable noise and vibration criteria required in this section. All necessary adjustments and retesting of equipment and systems to achieve the criteria shall be provided at no cost to the Owner.
- C. Related Section: Section 01 81 22 Acoustical Performance Requirements.

**1.02 MAXIMUM ALLOWABLE NOISE CRITERIA FOR PROJECT SPACES**

- A. Maximum allowable background noise levels (NC and dBA) in project spaces due to operation of HVAC, plumbing or electrical equipment are listed below.

<u>Spaces</u>	<u>Maximum Background Noise Level</u>
Conference Rooms, Principals Office	NC-30
General Private Offices, Staff Lounge, Nurse, Staff Workrooms, Dining	NC-35
Open Offices, Reception, Hallways, Mail and File Rooms	NC-40
Toilet Rooms, Servery	NC-45
Kitchen	NC-50

- B. Should the noise levels in any room exceed the above criteria, the Contractor shall be responsible for rebalancing, adjusting, or retesting required to meet the criteria, at no additional cost to the Owner.

**1.03 MAXIMUM ALLOWABLE VIBRATION CRITERIA FOR ROTATING EQUIPMENT**

- A. Rotating devices shall be balanced according to the schedule below. The following vibration displacement levels shall not be exceeded when the equipment is rigidly grounded to structure (with the isolators blocked or "grounded out.")

Fans < 600 RPM:	4 mils peak to peak, maximum.
Fans 600 to 999 RPM:	3 mils peak to peak, maximum.
Fans 1000 to 2000 RPM:	2 mils peak to peak, maximum.
Fans > 2000 RPM:	1 mil peak to peak, maximum.
Pumps at 1800 RPM:	2 mils peak to peak, maximum.
Pumps at 3600 RPM:	1 mil peak to peak, maximum.

- B. Should any rotating equipment cause vibration exceeding the above criteria (or manufacturer's specifications), the Contractor shall be responsible for rebalancing, realignment, adjusting, or retesting required to meet the criteria, at no additional cost to the Owner.

#### **1.04 SOUND POWER LIMITS FOR HVAC EQUIPMENT**

- A. Maximum allowable sound power levels for all HVAC equipment shall not exceed the values for the equipment listed in the project documents and/or used as the basis of design for this project.
- B. Submit a tabulation of proposed products and noise levels for all HVAC equipment.

#### **1.05 NOISE CONTROL FOR AIRHANDLING EQUIPMENT**

- A. 2" thick lined ductwork in main SA and RA ductwork near airhandling equipment in locations shown and as scheduled in the Project Documents.
- B. Minimum 5' long 1" thick lined runouts or acoustical flex runouts shall be provided between dampers and SA outlets or RA intakes at all spaces scheduled at NC-40 or quieter.
- C. Roof Curb Mass Infill at Rooftop Units: Infill roof curbs with BRD Hushcore Deck curb infill system or equivalent system approved by the project Acoustical Consultant.

#### **1.06 NOISE CONTROL FOR GRILLES, REGISTERS, AND DIFFUSERS**

- A. Maximum allowable sound levels for all grilles, registers, and diffusers shall not exceed the values for the equipment listed in the project documents and/or used as the basis of design for this project.
- B. Submit a tabulation of proposed products, maximum allowable noise criteria, and product noise criteria (at specified air volumes) for all project spaces.

#### **1.07 VIBRATION CONTROL FOR HVAC SYSTEMS**

- A. Vibration or noise from HVAC equipment and systems shall not be transmitted to building structure and components, including, but not limited to, roofs, floors, beams, columns, walls, partitions, ceilings, studs, ceiling framing and suspension systems.

1. Furnish all labor, equipment, and components necessary for HVAC equipment and system vibration control, including, but not limited to vibration isolators, bases, seismic restraints, incidental equipment, and related materials. Assure that deflection, stability and seismic restraint requirements are met. Install, test, and adjust all vibration isolation equipment per the manufacturer's instructions.
  2. Isolator and spring static deflections are based on typical, anticipated equipment characteristics, particularly rpm. The Manufacturer shall evaluate the equipment and propose appropriate or alternate static deflections as necessary.
  3. The Manufacturer shall be responsible for all vibration isolation and seismic control equipment and have no less than five years experience in fabrication and delivery of such equipment.
  4. The seismic resistance capability of all equipment shall be certified by a registered professional engineer in the state in which the project resides. The requirements of all applicable codes shall be met.
- B. Insure that functional integrity, structural integrity, and warranties of HVAC equipment and systems are not compromised by installation of vibration isolation equipment.
- C. Satisfy the requirements of all applicable codes.
- D. The vibration isolation equipment Manufacturer's responsibilities shall include the following.
1. Provide written installation instructions to the Contractor.
  2. Provide necessary visits to the jobsite before and after equipment is installed to identify pre-installation issues and post-installation discrepancies and necessary corrective work.
- E. The Contractor's responsibilities shall include the following.
1. Rigorously avoid short-circuiting of vibration-isolated HVAC equipment and systems to building structure and components. Oversee all trades to prevent the short-circuiting of any vibration isolation system and bring conflicts to the Architect's attention.
  2. Remove temporary blocking washers and shims after equipment installations are complete and HVAC equipment and systems are at operation weight.
  3. Obtain "rough-in" and final inspections by the Manufacturer and/or Architect prior to any permanent closure or covering.
  4. All installations that are deemed defective in workmanship or materials by the Manufacturer and/or Architect shall be corrected at no additional cost to the Owner.
- F. Submittals by the Manufacturer shall include the following:

1. Manufacturer's recommended installation instructions and procedures, including written instructions and checklists to be delivered to the Contractor to aid in proper installation of manufacturer's equipment.
  2. A schedule indicating tag number, location and type of all vibration isolators. This shall be sufficiently clear to suffice as a checklist and index for design load, static deflection expected under the design load, specified minimum static deflection, additional deflection to solid under design load, ratio of spring height to spring diameter under design load.
  3. Shop drawings of seismic restraints, steel brackets, steel rails, steel base frames, and concrete inertia bases showing all steel work, reinforcing, and vibration isolator and seismic restraint mounting attachment methods.
  4. Calculations by a structural engineer licensed in the state in which the building is to be erected, certifying that all seismic restraints, bolts, cables and associated components will conform with all applicable code requirements.
  5. List of any contract discrepancies or field conditions which will limit the performance of vibration isolation equipment and components.
- G. Submittals by the Contractor (at project completion) shall include the following:
1. A complete tabulation showing for each vibration isolator: (a) the actual static deflection measured at the project and (b) the specified minimum static deflection. Assistance from the vibration isolation equipment Manufacturer may be required.
  2. A report certifying a) that each piece of rotating mechanical equipment does not exceed the maximum displacement levels required in this section.
- H. Vibration isolation shall be provided at all vibration-producing HVAC equipment, including but not limited to rooftop ACUs.

#### **1.08 VIBRATION CONTROL FOR PIPING SYSTEMS**

- A. Vibration or noise from plumbing or HVAC piping shall not be transmitted to building structure and components, including, but is not limited to roofs, floors, beams, columns, walls, partitions, ceilings, studs, ceiling framing and suspension systems.
- B. Vibration isolation shall be provided at all active piping systems within the building, unless otherwise directed by the Architect. Specific vibration isolation equipment includes, but is not limited to equipment described in this section, and plumbing drawings and schedules for vibration isolation do not supersede this section.
- C. Insure that functional integrity, structural integrity, and manufacturers warranties for piping systems are not compromised by installation of vibration isolation equipment.
- D. Satisfy the requirements of all applicable codes.

#### **1.09 VIBRATION CONTROL FOR INDOOR TRANSFORMERS**

- A. Vibration or noise from indoor transformers shall not be transmitted to building structure and components, including, but is not limited to roofs, floors, beams, columns, walls, partitions, ceilings, studs, ceiling framing and suspension systems.
- B. Vibration isolation shall be provided at all transformers within the building. Support transformers on neoprene isolators sized for minimum static deflections of 0.2" under transformer load.
- C. All conduit connections to transformers shall be made resilient via sufficient lengths of flexible conduit (with wires pulled) to allow 1" free movement in any direction at mid span.
- D. Insure that functional integrity, structural integrity, and manufacturers warranties for transformers are not compromised by installation of vibration isolation equipment.
- E. Satisfy the requirements of all applicable codes.

**PART 2 PRODUCTS FOR NOISE AND VIBRATION CONTROL**

**2.01 DUCT AND PLENUM LINER**

- A. Duct or plenum lining at specified thicknesses and densities shall have the following minimum octave band sound absorption coefficients when tested in the F-25 Mounting configuration in accordance with ASTM E 795:

	Octave Band Ctr. Frequency in Hertz					
	125	250	500	1000	2000	4000
1"-thick, 2.0pcf:	.15	.50	.55	.80	.85	.95
2"-thick, 2.0pcf	.25	.75	.90	.95	.95	.95

**2.02 ACOUSTICAL FLEXIBLE DUCT**

- A. Flexible insulated round duct, with sound-transparent inner liner constructed of spun-bonded nylon.
- B. Must comply with all applicable codes and UL requirements.

**2.03 ROOF CURB INFILL SYSTEM**

- A. The roof curb infill system shall be BRD Hushcore Deck curb infill system or equivalent system approved by the project Acoustical Consultant..

**2.04 VIBRATION ISOLATION PRODUCTS**

- A. All vibration isolation equipment and associated seismic restraint equipment shall be warranted against defective workmanship, operation and materials for the life of the equipment supported by vibration isolation equipment.
- B. Vibration Isolators (including, but not limited to the following):



1. Steel Spring Isolation Curbs for Rooftop ACUs and as Needed: Minimum 2" deflection RSC by Mason or approved equal.
  2. Steel Spring Isolators for Condensing Units and as Needed: Minimum 1" deflection SSLFH by Mason or approved equal.
  3. Neoprene Isolators for Indoor Transformers and as Needed: Minimum 0.2" deflection "BR" by Mason or approved equal.
  4. Steel Spring Hangers for Suspended Fans, FCUs and as Needed: Minimum 2" deflection "30" by Mason or approved equal.
- C. Flexible Connectors and Sleeves (including, but are not limited to the following):
1. Flexible Pipe Connectors: "MFTNC, MFNEC or MFTFU" by Mason or approved equal.
  2. Flexible Duct Connectors: "KNC-100B" by Peabody or equal.
  3. Flexible Electrical Connection: Flexible conduit installed grossly slack.
  4. Field-Fabricated Resilient/ Airtight Sleeve: Oversized sleeve around pipe, conduit, or duct penetration. 1" clearance all around penetrating element, packed with glass fiber and sealed with at least 1/2" deep bead of acoustical sealant.

### **PART 3 COMMISSIONING REQUIREMENTS FOR NOISE AND VIBRATION CONTROL**

#### **3.01 BUILDING SYSTEMS NOISE MEASUREMENTS AND ADJUSTMENTS**

- A. Building system noise measurements shall be arranged and paid for by the Contractor after construction is complete as part of the acoustical commissioning process.
- B. Testing and reporting shall be as required in the latest edition of ANSI/ASA Standard S12.60.
- C. Building system noise measurements shall be carried out by a qualified acoustical consultant (as defined in Section 01 81 22), or a Test and Air Balance Contractor trained and certified to make noise measurements (in coordination with a qualified acoustical consultant, if necessary).
- D. Should any noise levels exceed the maximum allowable levels published in this section, the Contractor shall cooperate by making equipment and system adjustments at no cost to the Owner until the noise levels are at or less than the maximum allowable levels (or minimized to the greatest possible extent).

#### **3.02 VIBRATION ISOLATION SYSTEM MEASUREMENTS AND ADJUSTMENTS**

- A. Vibration isolation system adjustments shall be arranged and paid for by the Contractor as part of the mechanical systems commissioning process.

- B. After each equipment unit installation is complete and under full operational load, vibration isolators shall be adjusted so that loads are transferred to them and away from temporary blocking washers and shims. Blocks and shims then shall be removed and used as gauges to judge required clearances. Washers shall be moved away.
- C. Inspect all vibration-isolated equipment, coordinate the work of all involved trades, and see that vibration isolators are not short-circuited by seismic restraints, drain lines, conduits, stanchions, control tubing, duct connections, pipe connections, etc. Ensure that hanger isolators and their rods or wires do not touch any other building component.
- D. Schedule final inspection(s) by the equipment Manufacturer after installation as needed. Obtain "rough-in" inspection by the Manufacturer of any installation to be covered or enclosed, prior to such closure.
- E. Should any equipment be deemed to have excessive vibration by the project Architect or Acoustical Consultant, vibration measurements shall be carried out. If vibration levels exceed the maximum allowable levels published in this section, equipment adjustment or replacement shall be provided at no cost to the Owner until the vibration levels are at or less than the maximum allowable levels.

**END OF SECTION 01 81 23**

**SECTION 02 4116  
BUILDING DEMOLITION**

**PART 1 GENERAL**

**1.01 SECTION INCLUDES**

- A. Demolition of designated structures and removal of materials from site.
- B. Demolition and removal of foundations and slabs on grade.
- C. Demolition and removal of site paving.
- D. Disconnecting and removal of identified utilities.

**1.02 RELATED SECTIONS**

- A. Section 01 5000 - Temporary Facilities and Controls: Barriers, Fences and Landscape Protection.
- B. Section 01 6000 - Product Requirements.
- C. Section 01 7513 - Execution Requirements: Re-installation of removed components.
- D. Section 01 7000 - Closeout Submittals: Project record documents.
- E. Section 01 7419 - Construction Waste Management.
- F. Section 02 4119 - Minor Demolition for Remodeling.
- G. Divisions 31 & 32: Pertinent sections specifying clearing outside periphery of structures and backfilling below-grade areas where demolition items are removed.

**1.03 SUBMITTALS**

- A. See Section 01 3300 - Submittals, for submittal procedures.
- B. Project Record Documents: Accurately record actual locations of capped utilities.

**1.04 QUALITY ASSURANCE**

- A. Demolition Firm: Company specializing in type of work required by this section, with minimum five (5) years of documented experience.

**1.05 REGULATORY REQUIREMENTS**

- A. Conform to applicable code for demolition of structures, safety of adjacent structures, dust control.
- B. Obtain required permits from authorities.
- C. Notify affected utility companies before starting work and comply with their requirements.
- D. Do not close or obstruct roadways without permits.
- E. Conform to applicable regulatory procedures when hazardous or contaminated materials are discovered.

**PART 2 PRODUCTS**

**2.01 MATERIALS**

- A. Fill Material: As specified in Division 31.

### **PART 3 EXECUTION**

#### **3.01 PREPARATION**

- A. Provide, erect, and maintain temporary barriers and security devices at locations indicated.
- B. Protect existing landscaping materials, appurtenances, and structures that are not to be demolished.
- C. Prevent movement or settlement of adjacent structures. Provide bracing and shoring.
- D. Mark location of utilities.

#### **3.02 DEMOLITION REQUIREMENTS**

- A. Conduct demolition to minimize interference with adjacent structures.
- B. Cease operations immediately if adjacent structures appear to be in danger. Notify Owner; do not resume operations until directed.
- C. Conduct operations with minimum interference to public or private accesses. Maintain protected egress and access at all times.
- D. Obtain written permission from adjacent property owners when demolition equipment will traverse, infringe upon or limit access to their property.
- E. Sprinkle demolition areas with water to minimize dust. Provide hoses and water connections for this purpose.

#### **3.03 DEMOLITION**

- A. Disconnect and cap designated utilities within demolition areas. Remove disconnected utilities.
- B. Remove foundation walls and footings to a minimum of two feet (600 mm) below finished grade beyond area of new construction.
- C. Remove concrete slabs on grade.
- D. Break up site paving in areas indicated.
- E. Remove materials to be retained or re-installed in a manner that will prevent damage. Store and protect in accordance with requirements of Section 01 6000.
- F. Backfill areas excavated caused as a result of demolition, in accordance with Section 31 2323.
- G. Rough grade and compact areas affected by demolition to maintain site grades and contours.
- H. Remove demolished materials from site per the Construction Waste Management program.
- I. Do not burn or bury materials on site. Leave site in clean condition.
- J. Remove temporary work.

#### **3.04 SCHEDULES**

- A. Relics, antiques, and similar objects remain the property of Owner. Obtain direction regarding method of removal.

**END OF SECTION**

**SECTION 02 4119**  
**MINOR DEMOLITION FOR REMODELING**

**PART 1 GENERAL**

**1.01 SECTION INCLUDES**

- A. Remove existing work as indicated and as necessary to permit new work.
  - 1. Removal of designated building equipment and fixtures.
  - 2. Removal of designated construction.
- B. Disposal of materials.
- C. Identification of utilities.
- D. Salvaging, storing, and protecting existing work to remain or to be removed and re-installed.

**1.02 RELATED SECTIONS**

- A. Section 01 1100 - Summary: Work sequence and continued occupancy of the building.
- B. Section 01 5000 - Temporary Facilities and Controls: Temporary enclosures, dust control barricades, security at occupied areas, and cleanup during construction.
- C. Section 01 7513 - Execution Requirements: Re-installation of removed components.

**1.03 SUBMITTALS**

- A. See Section 01 3300 - Submittals, for submittal procedures.
- B. Project Record Documents: Accurately record actual locations of capped utilities.

**1.04 REGULATORY REQUIREMENTS**

- A. Conform to TITLE 24 CBC code for demolition work, dust control, products requiring electrical disconnection and re-connection .
- B. Do not close or obstruct egress from any building exit or site exit.
- C. Do not disable or disrupt building fire or life safety systems without 10 (ten) days prior written notice to Owner.
- D. Conform to applicable regulatory procedures when hazardous or contaminated materials are discovered.

**1.05 SEQUENCING**

- A. Sequence work under the provisions of Section 01 3200.

**1.06 SCHEDULING**

- A. Schedule work under the provisions of Section 01 3200.
- B. Schedule work to coincide with new construction.
- C. Coordinate demolition with other trades to assure the proper sequence, limits, methods and time of performance. Schedule work so as to impose a minimum of hardship on the present operation of facilities and the performance of the work of other trades or contracts.
- D. Perform noisy, malodorous, or dusty work. Conform to more stringent requirements of local authorities having jurisdiction, when applicable:
  - 1. Between the hours of 7:00 am and 5:00 pm.

### **1.07 PROJECT CONDITIONS**

- A. Conduct demolition to minimize interference with adjacent and occupied building areas.
- B. Use all means necessary to protect existing objects, construction and plantings designated to remain. In the event of damage, make all repairs and replacements necessary for approval of Architect at no additional cost to the Owner.
- C. Protective measures: Provide all necessary safeguards, including warning signs and lights, barricades, and the like, for protection of the public, Contractor's employees and existing improvements during demolition. Prevent access of unauthorized persons to area of work
- D. Provide at least one person who shall be present at all times during execution of this portion of the work, be thoroughly familiar with the type of work being performed and the best methods for its execution and who shall direct all work performed under this Section.
- E. Control the use of water to prevent damage to the existing facilities to remain. Provide wet vacuum equipment where water, such as waste cooling water from concrete sawing or water used as dust emollient, is used adjacent to and in existing buildings.
- F. Cease operations immediately if structure appears to be in danger and notify Architect. Do not resume operations until directed.

### **PART 2 PRODUCTS - NOT USED.**

### **PART 3 EXECUTION**

#### **3.01 PREPARATION**

- A. Provide, erect, and maintain temporary barriers at locations indicated.
- B. Inspect the area of work and verify locations of all items designated to be removed or preserved.
- C. Do not begin demolition work until temporary barricades, warning signs and other forms of protection are installed.
- D. Erect and maintain weatherproof closures for exterior openings.
- E. Erect and maintain temporary partitions to prevent spread of dust, odors, and noise to permit continued occupancy of adjacent buildings.
- F. Protect existing materials and features that are not to be demolished.
- G. Prevent movement of structure; provide bracing and shoring.
  - 1. Be responsible for the adequacy and design of all temporary shoring and bracing systems.
- H. Notify affected utility companies before starting work and comply with their requirements.
- I. Mark location and termination of utilities.
- J. Provide appropriate temporary signage including signage for exit or building egress.

#### **3.02 DEMOLITION**

- A. Disconnect, remove, and identify designated utilities within demolition areas.
- B. Demolish in an orderly and careful manner. Protect existing supporting structural members and features indicated to remain.

1. Cut openings in existing walls or roofs at locations necessary to accommodate new doors, windows, ductwork, piping, conduits, raceways or other building services or elements.
  2. Demolish concrete curbs at locations of walls to be removed.
  3. Remove dry-rotted wood materials and other unsuitable materials as indicated and as required to provide sound substrates for other work.
  4. Use of explosives will not be permitted.
- C. Remove existing glazing, sealants, stops, and other elements at existing hollow metal frames indicated to receive new operable sash.
- D. Remove existing glazing, sealants, stops, trim and other elements of existing windows indicated to be replaced with new windows. Coordinate full extent of demolition with Section 08 5113 and Section 06 2000.
- E. Remove existing flooring, wall coverings, trim or other finishes in areas designated to receive new work.
- F. Remove existing construction only to the extent necessary for the proper installation of new construction and junction with existing work. Cut back finished surfaces to straight, plumb or level lines as required.
- G. Mechanical, Plumbing and Electrical systems : Demolish existing improvements as required to permit installation of new systems indicated. Refer to pertinent sections of Divisions 22, 23 and 26 for additional specific demolition required for mechanical, plumbing and electrical systems.
- H. Securely seal exposed ends of existing ductwork systems left open by demolition operations. Prevent entry of foreign matter. Protect these seals from damage until connected to new work.
- I. Remove all fasteners, anchors, supports and similar appurtenances from substrates indicated to remain. Leave substrates in good condition to receive new work.
1. Pull nails from wood framing. Unthread screws, do not pull out. Do not drive existing nails or screws flush.
  2. Remove suspended ceiling support wires.
  3. Remove staples, screws, and miscellaneous anchors from all gypsum board, wood paneling, masonry wall surfaces indicated to remain.
- J. Demolish as follows:
1. Portland cement concrete, asphalt concrete paving: Saw cut or core drill; jack-hammering of central areas away from saw-cut joint is acceptable for removing large areas of concrete. Cut back concrete or paving to clean, straight saw-cut lines. Provide wet vacuum equipment as required for control of waste cooling water.
  2. Modular materials such as ceiling, resilient and ceramic tile: Remove to a natural point of division in whole units to a joint line with no damaged or defective unit remaining to adjoin new construction.
  3. Gypsum wallboard: Remove to a joint line on a support.
  4. Wood trim: Remove to a natural existing joint line.
- K. Examine substrates and surfaces exposed by demolition for water damage, dryrot, decay, termite infestation or other structural failure. Request direction from the Architect if these conditions are discovered. Additional demolition beyond scope originally indicated may be required to fully remove damaged or unsuitable materials.

- L. Work not mentioned to be removed that interferes with new construction shall be cut to clean cut lines to provide for proper interface with new construction, or patching and repair, as required.
- M. All holes or trenches created by removal of underground piping or other facilities demolished shall be filled with clean soil and compacted to the density for fills specified. Do not backfill if subsequent excavation will occur at the same location. Do not backfill hole or trenches until inspected by the Soils Engineer or IOR.
- N. Remove demolished materials from site except where specifically noted otherwise. Do not burn or bury materials on site.
- O. Remove materials as demolition progresses. Upon completion of demolition, leave areas in clean condition.
- P. Remove temporary facilities.

### **3.03 SALVAGE**

- A. Items indicated to be salvaged shall be removed carefully, cleaned and stored in a protected location on or off the site until re installed; salvaged items to be delivered to the Owner shall also be removed carefully and presented to the Owner's designated representative.
- B. Owner may take possession of any items of salvage for his use if he desires. Provide incidental labor to relocate designated salvage for Owner's storage.
- C. Salvage existing wood trim of unique or unusual profile. Stockpile and re-install in new locations. Minimize provision of new materials.
- D. Salvage existing acoustic ceiling tile of unique or unusual patterns. Stockpile and re-install in new locations where patching is necessary to install new work of other sections. Minimize provision of new materials.

### **3.04 PATCHING**

- A. Patch materials to remain when damaged by this work. Finish materials and appearance of the patch or repair work shall match the existing contiguous materials and finishes in all respects and shall be approved by Architect.
- B. Where openings are cut oversize or in improper location, replace the excess removed material as instructed by Architect at no additional cost to the Owner.

### **3.05 CLEAN-UP AND DISPOSAL**

- A. Debris, waste, and removed materials, other than items to be salvaged, are Contractor's property for legal disposal off the site, as required by applicable Federal and State regulations. Continuously clean up and remove these items. Do not allow demolished items to accumulate. All materials to be disposed, shall meet the requirements of the Construction Waste Management program.
- B. Leave the site in a neat and orderly condition prepared for the work of other trades.

**END OF SECTION**



## SECTION 03 1000

### CONCRETE FORMING AND ACCESSORIES

#### PART 1 - GENERAL

##### 1.01 SUMMARY

- A. Section Includes: All labor, materials and equipment and all operations required to complete all formwork as indicated on the drawings; to produce shapes and configurations as shown, as required; and as specified herein, including:
  - 1. Forms, shores, bracing, removal and other operations as necessary for all cast-in-place concrete and masonry placed.
  - 2. Setting and securing anchor bolts and other metal items embedded in concrete into formwork, using materials and layouts furnished and delivered to jobsite as specified under other sections.
- B. Related Sections:
  - 1. Pertinent Sections of Division 03 specifying concrete construction.
  - 2. Pertinent Sections of other Divisions specifying work to be embedded in concrete or work penetrating concrete foundations and formwork.

##### 1.02 REFERENCES

- A. California Code of Regulations, Title 24, latest adopted edition (herein noted as CBC): Chapter 19A Concrete.
- B. American Concrete Institute (ACI) 347 "Recommended Practice for Concrete Formwork".
- C. American Plywood Association (APA) "Concrete Forming Guide".
- D. West Coast Lumberman Inspection Bureau (WCLIB) "Standard Grading Rules for West Coast Lumber".
- E. ACI SP-066 "ACI Detailing Manual".
- F. ACI 301 "Specifications for Structural Concrete".
- G. Concrete Reinforcing Steel Institute (CRSI) "Manual of Standard Practice".

##### 1.03 DESIGN REQUIREMENTS

- A. Design, engineer, and construct formwork, shoring and bracing to conform to design and code requirements, resist imposed loads; resultant concrete to conform to required shape, line and dimension.

##### 1.04 SUBMITTALS

- A. Limitation of review: Structural Engineer's review will be required only where specifically requested for general architectural applications and features only. Contractor is responsible for structural stability, load-resisting characteristics and sufficiency of form work design.

## 1.05 QUALITY ASSURANCE

- A. General: All form materials shall be new at start of work. Produce high quality concrete construction. Minimize defects due to joints, deflection of forms, roughness of forms, nonconforming materials, concrete or workmanship.
- B. Reuse of Forms: Plywood forms may be reused, if thoroughly cleaned of all dirt, mortar, and foreign materials, and undamaged at edges and contact face. Reuse shall be subject to permission from the Architect without exception, and issued in writing. Reuse of any panel which will produce a blemish on exposed concrete, will not be permitted.

## PART 2 - PRODUCTS

### 2.01 MATERIALS

- A. Form Materials:
  - 1. Non-Exposed Surface Formwork Facing: Forms for concrete which is not exposed to view, may be of plywood as specified for exposed surfaces, or square edge 1x nominal Douglas Fir, Construction Grade, S4S.
  - 2. Exposed Surface Formwork Facing:
    - a. Forms for all exterior and interior concrete flat surfaces unless otherwise specified as board formed shall be new Douglas Fir Plywood (APA) ply, 5/8-inch, B-B Plyform, Class 1, Exterior Type, oiled and edged and edge-sealed conforming to U.S. Product Standard PS 1 in large sheet sizes to achieve joint patterns shown.
    - b. All exposed concrete edges shall be chamfered 3/4" minimum or as noted on the drawings.
  - 3. Exposed Surface Formwork - Special Pattern Form Liner:
    - a. Forms for all exterior and interior concrete flat surfaces indicated shall be as designated by Architect.
- B. Earth Forms: Allowed, subject to soil standing in excavations without ravel or caving.
- C. Form Release Agent: Spray-on compound, not affecting color, bond or subsequent treatment of concrete surfaces. Maximum VOC content shall comply with local requirements and California Green Building Code.
- D. Accessories: Types recommended by manufacturers or referenced standards to suit conditions indicated;
  - 1. Anchors, spacers, void in-fill materials: sized to resist imposed loads.
  - 2. Form Ties: Prefabricated rod, flat band, or wire snap ties with 1" break-back or threaded internal disconnecting type with external holding devices of adequate bearing area. Ties shall permit tightening and spreading of forms and leave no metal closer than 1" to surface.
- E. Corner Chamfers and Rustications: Filleted, wood strip or foam type; sizes and shapes as detailed, or 3/4 x 3/4 inch size minimum if not detailed; maximum possible lengths.

- F. Nails, Spikes, Lag Bolts, Through Bolts, Anchorages: Sized as required, of sufficient strength and character to maintain formwork in place while placing concrete.

### **PART 3 - EXECUTION**

#### **3.01 EXAMINATION**

- A. Inspect the substrate and the conditions under which concrete formwork is to be performed. Correct conditions detrimental to timely and proper completion of the work. Do not proceed with the work until unsatisfactory conditions have been corrected. Commencement of work indicates acceptance of substrates and conditions.
- B. Verify lines, levels and centers before proceeding with formwork. Ensure that dimensions agree with drawings.

#### **3.02 EARTH FORMS**

- A. If natural soil or compacted fill can be accurately cut and maintained, foundations and grade beams may be poured against earth without forming. Provide positive protection of trench top corners.
- B. Maintain earth forms free of water and foreign materials.

#### **3.03 ERECTION - FORMWORK**

- A. General: Construct formwork in accordance with calculations, and recommendations of Section 401 of ACI 347. Construct forms to the sizes, shapes, lines and dimensions shown, and as required to obtain accurate alignment, location, grades, level and plumb work in finished structure. Provide for openings, offsets, sinkages, keyways, recesses, moldings, rustications, reglets, chamfers, blocking, screeds, bulkheads, anchorages and inserts, and other features required. Use selected materials to obtain required finishes.
  - 1. Construct cambers specified in concrete members and slabs in the formwork.
  - 2. Schedule the work and notify other trades in ample time so that provisions for their work in the formwork can be made without delaying progress of the project. Install all sleeves, pipes, etc. for building services systems, or other work. Secure information about and provide for all openings, offsets, recessed nailing blocks, channel chases, anchors, ties, inserts, etc. in the formwork before concrete placement.
  - 3. Deflection: Formwork and concrete with excessive deflection after concrete placement will be rejected. Excessive deflection is that which will produce visible and noticeable waves in the finished concrete.
  - 4. Measure formwork for elevated structural slabs, columns, wall elevations points of maximum camber and submit in writing to the Architect/Engineer prior to placing concrete.
- B. Formwork Construction: Erect formwork, shoring and bracing to achieve design requirements, in accordance with requirements of ACI 301. Uniform, substantial and sufficiently tight to prevent leakage of concrete paste, readily removable without impact, shock or damage to cast-in-place concrete surfaces and adjacent materials. Tie, brace, shore, and support to insure stability against pressures from any source, without failure of any component part and without excessive deflection. Solidly butt joints and provide backup material at joints as required to prevent leakage and fins.

- C. Provide all openings, offsets, inserts, anchorages, blocking, and other features of the work as shown or required. See INSERTS, EMBEDDED PARTS, AND OPENINGS for detailed requirements.
- D. Warped, checked, or scuffed forms will be rejected.
- E. Maintain membranes, reinforcing and other work free of damage; protect with plywood runway boards or other positive, durable means.
- F. Align joints and make watertight. Keep form joints to a minimum.
- G. Provide fillet and chamfer strips on external corners of exposed locations and as indicated to form patterns in finished work. Extend patterns around corners and into alcoves, on backs of columns and similar locations not otherwise shown.
  - 1. Produce beveled, smooth, solid, unbroken lines, except as otherwise indicated to conform to patterns.
  - 2. Form corners and chamfers with 3/4 inch x 3/4 inch strips, unless otherwise indicated, accurately formed and surfaced to produce uniformly straight lines and tight edge joints. Extend terminal edges to required limit and miter chamfer at changes in direction.
- H. Unexposed corners may be formed either square or chamfered.
- I. Ties and Spreaders: Arrange in a pattern acceptable to the Architect when exposed. Snap-ties may be used except at joints between pours where threaded internal disconnecting type shall be used.
- J. Coordinate this section with other sections of work that require attachment of components to formwork.
- K. Reglets and Rebates: Accurately locate, size, and form all reglets and rebates required to receive work of other trades, including flashing, frames, and equipment.

#### **3.04 APPLICATION - FORM RELEASE AGENT**

- A. Apply form release agent on formwork in accordance with manufacturer's recommendations.
- B. Apply prior to placement of reinforcing steel, anchoring devices, and embedded items.
- C. Do not allow excess form coating material to accumulate in the forms or to come into contact with reinforcement or surfaces which will be bonded to fresh concrete.
- D. Coat steel forms with a non-staining, rust-preventative form oil or otherwise protect against rusting. Rust-stained steel formwork will be rejected.
- E. Leave no residue or stain on the face of the concrete, nor affect bonding of subsequent finishes or work specified in other sections.

#### **3.05 INSERTS, EMBEDDED PARTS, AND OPENINGS**

- A. Provide formed openings where required for items to be embedded in passing through concrete work.
  - 1. Provide openings in concrete formwork to accommodate work of other sections including those under separate contracts (if any). Size and location of openings, recesses and chases shall be in accordance with the section requiring such items. Accurately place and securely support items to be built into forms.
- B. Construction Joints: Construct and locate generally as indicated on Drawings and only at locations approved by Structural Engineer, so as not to impair the strength of the structure. Form keys in all cold joints shown or required.
- C. Locate and set in place items that will be cast directly into concrete.
- D. Rough Hardware and Miscellaneous Metal: Set inserts, sleeves, bolts, anchors, angles, and other items to be embedded in concrete. Set embedded bolts and sleeves for equipment to template and approved shop drawings prepared by trades supplying equipment.
- E. Coordinate with work of other sections in forming and placing openings, slots, reglets, recesses, sleeves, bolts, anchors, other inserts, and components of other work.
- F. Wood Inserts and Nailers: Provide approved preservative-treated lumber. Set all required nailing blocks, grounds, and other inserts as required to produce results shown. Wood plugs shall not be used.
- G. Install accessories in accordance with manufacturer's instructions, so they are straight, level, and plumb. Ensure items are not disturbed during concrete placement.
- H. Piping: Do not embed piping in structural concrete unless locations specifically approved by Structural Engineer.
- I. Conduit: Place conduit below slabs-on-grade and only as specifically detailed on structural drawings. Minimum clear distance between conduits shall be 3 diameters. Location shall be subject to Engineer's written approval and shall not impair the strength of the structure.
- J. Provide temporary ports or openings in formwork where required to facilitate cleaning and inspection. Locate openings at bottom of forms to allow flushing water to drain.
  - 1. Provide openings for the introduction of vibrators at intervals necessary for proper placement.
  - 2. Close temporary openings with tight fitting panels, flush with inside face of forms, and neatly fitted so joints will not be apparent in exposed concrete surfaces.
- K. Install Form Liner inserts in accordance with manufacturer's recommendations, to produce patterns and textures indicated.
- L. Install waterstops in accordance with manufacturer's recommendations to provide continuous waterproof barrier.

### 3.06 FORM CLEANING

- A. Clean forms as erection proceeds, remove foreign matter within forms.

- B. Clean formed cavities of debris prior to placing concrete.
  - 1. Remove all dirt, chips, sawdust, rubbish, water and foreign materials detrimental to concrete.
  - 2. Flush with water or use compressed air to remove remaining foreign matter. Ensure that water and debris drain to exterior through clean-out ports.

### **3.07 FOOTINGS**

- A. Verify elevations and provide final excavation required for footings prior to placing of concrete.

### **3.08 EQUIPMENT BASES**

- A. Form concrete bases for all mechanical and electrical equipment in accordance with approved shop details furnished by other sections.
- B. Sizes and locations as indicated and as required to produce results shown.
- C. Provide coved base for all equipment bases placed on concrete slabs.

### **3.09 FORMWORK TOLERANCES**

- A. Construct formwork to maintain tolerances required by ACI 301.

### **3.10 FIELD QUALITY CONTROL**

- A. Inspect erected formwork, shoring, and bracing to ensure that work is in accordance with formwork design, and to verify that supports, fastenings, wedges, ties, and items are secure.
- B. Do not reuse wood formwork more than 2 times for concrete surfaces to be exposed to view. Do not patch formwork.
- C. Clean and repair surfaces to be re-used in the work. Split, frayed, delaminated or otherwise damaged form facing material will not be acceptable. Apply new form coating compound material to concrete contact surfaces as specified for new formwork.
- D. When forms are extended for successive concrete placement, thoroughly clean surfaces, remove fins and laitance, and tighten forms to close all joints. Align and secure joints to avoid offsets.

### **3.11 FORM REMOVAL**

- A. Do not loosen or remove forms before minimum curing period has elapsed without employment of appropriate alternate curing methods, approved by the Architect in writing.
- B. Remove forms without damage to the concrete using means to insure complete safety of the structure and without damage to exposed beams, columns, wall edges, chamfers and inserts. Loosen forms carefully. Do not wedge pry bars, hammers, or tools against finish concrete surfaces scheduled for exposure to view.

- C. Do not remove forms until the concrete has hardened sufficiently to permit safe removal and the concrete has attained sufficient strength to safely support imposed loads. The minimum elapsed time for removal of forms after concrete has been placed shall be as follows:
  - 1. Columns and Walls: 7 days, provided members are not subjected to overhead loads.
  - 2. Retaining Walls: 21 days minimum.
  - 3. Footings: 7 days minimum. If backfilled immediately, side forms may be removed 24 hours after concrete is placed.
  - 4. Beams, elevated slab, and similar overhead conditions: 28 days unless adequate shoring is provided.
- D. Durations listed above are minimums and are subject to extension at the sole judgment of the Architect/Engineer.
- E. Reshoring: Reshore members where and if required by Formwork Design Engineer.
- F. Do not subject concrete to superimposed loads (structure or construction) until it has attained full specified design strength, nor for a period of at least 14 days after placing.
- G. Store removed forms to prevent damage to form materials or to fresh concrete. Discard damaged forms.

### **3.12 CLEANING**

- A. Remove excess material and debris associated with this work from the job site.

**END OF SECTION**

## SECTION 03 2000

### CONCRETE REINFORCING

#### PART 1 GENERAL

##### 1.01 SUMMARY

A. Section Includes:

1. Reinforcing steel work for all concrete and masonry work as indicated on the drawings and specified herein.
2. Coordinate this work with other work affected by these operations, such as forms, electrical work, mechanical work, structural steel, masonry and concrete.

B. Related Sections:

1. Pertinent Sections of Division 01 specifying Quality Control and Testing Laboratory services.
2. Pertinent Sections of Divisions 03 specifying concrete construction.
3. Pertinent Sections of Divisions 04 specifying masonry construction.
4. Pertinent Sections of other Divisions specifying work to be embedded in concrete or work penetrating concrete work.

##### 1.02 REFERENCE STANDARDS

- A. California Code of Regulations, Title 24, latest adopted edition (herein noted as CBC) Chapter 19A Concrete.
- B. American Concrete Institute (ACI) 301 "Specifications for Structural Concrete for Buildings".
- C. ACI 318 "Building Code Requirements for Reinforced Concrete and Commentary".
- D. ACI SP-066 "ACI Detailing Manual".
- E. American Society for Testing and Materials (ASTM) A1064 "Standard Specification for Steel Welded Wire Reinforcement, Plain, for Concrete".
- F. ASTM A615 "Standard Specification for Deformed and Plain Carbon-Steel Bars for Concrete Reinforcement".
- G. ASTM A706 "Standard Specification for Deformed and Plain Low-Alloy Steel Bars for Concrete Reinforcement".
- H. American Welding Society (AWS) D1.4 - "Structural Welding Code for Reinforcing Steel".
- I. Concrete Reinforcing Steel Institute (CRSI) "Manual of Standard Practice".

##### 1.03 SUBMITTALS

- A. Submit in accordance with pertinent sections of Division 01 specifying submittal procedures. Submit for review prior to fabrication.



- B. Limitation of Review: Structural Engineer's review will be for general conformance with design intent as indicated in the Contract Documents and does not relieve Contractor of full responsibility for conformance with the Contract Documents. The General Contractor shall review and approve shop drawings prior to submittal to the Architect/Engineer.
- C. Shop Drawings: Show complete fabrication and placing details of all reinforcing steel. Comply with requirements of ACI SP-66. Include:
  - 1. Bar sizes and schedules;
  - 2. Shapes of bent bars, layout and spacing of bars, location of splices.
  - 3. Stirrup spacing, arrangements and assemblies,
  - 4. References to Contract Document detail numbers and designations.
  - 5. Wall elevations corresponding to elevations shown in Contract Documents.
- D. Product Data: Submit manufacturer's product data, specifications, location and installation instructions for proprietary materials and reinforcement accessories. Provide samples of these items upon request.
- E. Certificates: Submit all certifications of physical and chemical properties of steel for each heat number as manufactured, including location of material in structure as specified below in Article titled QUALITY ASSURANCE. All materials supplied shall be tagged with heat numbers matching submitted Mill Test Report analyses.
- F. Samples: Provide to the Owner's Testing laboratory as specified in Article SOURCE QUALITY CONTROL.

#### **1.04 QUALITY ASSURANCE**

- A. Perform work of this Section in accordance with CRSI DA4, CRSI P1, ACI 301, and ACI 318.
- B. Requirements of Regulatory Agencies, refer to pertinent Sections of Division 01 and CBC.
- C. Certification and Identification of Materials and Uses: Provide Owner's Testing Agency with access to fabrication plant to facilitate inspection of reinforcement. Provide notification of commencement and duration of shop fabrication in sufficient time to allow inspection and all material identification/test information listed below.
  - 1. Provide manufacturer's Mill Test Reports for all materials. Include chemical and physical properties of the material for each heat number manufactured. Tag all fabricated materials with heat number.
  - 2. Provide letter certifying all materials supplied are from heat numbers covered by supplied mill certificates. Include in letter the physical location of each grade of reinforcing and/or heat number in the project (i.e. foundations, walls, etc.).
  - 3. Unidentified Material Tests: Where identification of materials by heat number to mill tests cannot be made, Owner's Testing Agency shall test unidentified materials as described below.
- D. Testing and Inspection: Tests and Inspections required by Independent Testing Agency are specified below in Articles SOURCE QUALITY CONTROL and FIELD QUALITY CONTROL. Duties and limitations of Independent Testing Agency, test costs and test reports in conformance with pertinent Sections of Division 01.

## 1.05 DELIVERY, STORAGE AND HANDLING

- A. Comply with pertinent requirements of Division 01.
- B. Deliver reinforcement to project site in bundles marked with durable tags indicating heat number, mill, bar size and length, proposed location in the structure and other information corresponding with markings shown on placement diagrams.
- C. Handle and store materials above ground to prevent damage, contamination or accumulation of dirt or rust.

## PART 2 PRODUCTS

### 2.01 MATERIALS

- A. Reinforcing Steel: Deformed billet steel bars, ASTM A706 Grade 60 or ASTM A615 Grade 60.
  - 1. Exception: Bars #3 and smaller shall be Grade 40 minimum, unless otherwise noted on the drawings.
  - 2. Welded reinforcement shall be ASTM A706, or A615 meeting carbon requirements of AWS D1.4. Welding shall conform with AWS D1.4.
  - 3. All reinforcement to be unfinished.
- B. Welded Wire Reinforcement: ASTM A1064.
- C. Tie Wire: No. 16 AWG or heavier, black annealed.
- D. Concrete Blocks: On-grade conditions only, as required to support reinforcing bars in position.
- E. Reinforcing Supports: Plastic or galvanized steel chairs, bolsters, bar supports, or spacers sized and shaped for adequate support of reinforcement and construction loads imposed during concrete placement, meeting ACI and CRSI standards.
  - 1. For use over formwork: Galvanized wire bar type supports complying with CRSI recommendations. Provide plastic tips where exposed to view or weather after removal of formwork. Do not use wood, brick, or other unacceptable materials.
- F. Reinforcement Splice Couplers: For use only where specified on drawings. Submit other locations proposed for use to Engineer for review. "L-Series Bar Lock" Coupler Systems for Splicing Reinforcement Bars, UES ER-0319, by Dayton-Superior Corporation.

### 2.02 FABRICATION

- A. Fabricate concrete reinforcing in accordance with CRSI (DA4), unless specifically shown otherwise. Details not specifically shown or indicated shall conform to SP-066 and specified codes and standards.
  - 1. Accurately shop-fabricate to shapes, bends, sizes, gauges and lengths indicated or otherwise required.

2. Bend bars once only. Discard bars improperly bent due to fabricating or other errors and provide new material; do not re-bend or straighten unless specifically indicated. Rebending of reinforcement in the field is not allowed.
  3. Do not bend reinforcement in a manner that will injure or weaken the material or the embedding concrete.
  4. Do not heat reinforcement for bending. Heat-bent materials will be rejected.
- B. Unacceptable materials: Reinforcement with any of the following defects will not be permitted in the work.
1. Bar lengths, depths and bends exceeding specified fabrication tolerances.
  2. Bends or kinks not indicated on Drawings or final shop drawings.
  3. Bars with reduced cross-section due to rusting or other cause.
- C. Tag reinforcement with durable identification to facilitate sorting and placing.
- D. Shop Fusion Welded Stirrup/Tie/Spiral Cages
1. Shop fusion welding of stirrup/tie/spiral cages is permitted to aid in fabrication and handling. The following requirements shall be met.
  2. All reinforcing bars receiving weld shall be ASTM A706.
  3. Longitudinal holding wires shall be ASTM A1064.
  4. Shop welding shall be performed by machines under a continuous, controlled process.
  5. Quality control tests shall be performed on shop-welded specimens and the test results shall be available, upon request, to the Architect/Engineer.
  6. Tack welding of reinforcing steel is not permitted.
  7. Welding of any type shall not occur at 90°, 135°, or 180° bends. Circular ties and spirals may be shop fusion welded outside of areas with 90°, 135°, or 180° hook bends.
  8. Longitudinal bars shall not be welded to stirrups/ties/spirals.

## 2.03 SOURCE QUALITY CONTROL

- A. The Testing Agency, as specified in the Article QUALITY ASSURANCE, will perform the following:
1. Sampling and Tests of Reinforcing Bars per CBC 1910A.2.
  2. Material Testing:
    - a. Identified Steel: When samples are taken from bundled steel identified by heat number, matched with accompanying mill analyses as delivered from the mill, Owner's Testing Agency will perform one tensile test and one bend test per each ten tons or fraction thereof for each required size of reinforcing steel.
    - b. Unidentified Steel: When identification of materials by heat number matched to accompanying mill analyses cannot be made, perform one tensile test and one bend test per each two and one-half tons or fraction thereof for each required size of reinforcing steel. Tests of unidentified steel shall be performed by the Owner's Testing Agency and costs for these tests shall be paid by the Contractor by deductive change order.

## PART 3 EXECUTION

### 3.01 EXAMINATION

- A. Inspect the conditions under which concrete reinforcement is to be placed. Do not proceed with the work until unsatisfactory conditions have been corrected.
- B. Coordinate with work of other sections to avoid conflicts or interference. Bring conflicts between reinforcement and other elements to Architect's attention. Resolve conflicts before concrete is placed.
- C. Notify Architect, Structural Engineer, and Authority Having Jurisdiction for review of steel placement not less than 48 hours before placing concrete.

### **3.02 PLACEMENT**

- A. General: Comply with the specified codes and standards, and Concrete Reinforcing Steel Institute recommended practice for "Placing Reinforcing Bars", for details and methods of reinforcement placement and supports, and as herein specified.
- B. Clean bars free of substances which are detrimental to bonding. Maintain reinforcement clean until embedded in concrete.
- C. Place reinforcement to obtain the minimum coverages for concrete protection. Do not deviate from required position. Maintain required distance, spacing and clearance between bars, forms, and ground.
- D. Location and Support: Provide metal chairs, runners, bolsters, spacers and hangers, as required.
- E. Provide additional steel reinforcement as necessary or as directed, to act as spreaders or separators to maintain proper positioning.
- F. Tying and Attachment: Securely tie at all intersections and supports with wire. Prevent dislocation or movement during placement of concrete. Direct twisted ends of wire ties away from exposed concrete surfaces.
- G. Separate reinforcing from pipes or conduits with approved non-metallic separators. Do not use wood or steel form stakes or reinforcement used as stakes as support for reinforcement.
- H. Accommodate placement of formed openings required by other sections.
- I. Obstructions:
  - 1. Where obstructions, block-outs, or penetrations (conduits, raceways, ductwork) prevent continuous placement of reinforcement as indicated, provide additional reinforcing as detailed and as directed by the Structural Engineer to supplement the indicated reinforcement around the obstruction.
  - 2. Place additional trim bars, ties, stirrups, or other elements as detailed and as directed at all opening, sleeves, pipes or other penetrations through structural elements.

### **3.03 REINFORCING SPACING AND COVERAGE**

- A. Spacing: Do not space bars closer than four (4) diameters of the largest of two adjacent bars, except at bar laps, which shall be placed such that a minimum of 2 bar diameters is clear between bars.
- B. Where reinforcing in members is placed in two layers, the distance between layers shall not be less than four bar diameters of the largest bar and the bars in the upper layers shall be placed directly above those in the bottom layer, unless otherwise detailed or dimensioned.
- C. Coverage of bars (including stirrups and columns ties) shall be as follows, unless otherwise shown:
  - 1. Footings and Mat Foundation: 3 inches to any soil face, 2 inches to top.
  - 2. Slabs (on grade): 2 inches to grade face, 1-1/2 inches to top face.
  - 3. Walls: 1-1/2 inches clear to form and 2 inches clear to form at soil face.

### **3.04 DOWELS, SPLICES, OFFSETS AND BENDS**

- A. Provide standard reinforcement splices at splices, corners, and intersections by lapping ends, placing bars in contact, and tightly tying with wire at each end. Comply with details shown on structural drawings and requirements of ACI 318.
- B. Provide minimum 1-1/2 inch clearance between sets of splices. Stagger splices in horizontal bars so that adjacent splices will be 4 feet apart.
- C. Laps of welded wire reinforcement shall be at least two times the spacing of the members in the direction lapped but not less than twelve inches.
- D. Splices of reinforcement shall not be made at points of maximum stress. Provide splice lengths as noted on the structural drawings, with sufficient lap to transfer the stress between bars by bond and shear.
- E. Spacing:
  - 1. Space bars minimum distance specified and all lapped bars 2 bar diameters (minimum) clear of the next bar.
  - 2. Stagger splices of adjacent bars where possible and where required to maintain bar clearance.
  - 3. Beam or slab top bars shall be spliced mid-span of column support and bottom bars spliced at column supports.
  - 4. Request Architect/Engineer review prior to placement for all splices not shown on the drawings.
- F. Reinforcement Couplers: Install at all locations indicated. Install couplers in accordance with manufacturer's recommendations.

### **3.05 WELDING**

- A. No reinforcing shall be welded unless specifically indicated. No reinforcing shall be welded without prior approval of the Structural Engineer and the Authority Having Jurisdiction.
- B. Only when so approved for use as noted above, all welding shall conform to AWS D1.4, ACI 318 Section 26.6.4, and CBC 1903A.8 and the following;

1. All welding performed by certified welders.
2. All reinforcement requires preheat prior to welding. All preheat and welding shall be continuously inspected by the Testing Agency.

**3.06 MISPLACED REINFORCEMENT**

- A. Notify Architect/Engineer immediately if reinforcing bars are known to be misplaced after concrete has been placed.
- B. Perform no correction or cutting without specific direction. Do not bend or kink misplaced bars.
- C. Correct misplaced reinforcing only as directed in writing by the Architect/Engineer. Bear all costs of redesign, new, or additional reinforcing required because of misplaced bars at Contractor's expense.

**3.07 FIELD QUALITY CONTROL**

- A. The Testing Agency as specified in the Article QUALITY ASSURANCE, will inspect the work for conformance to contract documents before concrete placement.
  1. Inspection: Provide inspection and verification of installed reinforcement. Confirm that the surface of the rebar is free of form release oil or other coatings.
  2. Inspect all preheat and welding activities for steel reinforcement, when these occur.
  3. Exception: Non-structural patios, driveways, and sidewalks do not require special inspection.

**3.08 CLEANING**

- A. Remove excess material and debris associated with this work from the job site.

**END OF SECTION**

## SECTION 03 3000

### CAST-IN-PLACE CONCRETE

#### PART 1 GENERAL

##### 1.01 SUMMARY

- A. Section Includes: Provide all labor, materials, equipment and services to complete all concrete work required, including, but not limited to, the following:
1. Foundations, slabs-on-grade, and retaining walls.
  2. Installation of all bolts, inserts, sleeves, connections, etc. in the concrete.
  3. Joint devices associated with concrete work.
  4. Miscellaneous concrete elements, including, but not limited to: equipment pads, light pole bases, flagpole bases, thrust blocks, and manholes.
  5. Concrete curing.
  6. Coordination with other sections:
    - a. Make all preparations and do all work necessary to receive or adjoin other work. Install all bolts and anchors, including those furnished by other sections, into formwork and provide all required blocking.
    - b. Install all accessories embedded in the concrete and provide all holes, blockouts and similar provisions necessary for the work of other sections. Provide all patching or cutting made necessary by failure or delay in complying with this requirement at the Contractor's expense.
    - c. Coordinate with other sections for the accurate location of embedded accessories.
- B. Related Sections:
1. Pertinent Sections of Division 01 specifying Quality Control and Testing Laboratory services.
  2. Pertinent Sections of Division 03 specifying concrete construction.
  3. Pertinent Sections of other Divisions specifying work to be embedded in concrete or work penetrating concrete.
  4. Pertinent sections of other Divisions specifying floor finishes and sealants applied to concrete substrates.

##### 1.02 REFERENCES

- A. California Code of Regulations, Title 24, latest adopted edition (herein noted as CBC) Chapter 19A Concrete.
- B. American Concrete Institute (ACI) 211.1 "Standard Practice for Selecting Proportions for Normal, Heavyweight, and Mass Concrete"; ACI 211.2 "Standard Practice for Selecting Proportions for Lightweight Concrete".
- C. ACI 301 "Specifications for Structural Concrete".
- D. ACI 302.1R "Guide for Concrete Floor and Slab Construction".
- E. ACI 304R "Guide for Measuring, Mixing, Transporting, and Placing Concrete".

- F. ACI 305R "Hot Weather Concreting".
- G. ACI 306R "Cold Weather Concreting".
- H. ACI 308 "Standard Practice for Curing Concrete".
- I. ACI 318 "Building Code Requirements for Reinforced Concrete and Commentary".

### 1.03 SUBMITTALS

- A. Submit in accordance with pertinent sections of Division 01 specifying submittal procedures. The General Contractor shall review and approve shop drawings prior to submittal to the Architect/Engineer. Submittals that do not meet these requirements will be returned for correction without review. Submit for review prior to fabrication.
- B. Limitation of Review: Structural Engineer's review will be for general conformance with design intent as indicated in the Contract Documents and does not relieve Contractor of full responsibility for conformance with the Contract Documents.
- C. Product Data: Submit manufacturers' data on manufactured products and other concrete related materials such as bond breakers, cure/sealer, admixtures, etc. Demonstrate compliance with specified characteristics. Provide samples of items upon request. Submit material certificates for concrete aggregates and cementitious materials. Certificates shall show compliance to applicable ASTM's, the CBC, and additional requirements stated herein.
- D. Mix Designs: Submit Mix Designs for each structural concrete type required for work per requirements of articles CONCRETE MIXES and QUALITY ASSURANCE. Resubmit revised designs for review if original designs are adjusted or changed for any reason. Non-Structural mixes need not be submitted for review by Structural Engineer.
- E. Shop Drawings: Proposed location of construction and cold joints. Proposed location of all slab construction/dowel joints, control joints, and blockouts.
- F. Manufacturer's Installation Instructions: Indicate installation procedures and interface required with adjacent construction for concrete accessories.
- G. Batch Plant Certificates: Include with delivery of each load of concrete. Provide Certificates to the Testing Agency and the Architect/Engineer as separate submittals. Concrete delivered to the site without such certificate shall be rejected and returned to the plant. Each certificate shall include all information specified in Article SOURCE QUALITY CONTROL below.
- H. Engineering Analysis: Prepared by a California-licensed Civil or Structural Engineer, justifying construction-imposed loads on slabs, beams, and walls which exceed those allowed by CBC for the specified use.
  - 1. 2000 lbs maximum allowable construction load without analysis.
  - 2. 10,000 lbs maximum allowable construction load with analysis.
- I. Project Record Documents: Accurately record actual locations of embedded utilities and components that will be concealed from view upon completion of concrete work.



#### **1.04 QUALITY ASSURANCE**

- A. Perform work of this section in accordance with ACI 301 and ACI 318.
- B. Concrete construction verification and inspection to conform to CBC 1705A.3.
- C. Common Sourcing: Provide each of the following materials from a single source for entire project.
  - 1. Cement.
  - 2. Fly ash.
  - 3. Aggregate.
- D. Follow recommendations of ACI 305R when concreting during hot weather. Follow recommendations of ACI 306R when concreting during cold weather.
- E. Services by the Independent Testing Agency (includes "Special" Inspections) as specified in this Section and as follows:
  - 1. Perform tests and inspections specified below in articles SOURCE QUALITY CONTROL and FIELD QUALITY CONTROL. Duties and limitations of Independent Testing Agency, test costs and reports to be in conformance with pertinent Sections of Division 01.
- F. Contractor shall bear the entire cost of remediation, removal, and/or replacement of concrete determined defective or non-conforming, including Architect/Engineer fees for redesign.

#### **1.05 DELIVERY, STORAGE, AND HANDLING**

- A. Materials specified by brand name shall be delivered in unbroken packages bearing manufacturer's label and shall be brand specified or an approved equal.
- B. Delivery, Handling and Storage of other materials shall conform to the applicable sections of the current editions of the various reference standards listed in this Section.
- C. Protect materials from weather or other damage. Sort to prevent inclusion of foreign materials.
- D. Specific Requirements:
  - 1. Cement: Protect against dampness, contamination, and warehouse set. Store in weather tight enclosures.
  - 2. Aggregates: Prevent excessive segregation, or contamination with other materials or other sizes of aggregates. Use only one supply source for each aggregate stock pile.
  - 3. Admixtures:
    - a. Store to prevent contamination, evaporation, or damage.
    - b. Protect liquid admixtures from freezing and extreme temperature ranges.
    - c. Agitate emulsions prior to use.

#### **1.06 ENVIRONMENTAL REQUIREMENTS**

- A. Cold Weather (Freezing or near-freezing temperatures) per ACI 306R:

1. Heat concrete materials before mixing, as necessary to deposit concrete at a temperature of at least 50°F but not more than 90°F.
2. Do not place concrete during freezing, near-freezing weather, snow, rain or sleet unless protection from moisture and/or cold is provided.
3. Protect from freezing and maintain at a temperature of at least 50°F for not less than seven days after placing. Take special precautions to protect transit-mixed concrete.
4. No salts, chemical protection or admixture are permitted without written approval of Architect/Engineer.
5. Contractor shall maintain an air temperature log for the first 7 days after placement with entry intervals not to exceed 8 hours.

B. Hot Weather per ACI 305R:

1. Cool concrete materials before mixing, or add ice in lieu of mix water as necessary to deposit concrete at a temperature below 85°F.
2. Do not place concrete in hot/windy weather without Architect/ Engineer review of procedures.
3. Provide sunshades and/or wind breakers to protect flat work during finishing and immediate curing operations. Do not place flatwork concrete at air temperature exceeding 90°F.
4. Provide modified mix designs, adding retarders to improve initial set times and applying evaporation reducers during hot/windy weather for review by Independent Testing Agency prior to use.

**1.07 MOCK-UP**

- A. Construct and erect mock-up panel for architectural concrete surfaces indicated to receive special treatment or finish, as result of formwork.
  1. Panel Size: Sufficient to illustrate full range of treatment.
  2. Number of Panels: 2.
  3. Locate as indicated on drawings.
- B. If requested by Architect / Engineer, cast concrete against mock-up panel. Obtain acceptance of resulting surface finish prior to erecting formwork.
- C. Accepted mock-up panel is considered basis of quality for the finished work. Keep mock-up exposed to view for duration of concrete work.
- D. Mock-up may remain as part of the Work.

**1.08 SCHEDULING AND SEQUENCING**

- A. Organize the work and employ shop and field crew(s) of sufficient size to minimize inspections by the Testing Agency.
- B. Provide schedule and sequence information to Testing Agency in writing upon request. Update information as work progresses.

**PART 2 PRODUCTS**

## 2.01 FORMWORK

- A. Comply with requirements of Section 03 1000.

## 2.02 REINFORCEMENT

- A. Comply with requirements of Section 03 2000.

## 2.03 MATERIALS

- A. General Requirements: All materials shall be new and best of their class or kind. All materials found defective, unsuitable, or not as specified, will be condemned and promptly removed from the premises.
- B. Cementitious Materials:
  - 1. Portland Cement: ASTM C150, Type II, low alkali.
  - 2. Fly Ash (Pozzolan): ASTM C618, Class F.
- C. Concrete Aggregates:
  - 1. Coarse and Fine Aggregates: ASTM C33; Stone aggregate and sand. Specific source aggregate and/or sand or shrinkage characteristics as required for class of concrete specified.
  - 2. Source shall remain constant throughout the duration of the job. The exact portions of the fine aggregates and coarse aggregates to be used in the mix shall be determined by the mix design.
  - 3. Aggregates shall be tested for alkali reactivity per CBC section 1903A.5. Where test results exceed allowable limits, additional testing of mitigation procedures shall be provided, as outlined per CBC section 1903A.5.
- D. Water: Potable, clean, from domestic source.
- E. Admixtures: All admixtures shall be used in strict accordance with the manufacturer's recommendations. Admixtures containing calcium chlorides or other accelerators shall not be used without the approval of the Architect/Engineer and the Owner's Testing Laboratory.
  - 1. Mid Range Water Reducing Admixtures: ASTM C494 Type A, "MasterPolyHeed" (formerly "PolyHeed") series by BASF, "WRDA" series by W.R. Grace, or equal.
  - 2. High Range Water-Reducing Admixtures: ASTM C494 Type F, "MasterRheoBuild 1000" (formerly "RheoBuild 1000") or "MasterGlenium" (formerly "Glenium") series by BASF or equal.
  - 3. Water Reducing Admixture and Retarder: ASTM C494 Type B or D, "MasterPozzolith" (formerly "Pozzolith") series or "MasterSet DELVO" (formerly "DELVO") series by BASF, "Plastiflow-R" by Nox-crete, or equal.
  - 4. Air Entraining Admixtures: ASTM C260, product suit condition by BASF or equal.
  - 5. Viscosity Modifiers: ASTM C494 Type S.
- F. Slurry: Same proportion of cement to fine aggregates used in the regular concrete mix (i.e. only coarse aggregate omitted); well mixed with water to produce a thick consistency.

- G. High Strength Grout: See section 05 1100 for requirements.
- H. Dry Pack: Dry pack (used only for cosmetic concrete repairs) shall consist of:
  - 1. One part cement to 2-1/2 parts fine aggregate (screen out all materials retained on No.4 sieve), mixed with a minimum amount of water, added in small amounts.
  - 2. Mix to consistency such that a ball of the mixture compressed in the hand will retain its shape, showing finger marks, but without showing any surface water.

## 2.04 ACCESSORIES

- A. Bonding Agent: ASTM C881, Type II Grade 2 Class B or C. Do not allow epoxy to set before placing fresh concrete.
  - 1. "MasterEmaco ADH 326" (formerly "Concresive Liquid LPL") by BASF;
  - 2. "Rezi-Weld 1000" by W.R. Meadows.
- B. Chemical Hardener: Fluorosilicate solution designed for densification of cured concrete slabs. "MasterKure HD 300 WB" (formerly "Lapidolith") by BASF, "LIQUI-HARD" W.R. Meadows Co, or equal.
- C. Moisture-Retaining Cover: ASTM C171, type 1, one of the following:
  - 1. Regular Curing Paper, Type I, reinforced waterproof: Fortifiber Corporation "Orange Label Sisalkraft", "Pabcotite" paper, or equal.
  - 2. Polyethylene Film: ASTM D 2103, 4 mil thick, clear or white color.
  - 3. White-burlap-polyethylene sheet, weighing not less than 10 oz/per linear yd.
- D. Liquid Curing Compound: ASTM C 309, Type 1, Class B, clear or translucent, 25% minimum solids, water base acrylic cure/sealer which will not discolor concrete and compatible with bonding of finishes specified in related sections. W.R. Meadows Co. "Vocomp 25" or equal. Maximum VOC content shall comply with local requirements and California Green Building Code.
- E. Underslab Water Vapor Retarder: See Section 07 2500 "Weather Barriers".
- F. Evaporation Reducer: "MasterKure ER 50" (formerly Confilm), by BASF.
- G. Permeability Reducer: Use only where specifically referred to.
  - 1. Admixture Type: Xypex Chemical Corporation "XYPEX Admix C-500". Dosage: 2-3% of cement content by weight; 15 lb/cu. yd. max. or BASF "MasterLife 300D" (formerly "Rheomac 300D"). Dosage: 2% of cement content by mass.
  - 2. Surface-Applied Type: Xypex Chemical Corporation "XYPEX Concentrate. Brush application: 1.25-1.50lb/sq. yd., 5 parts powder to 2 parts water. BASF "MasterSeal 500" (formerly "Tegraproof"). Slurry coat: one part water to 2.25-2.5 parts powder by volume.
  - 3. Approved equal.

## 2.05 JOINT DEVICES AND MATERIALS

- A. Waterstops: Resilient type, meeting Corps of Engineers CRD-C 572. Consult manufacturer for appropriate product for specific use. Submit for review. Install per manufacturers recommendation. Provide W. R. Meadows "Seal Tight" PVC waterstop, Sika "Greenstreak" PVC waterstop, or approved equal.
- B. Expansion Joint Filler: ASTM D1751, Nonextruding, resilient asphalt impregnated fiberboard or felt, 3/8 inch thick and 4 inches deep; tongue and groove profile.
  - 1. Products: "Servicised Products", W.R. Meadows, Inc., "National Expansion Joint Company", "Celotex Corporation", or equal.
- C. Joint Filler: ASTM D944, Compressible asphalt mastic with felt facers, 1/4 inch thick and 4 inches deep.
- D. Sealant and Primer: As specified in Section 07 9200.
- E. Slab Joint Sealant: Compatible with floor finishes specified in related sections.

## 2.06 CONCRETE MIXES

- A. General requirements for mix design and submittal of structural class concrete:
  - 1. Provide Contractor submittals to Architect/Engineer not less than 15 days before placing concrete.
  - 2. Contractor shall review mix designs and proposed placing requirements prior to submittal for compatibility to ensure that the concrete as designed can be placed in accordance with the drawings and specifications.
  - 3. Changes or revisions require re-submittal: All variations to approved mix designs, including changing type and/or quantity of admixtures shall be resubmitted to the Architect/Engineer for review prior to use.
  - 4. Mix design(s) for all structural classes of concrete to be prepared by qualified person experienced in mix design. Allow for time necessary to do trial batch testing when required.
  - 5. Preparer to provide backup data and certify in writing that mix design meets:
    - a. Requirements of the specifications for concrete durability and quality;
    - b. Requirements of the California Building Code and ACI 318 Section 26.4, including break histories, trial batching test results, and/or a mix designed by a California Registered Civil Engineer per ACI 318 Section 26.4.3.1(b) and bearing the Engineer's seal & signature.
  - 6. Clearly note on mix designs with specified maximum WCR if design permits addition of water on site, or clearly identify in the mix design that no water is to be added on site.
  - 7. Deviations: Clearly indicate proposed deviations, and provide written explanation explaining how the deviating mix design(s) will provide equivalent or better concrete product(s) than those specified.
  - 8. Include adjustments to reviewed mix designs to account for weather conditions and similar factors.
- B. Proportioning - General: The following provisions apply to all mix designs:

1. Proportion concrete mixes to produce concrete of required average strength (as defined by ACI 318 Section 19.2.1). Select slump, aggregate sizes, shrinkage, and consistency that will allow thorough compaction without excessive puddling, spading, or vibration, and without permitting the materials to segregate, or allow free water to collect on the surface.
  2. Select aggregate size and type to produce dense, uniform concrete with low to moderate shrinkage, free from rock pockets, honeycomb and other irregularities.
  3. Mix designs may include water reducing and retarding admixtures to meet or exceed minimum set times (time required to place and finish) and to minimize Water Cement Ratios (WCR). Minimum and maximum criteria presented in this section are guidelines and do not represent a specific mix design.
  4. Cement Content: Minimum cement content indicates minimum sacks of cementitious material. Increasing cement content to increase early strengths or to achieve specified WCR while maintaining water content is discouraged in order to minimize effects of shrinkage.
    - a. Substitution of fly ash for Portland cement on an equivalent weight basis up to 25% replacement is permitted, except at high early strength concrete. Replacement in excess of 25% is not permitted unless part of a specified mix design that has been submitted for review.
    - b. Such substitution requests may be denied by the Engineer.
  5. Water Content: Mix designs with a specified maximum Water Cement Ratio (WCR) may be designed with a lower WCR than specified in order to allow addition of water at the site.
  6. Concrete Strength: Establish required average strength for each type of concrete on the basis of field experience or trial mixtures, as specified in ACI 301 and this section.
    - a. For trial mixtures method, employ independent testing agency acceptable to Architect/Engineer for preparing and reporting proposed mix designs.
  7. Placement Options: Mix designs may, at the Contractor's option, be designed for either pump or conventional placement with aggregate size, slumps, etc. to be maintained as specified in this section.
- C. Proportioning Normal Weight Concrete: Comply with ACI 211.1 recommendations and this section.
- D. Special mix design requirements for interior concrete floor slabs on grade:
1. Proportion concrete mixes per this specification, ACI 211.1, and the requirements below:
  2. Fly Ash Type F, shall be substituted for cement on a 1 lb. per 1 lb. basis, with a minimum replacement of 25% and a maximum of 35%.
  3. Preparer to provide backup data and certify in writing that mix design meets:
    - a. Requirements of the California Building Code and ACI 318 Section 26.4, including break histories and/or trial batching test results. Proportioning without field experience or trial mixtures is not permitted.
  4. Engineer from Laboratory of Record shall review mix design.
  5. 200 lbs. of 3/8(-) aggregate shall be added to reduce total sand.
  6. Reduce total sand to minimum practical.
  7. Admixture dosage shall be per manufacturer's recommendations. Dosage may be increased for workability as long as set times are not excessive for placement and finishing.

Mix Design Minimum Requirements:

Concrete Class	Coarse Aggregate Size (Inches) & Fine Aggregate <sup>3</sup>	Maximum WCR or Maximum Nominal Slump & Tolerance (Inches) <sup>1,2</sup>	Minimum 28-Day Design Strength	Minimum Cement Sacks/per yd <sup>4</sup>
<b>NON-STRUCTURAL</b>				
1) Lean Concrete (use only where specified)	---	---	---	3.0
2) Slab on Grade Exterior (Walks & Patios)	1" x #4	4" ± 1"	2,500	4.5
<b>STRUCTURAL</b>				
3) Interior Slab on Grade <sup>5</sup>	1" x #4	WCR = .45	3,000	6.1
4) Foundation	1" x #4	WCR = .53	3,000	5.0
5) Retaining Walls	1" x #4	WCR = .46	4,000	6.0
6) Drilled Pier	3/4" x #4	WCR = .53	3,000	5.0

1. The tolerance is the maximum deviation allowable without rejection. The mix design shall be based on the nominal value specified and is without water reducing mixtures. Slump to be measured at the end of the hose.
2. The maximum water cement ratio (WCR) is limited at time of placement as noted. No water is to be added on site such that the specified WCR or maximum slump is exceeded without approval of the testing laboratory and the Architect/Engineer. Workability is to be achieved utilizing an acceptable mid range to high range water reducing admixture.
3. Gradation of aggregate is per ACI 318 section 26.4.1.2 and ASTM C33.
4. Minimum cement content includes all cementitious materials.
5. See Article 2.06D for additional requirements at slabs on grade.

**2.07 MIXING CONCRETE**

- D. Batch final proportions in accordance with approved mix designs. All adjustments to approved proportions, for whatever reason, shall be reviewed by the Architect/Engineer prior to use.
- E. Batch and mix concrete in accordance with ASTM C94, at an established plant. Site mixed concrete will be rejected.
- F. Provide batch and transit equipment adequate for the work. Operate as necessary to provide concrete complying with specified requirements.

- G. Place mixed concrete in forms within 1-1/2 hours from the time of introduction of cement and water into mixer or 300 revolutions of the drum whichever comes first. Use of, re-mixing, and/or tempering mixed concrete older than 1 hour will not be permitted.
- H. Do not add water at the site to concrete mixes with a maximum specified WCR unless the water content at batch time provides for a WCR less than specified and this provision, including the quantity of water which may be added at the site, is specifically noted on the mix design and certification by the mix preparer. See ASTM C94 for additional requirements.

## 2.08 SOURCE QUALITY CONTROL

- D. Services by independent Testing Agency:
  - 1. Where aggregate alkali reactivity testing (and, when applicable, mitigation testing) per the MATERIALS section is not available, the Testing Agency shall perform this testing to verify materials conformance to CBC section 1903A.5.
  - 2. Batch Plant inspection at automated plants to occur at commencement of concrete work each day (first truck). Batch Plant inspection at non-automated plants and when accuracy is questionable shall be continuous. Additionally, water cement ratio (WCR) is to be verified where a WCR is specified herein. The computed WCR is to be written on the Batch Plant Certificate to be taken to the job site prior to the truck leaving the plant. See requirements of CBC 1705A.3.3.
  - 3. Batch Plant Certificates: Obtain the weighmaster's Batch Plant Certificate at arrival of truck at the site. If no batch plant certificate is provided, recommend to the General Contractor that the truckload of concrete be rejected. So note in daily log, along with the location of the load of concrete in the structure if the load is not rejected. See requirements of CBC 1705A.3.3.
    - a. Laboratory's inspector shall obtain for each transit mixer Batch Plant Certificates to verify mix design quantities and condition upon delivery to the site.
    - b. Certificates to include: Date, time, ingredient quantities, water added at plant and on job, total mixer revolutions at time of placement, and time of departure.
    - c. Concrete with specified water cement ratio: Add no water on site unless mix design and batch records each show additional water may be added. See ASTM C94 for additional requirements.

## PART 3 EXECUTION

### 3.01 EXAMINATION

- A. Verify lines, levels, and dimensions before proceeding with work of this section.
- B. Verify work of other sections is complete and tested as required before proceeding.

### 3.02 PREPARATION

- A. Observation, Inspection and Testing:
  - 1. Architect/Engineer: Notify not less than 2 working days before each concrete placement, for observation and review of reinforcing, forms, and other work prior to placement of concrete.



2. Testing Agency: Notify not less than 24 hours before each placement for inspection and testing.
- B. Placement Records: Contractor shall maintain records of time, temperature and date of concrete placement including mix design and location in the structure. Retain records until completion of the contract. Make available for review by Testing Agency and Architect/Engineer.
- C. Coordinate placement of joint devices with erection of concrete formwork and placement of form accessories.
- D. Verify location, position and inclusion of all embedded and concealed items.
- E. Verify installation of vapor retarder under interior slabs on grade, as specified in related section, is complete.
- F. Cleaning and Preparation:
  1. Remove loose dirt, mud, standing water, and foreign matter from excavations and cavities.
  2. Close cleanout and inspection ports securely.
  3. Thoroughly clean reinforcement and other embedded items free from loose rust and foreign matter. Maintain reinforcing securely in place. Do not place concrete on hot reinforcing.
  4. Dampen form materials and substrates on which concrete is to be placed at least 1 hour in advance of placing concrete; repeat wetting as necessary to keep surfaces damp. Do not saturate. Do not place concrete on saturated material.
    - a. Thoroughly wet wood forms (except coated plywood), bottom and sides of trenches, adjacent concrete or masonry and reinforcement.
    - b. Concrete slabs on base rock, dampen rock.
    - c. Concrete slabs on vapor retarder, do not wet vapor retarder.
  5. Verify that metal forms are clean and free of rust before applying release agent.
  6. Prepare previously placed concrete by cleaning with steel brush and applying bonding agent in accordance with manufacturer's instructions.
- G. Drill holes in existing concrete at locations where new concrete is doweled to existing work. Insert steel dowels and prepare connections as detailed.
- H. Do not overcut at existing concrete work to remain. Contractor is responsible for repair/replacement of overcut concrete to the Owner's satisfaction.

### **3.03 PIPES AND CONDUITS IN CONCRETE**

- A. Slabs-on-Grade:
  1. No pipe or conduit exceeding 1 inch outside diameter shall be embedded within the specified slab thickness except as specifically detailed.
  2. Do not stack or abut pipes, maintain 3 inches minimum clearance.
- B. Sleeving and Wrapping:
  1. Foundations: Sleeve or wrap all individual pipe penetrations, minimum 1-1/2 inches clear to reinforcing all around.

- a. Sleeves: PVC. Provide 1 inch minimum clear all around O.D. pipe to I.D sleeve, UNO at ends, fill void space with mastic or plastic bituminous cement.
  - b. Wrapped Vertical Pipes: Provide 1/8 inch nominal sheet foam with three wraps minimum, UNO.
  - c. Wrapped Horizontal Pipes: Provide 1/8 inch nominal sheet foam with eight wraps minimum, UNO.
  - d. Underground Fire Lines 4" and Larger: At sleeves provide 2 inch minimum clear all around O.D. pipe to I.D sleeve. At wrapped pipes, provide 1/8 inch nominal sheet foam with sixteen wraps minimum.
2. Slabs or Curbs: Wrap pipes as described above.
- C. Space groups of pipes/conduits at least 3 sleeve diameters apart, do not interrupt specified concrete and reinforcement.
1. Provide block-outs as detailed when grouping of pipes/conduits in foundation or other structural member prevents spacing as described. Notify Architect/Engineer for review of any conditions not conforming to details.
  2. Center pipe/conduit penetrations in the depth and/or thickness of foundations.
  3. Maximum size of pipe/conduit penetrations shall not exceed the least dimension of concrete divided by 3.

### 3.04 CONCRETE PLACEMENT

- A. Transporting:
1. Provide clean, well-maintained equipment of sufficient quantity and capacity to execute the work and produce concrete of quality specified.
  2. Handle and transport concrete from mixer to final deposit location as rapidly as practicable. Prevent separation or loss of ingredients.
- B. Perform concrete placement by methods which will not puncture, damage or disturb vapor retarder membrane. Repair all damage to vapor retarder membrane before covering.
- C. Placement - General: Placement, once started, shall be carried on as a continuous operation until section of approved size and shape is completed. Provide construction joints as detailed on the drawings. Engineer's written approval required for all deviations.
1. Deposition:
    - a. Deposit concrete to maintain an approximately horizontal plastic surface until the completion of the unit placement.
    - b. Deposit as neatly as practicable in final position, minimize re-handling or flow.
    - c. Do not drop concrete freely where reinforcing bars, embeds, or obstructions occur that may cause segregation. Provide spouts, elephant trunks, or other means to prevent segregation during placement.
  2. Depth: Layered placement in columns and walls shall not exceed ten feet vertical depth.
    - a. Place concrete in minimum 32 inch horizontal lifts.
    - b. Schedule placement to ensure that concrete will not take initial set before placement of next lift.
    - c. No horizontal cold joints are allowed in retaining walls.
  3. Progress Cleaning: Remove all concrete spilled on forms or reinforcing steel in portions of structure not immediately concreted. Remove completely before concrete sets.

4. Interruptions: Shut down placement operations and dispose of all remaining mixed concrete and concrete in hoppers or mixers following all interruption in placement longer than 60 minutes.
  - a. If such interruption occurs, provide new or relocate existing construction joints as directed by Engineer.
  - b. Cut concrete back to the designated line, cleaning forms and reinforcing as herein specified.
  - c. Prepare for resumption of placement as for new unit when reason for interruption is resolved.

D. Consolidation:

1. Consolidate all concrete thoroughly during placement with high-speed mechanical vibrators and other suitable tools. Perform manual spading and tamping to work around reinforcement, embedded fixtures, and into corners of formwork as required to obtain thorough compaction.
  - a. Provide vibrators with sufficient amplitude for adequate consolidation.
  - b. Use mechanical vibrators at each point of concrete placement.
  - c. Keep additional spare vibrators, in addition to those required for use, at the site for standby service in case of equipment failure.
2. Consolidate each layer of concrete as placed.
  - a. Insert vibrators vertically at points 18 to 30 inches apart; work into top area of previously placed layer to reconsolidate, slowly withdraw vibrator to surface.
  - b. Avoid contact of vibrator heads with formwork surfaces.
  - c. Systematically double back and reconsolidate wherever possible. Consolidate as required to provide concrete of maximum density with minimized honeycomb.

E. Unacceptable Materials:

1. Do not place concrete that has started to set or stiffen. Dispose of these materials.
2. Do not add water on site to concrete except as specified in the approved mix design, see PART 2 above.

F. Protection of installed work:

1. Do not introduce any foreign material into any specified drainage, piping or duct systems.
2. Contractor shall bear all costs of work required to repair or clean affected work as a result of failure to comply with this requirement.

### 3.05 CONCRETE JOINTS

A. Structural Joints (Construction/Cold Joints):

1. Locate joints only where shown, or as approved.
2. Review Required: Joints not indicated on the plans shall be located to meet the minimum requirements below, shall not impair the strength of the structure and shall be submitted to Architect/Engineer for review prior to placement of concrete.
  - a. Indicate proposed location(s) of construction/cold/expansion joints on shop drawing submittals for review prior to placing concrete.
3. Clean and roughen all surfaces of previously placed concrete at construction joints by washing and sandblasting to expose aggregate to 1/4 inch amplitude.

4. Slabs-On-Grade: Maximum Length of continuous placement shall not exceed 60 feet without special review by the Architect/Engineer. Alternate or stagger placement sections.
  5. Foundations: Maximum Length of continuous placement shall not exceed 200 foot increments. Provide “keyed” shut-off locations made up with form boards. Extend reinforcing one lap length or more through shut-off.
    - a. All reinforcement shall be continuous through construction/cold joint, lapping to adjacent reinforcing in future placement.
  6. Horizontal Construction Joints: Place 2 inch slurry (specified concrete mix less coarse aggregate) at beginning of pour at the bottom of walls unless a prior review of a mock-up section demonstrates that segregation of aggregate will not occur.
- B. Expansion/Construction Joints (Dowel Joints and Control Joints):
1. Interior and Exterior Floor Slabs-on-Grade:
    - a. Expansion/Construction Joints: Provide dowel joints or control joints at a maximum dimension (in feet) of three times the slab thickness (in inches) in each direction unless noted otherwise (15'-0" maximum). Install joints to match slab level and in straight lines. Locate joints at all reentrant corners including blockouts.
    - b. Proportions: Install joints to divide slab into rectangular areas with long dimensions less than 1.5 times short dimension.
  2. Exterior Concrete Paving (walkways, patios) and other non-structural concrete flatwork at grade:
    - a. Expansion/ construction joints: Provide a 2 inch deep troweled groove or asphalt impregnated joint material embedded 50 percent of the slab depth at 12 feet on center, maximum.
    - b. Proportions: Place no section with a length larger than two times width. Additionally, place joints at all inside corners and at all intersections with other work.
- C. Joint Types:
1. Dowel Joint: A keyed joint with smooth dowels passing through to allow unrestricted movement due to contraction and expansion. Joints are as specified on the drawings.
  2. Control Joint(s): Shrinkage crack control joints may be of the following types when shown on the drawings. Install joints in a straight line between end points with edges finished appropriate to type. Depth shall be 25% of the slab thickness, unless noted otherwise. Fill joints with sealant as shown on the drawings or as required by related sections.
    - a. 1/4 inch wide troweled joint.
    - b. Keyed joint: Only at locations where concealed by other finishes.
    - c. Masonite Strip, 1/8 inch: Only at locations where concealed by other finishes.
    - d. Saw Cut, 1/8 inch: Must be performed within eight hours of completion of finishing. Do not make saw cuts if aggregate separates from cement paste during cutting operation. Prevent marring of surface finish. Fill with flexible sealant.

### 3.06 VAPOR RETARDER

- A. Vapor Retarder Installation: Install as specified in Section 07 2500 “Weather Barriers”, ASTM E1643, and per manufacturer’s recommendations including taping and lapping of seams, sealing of penetrations, and repair of damage. Do not extend vapor retarder below footings.

### 3.07 FLATWORK

A. General Requirements for All Concrete Formed & Finished Flat:

1. Edge Forms and Screeds: Set accurately to produce indicated design elevations and contours in the finished surface, edge forms sufficiently strong to support screed type proposed.
2. Jointing: Located and detailed as indicated.
3. Consolidation: Concrete in slabs shall be thoroughly consolidated.

B. Flatwork Schedule:

1. Exterior Slabs-On-Grade: Place concrete directly over sub-base as indicated.
  - a. Sub-Base: Clean free-draining, crushed base rock, 6 inch minimum thickness, thoroughly compacted.
2. Interior Slabs-On-Grade:
  - a. Sub-Base: Clean free-draining, crushed base rock, 6 inch minimum thickness, thoroughly compacted.
  - b. Vapor Retarder: Install over sub-base.

**3.08 FORMED SURFACES**

- A. Form all concrete members level and plumb, except as specifically indicated. Comply with tolerances specified in ACI 318 Section 26.11, ACI 301 Section 2, and this specification, except that maximum permissible deviation is 1/4 inch end-to-end for any single member.

**3.09 CONCRETE FINISHES**

A. Flatwork Finishing:

1. All exposed concrete flatwork surfaces shall be non-slip. See Architectural, Civil, and Landscape drawings.
2. Perform with experienced operators.
3. Finish surfaces monolithically. Establish uniform slopes or level grades as indicated. Maintain full design thickness.
4. In areas with floor drains, maintain design floor elevation at walls; slope surfaces uniformly to drains as indicated on drawings.
5. Flatwork Finish Types:
  - a. Wood Float Finish: Surfaces to receive quarry tile, ceramic tile, or cementitious terrazzo with full bed setting system, or wood frame for raised finished floors.
  - b. Steel Trowel Finish: Surfaces to receive carpeting, resilient flooring, seamless flooring, thin set terrazzo, thin set tile or similar finishes specified in related sections. Trowel twice, minimum.
  - c. Broom Texture Finish: Exterior surfaces as indicated or for which no other finish is indicated. Finish as for steel trowel finish, except immediately following first troweling, (depending on conditions of concrete and nature of finish required) provide uniform surfaces texture using a medium or coarse fiber broom.

B. Other Concrete: Provide as required to achieve appearance indicated on structural and architectural drawings and related sections.

1. Repair surface defects, including tie holes, immediately after removing formwork.

2. Unexposed Form Finish: Rub down or chip off fins or other raised areas 1/4 inch or more in height.
3. Exposed Form Finish: Finish concrete to match forms. Rub down or chip off and smooth fins or other raised areas 1/4 inch or more in height. Provide finish as follows:
  - a. Smooth Rubbed Finish: Wet concrete and rub with carborundum brick or other abrasive, not more than 24 hours after form removal.
  - b. Grout Cleaned Finish: Wet areas to be cleaned and apply grout mixture by brush or spray; scrub immediately to remove excess grout. After drying, rub vigorously with clean burlap, and keep moist for 36 hours.
  - c. Cork Floated Finish: Immediately after form removal, apply grout with trowel or firm rubber float; compress grout with low-speed grinder, and apply final texture with cork float.
4. Intermediate joint and score marks and edges: Tool smooth and flush unless otherwise indicated or as directed by the Architect.
5. Use steel tools of standard patterns and as required to achieve details shown or specified. All exposed corners not specified to be chamfered shall have radiused edges.

### 3.10 TOLERANCES

- A. Minimum Flatwork Tolerances: Measure flatness of slabs within 48 hours after slab installation in accordance with ACI 302.1R and ASTM E1155 and to achieve the following FF and FL tolerances:
  1. Exterior surfaces: 1/8 inch minimum per foot where sloped to drain. Level otherwise. FF20 and FL15.
  2. Interior surfaces not otherwise shown or required: Level throughout. FF25 and FL20
  3. Interior surfaces required to be sloped for drainage: 1/8 inch in 10 ft.
  4. Finish concrete to achieve the following tolerances:
    - a. Under Glazed Tile on Setting Bed: FF30 and FL20.
    - b. Under Resilient Finishes: FF35 and FL25.
    - c. Flooring manufacturer and pertinent section of Division 9.
- B. Formed Surface Tolerances:
  1. Permanently Exposed Joints and Surfaces: Provide maximum differential height within two feet of, and across construction joints of 1/16 inch.
  2. Vertical Elevations: Elevation of surfaces shall be as shown or approved.

### 3.11 SEPARATE FLOOR TOPPINGS

- A. Prior to placing floor topping, roughen substrate concrete surface and remove deleterious material. Broom and vacuum clean.
- B. Place required dividers, edge strips, reinforcing, and other items to be cast in.
- C. Apply bonding agent to substrate in accordance with manufacturer's instructions.
- D. Apply sand and cement slurry coat on base course, immediately prior to placing toppings.
- E. Place concrete floor toppings to required lines and levels. Place topping in checkerboard panels not to exceed 20 feet in either direction.

- F. Screed toppings level, maintaining surface tolerances per above.

### 3.12 CONCRETE CURING

- A. Curing - General: Cure in accordance with ACI 308. Maintain concrete water content for proper hydration and minimize temperature variations. Begin curing immediately following finishing.
- B. Protection During Curing: Immediately after placement, protect concrete from premature drying, excessively hot or cold temperatures, and mechanical injury. The General Contractor is responsible for the protection of the finished slab from damage.
  - 1. Avoid foot traffic on concrete for minimum of 24-hours after placement.
  - 2. Protect concrete from sun and rain.
  - 3. Maintain concrete temperature at or above 50 degrees F. during the first 7 days after placement. See Article ENVIRONMENTAL REQUIREMENTS.
  - 4. Do not subject concrete to design loads until concrete is completely cured, and until concrete has attained its full specified 28-day compressive strength or until 21 days after placement, whichever is longer.
  - 5. Protect concrete during and after curing from damage during subsequent building construction operations. See Article PROTECTION.
- C. Maintain concrete with minimal moisture loss at relatively constant temperature for period necessary for hydration of cement and hardening of concrete.
  - 1. Normal concrete: Not less than 7 days.
- D. Begin curing immediately following finishing.
- E. Surfaces Not in Contact with Forms:
  - 1. Start initial curing as soon as free water has disappeared and before surface is dry. Keep continuously moist for not less than 3 days by water ponding, water-saturated sand, water-fog spray, or saturated burlap.
  - 2. Begin final curing after initial curing but before surface is dry.
    - a. Moisture-retaining cover: Seal in place with waterproof tape or adhesive.
    - b. Curing compound: Apply in two coats at right angles, using application rate recommended by manufacturer.
- F. Flatwork on Grade: Cure by one of the following methods:
  - 1. Water Cure (Ponding): Maintain 100 percent coverage of water over floor slab areas, continuously for minimum 7 calendar days.
  - 2. Spraying: Spray water over floor slab areas and maintain wet for 7 days.
  - 3. Moisture-Retaining Film or Paper: Lap strips not less than 6 inches and seal with waterproof tape or adhesive; extend beyond slab or paving perimeters minimum 6 inches and secure at edges; maintain in place for minimum 7 days.
  - 4. Absorptive Moisture-Retaining Covering: Saturate burlap-polyethylene and place burlap-side down over floor slab areas, lapping ends and sides and extend beyond slab or paving perimeters 6 inches minimum; maintain in place for minimum 7 days.

5. Liquid Membrane-forming Curing Compound: Provide only when subsequent concrete treatments or finish flooring specified in related sections will not be affected by cure/sealer. Apply curing compound in accordance with manufacturer's instructions at the maximum recommended application rate in two coats, with second coat applied at right angles to first.
- G. Formed Concrete Members: Cure by moist curing with forms in place for full curing period.
1. Protect free-standing elements from temperature extremes.
  2. Maintain forms tight for minimum 7 days. Maintain exposed surfaces continuously damp and completely covered by sheet materials thereafter.
  3. Maintain all shoring in place. Refer to related sections specifying formwork.
  4. Membrane Curing Compound: Apply compound in accordance with manufacturer's instructions in one coat.
- H. Foundations: Apply curing compound immediately after floating.

### **3.13 CONCRETE HARDENER**

- A. Apply hardener to all floor slabs not receiving other finishes after 30 days minimum curing. Clean slabs of non-compatible cure/sealers or other foreign material(s) and apply in strict accordance with the manufacturer's directions.

### **3.14 GROUTING AND DRY PACK**

- A. Set steel plates on concrete or masonry with high strength grout bed, completely fill all voids; thoroughly compact in place. See Section 05 1200 or 05 1100.
- B. Bolts or inserts dry packed or grouted in place shall cure for minimum 7 days before tensioning.

### **3.15 FIELD QUALITY CONTROL**

- A. Testing and Inspections by Independent Testing Agency: Provided verification and inspection of concrete per CBC Table 1705A.3. Provide written reports for to Engineer, Architect, Contractor and Building Official for the following tests and inspections:
- B. Testing & Inspection: Provide periodic inspection of reinforcing steel. Provide continuous inspection during placement of structural class concrete, 3000 psi or more. Non-structural class concrete with a design strength of 2500 psi or less to have periodic inspection on a 150 cubic yard basis as required to assure conformance.
  1. Provide periodic inspection of bolts in concrete prior to and during placement where so noted on the construction documents.
  2. Structural Concrete Cylinder Tests: Perform in accordance with ASTM C31.
    - a. Take four standard 6 inch x 12 inch (or five 4 inch x 8 inch) cylinder specimens on the site, of each class of concrete as specified in PART 2, not less than once a day or for each 50 cubic yards or 2000 sq ft or fraction thereof placed each day.
    - b. Record the location of each concrete batch in the building in a log and also note on each specimen.
    - c. Perform standard compression test of cylinders in accordance with ASTM C39, one at 7 days and two (three for 4x8 cylinders) at 28 days.



- d. Hold fourth (fifth) cylinder untested until specified concrete strengths are attained.
3. Structural Concrete Slump Test and Air Tests: Perform in accordance with ASTM D143 and C231 or C173 at the time of taking test cylinders, and/or at one-hour intervals during concrete placing.
4. Measure and record concrete temperature upon arrival of transit mixers and when taking specimens. Note weather conditions and temperature.
5. Propose adjustments to reviewed mix designs for Architect / Engineer review to account for variations in site or weather conditions, or other factors as appropriate.
6. Water Vapor Transmission Tests: Floors receiving floor finishes specified in related sections will be tested prior to installation of flooring systems. Refer to sections specifying floor finishes for related requirements.

C. Services by Contractor:

1. Rejection of Concrete Materials: Do not use the following without prior written approval of the Architect/Engineer;
  - a. Materials without batch plant certificates.
  - b. Materials not conforming to the requirements of these specifications.

### 3.16 ADJUSTING

- A. Inspect all concrete surfaces immediately upon formwork removal. Notify Architect/Engineer of identified minor defects. Repair all minor defects as directed.
- B. Surface and Finish Defects: Repair as directed by the Architect/Engineer, at no added expense to the Owner. Repairs include all necessary materials; reinforcement grouts, dry pack, admixtures, epoxy and aggregates to perform required repair.
  1. Repair minor defective surface defects by use of drypack and surface grinding. Specific written approval of Architect/Engineer is required. Submit proposed patching mixture and methods for approval prior to commencing work.
  2. Slabs-on-Grade, Elevated Slabs and on Slabs on Metal Deck: Review for "curled" slab edges and shrinkage cracks prior to installation of other floor finishes. Grind curled edges flush, fill cracks of 1/16 inch and greater with cementitious grout.
  3. Grind high spots, fins or protrusions caused by formwork; Fill-in pour joints, voids, rock pockets, tie holes and other void not impairing structural strength. Provide surfaces flush with surrounding concrete.

### 3.17 DEFECTIVE CONCRETE

- A. Defective Concrete: Concrete not conforming to required compressive strength, lines, details, dimensions, tolerances, finishes or specified requirements; as determined by the Architect/Engineer.
- B. Repair or replacement of defective concrete will be determined by the Architect/Engineer who may order additional testing and inspection at his option. The cost of additional testing shall be borne by Contractor when defective concrete is identified.
- C. Specific Defects:
  1. "Low-Strength"; Concrete Not Meeting Specified Compressive Strength after 28 days:

- a. Concrete with less than 25% Fly Ash as cementitious material: Test remaining cylinder(s) at 56 days. If strength requirements are met, concrete strength is acceptable.
- b. Concrete with 25% or more Fly Ash as cementitious material: Test remaining cylinder(s) at 70 days. If strength requirements are met, concrete strength is acceptable.
2. Excessive Shrinkage, Cracking, Cracking, Cracking or Curling; Defective Finish: Remove and replace if repair to acceptable condition is not feasible.
3. Lines, Details, Dimensions, Tolerances: Remove and replace if repair to acceptable condition is not feasible.
4. Slab sections not meeting specified tolerances for trueness/flatness or lines/levels: Remove and replace unless otherwise directed by the Architect/Engineer. Minimum area for removal: Fifteen square feet area unless directed otherwise by the Architect/Engineer.
5. Defective work affecting the strength of the structure or the appearance: Complete removal and replacement of defective concrete, as directed by the Architect/Engineer.

### **3.18 CLEANING**

- A. Maintain site free of debris and rubbish. Remove all materials and apparatus from the premises and streets at completion of work. Remove all drippings; leave the entire work clean and free of debris.
- B. Slabs to Receive Floor Finishes Specified in other sections: Remove non-compatible cure/sealers or other foreign material(s) which may affect bonding of subsequent finishes. Leave in condition to receive work of related sections.

### **3.19 PROTECTION**

- A. Protect completed work from damage until project is complete and accepted by Owner.
- B. Construction Loads: Submit engineering analysis for equipment loads (including all carried loads) specified in article submittals.
- C. Keep finished areas free from all equipment traffic for a minimum of 4 additional days following attainment of design strength and completion of curing.
- D. Protection of Drainage Systems:
  1. Care shall be taken not to introduce any foreign material into any specified drainage, piping or duct system.
  2. Cost of work to repair or clean drainage system as a result of failure to comply with this requirement will be back charged to the contractor.
- E. Cover traffic areas with plywood sheets or other protective devices; maintain protection in place and in good repair for as long as necessary to protect against damage by subsequent construction operations.

**END OF SECTION**

**SECTION 03 3511  
CONCRETE FLOOR FINISHES**

**PART 1 GENERAL**

**1.01 SECTION INCLUDES**

- A. Surface treatments for concrete floors and slabs.

**1.02 RELATED REQUIREMENTS**

- A. Section 01 6116 - Volatile Organic Compound (VOC) Content Restrictions.
- B. Section 07 9200 - Joint Sealers.
- C. Pertinent sections of Division 09 specifying concrete floor preparation for applied finishes.

**1.03 REFERENCE STANDARDS**

- A. ACI 301 - Specifications for Structural Concrete for Buildings; American Concrete Institute International; 2010.
- B. ACI 302.1R - Guide for Concrete Floor and Slab Construction; American Concrete Institute International; 2004 (errata 2007) .
- C. ASTM C39/C39M - Standard Test Method for Compressive Strength of Cylindrical Concrete Specimens; 2012a.
- D. ASTM C 309 - Standard Specification for Liquid Membrane-Forming Compounds for Curing Concrete; 1998a.
- E. ASTM C779 - Standard Test Method for Abrasion Resistance of Horizontal Concrete Surfaces.
- F. ASTM C805 - Standard Test Method for Rebound Number of Hardened Concrete.
- G. ASTM C1028 - Standard Test Method for Determining the Static Coefficient of Friction of Ceramic Tile and Other Like Surfaces by the Horizontal Dynamometer Pull-Meter Method.
- H. California Code of Regulations, Title 24, Part 11 California Green Building Standards Code, "CAL-Green" .

**1.04 ADMINISTRATIVE REQUIREMENTS**

- A. Coordinate the work with concrete floor placement and concrete floor curing.

**1.05 SUBMITTALS**

- A. See Section 01 3300 - Submittals, for submittal procedures.
- B. Product Data: Manufacturer's published data on each finishing product, including information on compatibility of different products and limitations.
- C. VOC Submittals: Product Data – VOC Limits: For adhesives, sealants, fillers and primers, documentation including printed statement of VOC contents, comply with limits specified in Section 01 6116.
- D. Maintenance Data: Provide data on maintenance and renewal of applied finishes.

**1.06 DELIVERY, STORAGE, AND HANDLING**

- A. Deliver materials in manufacturer's sealed packaging, including application instructions.

### 1.07 FIELD CONDITIONS

- A. Maintain light level equivalent to a minimum 200 W light source at 8 feet (2.5 m) above the floor surface over each 20 foot (6 m) square area of floor being finished.
- B. Do not finish floors until interior heating system is operational.
- C. Maintain ambient temperature of 50 degrees F (10 degrees C) minimum.

## PART 2 PRODUCTS

### 2.01 CONCRETE FLOOR FINISH APPLICATIONS

- A. Liquid Densifier/Hardener:
  - 1. Use at following locations: Locations indicated on the drawings.

### 2.02 DENSIFIERS AND HARDENERS

- A. Liquid Densifier/Hardener: Penetrating chemical compound that reacts with concrete, filling the pores and dustproofing; for application to concrete after set.
  - 1. Products:
    - a. Curecrete Distribution Inc.; Ashford Formula: [www.ashfordformula.com](http://www.ashfordformula.com).
    - b. Substitutions: See Section 01 6000 - Product Requirements.
  - 2. Performance Requirements:
    - a. Volatile Organic Content: 0 g/l.
    - b. Abrasion resistance (ASTM C779): At least 32.5% increase at 30 minutes.
    - c. Curing: At least 93% greater moisture retention during the initial critical 24 hour curing period compared to untreated samples.
    - d. Compressive strength (ASTM C39):
      - 1) At least 40% increase in compressive strength at 7 days compared to untreated samples.
      - 2) At least 38% increase at 28 days compared to untreated samples.
    - e. Impact resistance (ASTM C805): At least 13.3% increase in impact resistance compared to untreated samples.
    - f. Permeability 0.00073 oz (0.022 cc)/hour seepage rate using a 7'-0" (2.13 m) head of water and a 4.91 in<sup>2</sup> (3168 mm<sup>2</sup>) treated area.
    - g. Coefficient of Friction (ASTM C1028): 0.86 dry, 0.69 wet.

## PART 3 EXECUTION

### 3.01 EXAMINATION

- A. Verify that floor surfaces are acceptable to receive the work of this section.
- B. Verify that flaws in concrete have been patched and joints filled with methods and materials suitable for further finishes.

### 3.02 GENERAL

- A. Apply materials in accordance with manufacturer's instructions.

### 3.03 FLOOR SURFACE TREATMENT

- A. Verify that surface is free of previous coatings, sealers, curing compounds, water repellents, laitance, efflorescence, fats, oils, grease, wax, soluble salts, residues from cleaning agents, and other impediments to adhesion.
- B. Protect adjacent non-coated areas from drips, overflow, and overspray; immediately remove excess material.

- C. Apply products to scheduled floor surfaces in accordance with manufacturer's instructions.

**3.04 CLEANING AND PROTECTION**

- A. Protect completed work from damage until cured as described by manufacturer and ready for traffic.

**END OF SECTION**

**SECTION 03 3543**  
**POLISHED CONCRETE FINISHING**

**PART 1 GENERAL**

**1.01 SUMMARY**

- A. Section specifies Bonded Abrasive Polished Concrete Finishing for exposed interior concrete floor slabs including:
  - 1. Application of concrete sealer, hardener.
  - 2. Abrasive Polishing exposed concrete surfaces to finish level as indicated.
  - 3. Application of concrete dye.

**1.02 RELATED SECTIONS**

- A. Section 01 4000 - Mockup Requirements.
- B. Section 03 3000 - Cast-in-Place Concrete for formwork; material, fabrication, and installation requirements for steel reinforcement; and field quality control for concealed structural concrete.
- C. Section 03 3000 - Cast-in-Place Concrete: Finishing of concrete surface to tolerance; floating, troweling, and similar operations; curing.

**1.03 REFERENCES**

- A. American Society for Testing and Materials:
  - 1. ASTM-C94, Standard Specification for Ready-Mixed Concrete.
  - 2. ASTM-C779, Standard Test Method for Abrasion Resistance of Horizontal Concrete Surfaces.
  - 3. ASTM C805, Standard Test Method for Rebound Number of Hardened Concrete (Impact Strength).
  - 4. ASTM C1028, Standard Test Method for Determining the Static Coefficient of Friction of Ceramic Tile and Other Like Surfaces by the Horizontal Dynamometer Pull-Meter Method
  - 5. ASTM D16, Standard Terminology for Paint, Related Coatings, Materials, and Applications.
  - 6. ASTM D523, Standard Test Method for Specular Gloss.
  - 7. ASTM D1308, Standard Test Method for Effect of Household Chemicals on Clear and Pigmented Organic Finishes
  - 8. ASTM D5767, Standard Test Methods for Instrumental Measurement of Distinctness-of-Image Gloss of Coating Surfaces
- B. American Concrete Institute:
  - 1. ACI 302. 1R-89, Guide for Concrete Floor and Slab Construction.
- C. California Code of Regulations, Title 24, Part 11 California Green Building Standards Code, "CAL-Green".
- D. Concrete Polishing Association of America (CPAA); [www.concretepolishingassociation.com](http://www.concretepolishingassociation.com).

**1.04 DEFINITIONS**

- A. Terms as used in this section and as listed below shall have the meanings as defined by the Concrete Polishing Association of America (CPAA).

- B. Aggregate Exposure: Grinding a concrete floor surface with bonded abrasives to achieve a specified class of exposed aggregate. These are classified as A, B, C and D with varying levels of exposed aggregate (see Aggregate Exposure Chart).
- C. Bonded Abrasive Polished Concrete (BPAC): The multi-step operation of mechanically grinding, honing, and polishing a concrete floor surface with bonded abrasives to cut a concrete floor surface and to refine each cut to the maximum potential to achieve a specified level of finished gloss as defined by the CPAA. This yields the most durable finish and requires the least maintenance.
- D. Burnished Polished Concrete (BPC): The multi-step operation of mechanical friction-rubbing a concrete floor surface with or without waxes or resins to achieve a specified level of finished gloss as defined by the CPAA. This operation yields a less durable finish and requires more maintenance than bonded abrasive polished concrete.
- E. Distinction of Image (DOI): A measure of how clearly a reflective image will appear in a reflective surface.
- F. Dye: Non film forming soluble colorant dissolved in a carrier designed to penetrate and alter coloration and appearance of a concrete floor surface without a chemical reaction.
- G. Edge Detailing: The act of blending or installing a contrasting border along the perimeter of the room(s) using a liquid coating.
- H. Edge Polishing: The steps required by a polishing technician to process the concrete substrate along the perimeter of the room(s) to a finished gloss equal to that installed within the open areas of the room. These steps typically involve the same sequence of grits used by the polishing technician within the polishing process and typically are performed within sequence of the grinder.
- I. Finished Gloss: Processing a concrete floor surface to achieve a specified level of finished gloss prior to application of any protective treatment; Flat (ground), satin (honed), semi polished, and highly polished are measured in reflective clarity (DOI), and reflective sheen (specular gloss). Finished Gloss is classified as levels 1, 2, 3 and 4 with varying degrees of reflective clarity, and sheen. (see Finished Gloss Chart).
- J. Reflective Clarity: The DOI (distinction of image) value of the degree of sharpness and crispness of the reflection of overhead objects when measured by a device in accordance to ASTM D5767.
- K. Reflective Sheen: The specular gloss value of the degree of gloss reflected from a surface, at specified angles of illumination, when measured by a device in accordance to ASTM D523.
- L. Sealer (Definition from ASTM D16): A liquid composition to prevent excessive absorption of finishing coats into porous surfaces; also a composition to prevent bleeding.
- M. Specular Gloss: A single measurement of gloss by shining a known amount of light at a surface within a specified angle of illumination and quantifying the reflectance.
  - 1. Specified angles of illumination are 20 degrees for gloss ranges higher than 70 GU, 60 degrees for gloss ranges between 10-70 GU, and 85 Degrees for gloss ranges below 10 GU.
- N. Stain - Defect: A pronounced colored spot in the concrete caused by a material which is a soilant, discolorant or a reactant which changes the concrete surface resulting in an undesired appearance.

- O. Stain: Decorative Application Treatment: The deliberate action of applying a material to the concrete to change the color resulting in a transparent appearance by a chemical reaction, penetrating dye or pigment.
- P. Stain Resistant: As defined in ASTM D1308.
- Q. Static Coefficient of Friction (SCOF): The ratio of the horizontal component of force applied to a body that just overcomes the resistance to slipping to the vertical component of the weight of the object or force applied, measured in accordance with ASTM C1028.
- R. Surface Coated Concrete: Surface coated concrete does not conform to the definition of polished concrete per the CPAA. It is the operation of applying a film forming coating to a concrete floor surface to achieve a specified level of finished gloss. Durability depends on the quality of the chemical coating used, the amount of traffic across the floor, and floor maintenance.
- S. Surface Profile: The advanced measurement of surface topography on a microscopic level of a concrete floor surface with metrology devices.

#### 1.05 SUBMITTALS

- A. General: Submit in accordance with Section 01 3300-Submittal Procedures.
- B. Product Data:
  - 1. For each type of product indicated, demonstrate compliance with specified attributes.
  - 2. Manufacturer's recommended installation procedures.
  - 3. Provide descriptive data, curing time, and application requirements.
  - 4. Material Safety Data Sheet (MSDS) and other safety requirements.
- C. VOC Submittals: Product Data - VOC Limits: For adhesives, sealants, fillers and primers, documentation including printed statement of VOC contents, comply with limits specified in Section 01 6116.
- D. Test Reports:
  - 1. Provide certified test reports, prepared by an independent testing laboratory, confirming compliance with specified performance criteria.
- E. Samples: Submit 12 by 24 inch samples on each type of substrate indicated to receive polished finishes with specified coating applied at required rate to half of each sample.
  - 1. Manufacturer's samples are expected to demonstrate a smooth surface indicative of the gloss, but not the mix color or aggregate size, color or amount of aggregate exposed which may vary according to the concrete provided for the project.
  - 2. The final appearance of the finished surface cannot be guaranteed to match a sample due to the natural variations in concrete.

#### 1.06 QUALITY ASSURANCE

- A. Installer Qualifications:
  - 1. Certified by polished concrete finish manufacturer in writing stating that installer is certified applicator of polished concrete finishes, and is familiar with proper procedures and installation requirements required by the manufacturer and as specified in this section.
  - 2. Member of CPAA.
  - 3. Adequate availability of proper equipment to perform work shown on a timely basis.
  - 4. Successfully performed a minimum of 5 projects of at least 5000 square feet each.



- B. Pre-Installation Conference: Convene only after approval of complete submittals.
  - 1. Attendees: One representative of each entity directly concerned with cast-in-place concrete, including but not necessarily limited to the following persons: Contractors, Superintendent, Ready-Mix Concrete Producer, Concrete Sub-Contractor, Project Manager, Color Supplier and Architects.
  - 2. Agenda:
    - a. Subgrade Review, including compacted soil, vapor retarder, granular fill.
    - b. Concrete Review, including Mix Design, Quality Control, Delivery and Placement methods.
    - c. Environmental conditions, including ambient temperatures, material temperatures, light requirements.
    - d. Concrete Placement Schedules
    - e. Curing procedures
    - f. Protection of finished work during on-going construction.
    - g. Punch list of final concrete installation.
    - h. Architect to record decisions taken, items subject to review, and resolution of disagreements or conflicts.
- C. Mock-ups: Build mock-ups 10 feet x 10 feet or a minimum of 100 square feet in the location indicated or if not indicated, as directed by the Architect.
  - 1. Prepare mock-ups of each finish type, demonstrate typical joints, surface finish, color variation and other characteristics.
    - a. Notify Architect seven days in advance of dates and times when mock-ups will be constructed.
    - b. Demolish and remove mockups that do not meet requirements, as determined by the Architect. Prepare replacements until mock-ups are approved.
    - c. Maintain mock-ups during construction in an undisturbed condition as a standard for judging the completed work.
    - d. Obtain approval of mock-ups from the Architect prior to starting construction.
    - e. Approved mock-ups may become part of the completed work with Architect's approval.

#### **1.07 DELIVERY, STORAGE AND HANDLING**

- A. Deliver materials in original containers, with seals unbroken, bearing manufacturer labels indicating brand name and directions for storage.
- B. Dispense special concrete finish material from factory numbered and sealed containers. Maintain record of container numbers.

#### **1.08 PROJECT CONDITIONS**

- A. Ambient Conditions Limitations:
  - 1. Comply with manufacturer's written instructions for substrate temperature and moisture content, ambient temperature and humidity, ventilation, and other conditions affecting topping performance.
  - 2. Concrete must be cured a minimum of 28 days or as directed by the manufacturer before application can begin.
  - 3. Perform Polished Concrete Finishing only on unobstructed completed interior concrete slabs.
    - a. Schedule Polished Concrete Finishing minimum of ten (10) days prior to installation of equipment and substantial completion to permit unobstructed access to completed

concrete slab for application, curing and review of completed work before scheduling of subsequent activities.

- B. Close areas to traffic during surface application and after application, for time period recommended in writing by manufacturer.
- C. Protection: No satisfactory chemical or cleaning procedure is available to remove petroleum stains from the concrete surface. Prevention is essential.
  - 1. "Diaper" all hydraulic powered equipment to avoid staining of the concrete.
  - 2. Do not park vehicles on slabs scheduled to receive specified finish.
  - 3. Permit vehicle access only as long as necessary to complete required work, place drop cloths under vehicles to protect slabs at all times.
  - 4. Do not operate pipe cutting machine on slabs scheduled to receive specified finish.
  - 5. Do not place steel items on concrete to avoid rust staining.
  - 6. Use only equipment fitted with non-marking tires.
  - 7. Restrict use of acids or acidic detergents on slab.
- D. Provide disposal of slurry and finish by-products in compliance with all applicable codes.

## **PART 2 PRODUCTS**

### **2.01 PERFORMANCE REQUIREMENTS**

- A. VOC Limits for adhesives sealants, fillers, primers and coatings. Comply with limits specified in Section 01 6116.
- B. Bonded Abrasive Polished Concrete: Specific Floor Finishes required are listed in the SCHEDULE article at the end of the section.
  - 1. Provide specified Polished Concrete attributes (waterproofing, hardening, dust-proofing, sheen, and abrasion resistance) of the surface without changing the FL Levelness and FF flatness characteristics or natural appearance of the concrete, other than color (if specified).
  - 2. Aggregate Exposure:
    - a. Class A - Cream finish, very little surface cut, little aggregate exposure.
    - b. Class B - Fine Aggregate (Salt/Pepper Finish); 1/16 inch surface cut depth, Fine aggregate exposure with little or no medium aggregate exposure at random locations.
    - c. Class C - Medium Aggregate; 1/8 inch surface cut depth, Medium aggregate exposure with little or no large aggregate exposure at random locations.
    - d. Class D - Large Aggregate; 1/4 inch surface cut depth, Large aggregate exposure with little or no fine aggregate exposure at random locations..
  - 3. Finished Gloss Level:
    - a. Level 1 Flat (Ground); Reflective Clarity, Flat Appearance with no to very slightly diffused reflection; Reflective Sheen, none to very low; Grit Range below 100, suggested number of abrasive passes = 4.
    - b. Level 2 Satin (Honed); Reflective Clarity, Matte Appearance with or without slight diffused reflection; Reflective Sheen, low to medium; Grit Range 100-400, suggested number of abrasive passes = 5.
    - c. Level 3 Semi-Polished; Reflective Clarity, Objects reflected are not sharp and crisp but can be easily identified; Reflective Sheen, medium to high; Grit Range 800 and higher, suggested number of abrasive passes = 6.
    - d. Level 4 Highly-Polished; Reflective Clarity, Objects reflected are sharp and crisp seen in a mirror-like reflection; Reflective Sheen, high; Grit Range 800 and higher, suggested number of abrasive passes = 7.
- C. Slab Flatness / Levelness Requirements:

1. Polished Concrete shall have FL and FF values in accordance with Section 03 3513 "Concrete Finishing", but not less than;
  - a. Average Floor Flatness FF rating of at least 50, with a minimum of 35.
  - b. Average Floor Levelness FL rating of at least 50, with a minimum of 35.
- D. Performance Criteria:
  1. Abrasion Resistance: ASTM C779, Up to 400 percent increase in abrasion resistance.
  2. Impact Strength: ASTM C805, Up to 21 percent increase impact strength.
  3. Reflective Clarity: ASTM D5767, DOI (distinction of image) value up to 30 percent increase in reflectivity.
  4. Reflective Sheen: Values indicated above, measured per ASTM D523.
  5. Slip Resistance: Completed Polished Concrete shall have minimum Coefficient of Friction of 0.60 value, as measured in accordance with ASTM C1028
- E. Fly Ash:
  1. Comply with value specified in Section 03 3000 "Cast-In-Place Concrete" but no more than;
    - a. 20% of the weight of the Portland Cement should be substituted for with fly ash.
    - b. If fly ash is to be substituted, Class C is preferred.

## 2.02 POLISHED CONCRETE FINISHING PRODUCTS

- A. Manufacturers:
  1. FGS Permashine; L&M Construction Chemicals, [www.fgs-permashine.com](http://www.fgs-permashine.com).
  2. Retro-Plate 99; Advanced Floor Products, Inc., Provo, UT, tel: (888) 942-3144, web: [www.retroplatesystem.com](http://www.retroplatesystem.com) [www.retroplatesystem.com](http://www.retroplatesystem.com).
  3. Surelock Polished Concrete Color System; Ameripolish, [www.ameripolish.com](http://www.ameripolish.com).
  4. UltraFlor Architectural Polished Concrete Systems, [www.ultraflor.com](http://www.ultraflor.com).
  5. Substitutions: Section 01 6000.
- B. Source Limitations: Provide Polished Concrete Finishing Products and related materials from a single manufacturer.
- C. Polished Concrete Finishing Products: Available from a single manufacturer as a suite of related products and coatings formulated for compatibility and ability to produce finishes with specified characteristics.
  1. Hardener, Sealer, Densifier. Liquid applied, penetrating, manufacturers recommended type to harden and seal concrete for polishing. Sodium silicate or Lithium silicate formulations are acceptable.
  2. Joint Filler: Semi-rigid, 2-component, self-leveling, 100% solids, rapid curing, polyurea control joint and crack filler with Shore A 80 or higher hardness.
  3. Oil Repellent Sealer: Ready to use, silane, siloxane and fluoropolymers blended water based solution sealer, quick drying, low-odor, oil and water repellent, VOC compliant and compatible with chemically hardened floors.
  4. Concrete Dyes: Fast-drying dye, packaged in premeasured units ready for mixing with water or VOC exempt solvent; formulated for application to polished cementitious surfaces.
  5. Sealer: VOC compliant, topical sealer to effectively protect concrete and other natural stone floor surfaces from the damaging effects of staining, defacing and deterioration due to contaminant penetration.

## 2.03 RELATED MATERIALS

- A. Water: Potable, complying with ASTM C94 except free of wash water from mixer washout operations.

- B. Concrete Cleaning Solution: Biodegradable, VOC compliant, compatible with finishing products and recommended by Polished Concrete Finishing product manufacturer in writing.
- C. Concrete Repair Material: Compatible with finishing products and recommended by Polished Concrete Finishing product manufacturer in writing.
- D. Abrasives and Polishing Compounds: As required to produce abrasion and sheen effects specified in article PERFORMANCE REQUIREMENTS, compatible with finishing products and recommended by Polished Concrete Finishing product manufacturer in writing.
- E. Positive Protection: EZ Cover™ by McTech Corp, <http://mctechgroup.com>.
  - 1. Substitutions: Section 01 6000.

## **2.04 FINISHES**

- A. Color(s) as selected by Architect from:
  - 1. Manufacturer's full range of standard colors.
    - a. Provide minimum of 24 standard colors.
- B. Multiple color selections will be required as shown on the Drawings. If none are shown, request from the Architect.

## **PART 3 EXECUTION**

### **3.01 EXAMINATION**

- A. Examine substrate, with installer present, for conditions affecting performance of finish:
  - 1. Concrete must be in place a minimum of 28 days or minimum as directed by the Polished Concrete Finishing product manufacturer before application can begin.
  - 2. Verify that surfaces are free of construction laitance and other residue detrimental to Concrete Polishing
  - 3. Correct conditions detrimental to timely and proper work.
  - 4. Do not proceed until unsatisfactory conditions are corrected.
- B. Verify that base slab meets finish and surface profile requirements in:
  - 1. Section 03 3000 "Cast-In-Place Concrete,"
  - 2. Article PERFORMANCE REQUIREMENTS, above.

### **3.02 PREPARATION**

- A. Test unformed surfaces, such as floors and slabs, for finish and verify surface tolerances specified for each surface. Test surfaces sloped to drain for trueness of slope and smoothness; use a sloped template.
- B. Correct low and high areas using methods that will not affect concrete polished finishes. Refer to requirements for concrete repair in article titled REPAIR.

### **3.03 INSTALLATION**

- A. Floor Surface Polishing and Treatment:
  - 1. Do not begin the surface finish applications until Polished Concrete Finishing product manufacturer's technical representative is present.
  - 2. Provide unobstructed access to concrete slab for application activity.
  - 3. Fill joints flush to surface prior to the start of polish operations.
  - 4. Provide polished concrete floor treatment in entirety of slab indicated by drawings. Provide consistent finish in all contiguous areas.
  - 5. Apply floor finish prior to installation of fixtures and accessories.

6. Diamond polish concrete floor surfaces with power disc machine recommended by floor finish manufacturer. Sequence with coarse to fine grit. Installer to determine the optimum starting grit in order to achieve the specified aggregate exposure.
  - a. Comply with manufacturer's recommended polishing grits for each sequence to achieve specified finish level. Following the initial passes of metal bond diamonds, the installer shall drop back a minimum of one grit level when transitioning to resin bond diamonds. The separation in grit designation shall be a minimum of 50 for the transitioning step. The installer shall refine each abrasive grit to its fullest potential before moving on to the next level.
  - b. Scrub floor thoroughly between each grit pass, remove all loose material. Level of sheen shall match that of approved mock-up.
  - c. Expose aggregate in concrete surface only as determined by approved mock-up.
  - d. Polish until all concrete surfaces are uniform in appearance.
7. Dyed and Polished Concrete :
  - a. Locate demarcation line between dyed surfaces and other finishes.
  - b. Polish concrete to the grit level recommended by manufacturer for colors and dye types selected, to match appearance of approved mockup.
  - c. Apply pre-mixed dyes to polished concrete surface.
  - d. Allow dye to dry.
  - e. Remove residue with water and buffer pad; reapply as necessary for desired result and to match approved mockups.
8. Hardener, Sealer, Densifier: Minimum two coats at Polished Concrete Finishing product manufacturer's recommended rates.
  - a. First coat, following the 400 grit level.
  - b. Second coat prior to the final polishing pass.
  - c. Follow manufacturer's recommendations for drying time between successive coats.
9. Re-polish defective areas before demobilizing equipment. Remove defects, provide finishes matching approved mockups.
10. Provide clean and sharply defined edges of floor finish between different colors, within patterns, and where adjoining other materials.

### 3.04 ADJUSTING

- A. Repair and cure defective finished surfaces of polished concrete only when approved by Architect. Match repairs to color, texture, and uniformity of surrounding surfaces and to repairs on approved mockups.
- B. Remove and replace polished concrete that cannot be repaired and cured to Architect's approval.
  1. Remove to the nearest full construction joint (not saw-cut) in each direction.
- C. Contractor shall propose repair methods for Architect's approval, and perform proposed repair testing on approved mockups before repairing permanent work.
  1. Patch a test area on approved mockup location(s) to verify mixture and color match before proceeding with patching.
  2. Obtain Architect's written approval of repair method before commencing permanent repair.
  3. Revise rejected repair methods and re-submit, or at Architect's option, replace defective concrete.
- D. Defective Concrete: The following are considered defective work subject to repair or replacement;
  1. Surfaces not meeting requirements of this section.

2. Surfaces not matching approved mockups.
  3. Spalls, popouts, honeycombs, air bubbles, rock pockets, crazing and cracks in excess of 0.01 inch (0.25 mm) wide or that penetrate to reinforcement or completely through unreinforced sections regardless of width, whether from installation activities, defective installation or construction traffic.
  4. Color and texture irregularities, stain defects as defined in this section, tire tracks, tool marks and other objectionable discolorations that cannot be removed by cleaning.
  5. Test surfaces, such as floors and slabs, for finish and verify surface tolerances specified for each surface. Correct low and high areas. Test surfaces sloped to drain for trueness of slope and smoothness; use a sloped template.
- E. Repairing Polished Concrete Surfaces: Repair finished surfaces containing defects.
1. Cutting out and refilling is not permitted on Polished Concrete surfaces. Remove entire panel from expansion joint to expansion joint. Do not add sawcut joints for removal.
  2. Utilize only repair methods and materials that have proved to provide satisfactory results on mockup repair and that are approved by the Architect in writing.
  3. Remove Polished Concrete Surfaces that does not match approved mockups or otherwise defective as defined in this section, and replace with new work.
  4. Repair high spots by grinding, without affecting continuity of surface finish.
- F. Perform structural repairs of concrete, subject to Architect's approval, using epoxy adhesive and patching mortar.
- G. Repair materials and installation not specified above may be used, subject to Architect's approval.

### **3.05 CORRECTION OF DEFECTIVE WORK**

- A. Correction of defective work shall be the responsibility of the Contractor.
- B. Work not in compliance with the requirements of the Contract Documents and approved mockups shall be considered defective, unless otherwise directed in writing by the Architect.
- C. Corrected work shall conform to the requirements of the Contract Documents.
- D. The Contractor shall prepare a submittal documenting the defective work and proposed corrections and submit to the Architect for review. The submittal shall include a description of the defective work, the location of defective work, and shall be accompanied by supporting sketches, photographs, or both. Additionally, the submittal shall include similar documentation of the Contractor's proposed corrections.
- E. Demonstrate proposed corrections on site mockups. If mockups do not exist with similar defects, replace the defective work, do not repair or correct.
1. Correction of defective work shall not commence until the Architect has reviewed and accepted the proposed correction methods as demonstrated on mockups.
  2. Correction of defective work, if approved shall be inspected by the Owner's Testing Agency.
- F. If, after review of proposed corrections on site mockups, the Architect determines that proposed corrective methods will not provide Polished Concrete finishes meeting the requirements of the Contract Documents, Contractor shall remove the defective work and replace with new concrete meeting the specified standards at no added cost.

### **3.06 PROTECTION AND CLEANING**

- A. The premises shall be kept clean and free of debris at all times.

- B. Remove spatter from adjoining surfaces and repair damages to surface caused by cleaning operations.
- C. Remove debris from jobsite
  - 1. Dispose of materials in separate, closed containers, and in accordance with local regulations.
- D. Protect finished work until fully cured in accordance with manufacturer's recommendations.
- E. Provide positive protection until final completion of project. Conventional tarpaulins or plywood panels are not acceptable.
- F. Do not permit traffic or overhead work over unprotected surfaces.

### 3.07 SCHEDULE

- A. Polished Concrete Floor (PC-1): Bonded Abrasive Polished Concrete.
  - 1. Aggregate Exposure: Class C, "Medium Aggregate".
  - 2. Finished Gloss: Level 3, "Semi-Polished".
  - 3. Color as selected by Architect, (allow for minimum of three).
  - 4. Pattern, as indicated on Drawings, if no pattern is indicated, request from Architect prior to layout.

**END OF SECTION**

## SECTION 04 2000

### CONCRETE UNIT MASONRY

#### PART 1 GENERAL

##### 1.01 SUMMARY

- A. Section Includes: All labor, material and equipment and perform all operations required to complete all masonry work as indicated on the drawings and specified.
- B. Additional work included in this section: Provision of concrete grout and installation of items provided by other trades that are embedded in and/or attached to masonry work; providing forms at block-outs and formed concrete grout.
- C. Related Sections:
  - 1. Pertinent Sections of Division 01 specifying Quality Control and Testing Agency services.
  - 2. Pertinent sections of other Divisions specifying formwork, reinforcement, concrete, masonry, steel, and rough carpentry.
  - 3. Pertinent Sections of other Divisions specifying work to be embedded in concrete or work penetrating concrete work.

##### 1.02 REFERENCES AND STANDARDS

- A. California Code of Regulations, Title 24, latest adopted edition (herein noted as CBC): Chapter 19A Concrete, Chapter 21A Masonry
- B. TMS 402 / ACI 530 / ASCE 5 "Building Code Requirements for Masonry Structures".
- C. TMS 602 / ACI 530.1 / ASCE 6 "Specification for Masonry Structures".
- D. ASTM A615 "Deformed and Plain Carbon-Steel Bars for Concrete Reinforcement".
- E. ASTM C90 "Load-Bearing Concrete Masonry Units".
- F. ASTM C144 "Aggregate for Masonry Mortar".
- G. ASTM C270 "Mortar for Unit Masonry".
- H. ASTM C404 "Aggregates for Masonry Grout".
- I. ASTM C476 "Grout for Masonry".

##### 1.03 SUBMITTALS

- A. Submit in accordance with Division 01 specifying submittal procedures. The General Contractor shall review and approve submittals prior to submittal to the Architect/Engineer. Submittals that do not meet these requirements will be returned for correction without review.



- B. Limitation of Review: Structural Engineer's review will be for general conformance with design intent as indicated in the Contract Documents and does not relieve Contractor of full responsibility for conformance with the Contract Documents.
- C. Product Data: Submit manufacturer's product data, specifications, location and installation instructions for proprietary materials and reinforcement accessories. Provide samples of these items upon request.
- D. Contractor Submittals:
  - 1. Mix design for all grout and mortar, prepared by a qualified testing laboratory, per TMS 602 section 1.5. Show conformance of mix to proportion specification of ASTM C270 for mortar and ASTM C476 for grout. Alternatively, provide test results and show conformance of mix to property specification of ASTM C270 for mortar and ASTM C476 for grout. Mix shall conform to all requirements herein.
  - 2. Material certificates for all materials used in mixes.
  - 3. Submit shop drawings for all shapes and sizes of concrete unit masonry shown and scheduled on the drawings. Submit shop drawings detailing and locating all masonry reinforcement.
  - 4. Certificate of compliance and test data by concrete unit masonry supplier showing conformance to specified material strengths and properties.
  - 5. Samples: Laid up sections of masonry walls for the Architect's approval of size, texture and color of block, mortar and joint pattern.
  - 6. Layout of vertical control joints in masonry walls coordinated with structural and architectural drawings.
  - 7. Submit cold and/or hot weather construction procedures when ambient temperature is below 40°F or above 90°F. See PART 3.

#### 1.04 QUALITY ASSURANCE

- A. For requirements of the Authority Having Jurisdiction, refer to pertinent sections of Division 01 and CBC Chapter 17A.
- B. All tests shall be performed by an approved Testing Agency as specified in pertinent sections of Division 01.
- C. Testing and Inspection: Tests and inspections performed by approved Testing Agency are specified below in Articles SOURCE QUALITY CONTROL and FIELD QUALITY CONTROL and the Testing & Inspection Form. Duties and limitations of approved Testing Agency, test costs and test reports in conformance with pertinent sections of Division 01.
- D. General: Provide reports to Architect/Engineer and Authorities Having Jurisdiction (AHJ) indicating results of tests and inspections.
- E. Concrete Unit Masonry
  - 1. All testing of concrete unit masonry by the approved Testing Agency shall comply with the requirements of CBC Chapters 17A and 21A.
  - 2. Approved Testing Agency shall provide Level C Quality Assurance Program per TMS 602 and CBC Chapter 17A by an approved inspector of masonry construction.

- F. Contractor shall provide adequate materials for sampling and shall patch core holes made by the approved Testing Agency using non-shrink, high- strength grout.

#### **1.05 PRODUCT DELIVERY, STORAGE AND HANDLING**

- A. Deliver and store packaged material in original containers with seals unbroken and labels intact until time of use.
- B. Unload masonry units carefully and store on raised platform protected from weather.
- C. Protect cementitious materials against exposure to moisture. Use of cementitious or other materials that have become caked and hardened from absorption of moisture will not be permitted.

#### **1.06 JOB CONDITIONS**

- A. Environmental Conditions: Do not place concrete unit masonry when temperature is below 40 degrees Fahrenheit or above 90 degrees Fahrenheit unless the Contractor provides means for preventing damage due to freezing or high-temperatures before and after placement and the Architect/Engineer approves. See Section PART 3.
- B. Protection: Protect surrounding work as required against damage from masonry work. Clean satisfactorily or otherwise correct damage to surrounding work resulting from masonry work. See PART 3.

#### **1.07 SCHEDULING AND SEQUENCING**

- A. Organize the work and employ shop and field crew(s) of sufficient size to minimize inspections by the approved Testing Agency.
- B. Provide schedule and sequence information to approved Testing Agency in writing upon request. Update information as work progresses.

### **PART 2 PRODUCTS**

#### **2.01 MATERIALS**

- A. Hollow Load-Bearing Concrete Masonry Units:
  - 1. General: All concrete masonry units shall be double open end wherever possible (single open end otherwise).
  - 2. Concrete masonry units shall be medium or light weight and shall conform to ASTM C90. Minimum compressive strength shall be 2000psi.
  - 3. Concrete masonry units exposed to view shall be 8x8x16 unless otherwise noted on the construction drawings. Concrete masonry caps shall be 2x8x16 (nominal) standard grey unless otherwise noted on the construction drawings.
- B. Portland Cement: ASTM C150, Type II, low alkali
- C. Aggregates
  - 1. For Mortar: ASTM C144.

2. For Grout: ASTM C404.
- D. Hydrated Lime: ASTM C207, Type S
- E. Quick Lime: ASTM C5, high calcium
- F. Reinforcing Steel: ASTM A615 (or A706) grade 60 (except bars #3 and smaller may be grade 40).
- G. Water: Clean and potable, free from impurities detrimental to mortar and grout.
- H. Grout Aid: "Grout Aid" by Sika Corporation.
- I. High Strength Grout: Conform to CRD-C621 and ASTM C1107. Non-shrink, non-ferrous, minimum compressive strength at 28 days to be 7000 psi (when placed in a fluid state). Meet or exceed BASF "Master Flow 928".
- J. Pre-molded Control Joint: ASTM D2000 M2AA-805 rubber shear keys with a minimum durometer hardness of 80 or ASTM D2287 Type PVC 654-4 PVC shear keys with a minimum durometer hardness of 85.
- K. Flexible Sealant: ASTM C920.
- L. Mortar Color: Submit to Architect for approval.

## 2.02 FABRICATION

- A. Reinforcement: Conform to requirements of Section 03 2000, Concrete Reinforcing.

## 2.03 MIXES AND MIXING

- A. General Mixing Requirements:
  1. Measure materials accurately. Shovel measurements will not be permitted.
  2. Use mechanical mixer of at least one sack capacity.
  3. Mix for minimum of three minutes and in no case less than time required for securing uniform mass and workable consistency.
  4. Completely empty drum before charging succeeding batch of materials.
  5. Exercise extreme care in measuring ingredients for partial batches.
  6. Air entraining admixtures are not permitted.
- B. Mortar
  1. Type M or S per ASTM C270. Minimum compressive strength at 28 days: 1800 psi (Type S), 2500 psi (Type M). Admixtures not allowed. Otherwise conform to CBC Section 2103A.2.1.
  2. Use and place mortar in final position within 2-1/2 hours after mixing. Mortars that have stiffened due to evaporation of water may be retempered with water as frequently as required to restore required consistency during this time period.
  3. Provide integrally colored mortar to match block. Colors to be submitted to Architect for approval. Add mortar colors in accordance with manufacturer's recommendations. Ensure uniformity of mix and coloration.

C. Concrete Grout

1. General:
  - a. Six sacks (94 pounds per sack) of cement per cubic yard minimum. Concrete masonry grout compressive strength to attain 2000 psi minimum after 28 days
  - b. One pound "Sika Grout Aid" per sack of cement (6 pounds maximum per cubic yard).
  - c. Slump: 10 to 11 inches.
  - d. Grout shall be coarse.
2. Otherwise conform to CBC Section 2103A.3.

**2.04 SOURCE QUALITY CONTROL**

- A. An approved Testing Agency will perform source quality control tests and submit reports, as specified in pertinent section of Division 01 and CBC Chapter 17A and 21A.
- B. Test materials per CBC Chapter 17A and CBC Section 2105A.1 unit strength method or prism test method.

**PART 3 EXECUTION**

**3.01 INSPECTION BY CONTRACTOR**

- A. Examine areas to receive masonry and verify following per TMS 602:
  1. Foundation surface is level to permit bed joint within range of 1/4 to 3/4-inch.
  2. Edge is true to line to permit projection of masonry to less than 1/4-inch.
  3. Projecting dowels are free from loose scale, dirt, concrete or other bond-inhibiting substances and properly located.
  4. Built-in items are properly sized and located.
- B. Do not begin work before unsatisfactory conditions have been corrected.

**3.02 PREPARATION**

- A. Clean concrete surfaces to receive masonry. Remove laitance or other foreign material lodged in surface by sandblasting or other means as required. Roughen foundation bed to expose aggregate; remove loose particles and saturate before laying units.
- B. Ensure masonry units are clean and free from dust, dirt or other foreign materials before laying.

**3.03 REINFORCEMENT**

- A. Place bars where noted in accordance with drawings and SP-66 "ACI Detailing Manual". Do not disturb after start of masonry placement.
- B. Splice bars with dowels cast in concrete; lap bars per drawings. Bars shall not be "stabbed" after grout placement. All reinforcing shall be tied in place with wire prior to grout placement. The use of approved bar spacers is acceptable.

**3.04 PLACEMENT**

A. General Requirements

1. Masonry construction shall conform with TMS 602 as modified by CBC Chapter 21A.
2. Ensure masonry units are sound, clean and free of cracking at time of placement.
3. Accurately cut and fit units as required using masonry saws to accommodate work of other sections.
4. Lay masonry units plumb, true to line with level courses accurately placed. Maximum tolerance 1/4" in 8'-0".
5. Adjust unit to final position while mortar is soft and plastic.
6. Align vertical cells accurately.
7. Remove units disturbed after stiffening of mortar, clean joints and relay unit with fresh mortar.
8. Do not attach construction supports to walls.
9. Install anchor bolts and other embedded items accurately as work progresses. Use templates as necessary to meet required tolerance of other's work.
10. Brace walls adequately until supporting structure is complete.
11. Do not place conduit, pipes, wire, etc. in cells containing reinforcing steel.

B. Joints:

1. Fill joints; ensure full coverage of face shells in both horizontal and vertical joints and on webs.
2. Tool (concave) and finish joints as specified to achieve solid, smooth, watertight compacted joint.
3. Immediately fill holes made by line pin with mortar when pin is withdrawn.
4. Remove surplus mortar from joints.
5. Provide vertical control joints at 1.5 times the wall height (but not greater than 25'-0") and as detailed on the structural drawings.

C. Cold Weather Requirements

1. When ambient temperature is below 40 degrees Fahrenheit, submit cold weather protection plan per TMS 602 Section 1.8C. Ensure reinforcing, masonry units, etc. contacting mortar and grout are free of frost.

D. Hot Weather Requirements

1. When ambient temperature exceeds 90 degrees, submit hot weather protection plan per TMS 602 Section 1.8D.

E. Protection

1. Protect face materials against staining.
2. Remove misplaced grout or mortar immediately.
3. Protect sills, ledges, off-sets and similar items from mortar drippings or other damage during construction.
4. Cover top of unfinished work to protect it from weather and debris.

F. Concrete Masonry Units

1. Bond: Running bond unless specifically noted otherwise.
2. Joint Thickness: 3/8-inch both vertically and horizontally.

3. Joint Treatment:
  - a. Typical exterior and interior walls; tool joint for weather tightness.
  - b. Construction joints to be sealed with joint sealant or high strength grout as noted on the drawings.
4. Use proper units to provide for doors, bond beams lintels, etc. in order to minimize cutting.
5. Do not wet units.
6. Align vertical cells to provide continuous, unobstructed opening for grouting.
7. Corners: Provide standard masonry bond by overlapping units.
8. Provide mechanical cleanout methods as needed. To facilitate cleanout were pour height exceeds 48 inches, provide inverted bond beam units at the bottom of each pour and provide cleanouts in these courses as necessary, not exceeding 32 inches on center. Provide cleanout at each vertically-reinforced cell. Locate cleanouts to minimize visual impact. Verify with Architect/Engineer.

### 3.05 GROUTING

#### A. General Requirements

1. Conform to requirements of TMS 602 as modified by CBC Chapter 21A.
2. A pour is defined as the height of grout to be placed in one day. The height of masonry unit placement at the time of grouting shall not exceed the pour height. Masonry shall have cured minimum 4 hours before grout placement. Maximum pour height is 12 feet, or less, as determined by the contractor. Maximum individual lift height is 48 inches, or less, as determined by the contractor. Allow time between lifts for initial water loss of grout to occur. Do not allow grout to cure between lifts. Contractor is responsible for adequate cleaning and prevention of blowouts.
3. Grout void between wythes and cells of concrete block.
4. Ensure grout flows into voids and completely surrounds reinforcing steel.
5. Stop grout approximately one and a half inches below top of last course except at top course without a concrete cap.
6. Grout from a non-exposed face of masonry wherever possible.
7. Where necessary to stop longitudinal run, provide suitable dam to retain grout in place.
8. Clean all cells of pour space prior to grouting. Remove all loose mortar, etc.
9. Consolidate grout with a mechanical vibrator with a 3/4" head.
10. Slushing with mortar will not be permitted.
11. Use grout pump, hopper or bucket to place grout.
12. Do not wet down grout spaces prior to grouting.
13. Otherwise conform to CBC Section 2104A.1.3.1.

### 3.06 FIELD QUALITY CONTROL

- A. The approved Testing Agency will perform field quality control tests, as specified in pertinent sections of Division 01 and CBC Chapters 17A and 21A.
- B. The approved Testing Agency will provide inspections per the requirements of CBC Section 1705A.4.
- C. Concrete masonry shall have an assumed 28 day prism strength of 2000psi.
- D. Core test installed masonry per CBC Section 2105A.4.

### 3.07 POINTING AND CLEANING

- A. Point holes or defective mortar joints upon completion of work; where necessary, cut out and repoint defective joints.
- B. At end of workday, fiber brush new surfaces to remove mortar splotches, clean with mild detergent or enzymes, and rinse with clean water.
- C. When ordinary methods are not adequate, employ sandblasting, chipping or other special methods.
- D. Do not use acid solution to remove green stain or efflorescence resulting from vanadium salts. Follow recommendations of manufacturer for removal of such stains.
- E. Clean all surfaces upon completion of erection; leave free of grime and dirt. Remove unused materials, tools, equipment and debris from the premises and leave surfaces broomed clean.
- F. Protect work from damage by subsequent operations.

### **3.08 ADJUSTING**

- A. Replace all defective work at Contractor's expense.
- B. Replace defective or damaged work with conforming work.
- C. Architect/Engineer shall review all proposals for the repair or replacement of damaged, defective, or missing work.
- D. Contractor to pay expenses incurred by Owner for Architect/Engineer's costs for (re-) design and obtaining approvals of Authorities Having Jurisdiction necessitated by incomplete, inefficiently scheduled, improperly performed, defective or nonconforming work, as specified in pertinent sections of Division 01.
- E. Pay expenses due to re-testing and re-inspection necessitated by incomplete, inefficiently scheduled, improperly performed, defective or nonconforming work, as specified in pertinent sections of Division 01.

**END OF SECTION**

**SECTION 04 2200**  
**CONCRETE MASONRY UNIT CONSTRUCTION**

**PART 1 GENERAL**

**1.01 SECTION INCLUDES**

- A. Provide all labor, material and equipment and perform all operations required to complete all masonry work as indicated on the drawings and specified.
  - 1. Integral Water-Repellent Above-Grade CMU
  - 2. Integral Water-Repellent Above-Grade Mortar
  - 3. Mortar Admixtures
  - 4. Accessories
- B. Additional work included in this section: Provision of concrete grout and installation of items provided by other trades that are embedded in and/or attached to masonry work; providing forms at block-outs and formed concrete grout.

**1.02 RELATED SECTIONS**

- A. Section 01 4523 - Testing Laboratory Services
- B. Section 03 1000 - Concrete Forming
- C. Section 03 2000 - Concrete Reinforcing
- D. Section 03 3000 - Cast-In-Place Concrete
- E. Section 05 1200 - Structural Steel
- F. Section 05 5000 - Metal Fabrications
- G. Section 07 6200 - Sheet Metal Flashing and Trim
- H. Section 09 9113 - Exterior Painting
- I. Division 23: Pertinent sections specifying Mechanical and Plumbing work related to masonry
- J. Division 26: Pertinent sections specifying Electrical work related to masonry

**1.03 REFERENCES**

- A. ASTM Standard C 90, Specification for Load Bearing Concrete Masonry Units
- B. ASTM Standard C 270, Specification for Mortar for Unit Masonry
- C. ASTM Standard C 387, Specification for Packaged, Dry, Combined Materials for Mortar and Concrete
- D. ASTM Standard C 494, Specifications for Chemical Admixtures to Concrete
- E. ASTM Standard C780, Method for Preconstruction and Construction Evaluation of Mortars for Plain and Reinforced Unit Masonry
- F. ASTM Standard C 1142, Standard Specification for Ready-Mixed Mortar for Unit Masonry
- G. ASTM Standard E 72, Method for Conducting Strength Tests of Panels for Building Construction
- H. ASTM Standard E 96, Test Method for Water Vapor Transmission of Materials
- I. ASTM Standard E 514, Test Method for Water Permeance of Masonry



#### 1.04 SUBMITTALS

- A. See Section 01 3300 - Submittals, for submittal procedures.
- B. Product Data: Provide for each product, properties, samples and complete installation details and procedures.
- C. Shop Drawings: Indicate the following:
  - 1. Shop Drawings for all shapes and sizes of Unit Masonry shown and scheduled on the drawings.
  - 2. Layout of vertical control joints in masonry walls coordinated with structural and architectural drawings.
- D. Mix design for all grout, prepared by a qualified testing laboratory. Mix shall conform to all requirements herein.
- E. Selection Samples: Submit physical samples of manufacturer's full range of masonry unit and mortar colors. Initial color selections will be made from selection samples. Final selections of color will only be made from Verification Samples.
  - 1. Submit physical samples of manufacturer's full range of mortar colors.
- F. Verification Samples: Following color selections made by the Architect from initial selection samples, submit two full masonry units of each selected color and texture, 8 x 8 x 16 inch (\_\_\_\_x\_\_\_\_ mm) in size, illustrating range of selected colors, textures and other specified features.
- G. Test Reports: Indicate each of the following.
  - 1. Building code listings
  - 2. Design compliance data
  - 3. UL test data
  - 4. NCMA water permeance test data
  - 5. DRY-BLOCK producer qualifications, and other applicable testing by independent testing laboratories.
- H. Certificates: Certify that products of this section meet or exceed specified requirements.
  - 1. Certifications of Compliance and test data by concrete masonry unit supplier showing conformance to specified material strengths and properties.
- I. Warranty: Submit manufacturer warranty and ensure that forms have been completed in Owner's name and registered with manufacturer.

#### 1.05 QUALITY ASSURANCE

- A. Fabricator of CMU: Fabricators of CMU shall be qualified DRY-BLOCK producers satisfying requirements of GRACE CONSTRUCTION PRODUCTS.
- B. Regulatory requirements: Published specifications, standards, tests or recommended methods of trade, industry or governmental organizations apply to work of this section where cited by abbreviations noted below.
  - 1. ASTM Standard C 90, Specification for Load Bearing Concrete Masonry Units
  - 2. ASTM Standard C 270, Specification for Mortar for Unit Masonry
  - 3. ASTM Standard C 387, Specification for Packaged, Dry, Combined Materials for Mortar and Concrete
  - 4. ASTM Standard C 494, Specifications for Chemical Admixtures to Concrete
  - 5. ASTM Standard C780, Method for Preconstruction and Construction Evaluation of Mortars for Plain and Reinforced Unit Masonry

6. ASTM Standard C 1142, Standard Specification for Ready-Mixed Mortar for Unit Masonry
  7. ASTM Standard E 72, Method for Conducting Strength Tests of Panels for Building Construction
  8. ASTM Standard E 96, Test Method for Water Vapor Transmission of Materials
  9. ASTM Standard E 514, Test Method for Water Permeance of Masonry
- C. California Building Code (CBC), C.C.R., Title 24, Part 2, 2010 edition, Chapter 19 Concrete and Chapter 21A, Masonry.
- D. Inspection and Testing by Owner's Testing Laboratory:
1. General: Review and approve contractor submittals related to design strengths of concrete masonry construction. Provide reports to Architect/ Engineer and DSA indicating results of reviews, tests and inspections.
  2. All testing of concrete unit masonry by the Owner's Testing Laboratory shall comply with the requirements of CBC Chapter 21A, Section 2105A.3, for assumed design strength of  $f'm = 1500$  psi.
  3. Masonry Core Testing: Not less than two cores having a diameter of 6 inches, shall be taken from each project. Two cores shall be taken from each building for each 5,000 square feet of the greater of the masonry wall area or the floor area, or fraction thereof. The Architect or Structural Engineer in responsible charge of the project or his/her representative (inspector) shall select the areas for sampling. One half of the number of cores taken shall be tested in shear. The shear wall loadings test both joints between the grout core and the outside wythes of the masonry. Core samples shall not be soaked before testing. Materials and workmanship shall be such that that for all masonry, when tested in compression, cores shall show an ultimate strength at least equal to the  $f'm$  assumed in design, but not less than 1,500 psi. When tested in shear, the unit shear on the cross section of the core shall not be less than 2.5 times the square root of  $f'm$  psi.
    - a. Shear testing apparatus shall be of a design approved by the enforcement agency. Visual examination of all cores shall be made to ascertain if the joints are filled.
    - b. The Project Inspector or Testing Agency shall inspect the coring of the masonry walls and shall prepare a report of coring operations for the testing laboratory files and mail one copy to the enforcement agency. Such reports shall include the total number of cores cut, the location, and the condition of all cores cut on each project, regardless of whether the core specimens failed during cutting operation. All cores shall be submitted to the laboratory for examination. The laboratory shall retain all cores for the Owner's use.
  4. Masonry Prism Testing: The compressive strength of masonry determined in accordance with CBC Chapter 21A for each set of prisms shall equal or exceed  $f'm$ . Compressive strength of prisms shall be based on tests at 28 days. Compressive strength at seven days or three days may be used provided a relationship between seven-day and three-day and 28-day strength has been established for the project prior to the start of construction. Verification by masonry prism testing shall meet the following:
    - a. A set of five masonry prisms shall be built and tested in accordance with CBC Chapter 21A prior to the start of construction. Material used for construction of the prisms shall be taken from those specified to be used in the project. Prisms shall be constructed under the observation of the engineer or special inspector or an approved agency, and tested by an approved agency.
    - b. A set of three prisms shall be built and tested during construction in accordance with CBC Chapter 21A for each 5,000 square feet of wall area, but not less than one set of three masonry prisms for the project.

5. Owner's testing laboratory shall provide continuous inspection by a specially approved inspector of masonry construction. All structural masonry work shall be continuously inspected during laying and grouting by an inspector specially approved for that purpose by the enforcement agency (Division of the State Architect/DSA). The inspector shall make test samples and perform such tests as are required and shall check the materials, details of construction, and construction procedures. The special masonry inspector shall furnish a verified report that, of his own personal knowledge, the work covered by the report has been performed, and material used and installed in every material respect in compliance with the duly approved plans and specifications.
- E. Contractor shall provide adequate materials for sampling and shall patch core holes made by the testing laboratory using non shrink, high-strength grout.

#### **1.06 MOCK-UP**

- A. Provide mockup of concrete masonry under provisions of Section 01400 - Quality Control. Before installation of masonry system, verify color and textural characteristics selected under sample submittals of masonry units and mortar. Erect a mock-up on site in locations directed, of sufficient size to represent examples of all specified concrete and glass masonry units, with all accessories and materials to be included in wall system for the Architect's approval of size, texture and color of block, mortar and joint pattern.
- B. Accepted Mockup shall serve as the standard of quality for subsequent work.
- C. Accepted Mockup may remain as part of the Work.
- D. Remove rejected Mockups completely.
- E. Locate in mutually accepted location.

#### **1.07 PRE-INSTALLATION MEETING**

- A. Preconstruction Meetings: Under provisions of Section 01039 - Coordination and Meetings, before fabrication or installation of components of the masonry wall system, conduct a meeting at Project site with Architect, Inspector, Testing Agency, sub-contractors, installers of related work, and other involved entities.
- B. Convene one week before starting work of this section.

#### **1.08 DELIVERY, STORAGE, AND PROTECTION**

- A. Deliver and store packaged material in original containers with seals unbroken and labels intact until time of use under provisions of 01600 - Product Requirements.
- B. Unload masonry units carefully and store on raised platform protected from weather.
- C. Protect cementitious materials against exposure to moisture. Use of cementitious or other materials that have become caked and hardened from absorption of moisture will not be permitted.
- D. Components of the Masonry Wall System: Comply with GRACE CONSTRUCTION PRODUCTS - Masonry Products specific recommendations for storage and handling of each product.

#### **1.09 PROJECT CONDITIONS**

- A. Environmental Conditions: Do not place unit masonry when temperature is below 50 degrees Fahrenheit or above 90 degrees Fahrenheit unless the Architect approves and the Contractor provides means for preventing damage from freezing before and after placement.

- B. Protection: Protect surrounding work as required against damage from masonry work. Clean satisfactorily or otherwise correct damage to surrounding work resulting from masonry work.
- C. Coordinate masonry installation with size, location and installation of service utilities.
- D. Sequence masonry installation activities to allow sufficient time for: Review of all submittals, including Selection and Verification Sample Submittals, fabrication of materials and required test durations as specified. Indicate submittal review, procurement, fabrication, curing, mock-up and testing activities in the project schedule prior to the start of installation. Installation durations shall be based on low-lift installation methods specified.

#### 1.10 WARRANTY

- A. See Section 01 7000 - Closeout Submittals, for additional warranty requirements.

### PART 2 PRODUCTS

#### 2.01 MATERIALS

- A. Hollow Load-Bearing Concrete Masonry Units: as manufactured by Qualified DRY-BLOCK producer.
  - 1. General: All concrete masonry units shall be made with expanded shale aggregates, shall be double open end wherever possible, (single open end otherwise) and shall conform to CBC Chapter 21A . Units to be tested in conformance with CBC Chapter 21A.
  - 2. Concrete masonry units to be used in concrete masonry shall be grade N, medium or light weight.
  - 3. See Articles in this Section titled PLACEMENT and GROUTING for additional requirements.
  - 4. Integral Water Repellent Admixture: DRY-BLOCK WATER REPELLENT ADMIXTURE by GRACE CONSTRUCTION PRODUCTS.
  - 5. CMU Pigments: Natural and synthetic iron oxides and chromium oxides, manufactured specifically for use in CMU. Allow for selection of premium and custom colors.
  - 6. Color, size, shape, and texture:
    - a. As indicated or required to produce patterns indicated.
    - b. Architect will select multiple colors and finishes from the full range of available colors including all "custom" or "premium" colors produced by the manufacturer. Minimum of eighteen (18) standard selections. No additional costs will be allowed due to Architect's color selection. Locations of colors as indicated or as directed.
- B. Portland Cement: ASTM C150, Type II, low alkali
- C. Aggregates:
  - 1. For Mortar: ASTM C-144 and CBC Chapter 21A
  - 2. For Grout: ASTM C404 and CBC Chapter 21A
- D. Hydrated Lime: ASTM C207, Type S
- E. Quick Lime: ASTM C5-04, high calcium
- F. Reinforcing Steel: ASTM A-615, Grade 60 #4 and larger, Grade 40 #3 and smaller.
- G. Water: Clean and potable, free from impurities detrimental to mortar and grout.
- H. Sika Grout Aid; Sika Corporation P.O. Box 297 Lyndhurst, New Jersey (201)933-8800.
- I. Preformed expansion joint filler (bituminous), ASTM D994.
- J. High-Strength Grout: Conform to CRD-C621 and CRD-C588, non-ferrous.

- K. Flexible sealant to conform to Federal Specification TT- S-002 30C, Type II, Class A.
- L. Colored Mortar Pigments: Natural and synthetic iron oxides and chromium oxides, manufactured specifically for use in mortar. Submit full range of available colors including "custom" and "premium" to Architect for selection. No additional costs will be allowed due to Architect's selection of colors. Selection may match or contrast with masonry colors.
- M. Integral Water Repellent Mortar Admixture: DRY-BLOCK WATER REPELLENT MORTAR ADMIXTURE BY GRACE CONSTRUCTION PRODUCTS .
- N. Life-Extending Mortar Admixture: MORTARD-E mortar admixture used to control setting time and workability properties of extended life mortar for unit masonry by GRACE CONSTRUCTION PRODUCTS.

## 2.02 ACCESSORIES

- A. Accessory Materials: All materials not specifically indicated but required to achieve the results specified; commercial quality. Types recommended by manufacturer to suit conditions or as required by referenced standards.

## 2.03 MIXES AND MIXING

- A. Mortar:
  - 1. Mix Design for mortar shall be Type S, compressive strength: 1800 psi minimum at 28 days, otherwise conform to CBC Chapter 21A, Section 2103A.8.
  - 2. Mix in batch mechanical mixer permitting accurate control of water amounts.
  - 3. Mix materials for at least three minutes with minimum amount of water to produce workable consistency.
  - 4. Use and place mortar in final position within 2-1/2 hours after mixing. Mortars that have stiffened due to evaporation of water may be retempered with water as frequently as required to restore required consistency during this time period.
  - 5. Provide integrally colored mortar of selected color. Add mortar colors in accordance with manufacturer's recommendations. Ensure uniformity of mix and coloration.
  - 6. Provide DRY-BLOCK MORTAR ADMIXTURE, MORTARD-E at rates recommended by GRACE CONSTRUCTION PRODUCTS
  - 7. Workability Admixtures: Review for compatibility with GRACE CONSTRUCTION PRODUCTS. Mix at rates to comply with recommendations of manufacturer.
  - 8. Field test specimens per CBC, Chapters 17A and 21A.
- B. Concrete Grout:
  - 1. Six (6) sacks of cement per yard minimum. Concrete masonry grout compressive strength to attain 2000 psi after 28 days minimum. Admixture not allowed unless specified herein.
  - 2. One lb. Sika Grout Aid per sack of cement (#6 maximum per cubic yard).
  - 3. Slump: 8 to 10 inches.
  - 4. Otherwise conform to CBC Chapter 21A, Section 2103A.12.
- C. General Mixing Requirements:
  - 1. Measure materials accurately. Shovel measurements will not be permitted.
  - 2. Use mechanical mixer of at least one sack capacity.
  - 3. Mix for minimum of three minutes and in no case less than time required for securing uniform mass.
  - 4. Completely empty drum before charging succeeding batch of materials.
  - 5. Exercise extreme care in measuring ingredients for partial batches.

## **2.04 FABRICATION**

- A. Reinforcement: Conform to requirements of Section 03 3200, Concrete Reinforcing.
- B. Architectural Concrete Masonry Units (CMU):
  - 1. Fabricate CMU to comply with referenced standards, as manufactured by a qualified DRY-BLOCK producer using DRY-BLOCK ADMIXTURE at a rate recommended by GRACE CONSTRUCTION PRODUCTS.
  - 2. Colors are specified as part of CMU appearance, add at a rate recommended by manufacturer of colorant to provide uniform and consistent coloration matching selected samples.

## **2.05 SOURCE QUALITY CONTROL AND TESTS**

- A. Owner's Inspector and Testing Agency will perform source sampling, inspection and testing in accordance with Section 01 4523, Testing and Inspection Services and as specified above.
- B. Contractor shall provide adequate materials for sampling, access to stored materials and incidental labor as needed to assist the testing agency in sampling.

## **PART 3 EXECUTION**

### **3.01 EXAMINATION**

- A. Examine areas to receive masonry and verify following:
  - 1. That foundation surface is level to permit bed joint within range of 1/4-to 3/4-inch.
  - 2. That edge is true to line to permit projection of masonry to less than 1/4-inch.
  - 3. That projecting dowels are free from loose scale, dirt, concrete or other bond-inhibiting substances and properly located.
  - 4. Compliance with requirements for installation tolerances and other specific conditions affecting the performance of unit masonry.
- B. Do not begin work before unsatisfactory conditions have been corrected.

### **3.02 PREPARATION**

- A. Clean concrete surfaces to receive masonry. Remove laitance or other foreign material lodged in surface by sandblasting or other means as required. Roughen foundation bed to expose aggregate; remove loose particles and saturate before laying units.
- B. Ensure masonry units are clean and free from dust, dirt or other foreign materials before laying.
- C. Direct and coordinate placement of metal anchors supplied for installation under other sections.
- D. Provide temporary bracing during installation of masonry work. Maintain in place until building structure provides permanent bracing. Provide all bracing and support work required to construct work indicated. Drawings do not contain details or designs for required bracing.

### **3.03 REINFORCEMENT**

- A. Place bars where noted in accordance with drawings and ACI 315. Do not disturb after start of masonry placement.

- B. Splice bars with dowels cast in concrete; lap bars per drawings. Bars shall not be "stabbed" after grout placement. All reinforcing shall be tied in place with wire prior to grout placement. The use of approved bar spacers is acceptable.

### 3.04 PLACEMENT

A. General Requirements:

1. Ensure masonry units are sound, clean and free of cracking at time of placement.
2. Accurately cut and fit units as required to accommodate work of other sections using masonry saws.
3. Lay masonry units plumb, true to line with level courses accurately placed. Maximum tolerance 1/4" in 8'-0".
4. Adjust unit to final position while mortar is soft and plastic.
5. Align vertical cells accurately.
6. Remove units disturbed after stiffening of mortar, clean joints and re-lay unit with fresh mortar.
7. Do not attach construction supports to walls.
8. Install anchor bolts and other embedded items accurately as work progresses. Use templates as necessary to meet required tolerance of other's work.
9. Brace walls adequately until supporting structure is complete.
10. Do not place conduit, pipes, wire, etc. in cells containing reinforcing steel.

B. Joints:

1. Fill joints; ensure full coverage of face shells in both horizontal and vertical joints and on webs.
2. Tool (concave) and finish joints as specified to achieve solid, smooth, watertight compacted joint.
3. Immediately fill holes made by line pin with mortar when pin is withdrawn.
4. Remove surplus mortar from joints.
5. Provide vertical control joints at 40' o.c. maximum and as detailed on the structural drawings.

C. Cold Weather Requirements:

1. When daily temperature is below 50 degrees Fahrenheit, ensure reinforcing, masonry units, etc., contacting mortar and grout are free of frost.
2. Protect all mortar and grout from freezing for at least 48 hours after installation whenever temperature falls below 40 degrees Fahrenheit.
3. Maintain mortar and grout at temperature no lower than 50 degrees F. while being used and until installed.
4. Provide equipment of adequate size for heating of mortar and grout when required in freezing or near freezing weather.
5. Do not add water to mix at temperature greater than 140 degrees Fahrenheit.
6. Use of admixtures or antifreezes will not be permitted.
7. Otherwise conform to CBC Chapter 21A.

D. Protection

1. Protect face materials against staining.
2. Remove misplaced grout or mortar immediately.
3. Protect sills, ledges, off-sets and similar items from mortar drippings or other damage during construction.

E. Concrete Masonry Units

1. Coursing: Coursing, bond patterns, and textures shall be as indicated.
2. Joint Thickness: 3/8-inch both vertically and horizontally.

3. Joint Treatment:
  - a. Typical exterior and interior walls; tool joint for weather tightness.
  - b. Construction joints to be sealed with joint sealant or high strength grout as noted on the drawings.
4. Use proper units to provide for doors, bond beams lintels, etc., in order to minimize cutting.
5. Do not wet units.
6. Align vertical cells to provide continuous, unobstructed opening for grouting.
7. Corners: Provide standard masonry bond by overlapping units.
8. Provide inverted bond units at beginning of each lift to aid in cleaning and flushing.
9. Mortar Bedding and Jointing: Lay CMU units with face shell bedding using DRY-BLOCK MORTAR ADMIXTURE per manufacturer's recommendations. Tool all mortar joints. Raked joints are not permitted unless properly caulked. Take care to remove mortar containing DRY-BLOCK MORTAR ADMIXTURE from the CMU face before it sets.
10. Cover top courses at the end of the work day, and follow manufacturer's recommendations for proper protection and curing of the wall.

### 3.05 CONCRETE GROUTING

- A. General Requirements:
  1. Grout void between wythes and cells of concrete block.
  2. Ensure grout flows into voids and completely surrounds reinforcing steel.
  3. Stop grout approximately one inch below top of last course except at top course without a concrete cap.
  4. Grout from inside face of masonry wherever possible.
  5. Where necessary to stop longitudinal run, provide suitable dam to retain grout in place.
  6. Clean all cells at bottom of lift space prior to grouting. Remove all loose mortar, etc.
  7. Consolidate grout with a mechanical vibrator with a 3/4" head.
  8. Slushing with mortar will not be permitted.
  9. Use grout pump, hopper or bucket to place grout.
  10. Do not wet down grout spaces prior to grouting.
  11. Locate cleanouts to minimize visual impact. Verify with Architect/Engineer.
  12. Otherwise conform to CBC Chapter 21A.
- B. Low Lift Grouting: Conform to CBC Chapter 21A Section 2104A.5.1.1.
  1. No lift will be permitted to exceed 2 feet (24 inches) maximum. Provide clean outs where thorough cleaning and flushing is difficult, and as specifically directed in the field by the Architect to facilitate inspections. Provide inverted bond block at first and each lift to facilitate cleaning.

### 3.06 BUILT-IN WORK

- A. Coordinate masonry installation with the work of other sections.
- B. As work progresses, install built-in metal door frames, fabricated metal frames, anchor bolts, plates, and plumbing or electrical fixtures and other items to be built into the work and furnished under other sections.
- C. Install built-in items plumb, level, and true to line.
- D. Bed anchors of metal door and glazed frames in adjacent mortar joints. Fill frame voids solid with grout.
- E. Do not build into masonry construction organic materials that are subject to deterioration.



### 3.07 TOLERANCES

- A. Maximum Variation from Alignment of Columns: 1/4 inch (6 mm).
- B. Maximum Variation From Unit to Adjacent Unit: 1/16 inch (1.6 mm).
- C. Maximum Variation from Plane of Wall: 1/4 inch in 10 ft (6 mm/3 m) and 1/2 inch in 20 ft (13 mm/6 m) or more.
- D. Maximum Variation from Plumb: 1/4 inch (6 mm) per story non-cumulative; 1/2 inch (13 mm) in two stories or more.
- E. Maximum Variation from Level Coursing: 1/8 inch in 3 ft (3 mm/m) and 1/4 inch in 10 ft (6 mm/3 m); 1/2 inch in 30 ft (13 mm/9 m).
- F. Maximum Variation of Joint Thickness: 1/8 inch in 3 ft (3 mm/m).

### 3.08 CUTTING AND FITTING

- A. Cut and fit for pipes, conduit, sleeves, grounds, and reglets. Grind surfaces of split-faced masonry surfaces where required to obtain tight fit and hairline intersections with flashings, escutcheons or other similar features. Coordinate with other sections to provide work of correct size, shape, and location.
- B. Obtain approval prior to cutting or fitting masonry work not indicated or where appearance or strength of masonry work may be impaired.

### 3.09 FIELD QUALITY CONTROL

- A. Owner's Inspector and Testing Agency will perform field inspection and testing in accordance with Section 01 4523 and as specified above.
- B. Contractor shall provide adequate materials for sampling, access to stored materials and incidental labor as needed to assist the testing agency in sampling.

### 3.10 POINTING AND CLEANING

- A. Point holes or defective mortar joints upon completion of work; where necessary, cut out and repoint defective joints.
- B. At end of work day, fiber brush new surfaces to remove mortar splashes, clean with mild detergent or enzymes, and rinse with clean water.
- C. When ordinary methods are not adequate, employ sandblasting, chipping or other special methods.
- D. Do not use acid solution to remove green stain or efflorescence resulting from vanadium salts. Follow recommendations of manufacturer for removal of such stains.
- E. Upon completion of work, remove from site surplus materials, rubbish and debris resulting from this work.

### 3.11 PROTECTION

- A. Protect installed work from subsequent construction operations. Repair damage prior to acceptance.

**3.12 CONCRETE MASONRY STRENGTHS**

- A. Concrete masonry shall have an assumed 28 day prism strength of 1500 psi.

**END OF SECTION**

## SECTION 05 1100

### STRUCTURAL AND MISCELLANEOUS STEEL

#### PART 1 GENERAL

##### 1.01 SUMMARY

- A. Section Includes: All labor, materials, equipment and operations required to complete structural and miscellaneous metals in shapes and configurations indicated; including:
1. Structural steel columns, beams, bracing, base plates, bolts, joist hangers, and stud bolts welded to structural steel.
  2. Miscellaneous structural steel and connections; fabricated connectors and hangers installed by related sections.
  3. Anchor bolts and steel inserts embedded in concrete or masonry, installed by related sections.
  4. Fabricated steel items embedded in concrete or masonry installed by related sections.
  5. Supervision of anchor bolt setting, leveling and elevations to insure required fit of steel work.
  6. Shop priming and field touch-up, galvanizing.
  7. Bracing, Shoring, Fabrication and Erection.
- B. Related Sections:
1. Pertinent sections of Division 01 specifying Quality Control and Testing Agency services.
  2. Pertinent Sections of other Divisions specifying concrete reinforcement, formwork, concrete, structural and miscellaneous metal fabrications, steel joists, metal decking, cold-formed metal framing, rough carpentry.

##### 1.02 REFERENCES

- A. California Code of Regulations, Title 24, latest adopted edition (herein noted as CBC): Chapter 22A Steel.
- B. American Institute of Steel Construction (AISC) 303 "Code of Standard Practice for Steel Buildings and Bridges".
- C. AISC 360 "Specification for Structural Steel Buildings".
- D. American Welding Society (AWS) D1.1 "Structural Welding Code - Steel".
- E. Underwriters Laboratories (UL) FRD "Fire Resistance Directory".

##### 1.03 SUBMITTALS

- A. Submit in accordance with pertinent sections of Division 01 specifying submittal procedures. The General Contractor shall review and approve shop drawings prior to submittal to the Architect/Engineer. Submittals that do not meet these requirements will be returned for correction without review.

- B. Limitation of Review: Structural Engineer's review will be for general conformance with design intent as indicated in the Contract Documents and does not relieve Contractor of full responsibility for conformance with the Contract Documents.
- C. Product Data: Submit manufacturer's product data, specifications, location and installation instructions for proprietary materials and reinforcement accessories. Provide samples of these items upon request.
- D. Shop drawings: Submit each building as a complete unit. Do not mix components from multiple buildings or units of work in a submittal. Include all of the following;
  - 1. Profiles, sizes, spacing, locations of structural members, openings, attachments, and fasteners.
  - 2. Fabrication tolerances for all steel.
  - 3. Connections: All, including type and location of shop and field connections.
  - 4. Indicate welded connections with AWS A2.4 welding symbols. Indicate net weld lengths, type, size, and sequence. Designate demand critical welds.
  - 5. Designation of Seismic Force Resisting System (SFRS) members and connections. Locate and dimension protected zones. Brace frame gusset plates shall be drawn to scale.
  - 6. Cross-reference all shop drawing detail references to contract document detail references.
  - 7. Secure all field measurements as necessary to complete this work prior to submitting shop drawings for review.
  - 8. Provide holes, welded studs, etc. as necessary to secure work of other sections.
  - 9. Provide the following as separate submittals for each building or unit of work:
    - a. Bolt and anchor setting plans.
    - b. Layout, fabrication and erection drawings.
- E. Certifications:
  - 1. Steel Materials: Submit the following for identified materials.
    - a. Manufacturer's Mill Certificate: Certify that products meet or exceed specified requirements.
    - b. Mill Test Reports: Indicate structural strength, destructive test analysis, and non-destructive test analysis.
    - c. Contractor's affidavit certifying that all identified steel materials provided are of the grades specified and match the certificates supplied.
  - 2. Welders Certificates: Certify welders employed on the Work, verifying AWS qualification per AWS D1.1.
- F. Samples: Provide samples to the Testing Agency as specified in Article SOURCE QUALITY CONTROL, at no additional costs.

#### **1.04 QUALITY ASSURANCE**

- A. Requirements of Regulatory Agencies, refer to pertinent sections of Division 01 and CBC Chapter 17A.
- B. All tests shall be performed by a recognized testing agency as specified in pertinent sections of Division 01.

- C. Certification and Identification of Materials and Uses: Provide Testing Agency with access to fabrication plant to facilitate inspection of steel. Provide notification of commencement and duration of shop fabrication in sufficient time to allow inspection and all material identification/test information listed below.
1. Test all steel as required by ASTM A6.
  2. Provide manufacturer's Mill Test Reports for all materials. Include chemical and physical properties of the material for each heat number manufactured. Tag all fabricated materials with heat number.
  3. Provide letter certifying all materials supplied are from heat numbers covered by supplied mill certificates. Include in letter the physical location of each material type and/or heat number in the project (i.e. walls, braced frames etc.).
  4. Unidentified Material Tests: Where identification of materials by heat number or mill tests cannot be made, Owner's Testing Agency shall test unidentified materials.
  5. Provide all certification, verifications, and other test data required to substantiate specified material properties at no additional cost to the Owner.
- D. Testing and Inspection: Tests and Inspections performed by Independent Testing Agency are specified below in Articles SOURCE QUALITY CONTROL and FIELD QUALITY CONTROL. Duties and limitations of Independent Testing Agency, test costs and test reports in conformance with pertinent sections of Division 01.
- E. The following standards are the minimum level of quality required. Provide higher quality work as specifically indicated in the Contract Documents.
1. Workmanship and details of structural steel work shall conform to the CBC and AISC 360.
  2. The quality of materials and the fabrication of all welded connections shall conform to AWS D1.1.
  3. Comply with Section 10 of AISC 303 for architecturally exposed structural steel.
- F. The Testing Agency will review all submittals and testing of materials.
- G. All re-inspections made necessary by non-conforming work shall be at the Contractor's expense.

#### **1.05 DELIVERY, STORAGE AND HANDLING**

- A. Deliver materials to project site in bundles marked with durable tags indicating heat number, mill, member size and length, proposed location in the structure and other information corresponding with markings shown on placement diagrams.
- B. Handle and store materials above ground to prevent damage, contamination or accumulation of dirt or rust.

#### **1.06 SCHEDULING AND SEQUENCING**

- A. Organize the work and employ shop and field crew(s) of sufficient size to minimize inspections by the Testing Agency.
- B. Provide schedule and sequence information to Testing Agency in writing upon request. Update information as work progresses.

## **PART 2 - PRODUCTS**

### **2.01 MATERIALS**

- A. Structural Steel W Shapes: ASTM A992 Gr. 50 or ASTM A572 Gr. 50.
- B. Structural Steel Plates: ASTM A36 or ASTM A572 Gr. 50 or ASTM 529 Gr. 50
- C. Structural Steel Channels, Angles: ASTM A36 or ASTM A572 Gr. 50.
- D. HSS (Hollow Structural Sections):
  - 1. Round: ASTM A500, Gr. C.
  - 2. Rectangular or Square: ASTM A500, Gr. C.
- E. Pipe: ASTM A53, Grade B.
- F. Bolts, Nuts, and Washers: ASTM A307 Grade A machine bolts with ASTM A563 Grade A nuts and ASTM F844 washers to match. See FINISHES section for galvanization, where required.
- G. Anchor Bolts/Rods, Nuts, and Washers: ASTM F1554 Gr. 36 or 55 with ASTM A563 Grade A nuts, and ASTM F436 Type 1 washers. Grade DH nuts where Grade 105 rod is specified. No upset thread allowed.
- H. Arc-Welding Electrodes: AWS Standards E70 or equivalent, except no E70T-4 allowed.
- I. Other Welding Materials: AWS D1.1; type required for materials being welded.
- J. Welded Headed/Threaded Studs: ASTM A108 and AWS D1.1 Section 7. Minimum yield strength is 51,000 pounds per square inch.
- K. Deformed Bar Anchors: ASTM A496.

### **2.02 ACCESSORIES**

- A. High Strength Grout: ASTM C1107, non-shrink, premixed compound consisting of aggregate, cement, and water reducing plasticizing agents. Minimum compressive strength  $f'_c = 7000$  psi at 28 days. Non-metallic where exposed to view. BASF "MasterFlow 928" or equivalent.
- B. Building Structural Steel Primers: Comply with local VOC limitations of authorities having jurisdiction and the California Green Building Code. Verify compatibility with finish coats specified in other sections. Follow manufacturers printed instructions. Apply one coat unless otherwise directed.
  - 1. Type A: Self-Crosslinking Hydrophobic Acrylic passing 2000 hours ASTM D4585 & 7000 hours ASTM D5894. "Series 115 Uni-Bond DF" by Tnemec (2.0 to 4.0 mils DFT).
  - 2. Type B: Organic Zinc-Rich Urethane passing 50,000 hours ASTM B117 and 15000 hours ASTM G855. "Series 90-97 Tneme-Zinc" by Tnemec (2.5 to 3.5 mils DFT) or "Series 94-H20 Hydro-Zinc" by Tnemec (2.5 to 3.5 mils DFT).
  - 3. Type C: MIO-Zinc Filled Urethane passing 10,000 hours ASTM B117 and 5000 hours ASTM D4585. "Series 394 PerimePrime" by Tnemec (2.5 to 3.5 mils DFT).

- C. Galvanizing: ASTM A153 and A123.
- D. Touch-Up Primer for Galvanized Surfaces: Type B primer.

### 2.03 FABRICATION

- A. Shop fabricate to greatest extent possible.
- B. Continuously seal built up members by continuous welds where exposed to weather.
- C. Fabricate connections for bolt, nut, and washer connectors.
- D. Protect all materials, before and after fabrication, from rust, corrosion, dirt, grease, and other foreign matter.
- E. Fabricate framing members free from twists or bends. Form holes, cut and sheared edges neatly without kinks, burrs, or warped edges.
- F. Exposed Steel: Straight, smooth, free of nicks, scars or dents.
- G. Gas Cutting: Gas cutting of holes in a member shall not be permitted.
- H. Splicing of members: Members requiring splicing due to length requirements may be spliced using full penetration butt welds when such welds and procedures are inspected and certified by the Testing Agency, in conformance with AWS and AISC standards. The location of splices shall be approved by the Architect/Engineer in writing prior to fabrication.
- I. Welding: Welding of structural steel connections shall be performed by qualified welders in accordance with AWS Standards. All weld sizes shall match those shown on the drawings.
  - 1. Preparation: Clean all surfaces free of rust, paint and all foreign matter. Remove paint or scale by brushing, chipping or hammering as required. Chip clean and wire brush burned or flame cut edges before welding. Space and alternate welds, clamping as necessary to prevent warp or misalignment.
  - 2. Sequence Welding: When welds enclose, or partially enclose, the perimeter or portion of the surface of a member, make weld bead in sequence, or staggered. Minimize internal stresses. Weld groups of members occurring in a single line in staggered sequence to minimize distortion of the structural frame.
  - 3. Faulty and Defective Welding: Welds failing to meet AWS standards and the Contract Documents shall be rejected and remade at Contractor expense. All welds showing cracks, slag inclusion, lack of fusion, bad undercut or other defects, ascertained by visual or other means of inspection shall be removed and replaced with conforming work.
  - 4. Minimum Weld Strengths: All welds shall match the minimum weld sizes recommended by AISC. Details of fabrication not specifically shown shall match similar details which are specifically shown. All bevel and groove welds shall be full penetration unless size is noted otherwise.
  - 5. Threaded studs, headed studs, and deformed bar anchors shall be full-fusion welded conforming to ASW D1.1.
- J. Camber: Fabricate all beams cambered as indicated on the drawings.

1. Fabricate beams without camber for installation with any "natural" crown up.
  2. Exception: Fabricate cantilever beams with "crown" down.
- K. Grinding: Grind smooth the following structural steel and connections;
1. Exposed cut ends of structural and fabricated shapes.
  2. All welds exposed to view.
  3. Mitered and fit-up corners and intersections.
- L. Back-Up Bars: Required for all complete penetration welds.
- M. Bolt Holes: Edge, end distances and spacing shall conform to dimensions shown on the drawings, and as follows;
1. Round: Size indicated and 1/16 inch maximum oversize, except 1 inch and larger bolts may have 1/8 inch maximum oversize.
  2. Slotted: At locations specifically noted on the drawings, provide size indicated and 1/16 inch by 1/4 inch oversize slotted in direction perpendicular to applied loads.
  3. Holes in base plates for anchor bolts may be 1/8 inch oversize.

## 2.04 FINISHES

- A. Steel exposed to inclement atmospheric conditions or weather (such as coastal moisture or seasonal rain) shall be sufficiently primed or otherwise protected against corrosion. If condition of steel is suspect due to weathering/corrosion, Contractor shall bear cost of inspection to determine if excessive corrosion is present and if steel member(s) requires repair or replacement. Contractor shall bear cost of repair or replacement.
- B. Prepare and finish structural and miscellaneous steel component surfaces as follows, unless a higher standard-of-care is determined necessary per item A:
1. Unpainted, interior, dry exposure surfaces need not be primed.
  2. Finished painted, interior, dry exposure surfaces:
    - a. Surface Preparation: SSPC-SP2 Hand-Tool and/or SP3 Power-Tool Cleaning. Apply Primer Type A. Field touchup with same primer.
    - b. Where jobsite exposure is expected to exceed 6 months, SSPC-SP6 / NACE No. 3 Commercial Blast-Cleaning is required. Apply Primer Type B or C. Field touchup with same primer.
  3. Finish painted surfaces with exterior exposure, interior exposure subject to wet conditions or fumes, or surfaces to receive high performance finish coatings (for example epoxy or urethane coatings).
    - a. Surface Preparation: SSPC-SP6 / NACE No. 3 Commercial Blast-Cleaning to create a dense, uniform angular surface profile of 2.0 mils minimum. For severe (immersion) exposure, SSPC-SP10 / NACE No. 2 Near-White Blast-Cleaning is required.
    - b. Apply Primer Type B. Field touchup with same primer.
  4. Surfaces to be fire proofed need not be primed unless required by the fireproofing manufacturer or if jobsite exposure is expected to be inclement per item A. Where unprimed steel is to receive fireproofing, prepare steel surface as required by fireproofing manufacturer. If fireproofed surfaces are to be primed, provide primer as follows:
    - a. Surface Preparation: SSPC-SP3 Power-Tool Cleaning.



- b. Apply Primer Type C. Field touchup with same primer.
5. Exterior exposed (unpainted) surfaces and as otherwise indicated to receive galvanizing:
  - a. Galvanize per ASTM A123 Class 55 minimum. Passivation agents are not permitted on galvanized metal that is to be painted. Provide vent holes per ASTM A385 at closed sections (such as HSS). Submit proposed location of vent holes for review by Engineer.
  - b. Connection hardware shall be hot-dip galvanized per ASTM A153 or F2329. Mating bolts and nuts shall receive the same zinc-coating process.
  - c. Repair all uncoated, damaged, or altered galvanized surfaces per ASTM A780.
- C. Do not prime the following surfaces unless otherwise indicated:
  1. Connections to be field welded.
  2. Steel in contact with concrete.
  3. Surfaces to receive welded metal decking.
- D. Do not cover up work with finish materials until inspection is complete and work is approved by the Testing Agency.

## 2.05 SOURCE QUALITY CONTROL

- A. An independent Testing Agency will perform source quality control tests and submit reports, as specified in pertinent sections of Division 01.
- B. Steel Materials Testing:
  1. No testing is required for materials identified in accordance with CBC 2202A.1 (heat number, grade stencil, etc.).
  2. Unidentified steel- General: Test all structural shapes. In addition, test to verify  $F_y$  and  $F_u$  values when engineering requirements exceed  $F_y = 25$  ksi for design.
- C. Shop Welding Inspection:
  1. Testing Agency shall inspect and certify all structural welds.
  2. Welder Qualifications: Welding inspector shall verify that all the welders are properly qualified prior to steel fabrication and state the qualifications of each welder in the welding inspection report.
  3. Welding Inspection: Continuous inspection required unless otherwise noted below. Comply with requirements of AWS D1.1.
    - a. Welding Inspector shall check all welds, materials, equipment and procedures.
    - b. Welding Inspector shall provide reports certifying the welding is as required and has been done in conformity with the plans, specifications and codes.
    - c. Welding Inspector shall use radiographic, ultrasonic, magnetic particle, or any other necessary aid to visual inspection to assure adequacy of welds. Ultrasonic Testing (UT) shall be required for all complete joint penetration (CJP) welds of material 5/16 inch thick or greater.
  4. Periodic Inspection Acceptable:
    - a. Single pass fillet welds not exceeding 5/16 inch.

- D. Bolts, Nuts, and Washers: Provide samples to Testing Agency for required testing, at no additional cost.

### **PART 3 EXECUTION**

#### **3.01 EXAMINATION**

- A. Verify that conditions are appropriate for erection of structural steel and that the work may properly proceed.

#### **3.02 ERECTION**

- A. Erect structural steel in compliance with AISC 303.
- B. Framing:
  - 1. Erect all structural steel true and plumb.
  - 2. Verify proper final alignment prior to making final connections.
- C. Field Connections:
  - 1. Workmanship of field bolted and welded connections shall conform in all respects to methods and tolerances specified for fabrication.
  - 2. Field weld components indicated on shop drawings. Sequence field welds to minimize built-up stress and distortion of the structural frame. Verify sequence with Engineer. Coordinate field welding schedule with Testing Laboratory.
  - 3. Welded Studs: Install in accordance with manufacturer's instructions and structural welding code AWS D1.1.
- D. Templates: Provide bolt setting templates for all anchor bolts. Provide instructions for the setting of anchors and bearing plates, verify these items are set correctly as work progresses.
- E. Column base plates: Set level to correct elevations, support temporarily on steel wedges, shims, or leveling nuts where shown, until the supported members are plumbed and base plate is grouted.
  - 1. Grout solid the full bearing area under base plates prior to installation of floor and/or roof decks.
  - 2. Comply with manufacturer's instructions for high strength grout. Trowel grouted surfaces smooth, splaying neatly to 45 degrees.
- F. Bolting:
  - 1. Inspect mating surfaces to insure that bolt head and nut will have full bearing and that metal plies will mate flush between bolts.
  - 2. Install bolts in matching holes. Do not distort metal or enlarge holes by drifting during assembly. Remake mismatched components to achieve tolerances indicated.
  - 3. Holes mismatched in excess of 1/8 inch will be rejected.
  - 4. Holes mismatched less than 1/8 inch may be reamed to the next larger size bolt.
  - 5. Do not enlarge holes by flame cutting or air/arc ("plasma") cutting.

6. Provide flat washer(s) at over-size holes.
  7. Provide washer at bolt head and nut where connected part is less than ¼ inch thick.
  8. Provide ASTM F436 beveled washers when the slope of the surfaces of parts in contact with the bolt head or nut is greater than 1:20.
  9. Do not install bolts with damaged threads.
  10. Threads shall commence outside of the shear plane.
  11. Machine Bolts (MB): Install and tighten to a snug condition (ST) such that laminated surfaces bear fully on one another, using an impact wrench or “full effort” of an installer using a standard spud wrench.
- G. Supports, Shoring and Bracing: Allow for erection loads and provide sufficient temporary bracing to maintain structure in safe condition, plumb, and in true alignment until completion of erection and installation of permanent bracing. Conform to requirements of all applicable laws and governing safety regulations. Resist imposed loads, including those of stored materials and equipment.
1. Provide all temporary supports, shoring and bracing necessary to achieve work of tolerances indicated.
  2. Provide all necessary temporary flooring, planking and scaffolding required for erection of steel, and support of erection machinery.
  3. Construction Loading: Do not overload the structure or temporary supports with stored materials, equipment or other loads.
  4. Maintain temporary bracing and shoring until work is complete, and longer as required to ensure stability and safety of structure.
- H. Do not make final connections until structure is aligned to meet specified tolerances.

### **3.03 ERECTION TOLERANCES**

- A. Maximum Variation From Plumb: 1/4 inch per story, non-cumulative.
- B. Maximum Offset From True Alignment: 1/4 inch.

### **3.04 FIELD QUALITY CONTROL**

- A. The independent Testing Agency will perform field quality control tests, as specified in pertinent sections of Division 01.
- B. Field Welding Inspection: Conform to all requirements of section SOURCE QUALITY CONTROL.
  1. Inspect mating surfaces.
  2. Test all materials prior to use. Use only materials meeting specified requirements.

### **3.05 ADJUSTING**

- A. Touch-up damaged finishes with compatible specified primer.
- B. Replace defective or damaged work with conforming work. Replace all defective work at Contractor's expense.

- C. Straighten materials by means that will not injure the materials.
- D. Replace defective or damaged work which cannot be corrected in the field with new work, or return defective items to the shop for repair.
- E. Architect/Engineer shall review all proposals for the repair or replacement of damaged, defective, or missing work.
- F. Pay expenses incurred by Owner for Architect/Engineer's costs for (re-)design and obtaining approvals of Authorities Having Jurisdiction (AHJ) necessitated by incomplete, inefficiently scheduled, improperly performed, defective or nonconforming work, as specified in pertinent sections of Division 01.
- G. Pay expenses due to re-testing and re-inspection necessitated by incomplete, inefficiently scheduled, improperly performed, defective or nonconforming work, as specified in pertinent sections of Division 01.

**3.06 CLEANING AND PROTECTION**

- A. Clean all surfaces upon completion of erection; leave free of grime and dirt. Remove unused materials, tools, equipment and debris from the premises and leave surfaces broomed clean.
- B. Protect work from damage by subsequent operations.

**END OF SECTION**

## SECTION 05 3000

### METAL DECKING

#### PART 1 GENERAL

##### 1.01 SUMMARY

- A. Section Includes: All material, labor, equipment and services necessary for the fabrication, erection, and completion of all metal decking as noted on drawings, including all supports for erection. The work shall include, but not necessarily be limited to the following:
1. Furnish metal decking, supports at structural steel, closures, flashing, weld plates, and necessary accessories, complete and ready to receive concrete or roofing.
  2. Install metal decking including cutting, fitting, and welding.
  3. All cutting and reinforcing of openings as required, and as laid out by other trades.
- B. Related Sections:
1. Pertinent Sections of Division 01 Specifying Quality Control and Testing Agency Services
  2. Pertinent Sections of Division 03 Specifying Concrete Construction
  3. Pertinent Sections of Division 05 Specifying Structural Steel

##### 1.02 REFERENCES

- A. California Code of Regulations, Title 24, latest adopted edition (herein noted as CBC): Chapter 19A Concrete, Chapter 22A Steel.
- B. American Iron and Steel Institute (AISI) S100 "North American Specification for the Design of Cold-Formed Steel Structural Members".
- C. Steel Deck Institute (SDI) "Design Manual for Composite Decks, Form Decks and Roof Decks".
- D. International Code Council (ICC) "Acceptance Criteria (AC) 43 - Steel Deck Roof and Floor Systems".
- E. American Society for Testing and Materials (ASTM):
1. ASTM A653 "Standard Specification for Steel Sheet, Zinc-Coated (Galvanized) or Zinc-Iron Alloy-Coated (Galvannealed) by the Hot-Dip Process".
  2. ASTM A780 "Standard Practice for Repair of Damaged and Uncoated Areas of Hot-Dip Galvanized Coatings".
  3. ASTM A1003 "Standard Specification for Steel Sheet, Carbon, Metallic- and Nonmetallic-Coated for Cold-Formed Framing Members".
  4. ASTM A1008 "Standard Specification for Steel, Sheet, Cold-Rolled, Carbon, Structural, High-Strength Low-Alloy, High-Strength Low-Alloy with Improved Formability, Solution Hardened, and Bake Hardenable".
  5. ASTM C1513 "Standard Specification for Steel Tapping Screws for Cold-Formed Steel Framing Connections".
- F. American Welding Society (AWS) "D1.3 Structural Welding Code - Sheet Steel".

### **1.03 SUBMITTALS**

- A. Shop drawings shall indicate all details of layout, fabrication and installation, location and dimension of openings, reinforcing and accessories, metal closures and flashing and type, size and location of all welds, and electromagnetically welded studs. Submit shop drawings before the start of fabrication. All details must reference detail callouts on the construction documents. Submittals that do not meet these requirements will be returned for correction without review.
- B. Current ICC reports indicating design values.
- C. Obtain reviewed structural steel shop drawings and verify all conditions before preparing shop drawings for metal decking; show all members required for support of metal decking on shop drawings for metal decking.
- D. The Contractor shall review and approve shop drawings prior to submittal. The Architect's review is of a general nature only and all responsibility for conformance with drawings and specifications and for dimensions shall remain with the Contractor.

### **1.04 QUALITY ASSURANCE**

- A. All work under this section shall be fabricated and installed in strict accordance with the incorporated documents. Refer to pertinent sections of Division 05, Structural Steel.
- B. Decking shall be installed in the field by an approved steel deck applicator with at least five years demonstrated successful experience in this type work.
- C. All installation and welding shall be done by qualified, experienced workers skilled in their trade, in conformance with established standards of good practice and the manufacturer's recommendations. All welders shall be AWS certified.

### **1.05 DELIVERY, STORAGE AND HANDLING**

- A. Protection: Steel decking sheets shall be covered and protected from weather during transit and during storage at the job site. Sheets shall not be in contact with the ground and are to have a waterproof covering.

### **1.06 JOB CONDITIONS**

- A. Coordination: The Contractor shall secure all field measurements necessary for the completion of this work. The Contractor shall be responsible for all errors of detailing and fabrication and for the correct fitting of all metal decking to each other and to their supports. Provide holes and reinforcement for mechanical and electrical penetrations.

## **PART 2 PRODUCTS**

### **2.01 MATERIALS**

- A. Deck shall be of type and by manufacturer as specified on the drawings or approved equal. All equals must meet or exceed ICC approved design values of specified decking.

- B. Steel decking and flashing shall be formed from steel sheets conforming to ASTM A653, A1003, or A1008 with a minimum yield strength of 40,000 psi. Before forming, the steel shall receive a protective metal coating of zinc conforming to ASTM A653 G60 wiped coating.
- C. Deck Sections
  - 1. Deck units shall be supplied in lengths to span over at least 3 supports where layout permits. All single span units shall have temporary mid-span shoring.
  - 2. All deck units shall be provided with either an interlocking side lap or a lapping type side lap.
  - 3. Venting Devices: Unless noted otherwise, all deck sections to receive cementitious fill shall be vented using individual separating clips of type, style and spacing recommended by deck manufacturer (space no more than 48" o.c. or a two per deck span) or built-in venting-slot formed as an integral part of deck profile. Venting slots are required only in non-cellular deck. Tabs shall be turned up into deck so that they cannot be used for hangers. Provide three rows of slots at 2'-0" on centers in three foot wide deck sections.
  - 4. Flashing and Closure Plates: Provide 16 gauge zinc coated continuous flashing for deck units as detailed, or as required, at ends and sides, at openings and at deck perimeter to contain fill. Flashing shall be detailed and installed to prevent concrete leakage.
  - 5. Reinforcing at openings and penetrations: Provide reinforcing at all openings and penetrations per PART 3.
  - 6. Galvanization Coating Repair: Zinc dust-zinc oxide primer, ASTM A780.
- D. Headed welded studs and deformed bar anchors: See section 05 1200 or 05 1100.
- E. Painted Finish: Where painted finish is specified it shall be Manufacturer's standard; baked on, rust inhibitive, applied to chemically cleaned surface.
- F. Welding Electrodes: AWS Standard E60 or equivalent or E70 or equivalent, or as specified by AWS D1.3 and Manufacturer's recommendation.

## **2.02 FABRICATION**

- A. All fabrication bevel cuts, etc. shall be done in the shop, and shall be equal to a high standard of workmanship. All deck units shall be shipped to the field in standard widths and in precut lengths so that end joints occur over supporting members.
- B. Deck section shall be cut to fit all openings, which are required. Dimensions of openings and holes required for the work of other trades will be provided by respective trades for cutting of deck.
- C. Misalignment of deck sections and cuts, short lengths, and poor workmanship shall be cause for rejection. All rejected work shall be replaced at the Contractor's expense.

## **2.03 SOURCE QUALITY CONTROL**

- A. An independent testing agency will perform source quality control tests and submit reports as specified in pertinent sections of Division 01.
- B. Steel Materials Testing:
  - 1. No Testing Required for Materials as follows:

- a. Materials identified in accordance with CBC 2203A.1 and ASTM A6. (heat number, grade stencil, etc.)
- b. Materials accompanied by certified mill test reports for all members, and Contractor's affidavit confirming that all materials used in the fabrication and shipped to the job are from the grades specified and match the certificates supplied.
2. Unidentified steel: Where identification of materials by heat number or mill reports cannot be made, testing agency shall test unidentified deck.

### PART 3 EXECUTION

#### 3.01 INSTALLATION

- A. The steel deck units shall be placed on the supporting framework, aligned, and adjusted to final position before being permanently fastened. Each unit shall be brought to proper bearing on the supporting beams. If the supporting beams are not properly aligned or sufficiently level to permit proper bearing of the steel units, the Contractor shall notify the Architect prior to taking corrective action to insure properly aligned work.
- B. Deck units shall be placed in straight alignment for the entire length of run with close registration of the cells of one unit with those of abutting and adjoining units. Provide a minimum of 2 inch end bearing at abutting deck units. Continuous deck units shall be provided with a minimum of 3" bearing, all butt joints shall be "tight" (no gap).
- C. Deck units shall not be placed on supporting members until all structural steel is completely installed, plumbed, and connections are completed.
- D. Welding:
  1. Steel deck units shall be fastened to the steel framework by the arc welding process. Welds shall be free of sharp points or edges.
  2. All welding shall be done by competent experienced welders, thoroughly familiar with the metal to be welded, and certified for welding of light gauge metal.
  3. Deck sheets shall be welded to the supporting member and to each other with welds as listed below unless otherwise noted on the drawings.
    - a. End and intermediate support perpendicular to deck flutes: 3/4" diameter spot weld at each flute.
    - b. Side joints between individual deck units with side interlock joint: 1-1/2" top or side seam weld at 12" on center. Button punch at 36" on center before welding to draw units together.
    - c. Side joints between individual deck units where concrete is placed on the metal deck is to be button punched at 36" on center.
    - d. Boundary deck units to parallel supports and interior deck units to parallel framing supports 3/4" diameter spot weld or 3/8" x 1-1/4" arc seam weld at 12" on center.
  4. Weld all closure angles and plates with 3/4" diameter spot weld or 3/8"x 1-1/4" arc seam welds at 18" apart.
  5. Headed welded studs and deformed bar anchors: See section 05 1200 or 05 1100.
- E. Screw Attachment: When called for on the drawings, painted roof deck is to be attached with galvanized #12 hex head metal screws with neoprene washers at flutes and at 24" on center at side laps and at 12" on center at perimeter side laps. Screws and metal washers shall be painted to match deck color where decking is a painted finish surface.



- F. Decking shall be installed in a continuous operation to avoid delays in the construction.
- G. Opening reinforcement shall be as detailed on the drawings. Cutting of holes other than those detailed on the drawings shall be done only as specifically approved by the Architect. Holes not shown on structural drawings shall be cut and reinforced in accordance with details on drawings. In general, reinforcing is not required for holes less than 4" in diameter. Holes at column penetrations shall be reinforced as any other hole. See details on drawings for other requirements.
- H. Leave slag in place at welds to be covered by concrete. Elsewhere, remove slag to bright metal and touch up all welds and field cut edges with galvanization repair primer.
- I. Field Finishing:
  - 1. Permanently exposed galvanized surfaces requiring welding shall be thoroughly cleaned by wire brushing after welding and then touched up with galvanization repair primer.
  - 2. After erection all damaged surfaces shall be primed.
  - 3. Painted deck shall be touched up with primer and matching paint.

### **3.02 FIELD QUALITY CONTROL**

- A. Welding Inspection:
  - 1. Testing Agency shall inspect and certify all structural welds. Submit certification to the Architect/Engineer for review and the Building Official for approval.
  - 2. Welder Qualifications: Welding inspector shall verify that all the welders are properly qualified prior to steel fabrication and state the qualifications of each welder in the welding inspection report.
  - 3. Welding Inspection:
    - a. Welding Inspector shall check all welds, materials, equipment and procedures.
    - b. Welding Inspector shall provide reports certifying the welding is as required and has been done in conformity with the plans, specifications and codes.
    - c. Periodic inspection per CBC is acceptable.

### **3.03 DEFECTIVE WORK**

- A. All work not in conformance with these specifications and/or generally accepted standards of the trade, will be deemed defective by the Architect and will be rejected. All work that is defective shall be corrected or replaced as directed by the Architect. Corrections redesign, and replacement of defective work shall be at Contractor's expense.

### **3.04 CLEANING**

- A. After erection, all surfaces shall be cleaned and left free of all grime and dirt. Decking shall be cleaned with solvents, if necessary to provide a surface, which will readily bond with concrete fill and direct-to-steel fireproofing. Remove unused materials, tools, scaffolding and debris from the premises and leave the area broom clean.

**END OF SECTION**

## SECTION 05 4000

### COLD-FORMED METAL FRAMING

#### PART 1 GENERAL

##### 1.01 SUMMARY

A. Section Includes:

1. All design and other services, material, labor and equipment as necessary for the fabrication, erection and completion of all cold formed metal framing including all bracing and shoring required for erection, miscellaneous metal, and related work.

B. Related Sections:

1. Pertinent Sections of Division 01 Specifying Quality Control and Testing Agency Sections
2. Pertinent Sections of Division 05 Specifying Structural Steel.

##### 1.02 REFERENCE STANDARDS

- A. California Code of Regulations, Title 24, latest adopted edition (herein noted as CBC): Chapter 22A Steel.
- B. American Iron and Steel Institute (AISI) S100 "North American Specification for the Design of Cold-Formed Steel Structural Members".
- C. AISI S200 "North American Standard for Cold-Formed Steel Framing – General Provisions".
- D. AISI D100 "Cold-Formed Steel Design Manual.
- E. American Welding Society (AWS) D1.3 "Structural Welding Code – Sheet Steel"
- F. American Society for Testing and Materials (ASTM):
  1. ASTM A307 "Standard Specification for Carbon Steel Bolts, Studs, and Threaded Rod 60000 PSI Tensile Strength".
  2. ASTM A606 "Standard Specification for Steel, Sheet and Strip, High-Strength, Low-Alloy, Hot-Rolled and Cold-Rolled, with Improved Atmospheric Corrosion Resistance".
  3. ASTM A653 "Standard Specification for Steel Sheet, Zinc-Coated (Galvanized) or Zinc-Iron Alloy-Coated (Galvannealed) by the Hot-Dip Process".
  4. ASTM A780 "Standard Practice for Repair of Damaged and Uncoated Areas of Hot-Dip Galvanized Coatings".
  5. ASTM A1003 "Standard Specification for Steel Sheet, Carbon, Metallic- and Nonmetallic-Coated for Cold-Formed Framing Members".
  6. ASTM A1008 "Standard Specification for Steel, Sheet, Cold-Rolled, Carbon, Structural, High-Strength Low-Alloy, High-Strength Low-Alloy with Improved Formability, Solution Hardened, and Bake Hardenable".
  7. ASTM A1011 "Standard Specification for Steel, Sheet and Strip, Hot-Rolled, Carbon, Structural, High-Strength Low-Alloy, High-Strength Low-Alloy with Improved Formability, and Ultra-High Strength".

8. ASTM C645 "Standard Specification for Nonstructural Steel Framing Members".
  9. ASTM C754 "Standard Specification for Installation of Steel Framing Members to Receive Screw-Attached Gypsum Panel Products".
  10. ASTM C955 "Standard Specification for Load-Bearing (Transverse and Axial) Steel Studs, Runners (Tracks), and Bracing or Bridging for Screw Application of Gypsum Panel Products and Metal Plaster Bases".
  11. ASTM C1007 "Standard Specification for Installation of Load Bearing (Transverse and Axial) Steel Studs and Related Accessories".
  12. ASTM C1513 "Standard Specification for Steel Tapping Screws for Cold-Formed Steel Framing Connections".
- G. The Society for Protective Coatings (SSPC) SSPC-Paint20 "Zinc-Rich Coating (Inorganic or Organic)".

### **1.03 SUBMITTALS**

- A. Manufacturer's Literature:
1. Descriptive data illustrating cold-formed framing system components including framing members, fasteners, and accessories, including ICC-ES reports.
  2. Erection instructions containing sequence of operations.
- B. Samples: Provide adequate samples of unidentified material to the Owner's Testing Laboratory for testing purposes.

### **1.04 QUALITY ASSURANCE**

- A. Erector Qualifications:
1. Minimum of three years successful experience on comparable cold-formed metal framing projects.
  2. Welders qualified in accordance AWS D1.3.
- B. Cold form carbon and low alloy steel used for structural purposes shall be identified per CBC Section 2202A.1.
- C. Welding inspections shall conform to AWS D1.3 and CBC 1705A.2.

## **PART 2 PRODUCTS**

### **2.01 ACCEPTABLE MANUFACTURERS**

- A. Members of the "Steel Stud Manufacturers Association (SSMA)" with products meeting ICC-ES ESR-3064P. Members of the "Certified Steel Stud Association (CSSA)" with products meeting ICC-ES ESR-3016.

### **2.02 MATERIALS**

- A. Steel Framing System:
1. All stud and/or joist framing members shall be of the type & size as shown on the plans and reviewed shop drawings.

2. All runner and end tracks, bridging, and non-load bearing studs shall be of the type & size shown on the plans.
  3. All studs, joists, and tracks 54 mils or greater in thickness shall be formed from steel that corresponds to the requirements of ASTM A1003 (Grade ST50H or ST50L) with a minimum yield of 50,000 psi.
  4. All studs, joists, track, bridging, U-channel, (hat) furring (F) channels, and accessories 43 mils or thinner in thickness shall be formed from steel that corresponds to the requirements of ASTM A1003 (Grade ST33H or ST33L) with a minimum yield of 33,000 psi.
  5. All stud and joist components shall be formed from steel having a minimum G-60 galvanized coating (equivalent coatings such as "G60e" are not acceptable), unless noted otherwise, or shall be primed with paint meeting the performance requirements SSPC-Paint20, where noted.
  6. Welding Electrodes: Shall conform to AWS D1.3. E60 or E70. Touch up all welds with zinc-rich paint in compliance with ASTM A780.
  7. Primer: SSPC-Paint20.
- B. Screws shall be per ASTM C1513.
- C. Machine bolts shall be per ASTM A307.
- D. Powder Driven Pins (PDP): Hilti X-U, ICC ESR-2269. For use only where specified by the drawings.
- E. Accessories: Cold-formed metal framing manufacturer's standard.

### **2.03 FABRICATION**

- A. Form members to manufacturer's standard shapes meeting design criteria.
- B. Cut right angle connections of framing components to fit squarely against abutting members.
- C. Prime un-galvanized steel to 1.5 mil (0.038) minimum dry film thickness.

## **PART 3 EXECUTION**

### **3.01 ERECTION**

- A. Clean surfaces that will be in contact after assembly.
- B. Position members plumb, square and true to line.
- C. Seat studs squarely in track with stud web and flange abutting track web with maximum 1/8 inch gap.
- D. Connect members together by welding and/or fasteners in accordance with the drawings.
- E. Do not splice studs. Provide "headers" and "trim studs" at openings as required. Studs shall be securely attached to tracks at all exterior walls except as noted below.
- F. Provide for expansion and contraction between floors at solid wall sections of two stories or more by providing a slip joint between stud and track at one end. This connection shall be capable of transmitting lateral loads to the structure.

- G. Provide and install bridging, fire blocking, etc. per manufacturer's recommendations, the plans, and code requirements.
- H. Perform welding in accordance with AWS D1.3
- I. Remove erection bolts and screws used in welded construction.
- J. Do not use gas cutting for field correction of fabrication without concurrence of Architect/Engineer.
- K. Touch-up field connections and breaks in shop coating with same primer used for shop priming.

### **3.02 DEFECTIVE WORK AND MATERIALS**

- A. Work found to be defective, missing or damaged shall be immediately replaced with proper work. Such replaced work and the inspection for same shall be at the expense of the Contractor.
- B. Straightening of any materials, if necessary, shall be done by a process and in a manner that will not injure the materials, and which is approved by the Architect. Sharp kinks or bends shall be cause for rejection. Heating will not be allowed.
- C. If defects or damaged work cannot be corrected in the field, the material shall be returned to the shop or new parts furnished, as the Architect directs; the Contractor shall replace all work at his own expense.

### **3.03 CLEANING**

- A. After erection, all surfaces shall be cleaned and left free of all grime and dirt. Remove unused materials, tools, equipment and debris from the premises and leave broom clean.

**END OF SECTION**

**SECTION 05 5000**  
**METAL FABRICATIONS**

**PART 1 GENERAL**

**1.01 SECTION INCLUDES**

- A. All miscellaneous metal fabrications not classified as structural steel.
- B. Iron and steel fabrications for wood or metal framing, including bracing.
- C. Inserts and anchorages: Furnish only, inserts and anchoring devices for installation of miscellaneous metal work. Provide setting drawings, templates, instructions and directions for installation of anchorage devices. Coordinate delivery with other work.
- D. Miscellaneous nonferrous metal items not specified under other sections.
- E. Fabrication and installation of metal work, including shop and field welding, drilling, cutting, connecting and shop painting.
- F. Miscellaneous shapes, plates, angles, clip angles, supports, bolts, and specialty iron and steel items indicated and as necessary to complete the work, including, but not limited to, the following:
  - 1. Metal handrails, railings, guardrails.
  - 2. Pipe sleeves.
  - 3. Fences, gates and enclosures.
  - 4. Miscellaneous sunshades, brackets, canopies.
  - 5. Steel pipe rain water leaders and brackets.
  - 6. Vent well gratings and angles.
  - 7. Decorative grilles, trusses, and architectural features.
  - 8. Pipe bollards.

**1.02 RELATED REQUIREMENTS**

- A. Section 03 3000 - Cast-in-Place Concrete: Placement of metal fabrications in concrete.
- B. Division 06 Sections: Installation of anchorage and support items. Framing connectors for wood framing.
- C. Section 05 1100 - Structural & Miscellaneous Steel.
- D. Section 07 6200 - Sheet Metal Flashing and Trim
- E. Section 08 1113 - Hollow Metal Doors and Frames
- F. Section 08 3613 - Overhead Sectional Doors
- G. Section 08 7100 - Door Hardware
- H. Refer to pertinent sections of Division 09 for interior and exterior painting
- I. Other sections requiring metal fabrications or referencing this section for fabrication and installation.
- J. Pertinent Division 22, 23 and 26 sections: Sleeves and inserts for mechanical piping and ducts, and electrical conduit, bracing and support of mechanical and electrical equipment.
- K. Pertinent sections of Division 33 specifying storm drain piping requiring connection to rain water leaders.

### 1.03 REFERENCE STANDARDS

- A. ASTM A36/A36M - Standard Specification for Carbon Structural Steel; 2014.
- B. ASTM A53/A53M - Standard Specification for Pipe, Steel, Black and Hot-Dipped, Zinc-Coated, Welded and Seamless; 2012.
- C. ASTM A123/A123M - Standard Specification for Zinc (Hot-Dip Galvanized) Coatings on Iron and Steel Products; 2015.
- D. ASTM A283/A283M - Standard Specification for Low and Intermediate Tensile Strength Carbon Steel Plates; 2013.
- E. ASTM A307 - Standard Specification for Carbon Steel Bolts, Studs, and Threaded Rod 60 000 PSI Tensile Strength; 2014.
- F. ASTM A500/A500M - Standard Specification for Cold-Formed Welded and Seamless Carbon Steel Structural Tubing in Rounds and Shapes; 2013.
- G. ASTM A653/A653M - Standard Specification for Steel Sheet, Zinc-Coated (Galvanized) or Zinc-Iron Alloy-Coated (Galvannealed) by the Hot-Dip Process; 2015.
- H. ASTM A1011/A1011M - Standard Specification for Steel, Sheet and Strip, Hot-Rolled, Carbon, Structural, High-Strength Low-Alloy, High-Strength Low-Alloy with Improved Formability, and Ultra-High Strength; 2014.
- I. ASTM F3125/F3125M - Standard Specification for High Strength Structural Bolts, Steel and Alloy Steel, Heat Treated, 120 ksi (830 MPa) and 150 ksi (1040 MPa) Minimum Tensile Strength, Inch and Metric Dimensions; 2015a.
- J. ASTM E 935 - Test Methods for Performance of Permanent Metal Railing Systems and Rails for Buildings.
- K. AHDGA - American Hot Dip Galvanizing Association.
- L. NAAMM MBG 531 - Metal Bar Grating Manual; The National Association of Architectural Metal Manufacturers; 2000 (ANSI/NAAMM MBG 531).
- M. AWS A2.4 - Standard Symbols for Welding, Brazing, and Nondestructive Examination; 2012.
- N. AWS D1.1/D1.1M - Structural Welding Code - Steel; 2015.
- O. SSPC-Paint 15 - Steel Joist Shop Primer/Metal Building Primer; 1999 (Ed. 2004).
- P. SSPC-Paint 20 - Zinc-Rich Primers (Type I, "Inorganic," and Type II, "Organic"); 2002 (Ed. 2004).
- Q. SSPC-SP 2 - Hand Tool Cleaning; 1982 (Ed. 2004).
- R. SSPC (PM2) - Painting Manual, Vol. 2, Systems and Specifications; Steel Structures Painting Council; 1995.

### 1.04 SUBMITTALS

- A. See Section 01 3300 - Submittals, for submittal procedures.
- B. Shop Drawings: Indicate profiles, sizes, connection attachments, reinforcing, anchorage, size and type of fasteners, and accessories. Include erection drawings, elevations, and details where applicable.
  - 1. Include details of cuts, connections, camber, holes, and other pertinent data.

2. Indicate welded connections using standard AWS A2.4 welding symbols. Indicate net weld lengths, sizes and types.
- C. Product Data:
  1. Catalog cuts for all manufactured items demonstrating compliance with specified requirements.
  2. Structural steel primer paint.
- D. Welding procedures: For welding structural steel as required in accordance with AWS D1.1, submit prequalified joints.
- E. Certification: Copy of approved fabricator's license.
- F. Manufacturer's data: Submit certified copies of the following prior to any fabrication. Include laboratory test reports and other data as required to show compliance with these specifications, including specified standards.
  1. Structural steel, including certified copies of mill reports covering the chemical and physical properties.
  2. Unfinished bolts and nuts.

#### **1.05 SUBMITTALS FOR RECORD**

- A. Section 01 3300 - Submittals: Procedures for submittals. Architect will not review these submittals.
- B. Welders' Certificates: Submit certification for welders employed on the project, verifying AWS qualification within the previous 12 months.

#### **1.06 QUALITY ASSURANCE**

- A. Design criteria: Design, fabricate and erect miscellaneous metal items complete, in accord with AISC's Design, Fabrication and Erection of Structural Steel for Buildings.
- B. Coordinate the Work under provisions of pertinent sections of Division 01.
- C. Welders:
  1. Qualify welding processes and welding operators in accordance with AWS "Standard Qualification Procedure".
  2. Provide certification that welders to be employed in the work have satisfactorily passed AWS qualification tests within the previous 12 months, and are qualified in the State of California.
- D. Welding Inspection: All structural welding shall be specially inspected according to CBC 1704A and DSA IR-17-3 except as otherwise provided below.
  1. Special inspection shall not be required if welding is done in an approved fabricator's shop licensed in accordance with CBC 1704A.

#### **1.07 PRODUCT HANDLING**

- A. Comply with pertinent provisions of Section 01 6000.
- B. Deliver anchor bolts, anchorage devices, sleeves and inserts, which are to be incorporated into other work in ample time to avoid delay.
- C. Store materials to permit easy access for inspection and identification. Store steel materials off the ground, using pallets, platforms or other supports. Protect steel members, package materials and identifications from deterioration.



- D. Store material to prevent twisting, bending, or abrasion, and to provide ventilation. Slope metal sheets to ensure drainage.
- E. Prevent contact with materials which may cause discoloration or staining. Clean materials which are discolored or stained.
- F. Replacements: In the event of damage, immediately make repairs and replacements necessary to the approval of the Architect and Division of the State Architect without change in contract amount or time.

## **PART 2 PRODUCTS**

### **2.01 MATERIALS**

- A. General: Furnish new tested stock complying with reference specifications.
- B. Steel Sections: ASTM A36/A36M.
- C. Steel Tubing: Hot formed, welded or seamless, ASTM A 501, or cold-formed, ASTM A500, Grade B cold-formed.
- D. Plates: ASTM A283/A283M.
- E. Pipe: ASTM A53/A53M, Grade B Schedule 40, black and hot-dip galvanized finish, as indicated.
- F. Slotted Channel Framing: ASTM A653/A653M, Grade 33.
- G. Slotted Channel Fittings: ASTM A1011/A1011M.
- H. Bars and bar-size shapes: ASTM A 663, Grade 65, or ASTM A 36.
- I. Sheets: ASTM A 446 with zinc-coating in accord with ASTM A 525, G-90.
- J. Hot-rolled carbon steel bars and bar-size shapes: ASTM A 575, Grade as selected by fabricator.
- K. Steel plate, checkered pattern: Steel with checkered (diamond) pattern, galvanized, ASTM A 525, coating designation G90.
- L. Carbon steel sheets and strips:
  - 1. Hot-rolled: ASTM A 568 and ASTM A 569, pickled and oiled.
  - 2. Cold-rolled: ASTM A 366.
  - 3. Galvanized sheets: ASTM A 525, or A 526 with G-90 zinc coating
- M. Masonry anchorage devices: Expansion shields, FS FF-S-325.
- N. Toggle bolts: Tumble-wing type, FS FF-B-588, type, class and style as required.
- O. Fasteners: Select fasteners for type, grade and class required for the installation of miscellaneous metal items, compatible for material in contact. Provide hot-dipped galvanized at exterior exposures or when in contact with pressure-treated wood materials..
- P. Bolts, Nuts, and Washers: ASTM F3125/F3125M, Type 1, plain.
  - 1. Standard bolts and nuts: Regular square or hexagon head type, ASTM A 307, Grade A.
  - 2. Lag bolts: Square head type, galvanized.
  - 3. Machine screws: Cadmium-plated steel, ASTM F 468 and FS FF-S-92.
  - 4. Plain washers: ANSI B18.22.1 and FS FF-W-92.

5. Anchors: Manufactured by Ramset Fastening System Division, Olin Corp., Rawlplug Co., Diamond Division, General Cable, Hilti or ITT Phillips Drill Division. Provide type best suited for intended application and indicate on shop drawings.
  6. Lock washers: FS FF-W-84, helical spring type carbon steel.
  7. Anchor Bolts: ASTM A307.
- Q. Brackets, flanges and anchors: Cast or formed metal of the same type material and finish as supported rails, unless otherwise indicated.
- R. Concrete inserts: Threaded or wedge type, galvanized ferrous castings, either malleable iron ASTM A 47 or cast steel ASTM A 27. Provide bolts, washers and shims as required, hot-dip galvanized, ASTM A 153.
- S. Welding Materials: AWS D1.1; type required for materials being welded. Comply with AWS D1.1, D1.3 and CBC Title 24 Part 2.
- T. Non-shrink Grout for Guardrail post inserts: Masterflow 928 Grout by Master Builders or equal.
- U. Zinc-rich paint (cold galvanizing): ZRC-221 by ZRC WorldWide, or equal.
- V. Shop and Touch-Up Primer: SSPC-Paint 15, complying with VOC limitations of authorities having jurisdiction, compatible with intermediate and finish coatings specified in other Sections.
- W. Touch-Up Primer for Galvanized Surfaces: ZRC Zero-VOC by ZRC Worldwide, or equal, compatible with intermediate and finish coatings specified in other Sections

## 2.02 FABRICATION

- A. Field Measurements: Take field measurements prior to preparation of shop drawings and fabrication, where possible, to ensure proper fitting of the work. Allow for trimming and fitting where field conditions preclude accurate measurements or where final dimensions cannot be established prior to fabrication.
- B. Fit and shop assemble items in largest practical sections, for delivery to site.
1. Minimize field splicing and site assembly. Disassemble only to the extent necessary for shipping and handling limitations. Clearly mark units for reassembly and coordinated installation.
  2. Complete assembly, including welding, before start of finishing operations. Provide finish surfaces of members exposed in the final structure free of markings, burrs, and other defects.
  3. Use materials and items necessary to complete the work, using the best materials and methods ordinarily used for this type of work whether explicitly specified, indicated and detailed or not.
- C. Fabricate items with joints tightly fitted and secured.
- D. Machine-roll components or elements required to be curved or radiused. Do not field bend or "walk-down". Provide curves true to indicated dimensions, minimizing joints; segmented fabrication not allowed unless specifically noted.
- E. Continuously seal joined members by continuous welds.
1. Grind exposed joints flush and smooth with adjacent finish surface. Make exposed joints butt tight, flush, and hairline. Ease exposed edges to small uniform radius.

2. Exposed Mechanical Fastenings: Flush countersunk screws or bolts; unobtrusively located; consistent with design of component, except where specifically noted otherwise.
  3. Supply components required for anchorage of fabrications. Fabricate anchors and related components of same material and finish as fabrication, except where specifically noted otherwise.
- F. Use only materials smooth and free of blemishes including pitting, seam marks, roller marks, trade names and roughness.
- G. Fabricate steel members in accordance with drawings and as recommended by A.I.S.C. Verify all dimensions with field conditions prior to fabrication.
1. Clean, prepare and shop-prime steel members. Do not prime surfaces to be field welded or in direct contact with concrete.
  2. Galvanizing: ASTM A153, ASTM A123; all steel exposed to weather.
  3. Cutting and drilling: Provide holes for fabrication and for attachment of work specified elsewhere. Countersink holes for bolts and screws.
- H. Welding: Comply with the AWS Structural Welding Code, and with the following:
1. Welds shall be free from excessive oxides, nonmetallic inclusions, and gas pockets.
  2. Welds shall be uniform in section, smooth in weld metal, feather edged, without overlaps.
  3. Surfaces to be welded shall be free from loose scale, rust, paint, or other foreign matter.
  4. Tack welds located in way of design welds shall be melted out when encountered in final welding, or shall be thoroughly fused in with final weld.
  5. Use proper care and procedures to minimize locked-in stress and distortion.
  6. Welder qualification requirements, welding procedure and welding electrodes shall conform to CBC 2204A and most recent editions of AWS D1.1, D1.3; CBC IR-17-3.

### 2.03 HANDRAILS and RAILINGS

- A. Steel pipe or tube handrails and railings: Fabricate to dimensions and details shown, with welded joints ground smooth and flush. Hot-dipped galvanized at exterior locations.
1. Fabricate and install to comply with requirements of ASTM E985 for structural performance based on testing performed in accordance with ASTM E894 and E935.
  2. Structural Performance: Handrails and top rails shall withstand the following structural loads:
    - a. Concentrated Load: 200 lbs., applied non-concurrently, in any direction.
    - b. Uniform Load: 50 lb/ft. applied simultaneously in both vertical and horizontal direction.
    - c. Concentrated loads and uniform loads need not be assumed to act concurrently.
  3. Picket and grille spacing, fences adjacent to Playground areas: Fabricate fence pickets and grillework so that all openings in the finished fence are less than 3.5 inches or greater than 9 inches, including the opening between the bottom rail and the finish grade.
  4. Shop fabricate to greatest extent possible.
  5. Interconnect railing members by butt-welding or by welding with internal connectors, unless otherwise indicated.
  6. At tee and cross intersections, notch ends of intersection members to fit contour of pipe and weld all around.
  7. Form changes in direction of railing members by radius bends, maintaining cylindrical cross-section of pipe throughout bend without buckling, twisting, cracking or otherwise deforming exposed surface of pipe.
  8. Provide galvanized inserts for concrete paving for attachment of rails, where occurs.

## 2.04 STEEL PIPE RAIN WATER LEADERS (RWL)

- A. Steel pipe or tube rain water leaders: Fabricate to dimensions and details shown, with welded joints ground smooth and flush, hot-dipped galvanized.
  - 1. Structural Performance: Rain water leaders shall withstand the following structural loads:
    - a. Concentrated Load: 200 lbs., applied non-concurrently, in any direction.
    - b. Uniform Load: 50 lb/ft. applied simultaneously in both vertical and horizontal direction.
    - c. Concentrated loads and uniform loads need not be assumed to act concurrently.
  - 2. Shop fabricate to greatest extent possible.
  - 3. Interconnect rainwater leader members by butt-welding or by welding with internal connectors, unless otherwise indicated.
  - 4. At intersections and changes of direction, notch ends of intersection members to fit contour of pipe and weld all around. Seal weld all joints water-tight.
  - 5. Form changes in direction of water flow by mitered connections, maintaining cylindrical cross-section of pipe throughout bend without buckling, twisting, cracking or otherwise deforming exposed surface of pipe.
  - 6. Provide support brackets of sizes and types indicated and with configurations required to suit substrates and framing spacing.

## 2.05 FINISHES - STEEL

- A. Hot-dip galvanize steel items fully or partially exposed to exterior conditions or to wet environments such as locker rooms, food service, custodial or toilet rooms. Prime paint steel items in all other locations.
  - 1. Exceptions: Galvanize items to be embedded in concrete or masonry.
  - 2. Exceptions: Do not prime surfaces in direct contact with concrete, where field welding is required, and items to be covered with sprayed fireproofing.
- B. Prepare surfaces to be primed in accordance with SSPC-SP2 SSPC SP-3, "Power Tool Cleaning", minimum. Remove oil, grease and similar contaminants in accordance with SSPC SP-1 "Solvent Cleaning".
  - 1. Review coating systems specified in other Sections. Provide level of substrate surface finish required or recommended by coating manufacturer for each specified system.
- C. Prime Painting: One coat, primer in accordance with the coating manufacturer's printed instructions. Select products compatible with coating systems specified in other Sections.
- D. Galvanizing of Non-structural Items: Galvanize after fabrication to ASTM A123/A123M requirements.

## 2.06 FABRICATION TOLERANCES

- A. Squareness: 1/8 inch (3 mm) maximum difference in diagonal measurements.
- B. Maximum Offset Between Faces: 1/16 inch (1.5 mm).
- C. Maximum Misalignment of Adjacent Members: 1/16 inch (1.5 mm).
- D. Maximum Bow: 1/8 inch (3 mm) in 48 inches (1.2 m).
- E. Maximum Deviation From Plane: 1/16 inch (1.5 mm) in 48 inches (1.2 m).

### **PART 3 EXECUTION**

#### **3.01 EXAMINATION**

- A. Verify that field conditions are acceptable and are ready to receive work. Correct conditions detrimental to the proper and timely performance of this work before proceeding with installation. Commencement of work indicates acceptance of substrates.

#### **3.02 PREPARATION**

- A. Clean and strip primed steel items to bare metal where site welding is required.
- B. Supply setting templates to the appropriate entities for steel items required to be cast into concrete or embedded in masonry.

#### **3.03 INSTALLATION**

- A. Install items plumb and level, measured from established lines and levels, accurately fitted, free from distortion or defects.
- B. Provide temporary bracing or anchors in formwork for items which are to be built into concrete or similar construction.
- C. Provide for erection loads, and for sufficient temporary bracing to maintain true alignment until completion of erection and installation of permanent attachments.
- D. Fastening to In-Place Construction: Provide anchorage devices and fasteners where necessary for securing miscellaneous metal items to in-place construction; including threaded fasteners for concrete inserts, toggle bolts, through-bolts, lag bolts, wood screws, and other connectors as required.
- E. Cutting and fitting:
  - 1. Perform cutting, drilling and fitting required for installation of miscellaneous metal items. Fit exposed connections accurately together to form tight hairline joints.
  - 2. Weld connections which are not to be left as exposed joints, but cannot be shop welded because of shipping size limitations.
  - 3. Do not weld, cut or abrade the surfaces of exterior units which have been hot dip galvanized after fabrication, and are intended for bolted or screwed field connections.
- F. Field weld components as indicated on drawings or as required to assemble shop-fabricated work on site. If field-welding is not specifically indicated on drawings, option is the Contractor's for efficient assembly.
- G. Perform field welding in accordance with AWS D1.1/D1.1M.
- H. Obtain approval prior to site cutting or making adjustments not scheduled.
- I. Immediately after erection, clean and prime welds, abrasions, and surfaces not shop primed or galvanized, except surfaces to be in contact with concrete with the same materials used for shop finishing.
- J. Rainwater Leader Installation: Plumb units in each direction.
  - 1. Accurately locate rainwater leaders in proximity to underground storm drain connections. Coordinate with work of other sections for accurate placement and alignment of the work.
  - 2. Secure Rainwater Leaders to walls using wall brackets. Secure brackets and return fittings as follows:
    - a. Wood framing: Stainless steel lag screws.

- b. Steel Framing: Stainless steel threaded self-tapping screws.
  - c. Masonry or Concrete: Stainless steel threaded tap-in anchor bolts.
  - d. Structural Steel column or member: Weld.
- 3. Locate supporting brackets at approximately equal intervals, not less than 5'-4" on center, not less than 18 inches from ends, with a minimum of three per supports per unit, and additional brackets within 18 inches of change in direction or substrate mounting material.
  - 4. Connect rain water leaders to storm drains with water-tight connection.

#### **3.04 TOLERANCES**

- A. Maximum Variation From Plumb: 1/4 inch (6 mm) per story, non-cumulative.
- B. Maximum Offset From True Alignment: 1/4 inch (6 mm).
- C. Maximum Out-of-Position: 1/4 inch (6 mm).

#### **3.05 PROTECTION**

- A. Protect finished work from damage until acceptance by Owner.
- B. Repair and replacement: In the event of damage, immediately make repairs and replacements necessary to satisfaction of Architect without change in contract sum or time.

#### **3.06 CLEAN-UP**

- A. When work of this section has been completed, and at such other times as may be directed, remove all trash, debris, surplus materials, tools and equipment from site.
- B. Comply with pertinent requirements of Division 01 section specifying Contract Closeout.

**END OF SECTION**

**SECTION 05 5133**  
**ACCESS LADDERS**

**PART 1 GENERAL**

**1.01 SECTION INCLUDES**

- A. Fixed aluminum access ladders and accessories. All components shall be products of a single manufacturer.
  - 1. Safety posts

**1.02 RELATED SECTIONS**

- A. Section 07 7200 - Roof Accessories: Manufactured curbs and roof hatches.
- B. Pertinent sections specifying ceiling finishes and roof construction.

**1.03 SUBMITTALS**

- A. See Section 01 3300 - Submittals, for submittal procedures.
- B. Product Data: Provide manufacturer's product data, installation instructions and attachment methods.
- C. Certificate: Provide documentation that ladder safety system products of this section meet or exceed cited 29 CFR 1910.28, 29 CFR 1910.29, ANSI/ASSP Z359.16, and ANSI A14.3 requirements.
- D. Shop Drawings: Indicate materials, component profiles, wall and floor fastening methods, jointing details, finishes, and accessories.
- E. Warranty: Submit manufacturer warranty and ensure that forms have been completed in Owner's name and registered with manufacturer.

**1.04 QUALITY ASSURANCE**

- A. Provide work meeting requirements of ANSI A14.3 and OSHA standards, State of California.

**1.05 DELIVERY, STORAGE, AND PROTECTION**

- A. Deliver products to project site in original containers.
- B. Store products under cover and elevated above grade.

**1.06 WARRANTY**

- A. See Section 01 7000 - Closeout, for additional warranty requirements.
- B. Correct defective Work within a one year period after Date of Substantial Completion.
- C. Correct defective Work within a one year period after Date of Substantial Completion.

**PART 2 PRODUCTS**

**2.01 PERFORMANCE REQUIREMENTS**

- A. Structural Performance of Aluminum Ladders: Aluminum ladders, including landings, shall withstand the effects of loads and stresses within limits and under conditions set forth in ANSI A14.3.

## 2.02 MANUFACTURERS

- A. Products by O'Keefe's Inc. Architectural Building Products, Brisbane, CA; tel: (888) 653-3333; web: www.okeeffes.com.
- B. ALACO Ladder Co.
- C. Substitutions: See Section 01 6000 - Product Requirements.

## 2.03 MANUFACTURED UNITS

- A. Model 500, Standard Duty Channel Rail Fixed Access Ladder.
- B. Model 503, Tubular Rail Low Parapet Access Ladder with Platform and Return and AB - Alternative Bottom support.

## 2.04 COMPONENTS

- A. Aluminum ladders, brackets, and accessories shall be of extruded aluminum, 6063-T5 alloy or other alloy and temper as selected by manufacturer to provide required results.
- B. Rungs shall be of not less than 1-1/4 inches in section and 18-3/8" long. Rungs shall be squared and serrated so as to provide maximum grip and foot traction.
- C. Channel side rails shall be sections of extruded aluminum of 3" in width and a minimum extrusion wall thickness of 0.125 inch.
- D. The ladder surfaces shall be smooth, clean and free of burrs or sharp edges.
- E. Design Ladders and accessories to carry a minimum 1000 pound concentrated live load.
- F. Fasteners: Provide Type 304 stainless-steel fasteners for fastening aluminum. Select types appropriate to application, sizes and spacing as detailed and to resist imposed loads.

## 2.05 FINISHES

- A. Clear anodic finish, AA-M10C22A41 Mechanical Finish as fabricated, Architectural Class I, clear coating 0.018 mm or thicker.

## 2.06 ACCESSORIES

- A. Mounting bracket shall be of 1/8 inch thick aluminum extrusions, attached to ladder side rails with self locking stainless steel fasteners per manufacturers written instructions.
  - 1. Provide mounting brackets in locations indicated and to meet manufacturers requirements.
  - 2. Provide additional intermediate support brackets to maintain minimum required spacing as determined by ladder height.
  - 3. Provide AB - Alternative Bottom support for full wall mounting at all locations where necessary to avoid penetration of roofing by ladder rung supports.
- B. Retractable ladder safety post: Stainless steel safety post attached at the top of the access ladder to the roof per manufacturer's written instructions. Post shall extend minimum 30 inches at full extension above the highest adjacent level of the roof outside the hatch. Comply with ANSI 14.3 and OSHA requirements.
  - 1. Manufacturer: O'Keefe's Safety Post.



### **PART 3 EXECUTION**

#### **3.01 EXAMINATION**

- A. Verify that blocking has been properly installed in the correct location in wall framing prior to close-in.
- B. Verify that all finishes have been installed on the walls and floor as required prior to erection of the ladder.
- C. Correct unsatisfactory conditions prior to start of installation.

#### **3.02 INSTALLATION**

- A. Install components in accordance with manufacturer's instructions.
- B. Install to avoid conflict with access door or roof hatch operation.
- C. Fastening to In-Place Construction: Provide anchorage devices and fasteners where metal fabrications are required to be fastened to in-place construction. Provide threaded fasteners for use with concrete and masonry inserts, toggle bolts, through bolts, lag screws, wood screws, and other connectors.
- D. Dissimilar Materials: Separate dissimilar surfaces in contact with, or in close proximity to
  - 1. non-compatible metals, concrete masonry, or plaster with neoprene gaskets or other approved means.

#### **3.03 INTERFACE WITH OTHER WORK**

- A. Locate ladders, access doors, hatches, safety doors and safety posts to avoid conflict with one another and with other construction items.

#### **3.04 ERECTION TOLERANCES**

- A. Maximum Variation From True Position: 1/4 inch.
- B. Maximum Offset From True Alignment: 1/8 inch.

#### **3.05 ADJUSTING, CLEANING AND PROTECTION**

- A. Adjust moving items for smooth operation.
- B. Clean finished work.
- C. Protected completed work from damage until acceptance.

**END OF SECTION**

**SECTION 05 7000**  
**DECORATIVE METAL**

**PART 1 GENERAL**

**1.01 SECTION INCLUDES**

- A. Section includes aluminum plate panels with laser cut patterns for exterior applications.
  - 1. Decorative metal architectural elements.
  - 2. Decorative metal guard railing infill.

**1.02 RELATED REQUIREMENTS**

- A. Pertinent Sections specifying Volatile Organic Compound (VOC) Content Restrictions.
- B. Section 05 5000 - METAL FABRICATIONS: Supports.

**1.03 REFERENCE STANDARDS**

- A. AAMA 2604 - Voluntary Specification, Performance Requirements and Test Procedures for High Performance Organic Coatings on Aluminum Extrusions and Panels; 2013.
- B. ASTM B221 - Standard Specification for Aluminum and Aluminum-Alloy Extruded Bars, Rods, Wire, Profiles, and Tubes; 2014.
- C. ASTM B221M - Standard Specification for Aluminum and Aluminum-Alloy Extruded Bars, Rods, Wire, Profiles, and Tubes [Metric]; 2013.
- D. California Code of Regulations, Title 24, Part 2, California Building Code (CBC), International Building Code.
- E. California Code of Regulations, Title 24, Part 11, California Green Building Standards Code, "CAL-Green".

**1.04 ADMINISTRATIVE REQUIREMENTS**

- A. Pre-Installation Meeting: Schedule and conduct a preinstallation meeting one week before starting work of this section. Attendees shall include, but not be limited to:
  - 1. Contractor.
  - 2. Manufacturer's representative.
  - 3. Architect.
  - 4. Owner's representative.
  - 5. Other subcontractors of adjacent work.

**1.05 SUBMITTALS**

- A. General: Submit in accordance with Section 01 3300.
- B. Product Data: Submit manufacturer's product data including description of materials, components, finishes, fabrication details, glass, anchors, and accessories.
- C. CAL-GREEN Submittals: Product Data - VOC Limits: For adhesives sealants, fillers, primers and coatings, documentation including printed statement of VOC contents, comply with limits specified in related section.
- D. Shop Drawings: Indicate metal screen system elevations and sections, details of profile, pattern, dimensions, sizes, connection attachments, anchorage, size and type of fasteners, and accessories. Indicate anchor and joint locations, brazed connections, transitions, and terminations.
- E. Samples: Submit one (1) of each item below for each type and condition shown.

1. Screen Cladding: 24 inch by 24 inch (\_\_\_\_ mm by \_\_\_\_ mm) sample of each type of screen cladding, illustrating finish and pattern.
- F. Test Reports: Submit test reports from an independent testing agency showing compliance with specified design and performance requirements.
- G. Manufacturer's Installation Instructions.
- H. Maintenance Data: Manufacturer's instructions for care and cleaning.
- I. Warranty: Submit manufacturer warranty and ensure that forms have been completed in Owner's name and registered with manufacturer.

#### **1.06 QUALITY ASSURANCE**

- A. Manufacturer Qualifications:
  1. Engage a single firm with a minimum of 5 years successful experience in the fabrication of panel systems of similar sizes, shapes, designs and finishes as required for this project.
  2. Production facilities are capable of producing and supplying the panels as required for installation per the construction schedule.
- B. Installer Qualifications: Engage a single firm with a minimum of 5 years successful experience in the erection of panel systems of similar sizes, shapes and finishes as required for this project; with adequate manpower, expertise and equipment to layout, and install the complete panel system.
- C. Templates: Supply installation templates, reinforcing and required anchorage devices.

#### **1.07 MOCK-UP**

- A. Provide mock-up of batten assembly, 8 feet (\_\_\_\_ m) long by 10 feet (\_\_\_\_ m) wide, illustrating each type of material, cladding, and finish.
- B. Locate where directed.
- C. Mock-up may remain as part of the Work.

#### **1.08 DELIVERY, STORAGE, AND HANDLING**

- A. Deliver materials in factory provided protective coverings and packaging.
- B. Protect materials against damage during transit, delivery, storage, and installation at site.
- C. Inspect materials upon delivery for damage. Repair damage to be indistinguishable from undamaged areas; if damage cannot be repaired to be indistinguishable from undamaged parts and finishes, replace damaged items.
- D. Prior to installation, store materials and components under cover, in a dry location.
- E. Retain strippable protective covering on metal panels during installation.

#### **1.09 WARRANTY**

- A. Warranty: Manufacturer's standard one year warranty against defects in materials, fabrication, and installation commencing on Date of Substantial Completion.
- B. Special Finish Warranty: Manufacturer's standard fifteen (15) year warranty against defects in finishes, including checking, cracking, chalking, color change, gloss retention, and adhesion of finish, commencing on Date of Substantial Completion.

## **PART 2 PRODUCTS**

### **2.01 PERFORMANCE REQUIREMENTS**

- A. VOC Limits for adhesives, sealants, fillers, primers and coatings . Comply with limits specified in related section.

### **2.02 DECORATIVE METAL PLATE PANELS**

- A. Metal Plate Panels: Aluminum plate panels with laser cut open patterns by fabricator per Architectural Drawings. Pattern A14 and A26, see drawings for location of each type of panel.
  - 1. Provide materials with smooth surfaces, without seam marks, roller marks, rolled trade names, stains, discolorations or blemishes; unless allowed for specific metal types and finishes.
  - 2. Provide factory-formed, metal plate wall panels fabricated from single sheets of metal formed into profile for installation method indicated. Include all accessories required.
- B. Panel Thickness: 1/8 inch (3 mm).
- C. Aluminum Sheet: Tension-leveled, smooth aluminum sheet, ASTM B 209.
- D. Aluminum Extrusions: ASTM B 221, 0.125 inch minimum wall thickness.
- E. Attachment: As detailed on Drawings.
- F. Acceptable Manufacturers:
  - 1. BOK™ Modern, San Francisco, CA; tel: (415)749-6500; web: <http://bokmodern.com> .
  - 2. California Panel Systems (CPS), El Cajon, CA; tel: (619) 562 7010; web: <http://calpanelsystems.com> .
  - 3. Steel Crest Architectural Panels; <https://www.steelcrestonline.com>.
  - 4. Substitutions: Per Division 01.

### **2.03 MATERIALS**

- A. Aluminum Components: ASTM B221 or ASTM B221M.
  - 1. Tubes: Schedule 40 pipe.
  - 2. High Performance Organic Finish: AAMA 2604; multiple coats, thermally cured fluoropolymer system.

### **2.04 ACCESSORIES**

- A. Panel Accessories: Provide components required for a complete panel system including trim, copings, fasciae, mullions, sills, corner units, clips, flashings, sealants, gaskets, fillers, closure strips, and similar items. Match material and finish of metal panels unless otherwise indicated.
- B. Flashing and Trim: Provide flashing and trim formed from same material as metal panels as required to seal against weather and to provide finished appearance. Locations include, but are not limited to, bases, drips, sills, jambs, corners, end walls, framed openings, rakes, fasciae, parapet caps, soffits, reveals, and fillers. Finish flashing and trim with same finish system as adjacent metal panels.
- C. Anchors and Fasteners: Provide anchors and other materials as required to attach to structure, made of same materials as railing components unless otherwise indicated; where exposed fasteners are unavoidable provide flush countersunk fasteners. For attachment of aluminum, provide stainless steel fasteners.
  - 1. For anchorage to concrete, provide inserts to be cast into concrete for bolting anchors.
  - 2. For anchorage to masonry, provide brackets to be embedded in masonry for bolting anchors.

3. For anchorage to stud walls, provide backing plates for bolting anchors.
4. Exposed Fasteners: No exposed bolts or screws.

D. Sealant: Silicone; to match panel color.

## 2.05 FABRICATION

- A. General: Fabricate and finish metal panels and accessories at the factory, by manufacturer's standard procedures and processes, as necessary to fulfill indicated performance and design requirements. Comply with indicated profiles and with dimensional and structural requirements.
  1. Die marks in finished materials are not acceptable.
- B. Fabricate metal panel assemblies to comply with requirements indicated for design, dimensions, member sizes and spacing, details, finish and anchorage, but not less than required to support structural loads.
- C. Fabricate systems in accordance with approved shop drawings and the supplier's instructions. Form work true to line and level with accurate angles and surfaces.
- D. Assemble metal panels in the shop to greatest extent possible to minimize field splicing and assembly.
- E. Cut, drill and laser cut metals cleanly and accurately. Remove burrs and ease edges; unless allowed for specific metal types and finishes. Remove sharp or rough areas on exposed surfaces.
- F. Cut, reinforce, drill and tap as indicated to receive finish hardware, screws and similar items.
- G. Use grommets, bushings and washers or methods as recommended by the supplier for separation of dissimilar metals.
- H. Tolerances:
  1. Panel Bow: Maximum 0.2 percent of width or length, whichever is greater.
  2. Wide or Length Variation:  $\pm 0.064$  inch to 48 inch,  $\pm 0.032$  inch to 144 inch.
  3. Thickness Variation:  $\pm 0.008$  inch.
  4. Squareness Variation: 0.1875 inch difference between diagonals.
  5. Camber Variation: 0.062 inch maximum.

## 2.06 FINISHES

- A. General: Comply with NAAMM's "Metal Finishes Manual for Architectural and Metal Products" for recommendations for applying and designating finishes.
  1. Finish designations prefixed by AA comply with the system established by the Aluminum Association for designating aluminum finishes.
  2. Protect mechanical and painted finishes on exposed surfaces from damage by applying a strippable, temporary protective covering before shipping.
  3. Appearance of Finished Work: Variations in appearance of abutting or adjacent pieces are acceptable if they are within one-half of the range of approved Samples. Noticeable variations in same piece are not acceptable. Variations in appearance of other components are acceptable if they are within the range of approved Samples and are assembled or installed to minimize contrast.
  4. Exposed surfaces shall be free of scratches and other serious blemishes.
- B. Finishes for Aluminum Panels and Accessories:
  1. Three-Coat Fluoropolymer: AAMA 2605. Fluoropolymer finish containing not less than 70 percent PVDF resin by weight in both color coat and clear topcoat. Prepare, pretreat, and apply coating to exposed metal surfaces to comply with coating and resin manufacturers' written instructions.

- a. Color: As shown on finish schedule.

### **PART 3 EXECUTION**

#### **3.01 EXAMINATION**

- A. Verify that substrate and site conditions are acceptable and ready to receive work.
- B. Verify field dimensions of locations and areas to receive work.
- C. Notify Architect immediately of conditions that would prevent satisfactory installation.
- D. Do not proceed with work until detrimental conditions have been corrected.
- E. Furnish components to be installed in other work to installer of that other work, including but not limited to blocking, sleeves, inserts, anchor bolts, embedded plates and supports for attachment of anchors.

#### **3.02 PREPARATION**

- A. Review installation drawings before beginning installation. Coordinate diagrams, templates, instructions and directions for installation of anchorages and fasteners.
- B. Clean surfaces to receive units. Remove materials and substances detrimental to the installation.

#### **3.03 INSTALLATION**

- A. Comply with manufacturer's drawings and written instructions.
- B. General: Install metal panels according to approved shop drawings in orientation, sizes, and locations indicated. Anchor metal panels and other components of the Work securely in place, with provisions for thermal and structural movement.
- C. Flashing and Trim: Comply with performance requirements, manufacturer's written installation instructions, and SMACNA's "Architectural Sheet Metal Manual."
  1. Install exposed flashing and trim that is without buckling and tool marks and that is true to line and levels indicated, with exposed edges folded back to form hems. Install sheet metal flashing and trim to fit substrates and to result in waterproof performance.
  2. Expansion Provisions: Provide for thermal expansion of exposed flashing and trim.
- D. Install components plumb and level, accurately fitted, free from distortion or defects and with tight joints, except where necessary for expansion.
- E. Anchor securely to structure using fasteners of size, type, spacing, and embedment to resist imposed loads.
- F. Conceal anchor bolts and screws whenever possible. Request Architect written permission for exposed fasteners.
- G. Isolate dissimilar materials with bushings, grommets or washers to prevent electrolytic corrosion.

#### **3.04 TOLERANCES**

- A. Maximum Variation From Plumb: 1/4 inch (6 mm) per floor level, non-cumulative.
- B. Maximum Offset From True Alignment: 1/4 inch (6 mm).
- C. Maximum Out-of-Position: 1/4 inch (6 mm).

#### **3.05 CLEANING**

- A. Remove protective film from exposed metal surfaces.

- B. Metal: Clean exposed metal finishes with potable water and mild detergent, in accordance with manufacturer recommendations; do not use abrasive materials or chemicals, detergents or other substances that may damage the material or finish.

**3.06 PROTECTION**

- A. Protect installed components and finishes from damage after installation.
- B. Repair damage to exposed finishes to be indistinguishable from undamaged areas.
  - 1. If damage to finishes and components cannot be repaired to be indistinguishable from undamaged finishes and components, replace damaged items.

**END OF SECTION**

## SECTION 06 1000

### ROUGH CARPENTRY

#### PART 1 GENERAL

##### 1.01 SUMMARY

- A. Section Includes: All labor, materials and equipment and all operations required to complete all rough carpentry and structural framing as indicated on the drawings; to produce shapes and configurations as shown, as required; and as specified herein, including:
1. Structural floor, wall, and roof framing.
  2. Floor, wall, and roof sheathing.
  3. Rough hardware, framing connectors and fasteners.
  4. Treatment of wood.
  5. Concealed wood blocking for support of toilet and bath accessories, wall cabinets, wood trim, and other work requiring supporting blocking.
  6. Miscellaneous wood nailers and furring strips, including roof applications, other wood framing, furring, shims or blocking as required to complete the work.
- B. Related Sections:
1. Pertinent sections of Division 01 specifying Quality Control and Testing Agency services.
  2. Pertinent sections of Division 01 specifying Structural Product Requirements: Structural Product Options, Substitution procedures and limitations, transportation, handling and storage.
  3. Pertinent sections of Division 03 specifying wood formwork construction and/or setting anchors in concrete.
  4. Pertinent section of Division 06 specifying wood construction and materials.
  5. Pertinent sections of other divisions specifying steel or concrete construction.

##### 1.02 REFERENCES

- A. California Code of Regulations, Title 24, latest adopted edition (herein noted as CBC): Chapter 23 Wood.
- B. American National Standards Institute (ANSI) / American Wood Council (AWC) "NDS - National Design Specification for Wood Construction".
- C. National Institute of Standards and Technology (NIST) / Engineered Wood Association (APA) "PS 1 - Voluntary Product Standard for Structural Plywood".
- D. NIST / APA "PS 2 - Performance Standard for Wood-Based Structural-Use Panels".
- E. NIST "PS 20 - American Softwood Lumber Standard".
- F. Redwood Inspection Bureau (RIS) "Standard Specifications for Grades of California Redwood Lumber".
- G. West Coast Lumber Inspection Bureau (WCLIB) "Standard Grading Rules for West Coast Lumber No. 17".



- H. Western Wood Products Association (WWPA) "Western Lumber Grading Rules".
- I. American Wood Preservers Association (AWPA) "Book of Standards".

### 1.03 SUBMITTALS

- A. Submit in accordance with pertinent sections of Division 01 specifying submittal procedures. Submit for review prior to fabrication. Submittals that do not meet these requirements will be returned for correction without review.
  - 1. Substitutions for products specified require conformance to substitution requirements in Division 01.
  - 2. Review of materials and hardware for substitution to products specified is at the additional expense of the Contractor.
- B. Limitation of Review: Structural Engineer's review will be for general conformance with design intent as indicated in the Contract Documents and does not relieve Contractor of full responsibility for conformance with the Contract Documents. The General Contractor shall review and approve shop drawings prior to submittal to the Architect/Engineer.
- C. Product Data:
  - 1. Submit manufacturer's product data, specifications, and installation instructions for & location of framing connectors, wood preservative materials, application instructions, and fasteners. Include complete, accurate equivalence data when submitting alternate products to those specified. Provide samples of these items upon request.
  - 2. Submit product data and current ICC-ES report for machine-driven nails, fasteners, and equipment, including dimensions of all fasteners, including head, shank diameter and length.
  - 3. Submit samples of each and every type and size of proposed machine-driven nails and fasteners.
- D. Shop drawings: For manufactured wood products, submit each building as a complete unit. Do not mix components from multiple buildings or units of work in a submittal. Include all of the following;
  - 1. Indicate profiles, sizes, and spacing locations of structural members.
  - 2. Cross-reference all shop drawing detail references to contract document detail references.
  - 3. Secure all field measurements as necessary to complete this work.
- E. Manufacturer's Certificate: Submit all certifications of physical and chemical properties of materials as specified below in Article titled QUALITY ASSURANCE.
  - 1. Certify that wood products supplied for rough carpentry meet or exceed specified requirements, including specified moisture content.

### 1.04 QUALITY ASSURANCE

- A. Requirements of Regulatory Agencies, refer to pertinent sections of Division 01 and CBC Chapter 17A.

- B. All tests shall be performed by a recognized testing agency as specified in pertinent sections of Division 01.
- C. Inspection of fabricators is required per CBC 1704A.2 unless fabricator is registered and approved by the building official. Wood product quality standards:
  - 1. All wood products to comply with article REFERENCES.
  - 2. Factory-mark each piece of lumber and sheathing with type, grade, mill, and grading agency, except omit marking from surfaces to be exposed with transparent finish or without finish.
  - 3. Sheathing panels to be marked by APA (The Engineered Wood Association).
- D. End-Jointed lumber shall not be used.
- E. Hardware and engineered wood products shall have current ICC ES Evaluation/research reports that are equivalent to products specified.
- F. Employ competent workers experienced in work of the types specified and required.

#### **1.05 MOCK-UP**

- A. Construct mock-ups of machine-driven nailed sheathing panels using submitted products and demonstrating conditions indicated. Locate where directed.
- B. Mock-up shall be accepted and approved by the Inspector of Record (IOR) before commencement of machine-driven nailing activity.
- C. Accepted mock-up shall remain exposed for reference for the duration of machine-driven nailing activity.
- D. Remove all mock-ups at the completion of the work.

#### **1.06 DELIVERY, STORAGE AND HANDLING**

- A. Comply with pertinent requirements of Division 01.
- B. Delivery: Time delivery and installation of carpentry products to avoid delaying other trades whose work is dependent on or affected by this section and to comply with moisture content, protection and storage requirements.
- C. Keep materials dry at all times. Protect against exposure to weather and contact with damp or wet surfaces. Stack lumber and sheathing panels to prevent deformation and provide air circulation within stacks.
  - 1. Store materials for which a maximum moisture content is specified only in areas where relative humidity has been reduced to a level where specified moisture content can be maintained.
  - 2. Handle and store materials above ground to prevent damage, contamination, or accumulation of dirt or foreign materials.

3. Provide special protection for horizontal sheathing panels. Deformation of panels due to moisture is not acceptable.

## 1.07 PROJECT/SITE CONDITIONS

- A. Verify all conditions at project site affecting the work; work to field dimensions as required. Coordinate carpentry installation with size, location, and installation of service utilities.
- B. Sequence rough carpentry installation activities to allow sufficient time for:
  1. Review of all submittals, including machine-driven nail sample submittals.
  2. Fabrication of mock-ups and required durations as specified.
  3. Indicate submittal review, procurement, mock-up, and testing activities in the project schedule prior to the start of installation. Installation durations shall be based on hand-nailed installation methods specified.
  4. Attainment of specified maximum lumber moisture content.

## PART 2 PRODUCTS

### 2.01 DIMENSIONED LUMBER

- A. General
  1. Size per industry standards for nominal sizes shown; S4S (sanded four sides).
  2. Warped/twisted and excessively checked members shall not be used regardless of grade marks.
  3. At the Contractor's option, engineered lumber of equivalent size and material properties may be substituted for solid sawn lumber where material is difficult to source due to length, availability, etc. Submit proposed substitution to Engineer for review prior to purchasing materials.
- B. Moisture content of framing:
  1. All lumber to be maximum 19% at time of fastener installation, except 3x and 4x studs may be 25% at time of sheathing panel nailing. All lumber to be maximum 19% at time of close-in, unless noted otherwise.
  2. The Owner's Testing Laboratory will test for moisture content prior to commencement of close-in.
  3. The Contractor shall recognize that excessive shrinkage of lumber results from excess moisture content at the time of installation. The Contractor will compensate for use of such lumber by waiting for acceptable moisture content before close in and/or by replacing/repairing lumber that has sagged, twisted, or warped prior to close in.
  4. Deviation from this specification would require structural redesign of connections and fasteners.
- C. Sills/ledgers on concrete or masonry: No. 2 pressure treated Douglas Fir and as called for on the drawings.
- D. Interior structural framing shall be Douglas Fir (D.F.) with grades as noted below, unless otherwise specified on the drawings. All grades are per WCLIB standard grading rules.

1. All permanently exposed (interior or protected from weather) framing shall be select structural grade with no box heart.
2. Except per 1 above, unless noted otherwise, minimum grades are:
  - a. Floor/roof joists/rafters (2x) and 2x8 & larger studs & plates: D.F. No. 1
  - b. 2x4 and 2x6 studs and plates: D.F. No. 1
  - c. 4x and larger: D.F. No. 1
  - d. Blocking: D.F. No. 2
  - e. 6x8 and larger posts and beams may be SGL/CGL per below unless noted otherwise on the drawings.
- E. Exterior structural framing (exposed to weather) shall be redwood select structural grade or pressure treated D.F. No. 1, unless noted otherwise.
- F. Structural decking shall be D.F. select decking or White Pine select where not exposed to moisture. Where directly exposed to moisture or high humidity for prolonged periods of time, decking shall be Alaskan Yellow Cedar or Port Orford Cedar. Moisture content at time of installation to be less than 12%.
- G. Framing not otherwise shown or specified: Douglas Fir construction grade per WCLIB paragraphs applicable to uses and sizes required.

## 2.02 MANUFACTURED LUMBER

- A. Structural (Certified) Glued Lumber (SGL): SGL shall be manufactured following the American Lumber Standards Committee (ALSC) "Glued Lumber Policy" and meet the requirements of Voluntary Product Standard PS 20 "American Softwood Lumber Standard". Grading shall be per the West Coast Lumber Inspection Bureau (WCLIB) or Western Wood Products Association (WWPA). SGL shall be manufactured with waterproof adhesive. "Stud use only" SGL is not permitted.
  1. Acceptable products:
    - a. "RMT" by Rosboro.
    - b. Approved equal.
  2. Where specified for use on plan, SGL shall be entirely Douglas Fir lumber. SGL shall be grademarked to match the grade as would be specified for solid sawn lumber in the same location/use.
  3. At the contractor's option, SGL may be substituted for solid sawn lumber. SGL species and grade shall match that for the solid sawn member. SGL shall not be substituted for glued-laminated (glulam) members.
- B. Laminated Veneer Lumber (LVL): for use as joists, beams, blocking, or studs when so noted on the drawings. Conform to ICC AC 47. Minimum  $F_b = 2,900$  PSI. Minimum  $E = 2,000,000$  PSI.  
Acceptable products:
  1. "Microllam LVL" by Trus Joist, ICC ESR-1387
  2. "Redlam LVL" by RedBuilt, ICC ESR-2993
  3. Approved equal
- C. Laminated Strand Lumber (LSL): for use as blocking (flat or vertical) or rim joist when used with I-joist or LVL, when so noted on the drawings. Conform to ICC AC 124. Minimum  $F_b =$

1,700 PSI. Minimum E=1,300,000 PSI. Acceptable products:

1. "Timberstrand LSL" by Trus Joist, ICC ESR-1387
2. "Redlam LSL" by Redbuilt, ICC ESR-1387
3. Approved equal

D. Parallel Strand Lumber (PSL): for use as beams and posts when so noted on the drawings. Conform to ICC AC 47. Minimum material properties for beams: E = 2,000,000 psi;  $F_b = 2,900$  psi;  $F_c = 2,900$  psi (parallel);  $F_v = 290$  psi. Minimum material properties for posts: E = 1,800,000 psi;  $F_b = 2,400$  psi;  $F_c = 2,500$  psi (parallel);  $F_v = 190$  psi. Acceptable products:

1. "Parallam PSL" by Trus Joist, ICC ESR-1387
2. Approved equal

### 2.03 MANUFACTURED STRUCTURAL PANELS

- A. Plywood: Structural sheathing shall conform to product standard PS-1 or PS-2. All panels shall have an exterior exposure rating and bear the trademark of the Engineering Wood Association (APA) or other qualified agency. Grades shall be as required on the drawings.
- B. Oriented Strand Board (OSB): All structural OSB shall be grade marked by a qualified agency for conformance with Product Standard PS-2 and shall be fabricated with exterior glue. Grades shall be as required on the drawings.

### 2.04 TREATED WOOD:

- A. Treated Lumber and Plywood: Comply with requirements of AWWA Standard U1. See Standard U1 for "Use Category" designations. Do not provide higher Use Category lumber than that specified. Maximum moisture content shall be the same as required for "dimensioned lumber" as specified above.
- B. Preservative Treated Lumber
  1. General
    - a. Preservatives shall be waterborne. Preservative retention rate shall be as required per AWWA Standards U1 & T1. Lumber shall be Douglas Fir No. 2 (or better). Cut faces of treated wood shall be brush treated (two complete applications) prior to installation.
    - b. Lumber less than 8 inches above grade and lumber less than 6 inches above exterior hard-surface flatwork shall be treated.
    - c. Each piece of wood shall be stamped by the wood preservative applicator to identify its treatment and preservative retention.
  2. Lumber at interior, non-weather exposed locations installed adjacent to concrete or masonry shall be Use Category UC2. Examples include sill plates & ledgers and lumber in contact with roofing, flashing, or water proofing.
  3. Lumber at exterior locations, not in contact with soil/ground, shall be Use Category UC3B. Examples include Douglas Fir decking and deck framing.
  4. Lumber in contact with soil/ground shall be Use Category UC4A. Examples include timber retaining walls.
  5. Poles, posts, and sheathing panels shall be treated as recommended by AWWA Standard U1 per use and exposure.

6. Maximum Volatile Organic Compound (VOC) content of field-applied preservative shall meet local air quality standards and the California Green Building Code. Provide either of the following:
  - a. Copper Azole (CA-B) per ICC-ES AC326.
  - b. Alkaline/Copper/Quaternary (ACQ).
- C. Fire Retardant Treatment: Product and application process must be recommended by manufacturer of treatment as being suitable for painting. Application shall be by a California State Fire Marshal approved licensed contractor.
  1. Exterior Type: Use Category UCFB, chemically treated, and pressure impregnated; capable of providing a maximum flame spread rating of 25 when tested in accordance with ASTM E84, with no evidence of significant combustion when test is extended for an additional 20 minutes both before and after accelerated weathering test performed in accordance with ASTM D2898.
    - a. Treat exposed exterior rough carpentry items, including stairways, balconies, and covered walkways.
    - b. Do not use treated wood in direct contact with the ground.
  2. Interior Type: Use Category UCFA, low temperature (low hygroscopic) type, chemically treated, and pressure impregnated; capable of providing a maximum flame spread rating of 25 when tested in accordance with ASTM E84, with no evidence of significant combustion when test is extended for an additional 20 minutes.
    - a. Treat rough carpentry items as indicated.
    - b. Do not use treated wood in applications exposed to weather or where the wood may become wet.

## 2.05 FASTENERS AND ACCESSORIES

- A. General requirements for fasteners:
  1. Fasteners shall be of adequate size, spacing, and number to resist design loads under intended use, and types shall be appropriate for the materials or conditions for which used.
  2. Provide washers, pre-drilling, etc. as required for proper installation and to prevent damage to framing.
  3. Fasteners shall be hot-dip galvanized (ASTM A153), mechanically galvanized (ASTM B695 class 55 minimum), stainless steel (type 303, 304, 305, or 316), silicon bronze, or copper by approved methods for the following applications:
    - a. Exterior, exposed use.
    - b. In contact with preservative or fire-retardant treated wood.
  4. Fasteners in moist corrosive atmosphere to be of stainless steel (type 303, 304, 305, or 316).
  5. Where the retention level of ACQ or MCQ preservative is greater than 0.40 pcf, CBA-A preservative is greater than 0.41 pcf, or CA-B preservative is greater than 0.21 pcf, provide stainless steel fasteners (type 303, 304, 305, or 316).
  6. All fasteners specified by manufacturer shall be installed in framing hardware, unless noted otherwise.
- B. Nails and nailing not otherwise shown or specified:
  1. Comply with requirements of governing building code.

2. For securing materials to hardened concrete or masonry provide hardened steel masonry nails or Simpson Strong-Tie "Titen" screws.
  3. For framing and general woodwork: Common bright wire nails (not box nails) with centered full-round heads per ASTM F1667 including Supplement S1. 16d cement coated sinker nails may be used in lieu of common nails for framing, where noted on the drawings. Unless otherwise noted on drawings, nail sizes shall be as follows:
    - a. 8d Common: 0.131"  $\varnothing$  x 2-1/2" long with 0.281"  $\varnothing$  head.
    - b. 10d Common: 0.148"  $\varnothing$  x 3" long with 0.312"  $\varnothing$  head.
    - c. 16d Common: 0.162"  $\varnothing$  x 3-1/2" long with 0.344"  $\varnothing$  head.
  4. Nails for sheathing panels shall be of common wire with full round heads and shall be of sufficient length to fully develop the nails.
  5. Machine-driven nails of all types must comply with the requirements of this section. All proposed nails shall match diameter and penetration of specified nails.
  6. Staples shall conform to length and gauges specified and shall be installed to match specified patterns and spacing.
  7. Powder-Driven Pins (PDP): Use only as approved by the Architect/Engineer; operators shall be qualified.
- C. Bolts: Malleable iron washers or steel plate washers, unless otherwise shown, shall be provided under all bolt heads and nuts.
1. Machine Bolts: ASTM A307 and ANSI/ASME B18.2.1, standard semi-finished machine bolts as shown or required. Nuts shall be standard size unless noted otherwise and shall be per ASTM A563.
  2. Anchor bolts or threaded rod anchors shall conform to ASTM F1554, ASTM A307, or ASTM A36. Anchor bolts shall be headed or end in two nuts tightened against one another, unless noted otherwise. Provide embedded plate washer as indicated on drawings. No upset threads allowed. No L or J bolts allowed.
- D. Lag screws: Standard hex lag screws per ANSI/ASME B18.2.1.
- E. Wood screws: Standard wood screws per ANSI/ASME B18.6.1.
- F. Powder-Driven Pins (PDP): Hilti X-CP72, ICC ESR-2379; Simpson PDPWL-300 MG, ICC ESR-2138.
- G. Framing hardware: Fabricated sheet metal timber framing connectors shall be manufactured from painted or galvanized G90 steel by Simpson Strong-Tie (connectors specified on drawings are per Simpson Strong Tie, USP Lumber Connectors, or approved equivalent. Connectors shall be at least 16 gauge material, (1/8 inch plate materials where welded), unless otherwise noted, punched for nailing. All heavy hardware to be fabricated from A36 steel per Division 05, Metals. All hardware intended for exterior exposed use shall be galvanized per G185 ASTM A653 or stainless steel.
1. For contact with preservative or fire-retardant treated wood, provide minimum G185 galvanizing per ASTM A653.
  2. Nails and nailing shall conform to the manufacturer's instructions with a nail provided for each punched hole. Nails to be used with framing accessories are subject to the requirements specified in this Section for fasteners and anchors.

- H. Subfloor Glue: Water proof, water base, air cure type, cartridge dispensed conforming to APA Standard AFG-01 or ASTM D3498. Maximum Volatile Organic Compound (VOC) shall meet local air quality standards and the California Green Building Code.

## 2.06 SOURCE QUALITY CONTROL

- A. The Testing Agency, as specified in the Article QUALITY ASSURANCE, will perform testing for moisture content of all lumber at time of fastener installation.
- B. The Testing Agency will submit reports as specified in Division 01.

## PART 3 EXECUTION

### 3.01 REQUIREMENTS FOR STRUCTURAL FRAMING

- A. General
  - 1. Refer to drawings for layouts, notes and details, provide framing as required; comply with governing building code requirements.
  - 2. Provide framing to achieve true alignments as surfaces receiving finish materials.
  - 3. It shall be the responsibility of the Contractor to provide and install all wood blocking, furring strips, or grounds detailed or required to provide anchorage for all finishes, accessories, fixtures, etc. as required to complete all work. All blocking and/or backing shall be securely bolted or otherwise anchored in place.
  - 4. Contractor shall be responsible for layout of anchor bolts, and other hardware embedded in concrete when placed by other trades.
  - 5. Provide and install all structural framing, blocking, fasteners, brackets, clips, etc. as required to complete work specified in the Construction Documents.
- B. Framing
  - 1. Sill Plates and Ledgers:
    - a. Sill plates and ledgers on concrete shall be anchored with bolts, unless noted otherwise, shall have full bearing on concrete, and shall be placed for sheathing panel nailing as indicated. All bolt nuts shall be provided with a cut plate steel washer for bearing on wood.
    - b. Provide a minimum of two sill anchor bolts per sill piece with a bolt no less than 4 1/2" and no more than 12" from the end of the sill. Bolts to be 5/8" diameter x 12" (18" at curb) long at 48" on centers, unless otherwise shown or noted. Provide additional anchor bolts each side of a notch or hole, as per a typical plate splice, where notch or hole is in excess of 1/3 the plate width. At shear walls, provide a plate washer 3" x 3" x 0.229" minimum between the sill and nut at anchor bolts. Plate washer to extend within 1/2 inch of the structural wall sheathing. Offset and/or stagger anchor bolts, or provide larger plate washer as required.
    - c. Anchor bolt holes in sill plates or ledgers shall be 1/16" maximum larger than anchor bolt.
  - 2. Stud Walls and Framing:
    - a. Cut studs and posts with square ends, unless otherwise shown or noted. All posts and beams shall be "cut to bear" unless otherwise detailed.



- b. All studs in walls shall be placed with the shortest dimension parallel to the run of the wall. Bearing studs shall extend full height to be the supporting framing as shown; non-bearing studs shall extend to the supporting framing.
  - c. Provide double studs on each side of all openings, unless shown or noted otherwise.
  - d. All openings in stud walls and partitions shall be framed with headers across the top, as shown, with a minimum size (6" nominal depth x stud width) resting on short cripple studs, and as shown on the drawings.
  - e. All stud partitions and walls shall have horizontal solid blocking not less than 2x and of the same width as the stud, fitted and nailed into the studs at mid-height of stud, for studs over 8 feet in height, except as otherwise shown or specified. This blocking shall be so spaced that there shall be no concealed air spaces greater than eight feet in any dimension.
  - f. Stud partitions containing plumbing, heating or other pipes shall be so framed as to give proper clearance for piping. Plumbing, heating and vent pipes exceeding 1-1/2" in inside diameter shall not be placed in partitions used as bearing or shear walls unless completely furred clear of the wall. No notching shall be allowed. Pipes shall be placed in the center of the plate using a neat bored hole and the plates shall be strapped on each side with 3" x 36" x 14 gauge steel punched for 10d nails 3" on center, staggered, or as shown on the drawings.
3. Top Plates
    - a. Top plates shall be double, set single. Corners where stud wall or partitions meet shall be framed with studs on all surfaces and blocking to form a "rigid" corner with nailing for all corners. Double top plates shall be lapped at corners. Lap splices and nailing per the drawings.
  4. Floor, Roof and Ceiling Framing
    - a. Joists and beams shall be accurately aligned and the position and spacing of all joists and beams shall be as shown and be coordinated with other framing and to other trades prior to actual construction.
    - b. Place all joists and beams with crown up. Cantilevered joists and beams shall be placed with the crown down.
    - c. Cutting of wood girders, beams or joists for electrical and mechanical lines shall be limited to cuts and bored holes not deeper than 1/5 of the beam depth from the top and located not farther from the support than three times the beam depth and not less than the beam depth. Cuts in excess of this, or single bored holes with a diameter of more than 1" are not permitted without special provisions for framing the beams. Location of all cuts in framing shall receive the prior review of the Architect/Engineer.
    - d. Provide vent holes in rafters and/or blocking as shown and/or directed by the Architect.

### 3.02 STRUCTURAL SHEATHING

#### A. General

1. Sheathing nailing shall be as required on the drawings. Do not overdrive (Do not break skin of sheathing face sheet). Over driving will be cause for rejection.
2. Form sheathing may be re-used for concealed sheathing provided the lumber at the time of re-use is approved by the Architect, meets with the framing grade requirements specified herein, is in good condition, and is thoroughly cleaned with all nails removed.

3. Pneumatic nailing devices shall be adjustable so that nail heads do not penetrate skin of sheathing. Contractor shall submit equipment and nails for review prior to use. Refer to PART 2 for other nailing requirements.
- B. Roof Sheathing: Lay with face grain perpendicular to roof rafters. Stagger sheets. Block all unsupported sheet edges with 2x material unless noted otherwise.
- C. Wall Sheathing: Lay with face grain either parallel or perpendicular to studs. Exposed bottom edges shall be sealed as recommended by manufacturer. Block all unsupported sheet edges with 2x materials unless noted otherwise.

### 3.03 ROUGH HARDWARE

- A. General: Nails, spikes, screws, fabricated sheet metal anchors, ties, hangers and any other materials shown or required for the attachment of wood to concrete and wood to steel and wood to wood shall be furnished and installed as part of this work.
- B. Framing Nailing: All framing nailing shall conform to minimum requirements of the Building Code, and with details shown on the drawing.
- C. Bolts, Lag Screws and Washers:
  1. Bolts in wood shall be machine bolts unless otherwise noted and shall be of such length that the bearing length of the treads does not exceed  $\frac{1}{4}$  of the full bearing length in the member holding the treads. Bolt holes in wood shall be  $\frac{1}{32}$ " oversized. Bolt holes for sill plates may be  $\frac{1}{16}$ " maximum oversize. Holes in steel shall be  $\frac{1}{16}$ " oversize. See Section 3.1 for anchor bolts at sill plates and ledgers.
  2. Provide square plate or malleable iron washer and nut at head where bearing is against wood; cut washer under nut where it is against steel. Washer will not be required under head of carriage bolts. Provide malleable iron washers where exposed.
  3. All nuts shall be tightened when placed and retightened at completion of the job or immediately before closing with final construction.
  4. Lag screws shall be screwed (not driven) into place. Drill pilot hole to 70% of shank diameter. Drill clearance hole to full shank diameter and depth of unthreaded screw length.
- D. Wood Screws: Minimum penetration is 10 diameters unless noted otherwise. Where fastening hardwood timber species or where wood tends to split, provide pilot hole 70% of screw shank diameter.

### 3.04 INSTALLATION OF ACCESSORIES AND MISCELLANEOUS WOOD

- A. Coordinate installation of wood decking, metal-web wood joists, glued-laminated wood construction, shop-fabricated wood trusses, and wood I-joists.
- B. Curb roof openings except where prefabricated curbs are provided. Form corners by alternating lapping side members. Fasten curbs corner-to-corner and to rafters with framing connectors configured for this application.
- C. Blocking:

1. Provide fire blocking at locations and spacing's as required by CBC Chapter 7. Locate other blocking, supplementary framing, backing plates and bracing to facilitate installation of finish materials, fixtures, equipment, services, accessories, and trim requiring attachment and support.
  2. Solid block joists and rafters over all supports with blocking of the same size and material as the joist or rafter.
- D. Furring:
1. Nominal 1 inch x 3 inch minimum, continuous and spaced at 16 inches on center, maximum.
  2. Install plumb, rigid, and level. Shim where necessary to provide a true, even plane suitable to receive the finish required.
  3. Attach to concrete and masonry as shown in the contract drawings.
- E. Bridging: Use 2 inch solid cross bridging. Nail bottom ends of bridging only after sheathing has been nailed.
- F. Stair Framing: Provide with 3 stair stringers for each set of stairs, unless otherwise shown. Cut notches to receive exact size of treads and risers (if any) shown, with no change in dimensions between landings. Provide stringers of size shown, or if not shown, of a size to allow not less than 3-1/2 inch of effective depth, measured perpendicular to the rake of the stringer, after notching.
- G. Install miscellaneous metal angles, bolts, and other items; secure into formwork where embedded in concrete.
- H. Install accessory items not otherwise set under other sections; after completion of painting and other finishing work; in locations shown or directed by the Architect. Set items plumb, level, and secure using appropriate fastening as applicable.

### **3.05 FIELD APPLIED WOOD TREATMENT**

- A. Field treat all end cuts and holes in preservative treated materials per PART 2.
- B. Apply two brush coats; or full-immersion dip not less than 15 minutes; or as required to thoroughly saturate all surfaces after cutting.
- C. Air dry 2-hours minimum before installation.

### **3.06 TOLERANCES**

- A. Framing Members: 1/4 inch from true position, maximum.
- B. Surface Flatness of Floor: 1/8 inch in 10 feet maximum, and 1/4 inch in 30 feet maximum.
- C. Variation from Plane (Other than Floors): 1/8 inch in 10 feet maximum, and 1/4 inch in 30 feet maximum. Provide framed substrates meeting requirements for application of finishes specified in other sections.

- D. Exposed surfaces shall be free from dents and tool marks, unsanded rough or torn faces and corners, and other defects.

### **3.07 FIELD QUALITY CONTROL**

- A. The Testing Agency, as specified in the Article QUALITY ASSURANCE, will perform the following tests and submit reports as specified in Division 01:
  - 1. Moisture content of all lumber at time of close-in.
  - 2. Periodic special inspection of nailing, bolting, and other fastening within the seismic-force-resisting system including shear walls, wood diaphragms, etc. per CBC Section 1705A.12.2.
  - 3. Special inspection of high load diaphragms per CBC Section 1705A.5.1 where designated on documents.

### **3.08 ADJUSTING**

- A. Replace all defective work at Contractor's expense.
- B. Replace defective or damaged work with conforming work.
- C. Correct defects using means that will not injure the materials.
- D. Replace defective or damaged work which cannot be corrected in the field with new work, or return defective items to the shop for repair.
- E. Repair or replace framing lumber sagged, twisted or warped due to shrinkage from excessive moisture content at time of installation, or from other causes.
- F. Adjust to meet specified tolerances.
- G. Architect/Engineer shall review all proposals for the repair or replacement of damaged, defective, or missing work.
- H. Pay expenses incurred by Owner for Architect/Engineer's costs for (re-)design and obtaining approvals of Authorities Having Jurisdiction (AHJ) necessitated by incomplete, inefficiently scheduled, improperly performed, defective or nonconforming work.
- I. Pay expenses due to re-testing and re-inspection necessitated by incomplete, inefficiently scheduled, improperly performed, defective or nonconforming work.

### **3.09 CLEANING AND PROTECTION**

- A. Clean all surfaces upon completion of erection, leave free of grime and dirt. Remove unused materials, tools, equipment, and debris from the premises and leave surfaces broomed clean.
- B. Waste Disposal: Comply with the requirements of pertinent sections of Division 01 specifying cleaning and disposal.
  - 1. Comply with applicable regulations.
  - 2. Do not burn scrap on project site.
  - 3. Do not burn scraps that have been pressure treated.

4. Do not send materials treated with pentachlorophenol, CCA, or ACA to co-generation facilities or “waste-to-energy” facilities.
- C. Do not leave any wood, shavings, sawdust, etc. on the ground or buried in fill.
- D. Prevent sawdust and wood shavings from entering the storm drainage system.
- E. Protect work from damage by subsequent operations.

**END OF SECTION**

## SECTION 06 1733

### WOOD I-JOISTS

#### PART 1 GENERAL

##### 1.01 SUMMARY

- A. Section Include: The furnishing and installation of all wood I-joists as shown on the drawings, herein specified and necessary to complete the work.
- B. Related Sections
  - 1. Pertinent sections of Division 01 specifying Quality Control and Testing Agency Services.
  - 2. Pertinent sections of Division 06 specifying Rough Carpentry.

##### 1.02 REFERENCES

- A. California Code of Regulations, Title 24, latest adopted edition (herein noted as CBC) Chapter 23 Wood.
- B. American National Standards Institute (ANSI) / American Wood Council (AWC) "National Design Standard (NDS) for Wood Construction".
- C. International Code Council Evaluation Service (ICC-ES) "Acceptance Criteria (AC) 14 Prefabricated Wood I-Joists".
- D. American Society for Testing and Materials (ASTM) D5055 "Standard Specification for Establishing and Monitoring Structural Capacities of Prefabricated Wood I-Joists".

##### 1.03 SUBMITTALS

- A. Submit shop drawings, furnished by the Manufacturer, showing all critical dimensions for determining fit and placement in the building and erection instructions.

##### 1.04 QUALITY ASSURANCE

- A. All wood I joists shall be manufactured in a shop approved for fabrication by the Authority Having Jurisdiction (AHJ).
- B. Wood I-joists are not required to be continuously inspected during fabrication, but must carry a stamp indicating the plant of manufacture, date of manufacture, and logo of the third party independent inspection agency, conforming to AC14, and ASTM D5055.
- C. Fabricators must have a minimum of three years experience in manufacturing comparable systems and shall have a valid evaluation report issued by a qualified evaluation agency prescribed in DSA IR A-5.
- D. Wood I-joists delivered shall be free from any defects in materials, and the members shall be adequate to carry the design loads for the life of the building.

#### PART 2 PRODUCTS

## 2.01 MATERIALS

- A. Joists shall be manufactured from materials in the evaluation report and shall be of sizes and shapes shown on the contract documents.
- B. Blocking construction shall be the same as I-joists, unless noted otherwise.

## 2.02 FABRICATION

- A. Camber - None, unless noted otherwise.
- B. Tolerances:
  - 1. Length (between outside bearing edges): +/- 1/2 inch
  - 2. Depth: +/- 3/8 inch
  - 3. Camber: +/- 1/4 inch

## PART 3 EXECUTION

### 3.01 PRODUCT DELIVERY, STORAGE AND HANDLING

- A. Wood I-joists shall be stored in a vertical position and protected from the weather. They shall be handled with care so they are not damaged. Provide bearing supports and bracings to avoid bending or overturning of I-joists, and protect I-joists from construction operations.

### 3.02 ERECTION AND INSTALLATION

- A. Use all means necessary to coordinate the work of this section with the work of other sections to ensure proper and adequate erection of the work of this section.
- B. Wood I-joists shall be installed in accordance with the approved shop drawings and installation instructions therein.
- C. Temporary construction loads, which will cause member stresses beyond design limits, are not permitted.
- D. Erection bracing in addition to specified bridging is to be provided to keep the I-joists straight and plumb as required to assure adequate lateral support for the individual I-joist and entire system until the sheathing material has been applied. Bridging as shown on the drawings and per Manufacturer's recommendations shall be installed as erection of I-joists progresses and before any construction loads are placed on the I-joists.
- E. Round holes may be cut in the I-joist web as indicated on the drawings. Square or rectangular holes may be cut when the diagonal dimension of the square or rectangular hole does not exceed the diameter of the maximum allowable round holes shown on the drawing. Overcut square or rectangular holes shall be treated as a hole matching the overcut. Holes exceeding maximum holes shown on the drawings are cause for rejection of the I-joist.
- F. The Contractor shall give notification prior to enclosing the I-joists to provide opportunity for inspection of the installation.

**END OF SECTION**



**SECTION 06 2000**  
**FINISH CARPENTRY**

**PART 1 GENERAL**

**1.01 SECTION INCLUDES**

- A. Finish carpentry items.
- B. Interior and exterior wood trim;
- C. Crash Rail at exterior trash enclosure.
- D. Exterior wood soffits.
- E. Wood casings and moldings.
- F. Hardware and attachment accessories.

**1.02 RELATED SECTIONS**

- A. Section 01 6116 - Volatile Organic Compound (VOC) Content Restrictions.
- B. Section 01 8113 - Sustainable Design Requirements.
- C. Section 06 1000 - Rough Carpentry: Support framing, grounds, and concealed blocking.
- D. Section 06 4100 - Architectural Wood Casework: Shop fabricated custom cabinet work.
- E. Section 08 1416 - Flush Wood Doors.
- F. Section 09 9123 - Interior Painting: Painting and finishing of finish carpentry items. Backpriming of finish carpentry.
- G. Division 32 - Pertinent Sections specifying wood landscape headers and stakes, fences, gates, benches.

**1.03 REFERENCE STANDARDS**

- A. ASTM Standards: A153, A165, D 226
- B. ASTM E84 - Standard Test Method for Surface Burning Characteristics of Building Materials; 2015a.
- C. AWI/AWMAC/WI (AWS) - Architectural Woodwork Standards; 2014.
- D. AWMAC/WI (NAAWS) - North American Architectural Woodwork Standards, U.S. Version 3.0; 2016.
- E. AWPA C2 - Lumber, Timber, Bridge Ties and Mine Ties -- Preservative Treatment by Pressure Processes; American Wood-Preservers' Association; 2003.
- F. BHMA A156.9 - American National Standard for Cabinet Hardware; 2010.
- G. California Code of Regulations, Title 24, Part 2, California Building Code (CBC), International Building Code.
- H. California Code of Regulations, Title 24, Part 11 California Green Building Standards Code, "CAL-Green".
- I. PS 1 - Structural Plywood; 2009.
- J. PS 20 - American Softwood Lumber Standard; 2010.
- K. PS-51 for decorative plywood.

- L. Redwood Inspection Service (RIS): "Standard Specifications for Grades of California Redwood Lumber" 2000 ed, www.calredwood.org.
- M. West Coast Lumber Inspection Bureau (WCLIB): "Standard Grading and Dressing Rules No. 16".

#### 1.04 SUBMITTALS

- A. See Section 01 3300 - Submittals for submittal procedures.
- B. Product Data:
  - 1. Manufacturer's storage, handling and installation instructions
  - 2. Provide instructions for attachment hardware and finish hardware.
- C. CAL-GREEN Submittals:
  - 1. Product Data – VOC Limits: For adhesives, sealants, fillers, primers and coatings, documentation including printed statement of VOC contents, comply with limits specified in related section.
  - 2. Composite Wood Formaldehyde Limits: Provide certification that all products meet current CARB Airborne Toxic Control Measure (ATCM) for Composite Wood Formaldehyde Limits by Mandatory Compliance Dates as specified in related section.
- D. Shop Drawings: Indicate materials, component profiles, fastening methods, jointing details, and accessories.
  - 1. Scale of Drawings: 1-1/2 inch to 1 foot (125 mm to 1 m), minimum.
  - 2. Provide the information required by AWI/AWMAC/WI (AWS) or AWMAC/WI (NAAWS).
- E. Mill grade certificate, if material cannot be marked on a concealed surface.
- F. Shop Drawings: Indicate materials, component profiles, fastening methods, jointing details, accessories, and details of anchorage, to a minimum scale of 1-1/2 inch to 1 ft (1:8).
- G. Samples of materials for making stain and transparent finish samples.
  - 1. Following review, provide samples to other Sections for application of finishes.
- H. Samples: Submit two samples of finish plywood, 12 by 12 inch (\_\_\_\_ by \_\_\_\_ mm) in size illustrating wood grain and specified finish.
- I. Samples: Submit two samples of each wood trim profile, 12 inch (\_\_\_\_ mm) long.

#### 1.05 QUALITY ASSURANCE

- A. Perform work in accordance with Woodwork Institute Manual of Millwork, Custom grade.
- B. Factory-mark each piece of lumber and plywood with type, grade, mill and grading agency identification; except omit marking from surfaces to receive transparent finish.
- C. Fabricator Qualifications: Company specializing in fabricating the products specified in this section with minimum five years of documented experience.

#### 1.06 DELIVERY, STORAGE, AND HANDLING

- A. Wood: Store indoors, in well ventilated area at maximum relative humidity of 60 percent and in accordance with WIC technical bulletin 419-R.
- B. Protect from moisture damage.

## 1.07 PROJECT CONDITIONS

- A. Sequence installation to ensure utility connections are achieved in an orderly and expeditious manner.
- B. Coordinate the work with plumbing rough-in, electrical rough-in, installation of associated and adjacent components, and interior finishes.

## PART 2 PRODUCTS

### 2.01 PERFORMANCE REQUIREMENTS

- A. VOC Limits for adhesives, sealants, fillers, primers and coatings . Comply with limits specified in related section.
- B. Composite Wood products must meet current CARB Airborne Toxic Control Measure (ATCM) for Composite Wood Formaldehyde Limits by Mandatory Compliance Dates as specified in Section 01 6116.

### 2.02 FINISH CARPENTRY ITEMS

- A. Quality Standard: Custom Grade, in accordance with AWI/AWMAC/WI (AWS) or AWMAC/WI (NAAWS), unless noted otherwise.

### 2.03 LUMBER MATERIALS

- A. Exterior wood: Dry; with moisture content up to 15 percent, unless otherwise indicated.
  - 1. Exterior Trim and Fascias, opaque finish: Redwood Inspection Service Paragraph 107 - "Grade B". RIS Paragraph 109 "Select" for material thinner than 2 inch, and Paragraph 117 "Select" for 2 inch and thicker; S4S; smooth surfaced.
- B. Interior wood: Dry; with moisture content between 6 and 12 percent, unless otherwise indicated. Finger joints not permitted. WI manual, Section 3 and Section 4; "Custom Grade"
  - 1. Softwoods:
    - a. Opaque Finish: Clear; western softwood.
    - 2. Hardwoods: Transparent finish, plain sawn "Select White" maple.
- C. Crash Rail at Trash Enclosure: Construction Heart Redwood.

### 2.04 FASTENINGS

- A. Adhesive for Purposes Other Than Laminate Installation: Suitable for the purpose; not containing formaldehyde or other volatile organic compounds.
- B. Rough Hardware and fasteners: Provide nails, screws, anchor bolts, machine bolts, expansion sleeves, lag screws, powder driven fasteners, joist hangers, straps, and other framing anchors of the size and type required to securely attach finish carpentry to substrates.
  - 1. Nails:
    - a. Exterior Trim Exposed: Nichols-Homeshield, Independent Nail and Packing,
  - 2. Other Exterior Work: Hot-dip galvanized steel.
  - 3. Interior Work: Steel, typical unless otherwise indicated.
  - 4. Screws, Bolts, Washers:
    - a. Exterior Work: Hot-dip galvanized steel, ASTM A153.
    - b. Interior Work: Cadmium plated steel, ASTM A165.
  - 5. Framing Devices:
    - a. Exterior Work: Hot-dip galvanized steel, ASTM A153.
    - b. Interior Work: Plated, ASTM A165; or painted steel.
- C. Concealed Joint Fasteners: Threaded steel.

## **2.05 ACCESSORIES**

- A. Adhesive and Tape
  - 1. 1. Wood Adhesive: Essex Chemical "Webtex 588", Inmont "Presstite 220", 3M "Scotch-Grip 4314" or equal.
- B. Building Paper: #15 imperforate asphalt saturated organic felt, ASTM D226, Type I.
- C. Lumber for Shimming and Blocking: Softwood lumber of Douglas Fir species.
- D. Aluminum Edge Trim: Extruded flat shape; smooth surface finish; self locking serrated tongue; of width to match component thickness; Selected finish. Sizes and profiles as indicated and as recommended by manufacturer to suit application. Fry Products or equal.
- E. Safety Glass: ASTM C1048, fully tempered; clear; 1/8 inch (3 mm) thick, minimum.
- F. Primer: as specified in pertinent sections of Division 09 for finish type indicated.
- G. Wood Filler: Solvent base, VOC Compliant, tinted to match surface finish color. Duratite "Wood Dough", Boyle-Midway "Plastic Wood" or equal.

## **2.06 FABRICATION**

- A. Shop assemble work for delivery to site, permitting passage through building openings.
- B. Mill and fabricate units and pieces as long as practical.
- C. Finish and assemble at shop to greatest extent possible.
- D. Finish to specified standards of Architectural Woodwork Standards (AWS) Manual.
  - 1. Opaque finish, unless otherwise indicated.
- E. When necessary to cut and fit on site, provide materials with ample allowance for cutting. Provide trim for scribing and site cutting.

## **PART 3 EXECUTION**

### **3.01 EXAMINATION**

- A. Verify location of blocking, adequacy of backing and support framing.
- B. Verify mechanical, electrical, and building items affecting work of this section are placed and ready to receive this work.

### **3.02 PREPARATION**

- A. Separate units and condition wood materials for a minimum of 72 hours. Allow wood to achieve prevailing humidity conditions in installation areas prior to installing.
- B. Backprime lumber, including side and ends, before installation for:
  - 1. Exposed exterior surfaces;
  - 2. Where surface is exposed to interior moisture and high relative humidities.

### **3.03 INSTALLATION**

- A. Install custom fabrications in accordance with AWI/AWMAC/WI (AWS) or AWMAC/WI (NAAWS) requirements for grade indicated.
- B. Trim and bases: Install with minimum number of joints possible. Use full-length pieces from maximum lengths of lumber available.
  - 1. Stagger joints in adjacent and related members.
  - 2. Cope at returns and miter at corners. Produce tight fitting joints with full surface contact throughout length of joint.

3. Joints: End-to-end
  - a. Wood: Scarf.
4. Locate wood bases above subfloor by the thickness of finish flooring.
- C. Set and secure materials and components in place, plumb and level.
- D. Carefully scribe work abutting other components, with maximum gaps of 1/32 inch (0.79 mm). Do not use additional overlay trim to conceal larger gaps.
- E. Building paper: Install under exterior wood; without holes or tears.
- F. Lap flashings to weather to the exterior.
  1. Lap horizontal edges 3-inches minimum and vertical edges 6-inches minimum
  2. Lap sheet metal flashings; double layer at corners by extending 6-inches around corner from each side.
- G. Anchorage: Drill pilot holes for nails where necessary to preclude splitting or chipping of material.
  1. Anchor finish carpentry work to anchorage devices or blocking built-in or directly attached to substrates. Secure to grounds, stripping and blocking with countersunk, concealed fasteners.
- H. Blind nail where possible and use fine finishing nails for exposed nailings, countersunk and filled flush with finished surface.
- I. At exterior locations drive nails flush.

#### **3.04 PREPARATION FOR SITE FINISHING**

- A. Set exposed fasteners. Apply wood filler in exposed fastener indentations. Sand work smooth. Prepare in accordance with level of finish specified in Section 09 9000.
- B. Before installation, prime paint surfaces of items or assemblies to be in contact with cementitious materials.

#### **3.05 TOLERANCES**

- A. Tolerances
  1. Install the work plumb, level, true and straight with no distortions. Conceal shims.
    - a. 1/16-inch maximum offset in flush adjoining surfaces.
    - b. 1/8-inch maximum offset in revealed adjoining surfaces.
  2. Scribe and cut work to fit adjoining work, and refinish cut surfaces or repair damaged finish at cuts.
- B. Maximum Variation from True Position: 1/16 inch (1.6 mm).

#### **3.06 ADJUSTMENT AND FINISHING**

- A. Ease salient corners and edges and sand all exposed surfaces of smooth finish wood.
- B. Repair damaged and defective finish carpentry work wherever possible to eliminate functional and visual defects. Chipped or split materials is considered a defect.
- C. Replace where repair is not possible.
- D. Adjust joinery for uniform appearance.

**END OF SECTION**

**SECTION 06 4100**  
**ARCHITECTURAL WOOD CASEWORK**

**PART 1 GENERAL**

**1.01 SECTION INCLUDES**

- A. Wood Casework
- B. Laminated Plastic Casework
- C. Cabinet Hardware
- D. Preparation for installing utilities.

**1.02 RELATED SECTIONS**

- A. Section 01 6116 - Volatile Organic Compound (VOC) Content Restrictions.
- B. Pertinent sections specifying wall framing, support framing, grounds, and concealed blocking.
- C. Section 06 2000 - Finish Carpentry
- D. Division 09: pertinent sections specifying finishes adjacent to cabinets.
- E. Section 12 3600 - Countertops.
- F. Section 11 4000 - Food Service Equipment.
- G. Pertinent sections specifying plumbing and/or mechanical equipment interfacing cabinets.
- H. Pertinent sections specifying lighting and/or electrical equipment interfacing cabinets.

**1.03 REFERENCE STANDARDS**

- A. AWMAC/WI (NAAWS) - North American Architectural Woodwork Standards, U.S. Version 2.0; 2014.
- B. HPVA HP-1 - American National Standard for Hardwood and Decorative Plywood; 2009.
- C. NEMA LD 3 - High-Pressure Decorative Laminates; 2005.
- D. WI (CCP) - Certified Compliance Program (CCP); current edition at [www.woodworkinstitute.com/certification](http://www.woodworkinstitute.com/certification).
- E. WI (MCP) - Monitored Compliance Program (MCP); current edition at [www.woodworkinstitute.com/certification](http://www.woodworkinstitute.com/certification).
- F. California Code of Regulations, Title 24, Part 2, California Building Code (CBC), International Building Code.
- G. California Code of Regulations, Title 24, Part 11 California Green Building Standards Code, "CAL-Green".
- H. Architectural Woodwork Standards (AWS) latest edition, published jointly by the Woodwork Institute, Architectural Woodwork Institute, and the Architectural Woodwork Manufacturer's Association of Canada.

**1.04 SUBMITTALS**

- A. See Section 01 3300 - Submittals, for submittal procedures.
- B. Shop Drawings: Indicate materials, component profiles, fastening methods, jointing details, and accessories, hardware location and schedule of finishes.

1. Scale of Drawings: 1-1/2 inch to 1 foot (125 mm to 1 m), minimum.
  2. Provide the information required by AWI/AWMAC/WI (AWS) or AWMAC/WI (NAAWS).
  3. Include certification program label indicating that drawings fully meet the requirements of the AWS Millwork Grade specified.
- C. Product Data: Provide data for specified products, including hardware accessories. Demonstrate compliance with specified attributes.
- D. CAL-GREEN Submittals:
1. Product Data - VOC Limits: For adhesives sealants, fillers, primers and coatings, documentation including printed statement of VOC contents, comply with limits specified in related section..
  2. Composite Wood Formaldehyde Limits: Provide certification that all products meet current CARB Airborne Toxic Control Measure (ATCM) for Composite Wood. Formaldehyde Limits by Mandatory Compliance Dates as specified in related section.
  3. Product Data - Low/No-VOC Paints and Coatings. Provide certification that all primers and coatings meet VOC emission limits specified in related section. List manufacturer, brand, application, type (flat or non-flat), number of gallon, and the VOC emissions in grams/liter. Include MSDS and product data sheet indicating VOC limits for each product provided.
- E. Samples:
1. Full range of plastic laminates and edge tapes available from the specified group, of the specified manufacturer.
  2. Submit two samples of each hardware item to be provided, illustrating hardware finish .
  3. Three 12" x 12" finished samples of each veneer species and finish to be used and three 6" x 12" finished samples of each lumber species and finish.
- F. Closeout Submittals: AWS certificates of compliance indicating that installation fully meets requirements of AWS Millwork Grade specified.

#### 1.05 QUALITY ASSURANCE

- A. Fabricator Qualifications: Company specializing in fabricating the products specified in this section with minimum five years of documented experience.
1. Company with at least one project in the past 5 years with value of woodwork within 20 percent of cost of woodwork for this Project.
  2. Accredited participant in the specified certification program prior to the commencement of fabrication and throughout the duration of the project.
- B. Quality Certification:
1. Provide labels or certificates indicating that the installed work complies with AWI/AWMAC/WI (AWS) or AWMAC/WI (NAAWS) requirements for grade or grades specified.
  2. Provide designated labels on shop drawings as required by certification program.
  3. Provide designated labels on installed products as required by certification program.
  4. Submit certifications upon completion of installation that verifies this work is in compliance with specified requirements.
  5. Replace, repair, or rework all work for which certification is refused.
- C. Single Source Responsibility: A single manufacturer shall provide and install the work described in this Section.

#### 1.06 DELIVERY, STORAGE, AND HANDLING

- A. Protect units from moisture damage.

- B. Do not deliver woodwork, until the area of operation is enclosed, painting, wet work, grinding, overhead work and similar operations which could damage, soil or deteriorate woodwork are complete and the area is broom clean.
- C. If woodwork is stored in other than installation areas, store only in areas meeting requirements specified for installation areas.
- D. Do not install woodwork until required temperature and relative humidity are stable and will be maintained in installation areas.

#### **1.07 FIELD CONDITIONS**

- A. During and after installation of custom cabinets, maintain temperature and humidity conditions in building spaces in the range recommended by the Architectural Woodwork Standards for the location of the project.

### **PART 2 PRODUCTS**

#### **2.01 PERFORMANCE REQUIREMENTS**

- A. VOC Limits for adhesives, sealants, fillers, primers and coatings . Comply with limits specified in related section.
- B. Composite Wood products must meet current CARB Airborne Toxic Control Measure (ATCM) for Composite Wood Formaldehyde Limits by Mandatory Compliance Dates as specified in related section.

#### **2.02 MANUFACTURERS**

- A. Single Source Responsibility: Provide and install this work from single fabricator.

#### **2.03 CABINETS**

- A. Quality Grade: Unless otherwise indicated provide products of quality specified by AWI//AWMAC/WI (AWS) for Grades as indicated. Refer to SCHEDULES article.
  - 1. Provide Custom Grade minimum.
- B. Wood Veneer Faced Cabinets:
  - 1. Exposed Surfaces: HPVA HP-1 Grade A, Ash, plain sliced, random-matched.
  - 2. Semi-Exposed Surfaces: HPVA HP-1 Grade B, Ash, plain sliced, random-matched.
- C. Plastic Laminate Faced Cabinets:
  - 1. Exposed Interior Surfaces: Low Pressure Melamine in a pattern or color compatible with the exposed surfaces unless otherwise noted.
  - 2. Semi-Exposed Surfaces: White melamine.
- D. Cabinets:
  - 1. Door and Drawer Front Edge Profiles: Square edge with thin applied band.
    - a. Door and drawer fronts shall be 3/4 inch thick.
  - 2. Backs shall be full 3/4 inch thick.
  - 3. Casework Construction Type: Type A - Frameless.
  - 4. Interface Style for Cabinet and Door: Style 1 - Overlay; reveal overlay.
    - a. Where doors are notched for hinges seal exposed edges of core with paint to match adjacent panel surface.
  - 5. Cabinet Design Series: As indicated on drawings.
    - a. Fabricate cabinets with openings and mortises precut, to receive hardware, appliances, plumbing, fixtures, electrical work and similar items.
    - b. Smooth edges of cutoffs and, where located in countertops and similar exposures, seal edges of cutouts with a water resistant coating.
  - 6. Adjustable Shelf Loading: 50 lbs. per sq. ft..



- a. Deflection: L/144.
- b. Shelves over 36 inch in length, fixed or adjustable, shall be 1 inch thick.
7. Cabinet Doors and Drawer Fronts: Flush style.
8. Drawer Side Construction: Multiple-dovetailed.

#### **2.04 WOOD-BASED COMPONENTS**

- A. Wood fabricated from old growth timber is not permitted.

#### **2.05 LUMBER MATERIALS**

- A. Wood Moisture Content: Comply with requirements of referenced quality standard for moisture content of lumber at time of fabrication and for relative humidity conditions in the installation areas.
- B. Hardwood Lumber: graded in accordance with WI Manual of Millwork,, Grade II/Custom; average moisture content of 4-9 percent; species and grade as follows, locations indicated:

#### **2.06 PANEL MATERIALS**

- A. Particleboard: Not permitted. Do not use.
- B. Acceptable Medium Density Fiberboard Manufacturers:
  1. Roseburg, Springfield, OR; tel: (800) 245-1115, web: [www.roseburg.com](http://www.roseburg.com).
  2. Substitutions: See Section 01 6000 - Product Requirements.
- C. Medium Density Fiberboard (MDF) Panels: ANSI A208.2, Grade 155. No added formaldehyde. Medite II MDF as follows;
  1. Faces not required to be HPDL or wood veneer may be melamine, polyester or high-pressure laminate at fabricator's option. Color selected by Architect from full range of manufacturer's options, minimum of three choices.
  2. Composition: Lignocellulosic fibers and formaldehyde-free synthetic resin.
  3. Density: 44 to 49 lb/cu ft.
  4. Thickness: 1/4 to 1-1/4 inches, as indicated on drawings or as required by referenced standard for conditions indicated or necessary.
  5. Formaldehyde Content: Certified by Scientific Certification Systems to be made without use of phenol formaldehyde and to contain not more than 0.05 ppm formaldehyde.
  6. Force to Withdraw Screws at Panel Face: 225 pounds minimum, No.10 sheet metal screw.
  7. Force to Withdraw Screws at Panel Edge: 200 pounds minimum, No.10 sheet metal screw.
  8. Recycled Wood Content: Certified by Scientific Certification Systems for pre-consumer recycled wood fiber content
- D. Medium Density Fiberboard (MDF) Panels - Moisture Resistant Types, Provide at Sinks and Interior High Moisture Areas: ANSI A208.2, Grade 155. No added formaldehyde, SierraPine Medex MDF as follows;
  1. Meet all requirements specified above for Medium Density Fiberboard (MDF) Panels and the following:
    - a. Moisture-Resistant Panels: Withstanding the Accelerated Aging Tests specified in ASTM D 1037 without adverse effects.
- E. Hardwood Veneer Faced Panels: Particleboard or Medium Density Fiberboard of indicated type with following facings:
  1. Wood Veneer Facing for Transparent Finish: Species as specified above, veneer grade as specified above, veneer cut as specified above, book veneer match, running assembly match; unless otherwise indicated.
  2. Backing Sheet: Hardwood.
  3. Minimum Thickness, Face and Backing Sheets: 0.02 inch.

4. Edge Trim: Custom grade solid hardwood in species and cut to match face sheet.
5. Transparent Factory Finish: WI Custom grade, catalyzed lacquer, WI Finish 3A, clear.

## 2.07 LAMINATE MATERIALS

- A. Manufacturers:
  1. Wilsonart International, Inc: [www.wilsonart.com](http://www.wilsonart.com).
  2. Substitutions: See Section 01 6000 - Product Requirements.
- B. High Pressure Decorative Laminate (HPDL): NEMA LD 3, types as recommended for specific applications.
- C. Provide specific types as indicated.
  1. Horizontal Surfaces: HGS, 0.048 inch (1.22 mm) nominal thickness, through color, color as selected, finish as selected.
  2. Vertical Surfaces: VGS, 0.028 inch (0.71 mm) nominal thickness, through color, \_\_\_\_\_ color, finish as indicated.
  3. Post-Formed Horizontal Surfaces: HGP, 0.039 inch (1.0 mm) nominal thickness, through color, color as selected, finish as indicated.
  4. Post-Formed Vertical Surfaces: VGP, 0.028 inch (0.71 mm) nominal thickness, through color, color as selected, finish as indicated.
  5. Flame Retardant Surfaces: HGF, 0.048 inch (1.22 mm) nominal thickness, through color, color as selected, finish as indicated.
  6. Cabinet Liner: CLS, 0.020 inch (0.51 mm) nominal thickness, through color, \_\_\_\_\_ color, finish as indicated.
  7. Laminate Backer: BKL, 0.020 inch (0.51 mm) nominal thickness, undecorated; for application to concealed backside of panels faced with high pressure decorative laminate.
- D. Colors, Patterns, and Finishes: As indicated in drawings.

## 2.08 COUNTERTOPS

- A. General: Types specified in Section 12 3600. Provide in accordance with WI Manual Sections cited to match quality grade(s) for cabinets indicated in this Section.

## 2.09 ACCESSORIES

- A. Adhesive: Type recommended by WI to suit application, urea formaldehyde-free.
  1. Wood Glue: Waterproof types as recommended by WI standards for the particular application. VOC content of not more than 30 g/L when calculated according to 40 CFR 59, Subpart D (EPA method 24).
  2. Adhesive for Bonding Plastic Laminate: Contact cement, for general use and for postforming. Use unpigmented product with through-color laminate.
- B. Plastic Edge Banding: Extruded PVC, flat shaped; smooth finish; self locking serrated tongue; of width to match component thickness. 3 mm thick, minimum.
  1. Color: As selected by Architect from manufacturer's full range.
    - a. Provide minimum of seventy-five color selections coordinated with plastic laminate selections, including patterns and woodgrains.
- C. Glass Shelves and Cabinet Door Inserts: Tempered Float Glass, ASTM C 1048, Kind FT, Condition A, Type I, Class 1 (clear) or obscure type as indicated, Quality-Q3, with exposed edges seamed before tempering, 6 mm thick minimum and thicker as indicated on drawings.
- D. Fasteners: Size and type to suit application.

- E. Bolts, Nuts, Washers, Lags, Pins, and Screws: Of size and type to suit application; galvanized or chrome-plated finish in concealed locations and stainless steel or chrome-plated finish in exposed locations.
- F. Concealed Joint Fasteners: Threaded steel.
- G. Grommets: plastic material for cut-outs, 2 inch diameter minimum, color as selected.

## 2.10 HARDWARE

- A. General: Meet or exceed specified requirements of AWI/AWMAC/WI - Architectural Woodwork Standards (AWS) and BHMA Grade 1; US 26D finish or as selected by Architect from manufacturer's standards.
- B. Shelf Support Clips: Plated steel, ANSI/BHMA A156.9, meet or exceed Grade 1 B04013, with support pin for drilled hole in cabinet standard and shelf, with pre-drilled hole for seismic fastener to shelf. Hettich Sekura #1, US Futaba 72511 52 068, or equal. Plastic clips will be rejected.
- C. Door and Drawer Pulls: Provide at all doors and drawers, matte stainless steel, 96 (hole spacing) x 35 mm loop pull; Hafele, San Francisco, CA "Model 115.61.601, or equal .
- D. Cabinet Locks: Provide at all cabinets and drawers except sink cabinets. Locks to be keyed cylinder, two keys per lock, master keyed, steel with chrome finish.
- E. Catches: Magnetic.
- F. Drawer Slides:
  - 1. Type: Extension types as indicated.
  - 2. Static Load Capacity: Heavy Duty grade and minimum capacity ratings as follows;
    - a. File Drawers: Extra Heavy Duty grade 125 pounds.
    - b. Lateral File Drawers: Extra Heavy Duty grade 150 pounds.
    - c. Lateral File Drawers More Than 30" Wide: Extra Heavy Duty grade 200 pounds.
    - d. Drawers in excess of 36 inches wide: Extra Heavy Duty grade 150 pounds.
    - e. Pencil Drawers (less than 4 inches inside height): 50 pounds.
    - f. All other drawers: 75 pounds.
  - 3. Mounting: Side mounted.
  - 4. Stops: Integral type.
  - 5. Features: Provide self closing/stay closed type.
  - 6. Manufacturers:
    - a. Accuride International, Inc; Heavy-Duty Drawer Slides: [www.accuride.com/#sle](http://www.accuride.com/#sle).
    - b. Grass America Inc; Ball Bearing Slide System: [www.grassusa.com/#sle](http://www.grassusa.com/#sle).
    - c. Hettich America, LP: [www.hettich.com/#sle](http://www.hettich.com/#sle).
    - d. Knappe & Vogt Manufacturing Company: [www.knapeandvogt.com/#sle](http://www.knapeandvogt.com/#sle).
    - e. Substitutions: See Section 01 6000 - Product Requirements.
- G. Hinges: Stainless steel, five knuckle ANSI / BHMA Grade 1, non-removable pins, attached with screws that are inaccessible when closed, capable of 270 degree swing. Finish as selected by Architect. European style concealed hinges will be rejected.
  - 1. Manufacturer: Rockford Process Control "No. 376" or equal.
  - 2. Substitutions: See Section 01 6000 - Product Requirements.
- H. Latches: Finger-release type; Locate release not exceeding 40 inches above finish floor elevation, on either leaf of pair doors, to suit configurations shown.
- I. Grommets and covers: 2 inch diameter, ABS plastic; color as selected.
- J. File frames and followers: Pendaflex type at each drawer indicated as file drawer.

- K. Other Hardware: per referenced standard.

## **2.11 FABRICATION**

- A. Assembly: Shop assemble cabinets for delivery to site in units easily handled and to permit passage through building openings.
- B. Edging: Fit shelves, doors, and exposed edges with specified edging. Do not use more than one piece for any single length.
  - 1. Cap exposed plastic laminate countertop finish ends and edges with material of same finish and pattern. Cap semi-exposed ends and edges with materials permitted by the Referenced Standard. Plastic Tee banding is not acceptable.
  - 2. Plastic Laminate Faced Cabinet Edge Band: 3mm PVC at doors, drawer fronts, false fronts, and at all other edges requiring banding.
  - 3. Wood Faced Cabinet Edge Band: 3mm wood edge band at doors, drawer fronts and false fronts, all other edges per the AWS.
- C. Fitting: When necessary to cut and fit on site, provide materials with ample allowance for cutting. Provide matching trim for scribing and site cutting.
- D. Plastic Laminate: Apply plastic laminate finish in full uninterrupted sheets consistent with manufactured sizes. Fit corners and joints hairline; secure with concealed fasteners. Locate counter butt joints minimum 6 feet (\_\_\_ mm) from sink cut-outs.
- E. Provide cutouts for plumbing fixtures. Verify locations of cutouts from on-site dimensions. Seal cut edges.

## **2.12 FABRICATION - COUNTERTOPS**

- A. Fabricate countertops as specified in Section 12 3600 and to match quality grade standards specified in this section. In the event of conflict, the higher standard prevails.

## **2.13 SOURCE QUALITY CONTROL**

- A. Labels: Certification of compliance, affixed by WI Inspector at the place of fabrication prior to shipment.

## **2.14 FACTORY FINISHING FOR WOOD CABINETS**

- A. Sand work smooth and set exposed nails and screws.
- B. For opaque finishes, apply wood filler in exposed nail and screw indentations and sand smooth.
- C. On items to receive transparent finishes, use wood filler matching or blending with surrounding surfaces and of types recommended for applied finishes.
- D. Finish work in accordance with AWI/AWMAC/WI (AWS) or AWMAC/WI (NAAWS), Section 5 - Finishing for grade specified and as follows:
  - 1. Transparent - Standard:
    - a. System - 3, Lacquer, Postcatalyzed.
    - b. Stain and Sheen: As selected by Architect.
    - c. Products:
      - 1) Fabricator's option, any product complying with specified requirements.
  - 2. Opaque:
    - a. System - 3, Lacquer, Postcatalyzed.
    - b. Color and Sheen: As selected by Architect.
    - c. Products:
      - 1) Fabricator's option, any product complying with specified requirements.

### **PART 3 EXECUTION**

#### **3.01 EXAMINATION**

- A. Verify location of blocking, adequacy of backing and support framing.
- B. Verify location and sizes of utility rough-in associated with work of this section.

#### **3.02 INSTALLATION**

- A. Set and secure casework in place; rigid, plumb, and level, free of distortions. Shim as required; use concealed shims.
- B. Use fixture attachments in concealed locations wherever possible for wall mounted components. Exposed fasteners at semi-exposed surfaces and exposed interior surfaces are acceptable when required to provide a seismic compliant installation.
  - 1. Exception: Exposed fastening permitted at access panels.
- C. Use concealed joint fasteners to align and secure adjoining cabinet units.
- D. Carefully scribe casework abutting other work, with maximum gaps of 1/32 inch (1 mm). Do not use additional overlay trim for this purpose.
- E. Secure cabinets to floors and walls using appropriate angles and anchorages.
- F. Wood Cabinets for Transparent Finish: Countersink anchorage devices at exposed locations. Conceal with solid wood plugs of species to match surrounding wood; finish flush with surrounding surfaces.
  - 1. Countersink and fill flush with woodwork.
  - 2. Match final finish where transparent finish is indicated.
- G. Shelves: Install adjustable shelves evenly spaced, with specified hardware. Securely attach shelves to earthquake clips.
- H. Countertops: Anchor securely to base units and other support systems and as specified in Section 12 3600.
- I. Connection of sinks to plumbing systems as specified in pertinent related sections.

#### **3.03 TOLERANCES.**

- A. Site Tolerances: 1/8 inch in 8 feet for plumb and level; adjoining surfaces flush, without offset.
- B. Cabinet Tolerances: As specified in the referenced standard.

#### **3.04 ADJUSTING**

- A. Adjust installed work.
  - 1. Adjust and lubricate moving or operating parts to function smoothly and correctly.
  - 2. Adjust hardware to center doors and drawers in openings and to provide smooth operation.
- B. Touch-up shop-applied finishes to restore damaged or soiled areas.
- C. Repair damaged and defective woodwork and eliminate defects functionally and visually. Where repair is not possible replace woodwork. Adjust joinery for uniform appearance.

#### **3.05 FIELD QUALITY CONTROL**

- A. If Architect questions that installation quality may not conform to the specified AWS Quality Grade, Architect may order a final inspection by a WI Inspector.

**3.06 CLEANING**

- A. Clean casework, counters, shelves, hardware, fittings, and fixtures.

**3.07 PROTECTION OF FINISHED WORK**

- A. Do not permit finished casework to be exposed to continued construction activity.
- B. Do not store materials or products on countertops. Do not stand or walk on countertops or use for construction access to building elements above floor level.
- C. Protect countertops with durable panel materials secured in place using methods which will not damage surfaces or finishes. Do not remove until Owner acceptance following move-in.

**3.08 SCHEDULES**

- A. All Other Locations:
  - 1. Quality: WI Custom Grade.
  - 2. Cabinet Construction: Plastic laminate faced.
  - 3. Countertops: Plastic laminate.

**END OF SECTION**

**SECTION 06 8316  
FIBERGLASS REINFORCED PANELING**

**PART 1 GENERAL**

**1.01 SECTION INCLUDES**

- A. Fiberglass reinforced plastic panels.
- B. Trim.

**1.02 RELATED REQUIREMENTS**

- A. Section 01 6116 - Volatile Organic Compound (VOC) Content Restrictions.

**1.03 REFERENCE STANDARDS**

- A. ASTM D256 - Standard Test Methods for Determining the Izod Pendulum Impact Resistance of Plastics; 2010.
- B. ASTM D2583 - Standard Test Method for Indentation Hardness of Rigid Plastics by Means of Barcol Impressor; 2013a.
- C. ASTM D3273 - Standard Test Method for Resistance to Growth of Mold on the Surface of Interior Coatings in an Environmental Chamber; 2012.
- D. ASTM D5319 - Standard Specification for Glass-Fiber Reinforced Polyester Wall and Ceiling Panels; 2012.
- E. ASTM E84 - Standard Test Method for Surface Burning Characteristics of Building Materials; 2015a.
- F. FDA Food Code - Chapter 6 - Physical Facilities; current edition with Supplements, if any.
- G. FM 4880 - Class 1 Fire Rating of Insulated Wall or Wall and Roof/Ceiling Panels, Interior Finish Materials or Coatings and Exterior Wall Systems; 2010.
- H. ISO 846 - Plastics - Evaluation of the Action of Microorganisms; 1997.
- I. ISO 2812-1 - Paints and Varnishes - Determination of resistance to liquids - Part 1: Immersion in liquids; 2007.
- J. California Code of Regulations, Title 24, Part 2, California Building Code (CBC), International Building Code.
- K. California Code of Regulations, Title 24, Part 11, California Green Building Standards Code, "CAL-Green".

**1.04 SUBMITTALS**

- A. General: Submit in accordance with Section 01 3300.
- B. Provide complete submittals at the same time as submittals for work in related sections to permit review of complete and integrated systems and assemblies.
- C. Product Data: Provide data on specified products, describing physical and performance characteristics; including sizes, patterns and colors available; and installation instructions. Demonstrate compliance with specified attributes.

- D. CAL-GREEN Submittals: Product Data – VOC Limits: For adhesives sealants, fillers, primers and coatings, documentation including printed statement of VOC contents, comply with limits specified in related section.
- E. Samples: Submit two samples \_\_6 inches\_\_by\_6 inches\_\_ inch (\_\_\_\_by\_\_\_\_ mm) in size illustrating material and surface design of panels.
- F. Maintenance Materials: Furnish the following for Owner's use in maintenance of project.
  - 1. See Section 01 6000 - Product Requirements, for additional provisions.
  - 2. Extra Panels: Quantity equal to 5 percent of total installed.

#### **1.05 DELIVERY, STORAGE, AND HANDLING**

- A. Store panels flat, indoors, on a clean, dry surface. Remove packaging and allow panels to acclimate to room temperature for 48 hours prior to installation.

### **PART 2 PRODUCTS**

#### **2.01 PERFORMANCE REQUIREMENTS**

- A. VOC Limits for adhesives, sealants, fillers, primers and coatings . Comply with limits specified in related section.

#### **2.02 MANUFACTURERS**

- A. Fiberglass Reinforced Plastic Panels:
  - 1. Crane Composites, Inc; Sequentia: [www.cranecomposites.com](http://www.cranecomposites.com).
  - 2. Marlite: [www.marlite.com](http://www.marlite.com).
  - 3. Nudo: [www.nudo.com](http://www.nudo.com).
  - 4. Substitutions: See Section 01 6000 - Product Requirements.

#### **2.03 PANEL SYSTEMS**

- A. Wall Panels:
  - 1. Panel Size: 4 by 8 feet (1.2 by 2.4 m).
  - 2. Panel Thickness: 0.10 inch (2.5 mm).
  - 3. Surface Design: Embossed.
  - 4. Color: As selected by Architect.
  - 5. Attachment Method: Adhesive only, sealant joints, no trim.

#### **2.04 MATERIALS**

- A. Panels: Fiberglass reinforced plastic (FRP), complying with ASTM D5319.
  - 1. Surface Burning Characteristics: Maximum flame spread index of 25 and smoke developed index of 450; when system tested in accordance with ASTM E84.
  - 2. Class 1 fire rated when tested in accordance with FM 4880.
  - 3. Mold Resistance: Score of 10, when tested in accordance with ASTM D3273.
  - 4. Scratch Resistance: Barcol hardness score greater than 35, when tested in accordance with ASTM D2583.
  - 5. Impact Strength: Greater than 6 ft lb force per inch (320 J per m), when tested in accordance with ASTM D256.
  - 6. Surface Characteristics and Cleanability: Provide products that are smooth, durable, and easily cleanable, in compliance with FDA Food Code, Chapter 6 - Physical Facilities.
  - 7. Chemical Cleanability: Excellent chemical resistance to common cleaners and detergents when tested in accordance with ISO 2812-1.
  - 8. Biological Resistance: Rating of 0, when tested in accordance with ISO 846.



- B. Trim: Vinyl; color coordinating with panel.
- C. Fasteners: Nylon rivets.
- D. Adhesive: Type recommended by panel manufacturer.
- E. Sealant: Silicone; white, type specified in Section 07 9200 for interior applications.

## **2.05 FINISHES**

- A. Color(s) as selected by Architect from:
  - 1. Manufacturer's full range of standard colors.

## **PART 3 EXECUTION**

### **3.01 EXAMINATION**

- A. Verify existing conditions and substrate flatness before starting work.
- B. Verify that substrate conditions are ready to receive the work of this section.

### **3.02 INSTALLATION - WALLS**

- A. Install panels in accordance with manufacturer's instructions.
- B. Cut and drill panels with carbide tipped saw blades, drill bits, or snips.
- C. Pre-drill fastener holes in panels, 1/8 inch (3.2 mm) greater in diameter than fastener, spaced as indicated by panel manufacturer.
- D. Apply adhesive to the back side of the panel using trowel as recommended by adhesive manufacturer.
- E. Apply panels to wall with seams plumb and pattern aligned with adjoining panels.
- F. Install panels with manufacturer's recommended gap for panel field and corner joints.
- G. Drive fasteners to provide snug fit, and do not over-tighten.
- H. Place trim on panel before fastening edges, as required.
- I. Fill channels in trim with sealant before attaching to panel.
- J. Install trim with adhesive and screws or nails, as required.
- K. Seal gaps at floor, ceiling, and between panels with applicable sealant to prevent moisture intrusion.
- L. Remove excess sealant after paneling is installed and prior to curing.

**END OF SECTION**

**SECTION 07 0150.19**  
**PREPARATION FOR RE-ROOFING**

**PART 1 GENERAL**

**1.01 SECTION INCLUDES**

- A. Removal of existing roofing system in preparation for a new roof membrane or shingle system.
- B. Salvaging, storing, and protecting existing work to remain or to be removed and re-installed.
  - 1. Refer to items scheduled at end of the section.

**1.02 RELATED REQUIREMENTS**

- A. Section 01 1100- Summary: Work sequence and continued occupancy of the building.
- B. Section 01 5000 - Temporary Facilities and Section 01 5600 Controls: Temporary enclosures, dust control barricades, security at occupied areas, and cleanup during construction.
- C. Section 06 1000 - Rough Carpentry.
- D. Section 01 7513 - Execution Requirements: Re-installation of removed components.
- E. Section 07 5550 - Modified Bitumen Roofing.

**1.03 PROJECT CONDITIONS**

- A. Conform to applicable regulatory procedures when hazardous or contaminated materials are discovered.
- B. Schedule work to coincide with commencement of installation of new roofing system.
- C. Remove only existing roofing materials that can be replaced with new materials as the weather will permit.
- D. Coordinate the work with other affected mechanical and electrical work associated with roof penetrations.
- E. Do not disable or disrupt building fire or life safety systems without 10 (ten) days' prior written notice to Owner.
- F. Do not close or obstruct egress from any building exit or site exit.
- G. Conduct roof removal to minimize interference with adjacent and occupied building areas.
- H. Use all means necessary to protect existing objects, construction and plantings designated to remain. In the event of damage, make all repairs and replacements necessary for approval of Architect at no additional cost to the Owner.
- I. Protective measures: Provide all necessary safeguards, including warning signs and lights, barricades, and the like, for protection of the public, Contractor's employees and existing improvements during demolition. Prevent access of unauthorized persons to area of work
- J. Provide at least one person who shall be present at all times during execution of this portion of the work, be thoroughly familiar with the type of work being performed and the best methods for its execution and who shall direct all work performed under this Section.

- K. Control the use of water to prevent damage to the existing facilities to remain. Provide wet vacuum equipment where water, such as waste cooling water from concrete sawing or water used as dust emollient, is used adjacent to and in existing buildings.
- L. Cease operations immediately if structure appears to be in danger and notify Architect. Do not resume operations until directed.

#### **1.04 SCHEDULING**

- A. Schedule work under the provisions of Section 01 3200.
- B. Schedule work to coincide with new construction.
- C. Coordinate preparation for roofing with other trades to assure the proper sequence, limits, methods and time of performance. Schedule work so as to impose a minimum of hardship on the present operation of facilities and the performance of the work of other trades or contracts.
- D. Describe removal procedures and schedule.
- E. Perform noisy, malodorous, or dusty work:
  - 1. Between the hours of 7:00 am and 5:00 pm.

#### **1.05 FIELD CONDITIONS**

- A. Do not remove existing roofing membrane when weather conditions threaten the integrity of building contents or intended continued occupancy.
- B. Maintain continuous temporary protection prior to and during installation of new roofing system.

#### **1.06 SUBMITTALS**

- A. Per California State Assembly Bill No. 635, Chapter 438 the following entities must submit the following certificates of disclosure;
  - 1. Prior to the time professional services are engaged an architect, engineer, or roofing consultant who provides professional services to a repair or re-roofing project, shall disclose any financial relationships by completing and signing the certification letter attached to this section.
  - 2. At the award of the construction contract, the materials manufacturer, the contractor, or the vendor involved in a bid or proposal for repair or re-roofing project, shall disclose any financial relationships by completing and signing the certification letters attached to this section.

### **PART 2 PRODUCTS**

#### **2.01 COMPONENTS**

- A. Refer to following sections for additional information on components relating to this work:

#### **2.02 MATERIALS**

- A. Temporary Protection: Sheet polyethylene; provide weights and temporary fasteners to retain sheeting in position.

### **PART 3 EXECUTION**

#### **3.01 EXAMINATION**

- A. Verify that existing roof surface has been cleared of materials being removed from existing roofing system and ready for next phase of work as required.

### **3.02 PREPARATION**

- A. Provide, erect, and maintain temporary barriers at locations required to prevent unauthorized access to area of work.
- B. Inspect the area of work and verify locations of all items designated to be removed or preserved.
- C. Do not begin work until temporary barricades, warning signs and other forms of protection are installed.
- D. Erect and maintain weatherproof closures for exterior openings.
- E. Erect and maintain temporary partitions to prevent spread of dust, odors, and noise to permit continued occupancy of adjacent buildings.
- F. Protect existing equipment, materials and features that are not to be demolished or removed for re-installation.
- G. Prevent movement of structure; provide bracing and shoring.
  - 1. Be responsible for the adequacy and design of all temporary shoring and bracing systems.
- H. Notify affected utility companies before starting work and comply with their requirements.
  - 1. Mark location and termination of utilities.
  - 2. Provide appropriate temporary signage including signage for exit or building egress.
- I. Sweep roof surface clean of loose matter.
- J. Remove loose refuse and dispose of properly off-site.

### **3.03 MATERIAL REMOVAL**

- A. Disconnect, cap, and identify designated utilities within removal areas.
- B. Remove skylights, hatches, exhaust fans, hoods and similar items. Store and protect elements identified for re-installation.
- C. Securely cover roof penetration openings where items have been removed. Prevent intrusion of water, weather, foreign objects, or roofing materials into building.
- D. Remove metal counter flashings.
- E. Scrape roofing gravel from membrane surface without causing serious damage to membrane felts.
- F. Remove roofing membrane, shingles, perimeter base flashings, flashings around roof protrusions, pitch pans and pockets.
- G. Remove damaged insulation and fasteners, cant strips, blocking, and related items.
- H. Repair existing wood deck surface to provide smooth working surface for new roof system.
- I. Work not mentioned to be removed that interferes with new construction shall be cut to clean cut lines to provide for proper interface with new construction, or patching and repair, as required for scope of work indicated.

**3.04 INSTALLATION**

**3.05 PROTECTION**

- A. Provide temporary protective sheeting over uncovered deck surfaces.
- B. Turn sheeting up and over parapets and curbing. Retain sheeting in position with temporary fasteners.
- C. Provide for surface drainage from sheeting to existing drainage facilities.
- D. Do not permit traffic over unprotected or repaired deck surface.

**3.06 SALVAGE**

- A. Items indicated to be re-installed shall be removed carefully, cleaned and stored in a protected location on or off the site until re-installed.

**3.07 PATCHING**

- A. Patch materials to remain when damaged by this work. Finish materials and appearance of the patch or repair work shall match the existing contiguous materials and finishes in all respects and shall be approved by Architect.
- B. Where materials are removed oversize or in improper location, replace the excess removed material as instructed by Architect at no additional cost to the Owner.

**3.08 RE-INSTALLATION**

- A. Re-Install removed items as indicated under provisions of Section 01 7500. Securely attach, provide watertight, weatherproof installation.

**3.09 CLEAN-UP AND DISPOSAL**

- A. Debris, waste, and removed materials, other than items to be salvaged, are Contractor's property for legal disposal off the site, as required by applicable Federal and State regulations. Continuously clean up and remove these items. Do not allow removed items to accumulate.
- B. Leave the site in a neat and orderly condition prepared for the work of other trades.

**3.10 SCHEDULES**

- A. Entire Roofing Area: Remove existing roofing gravel, perimeter flashings, base flashings, counter flashings, vent stack flashings, roofing membrane, insulation, vapor retarder, and related items.
- B. Remove roof mounted smoke vent hatches, attic vents, and mechanical equipment and electrical equipment as necessary to allow access to roof surfaces for re-roofing. Re-install following completion of re-roofing activities. Confirm water-tight installation and all required functional and operational characteristics upon completion.

**3.11 APPENDIX - LETTERS OF DISCLOSURE**

- A. Architect, Engineer or Roofing Contractor Certificate of Disclosure Letter.
- B. Materials Manufacturer, Contractor or Vendor Certificate of Disclosure Letter.

**END OF SECTION**

**SECTION 07 2100**  
**BOARD AND BATT [BUILDING] INSULATION**

**PART 1 GENERAL**

**1.01 SECTION INCLUDES**

- A. Batt insulation and vapor retarder in interior and exterior wall, ceiling, roof, and floor construction.
- B. Insulation for filling perimeter window and door shim spaces and crevices in exterior wall and roof.

**1.02 RELATED REQUIREMENTS**

- A. Section 01 6116 - Volatile Organic Compound (VOC) Content Restrictions.
- B. Section 07 8400 - Firestopping: Insulation as part of fire-rated through-penetration assemblies.
- C. Division 23 - Mechanical, Duct and Pipe Insulation.

**1.03 REFERENCE STANDARDS**

- A. ASTM C665 - Standard Specification for Mineral-Fiber Blanket Thermal Insulation for Light Frame Construction and Manufactured Housing; 2012.
- B. ASTM E84 - Standard Test Method for Surface Burning Characteristics of Building Materials; 2015a.
- C. ASTM E136 - Standard Test Method for Behavior of Materials in a Vertical Tube Furnace At 750 Degrees C; 2012.
- D. California Code of Regulations, Title 24, Part 2, California Building Code (CBC), International Building Code.
- E. California Code of Regulations, Title 24, Part 11 California Green Building Standards Code, "CAL-Green".
- F. Manufacturer's recommendations.

**1.04 SUBMITTALS**

- A. See Section 01 3300 - Submittals, for submittal procedures.
- B. Product Data: Provide data on product characteristics, performance criteria, and product limitations.
- C. CAL-GREEN Submittals:
  - 1. Product Data - VOC Limits: For adhesives sealants, fillers, primers and coatings, documentation including printed statement of VOC contents, comply with limits specified in related section.
  - 2. Certify compliance with 2019 California Referenced Standards Code as referenced in Article PERFORMANCE REQUIREMENTS.
- D. Manufacturer's Installation Instructions: Include information on special environmental conditions required for installation and installation techniques.
- E. Schedule of installation methods for each and every system and condition.
- F. Samples of mechanical supports and fasteners.

### 1.05 FIELD CONDITIONS

- A. Do not install insulation adhesives when temperature or weather conditions are detrimental to successful installation.

### 1.06 SEQUENCING

- A. Sequence work to ensure fireproofing and firestop materials are in place before beginning work of this section.

### 1.07 DELIVERY, STORAGE AND HANDLING

- A. Mark materials on face of package, with manufacturer's name, thickness, and insulation "R" value.

## PART 2 PRODUCTS

### 2.01 PERFORMANCE REQUIREMENTS

- A. VOC Limits for adhesives, sealants, fillers, primers and coatings . Comply with limits specified in related section.
- B. Insulating Material Standards: All insulation materials must comply with the 2019 California Referenced Standards Code, California Code of Regulations, Title 24, Part 12 / Chapter 12-13 Standards for Insulating Material.
- C. Roof and wall insulation to provide a complete insulation envelope surrounding all conditioned spaces, as indicated elsewhere in the Contract Documents, and as listed below.

### 2.02 APPLICATIONS

- A. Insulation in Wood Framed Exterior Walls: Batt insulation with integral vapor retarder.
  - 1. Wood Framed Wall Insulation: Minimum R-19 fiberglass batts with vapor retarder facing, fastened to wood studs, and greater thicknesses as required to fill framing cavity with insulation batt equal to full depth of framing member.
- B. Insulation in Interior Framed Walls: Unfaced Batt Insulation with no vapor retarder to full depth of framing member, at all wall locations.

### 2.03 BATT INSULATION MATERIALS

- A. Glass Fiber Batt Insulation: ASTM C 665; flexible preformed glass fiber batt; friction fit, sized to fit between framing elements, conforming to the following:
  - 1. Flame Spread Index: 25 or less, when tested in accordance with ASTM E84.
  - 2. Smoke Developed Index: 450 or less, when tested in accordance with ASTM E84.
  - 3. Combustibility: Non-combustible, when tested in accordance with ASTM E136, except for facing, if any.
  - 4. Formaldehyde Content: Zero.
  - 5. Thermal Resistance: R value as indicated.
  - 6. Facing: FSK (Foil-Scrim Kraft), one side. Exception: Paper facing may be provided in locations where the insulation is in "substantial contact" with the wall finish as described in exceptions noted in CBC 719.2.1.
  - 7. Maximum 0.50 perm rating, ASTM E 96.
  - 8. Manufacturers:
    - a. Johns Manville International, Inc: [www.jm.com](http://www.jm.com).
    - b. CertainTeed Corporation: [www.certainteed.com](http://www.certainteed.com).
    - c. Owens Corning Corp: [www.owenscorning.com](http://www.owenscorning.com).
    - d. Substitutions: See Section 01 6000 - Product Requirements.

- B. Acoustic Batt (Sound Retardant) Insulation:
  - 1. Same as Batt Insulation, unfaced.

#### **2.04 OTHER INSULATION**

- A. Foamed-in-place Plastic Insulation: Polyurethane Foam Sealant, Flame Spread 20 / Smoke Developed 20, when tested in accordance with ASTM E 84.
  - 1. Manufacturers:
    - a. Dow Chemical Co.; Great Stuff: [www.itsgreatstuff.dow.com](http://www.itsgreatstuff.dow.com). UL Listed R 13655.
    - b. Substitutions: See Section 01 6000 - Product Requirements.

#### **2.05 ACCESSORIES**

- A. Attachment clips as recommended by the manufacturer in writing.
- B. Tape: Bright aluminum self-adhering type, mesh reinforced, 2 inch (50 mm) wide.
- C. Insulation Fasteners: Impaling clip of unfinished steel with washer retainer and clips, to be adhered to surface to receive insulation, length to suit insulation thickness and substrate, capable of securely and rigidly fastening insulation in place.
- D. Nails or Staples: Steel wire; electroplated or galvanized; type and size to suit application.
- E. Adhesive: Type recommended by insulation manufacturer for application.

### **PART 3 EXECUTION**

#### **3.01 EXAMINATION**

- A. Verify that substrate, adjacent materials, and insulation materials are dry and that substrates are ready to receive insulation.
- B. Verify that all framing inspections are complete and that required corrections have been made before installing insulation.

#### **3.02 INSTALLATION - GENERAL**

- A. Install insulation in accordance with manufacturer's instructions.
- B. Install in walls, roof and ceiling spaces without gaps or voids. Do not compress insulation.
- C. Trim insulation neatly to fit spaces. Fit insulation tight in spaces and tight to exterior side of mechanical and electrical services within the plane of insulation.
- D. Small gaps and voids which are not otherwise insulatable:
  - 1. Either sprayed foam type plastic insulation or mineral wool, as recommended by the Contractor and approved by the Architect.
  - 2. Provide bond breaking material between foam and adjacent materials wherever possible.
- E. Install with factory applied vapor retarder membrane facing warm side of building spaces.

#### **3.03 BATT INSTALLATION**

- A. Install insulation and vapor retarder in accordance with manufacturer's instructions.
- B. Install in exterior wall, roof, and ceiling spaces without gaps or voids. Do not compress insulation.
- C. Trim insulation neatly to fit spaces. Insulate miscellaneous gaps and voids.



- D. Fit insulation tightly in cavities and tightly to exterior side of mechanical and electrical services within the plane of the insulation.
- E. Install with factory applied vapor retarder membrane facing warm side of building spaces. Lap ends and side flanges of membrane over framing members.
- F. Secure vapor barrier facing to framing along edges and at ends of batt at all applications. At horizontal applications additionally provide guy wire or netting to support insulation without sags.
- G. Batts: Attach by either method.
  - 1. Install as a single length between structural members or fold vapor barriers together and staple or tape at intermediate end joints.
  - 2. Staple or nail facing flanges in place at maximum 6 inches (150 mm) on center.
- H. Tape seal butt ends, lapped flanges, and tears or cuts in membrane.
- I. At wood framing, place vapor retarder on warm side of insulation by stapling at 6 inches (150 mm) on center. Lap and seal sheet retarder joints over member face.
- J. At metal framing, place vapor retarder on warm side of insulation; lap and seal sheet retarder joints over member face.
- K. Tape seal tears or cuts in vapor retarder.
- L. Extend vapor retarder tightly to full perimeter of adjacent window and door frames and other items interrupting the plane of the membrane. Tape seal in place.
- M. Acoustic Insulation: Place tightly within spaces, around cut openings, behind and around electrical and mechanical items within partitions, and tight to items passing through partitions.

#### **3.04 PROTECTION**

- A. Repair holes or tears with adhesive tape immediately before application of finish.
- B. Do not permit installed insulation to become wet or damaged prior to its concealment.

**END OF SECTION**

## SECTION 07 2216

### ROOF INSULATION

#### PART 1 GENERAL

##### 1.01 SECTION INCLUDES

- A. Roof insulation and installation.
  - 1. HCFC FREE "Green" Polyiso Rigid board type roof insulation(s) for thermal protection as part of roofing assemblies.

##### 1.02 RELATED SECTIONS

- A. Section 07 5550 - Modified Bitumen Roofing
- B. Section 07 6200 - Sheet Metal Flashing and Trim
- C. Sections specifying work related to or penetrating the roof.

##### 1.03 REFERENCES

- A. ASTM A-167-94a Specification for Stainless and Heat-Resisting Chromium Nickel Steel Plate, Sheet and Strip
- B. ASTM A- 653 Specification for Steel Sheet, Zinc-Coated (Galvanized) or Zinc - Iron Alloy-Coated (Galvanized) by the Hot-Dip Process
- C. ASTM B-29 Pig Lead
- D. ASTM B-32 Solder Metal
- E. ASTM C-165-95 Test Method for Measuring Compressive Properties of Thermal Insulation
- F. ASTM C-208-95 Specifications for Cellulosic Fiber Insulating Board
- G. ASTM C-209-92 Test Method for Cellulosic Fiber Insulating Board
- H. ASTM C-272-91 Test Method for Water Absorption of Core Materials for Structural Sandwich Constructions
- I. ASTM C 518 - Standard Test Method for Steady-State Heat Flux Measurements and Thermal Transmission Properties by Means of the Heat Flow Meter Apparatus.
- J. ASTM C-728-91 Specification for Perlite Thermal Insulation Board
- K. ASTM D-5 Test Method for Penetration of Bituminous Materials
- L. ASTM D-36 Test Method for Softening Point of Bitumen (Ring and Ball Apparatus)
- M. ASTM D-92 Test Method for Flash and Fire Pints by Cleveland Open Cup
- N. ASTM D-312 Specification for Asphalt Used in Roofing
- O. ASTM D-5147 Sampling and Testing Modified Bituminous Sheet Material
- P. ASTM E 84 - Standard Test Method for Surface Burning Characteristics of Building Materials.
- Q. ASTM E 96 - Standard Test Methods for Water Vapor Transmission of Materials.
- R. ASTM E 2114-01 - Standard Terminology for Sustainability Relative to the Performance of Buildings
- S. ASTM 2129 -01 - Standard Practice for Data Collection for Sustainability Assessment of Building Product

- T. FM Factory Mutual System, Norwood, Massachusetts
- U. NRCA National Roofing Contractors Association, Chicago, IL
- V. SMACNA Sheet Metal and Air Conditioning Contractors National Association
- W. UL Underwriter's Laboratories, Inc., Northbrook, Illinois
- X. FS HH-I-1972 Insulation Board, Polyisocyanurate
- Y. WH Warnock Hersey International, Inc. Middleton, WI

#### **1.04 DEFINITIONS**

- A. HCFC FREE "Green" Polyiso Roof Board Insulation is defined as environmentally friendly, with Zero Global Warming, Zero Ozone Depletion (ODP) as in compliance with the US EPA requirements of January 1, 2003 requirement to eliminate production of HCFC 141b.
- B. LTTR (Long Term Thermal Resistance) is defined as using techniques from ASTM C1303, CAN/ULC S770 predicting a foam's R-Value that has been shown to be equivalent to the average performance of a permeably faced foam insulation product over 15 years. In Canada this method is used as the Design R-Value. This applies to ALL foam insulation products with blowing agents other than air, such as Polyiso, "Green" Polyiso, extruded polystyrene and polyurethane. The new method is based on consensus standards in the US and Canada. PIMA has reported this method as providing a better understanding of the thermal performance of foam.

#### **1.05 SUBMITTALS**

- A. See Section 01 3300 - Submittals, for submittal procedures.
- B. Product Data: Manufacturer's specifications and installation instructions for each product specified.
- C. Provide approval letters from insulation manufacturer for use of their insulation within this particular roofing system type.
- D. Provide a sample of each insulation type.
- E. Shop Drawings:
- F. Indicate complete installation details of tapered insulation system, including identification of each insulation block, sequence of installation, layout, drain locations, roof slopes, thicknesses, crickets and saddles.
- G. Include: Outline of roof, location of drains and scuppers, complete board layout of tapered insulation components, thickness and the average "R" value for the completed insulation system.
- H. Certifications: Submit all of the following;
  - 1. Roof manufacturer's certification that insulation fasteners furnished are acceptable to roof manufacturer.
  - 2. Roof manufacturer's certification that insulation furnished is acceptable to roofing manufacturer as a component of roofing system and is eligible for roof manufacturer's system warranty.
  - 3. Wind uplift calculation, per CBC, Chapter 15, 1504 utilizing ASCE 7. Wind uplift shall be provided by the roofing system manufacturer. Calculation shall be signed and sealed by a CA licensed Structural II engineer.
  - 4. System Manufacturer's or insulation manufacturer's certification that HCFC FREE "Green" Polyiso materials meet Zero ODP (Ozone Depletion Potential) and Zero GWP (Global Warming Potential) specification requirements.

## **1.06 DESIGN REQUIREMENTS**

- A. No ponding of water on roof, all runoff flows to drain.
- B. All roof insulation overlaid with perlite board. No roofing installed over exposed insulation.

## **1.07 PERFORMANCE REQUIREMENTS**

- A. General: Fire Classification, ASTM E-108; Section specifies a roof system with an external fire rating. The descriptions given below are general descriptions. The insulation, recovery board, and all other components shall be included as required by the membrane manufacturer to provide a Factory Mutual Class 1A fire resistance rating or Listed by Underwriter's Laboratories or Warnock Hersey for external fire tests of ASTM - E - 108 Class A.
- B. Provide continuity of thermal barrier at building enclosure elements.
- C. Flame spread less than 25 when tested in accordance with ASTM E84.
- D. Smoke density less than 50 when tested in accordance with ASTM E84.

## **1.08 DELIVERY, STORAGE, AND HANDLING**

- A. Deliver materials in manufacturer's original, unopened packaging, with identifying tags or labels intact and legible.
- B. Coordinate scheduling for timely deliveries and prompt installation of materials.
- C. Store insulation and support system in a dry, protected area out of direct sunlight. If storage area is outdoors, store material off the ground and protected by a suitable waterproof cover.
- D. Remove insulation which is warped, broken or exposed from moisture from the site.

## **1.09 ENVIRONMENTAL REQUIREMENTS**

- A. Handle and install insulation system only under conditions and temperatures recommended by the manufacturer.
- B. Coordinate insulation placement to assure that material can be covered promptly with roof. Do not leave insulation exposed overnight or to inclement weather.

## **1.10 WARRANTY**

- A. Provide warranty coordinated with the requirements of other sections specifying roof products.

## **PART 2 PRODUCTS**

### **2.01 MANUFACTURER**

- A. Acceptable Manufacturers:
  - 1. Commercial Innovations, [www.commercialinnovations.com](http://www.commercialinnovations.com)
  - 2. Manville Roofing Systems, [www.jm.com](http://www.jm.com)
  - 3. Dow, [www.dow.com](http://www.dow.com)
  - 4. GAF, [www.gaf.com](http://www.gaf.com).
  - 5. U. S. Intec Inc., [www.usintec.com](http://www.usintec.com).
- B. Substitutions: See Section 01 6000 - Product Requirements.

### **2.02 MATERIALS**

- A. Polyisocyanurate Board or Tapered Roof Insulation: Provide thicknesses and slopes of insulation as indicated. Provide combination of types and thicknesses to provide a complete system.

1. Surface Burning Characteristics: Provide assembly with composite flame spread rating of 25 or less and smoke developed of 50 or less, as determined in accordance with ASTM E 84.
  2. Closed cell polyisocyanurate foam.
    - a. R-Value: Minimum 30.
  3. Insulation board shall meet the following requirements:
    - a. UL, WH or FM listed under Roofing Systems
    - b. Federal Specification HH-I-1972, Class 1
    - c. Dimensional Stability ASTM D2126 2% max.
    - d. Compressive Strength ASTM D1621 25 psi min.
    - e. Vapor Permeability ASTM E-96 1 perm max.
    - f. Foam Core Density ASTM D1622 2.0 pcf min.
    - g. Water Absorption ASTM C209 <1 %
    - h. Flame Spread ASTM E 84, 25 max.
    - i. R-Factor HR per inch thickness ASTM C 518 (Design Value)
- B. Related Materials:
1. Fiber Cant and Tapered Edge Strips: Performed rigid insulation units of sizes/shapes indicated or as required to achieve configurations shown, of perlite or organic fiberboard:
- C. Protection Board: preprimed gypsum board 1/2 inch thickness.
- D. Adhesive: Viking Products Group, Deckgrabber HR.
- E. Sprayed in place backfill insulation: Dow Great Stuff or as approved by roofing system manufacturer.
- F. Fasteners:
1. Corrosion resistant screw fastener as recommended by roof membrane manufacturer.
  2. Factory Mutual Tested and Approved with 3 in. coated disc for 1-90 rating, length required to penetrate deck one inch.

## **PART 3 EXECUTION**

### **3.01 EXAMINATION**

- A. Verify that roof framing system is complete and ready to receive insulation system. Do not proceed with installation until unsatisfactory conditions have been corrected.
1. Verify that work which penetrates roof deck has been completed.
  2. Verify that wood nailers are properly and securely installed.
  3. Examine surfaces for defects, rough spots, ridges, depressions, foreign material, moisture, and unevenness.
  4. Do not proceed until defects are corrected.
  5. Do not apply insulation until substrate is sufficiently dry, 12 percent moisture maximum, and ready to receive insulation and adhesive.
  6. Broom clean substrate immediately prior to application.
  7. Use additional insulation to fill depressions and low spots that would otherwise cause ponding water.

### **3.02 INSTALLATION**

- A. General: Install roof insulation in strict accordance with manufacturer's instructions and approved shop drawings.
- B. Roofing insulation attachment with mechanical fasteners:
1. Approved insulation board shall be fully attached to the deck with an approved mechanical fastening system. Attachment shall be per roofing system manufacturer's wind uplift calculation.

2. Place boards in a method to maximize contact bedding. Notch out undersides of insulation where insulation directly covers structural fasteners which are attached to the roof deck. Make notch equal to the length, width and depth of steel strap.
3. Filler pieces of insulation require at least two fasteners per piece if size of insulation is less than four square feet.
4. Provide spacing pattern of fasteners manufacturer's recommendations to meet wind uplift requirements. Placement of any fastener from edge of insulation board shall be a minimum of three inches, and a maximum of six inches.
5. Minimum penetration into deck shall be as recommended by the fastener manufacturer, and one inch (1") minimum for wood or metal decks where not specified by the manufacturer
6. Backfill around all conduit, junction boxes, etc. in roof insulation with spray foam insulation. Shave solidified spray foam even with board insulation surface.
7. Subsequent layers of insulation will be set in insulation adhesive. Stagger the joints of subsequent layers of polyisocyanurate and protection board over the initial layer.
8. Adhere cover board in foam insulation adhesive.

### **3.03 CLEANING AND PROTECTION**

- A. Remove debris and cartons from roof deck. Protect finished work to insure that insulation remains clean and dry, ready to receive roofing membrane.

**END OF SECTION**

**SECTION 07 2500  
WEATHER BARRIERS**

**PART 1 GENERAL**

**1.01 SECTION INCLUDES**

- A. Water-Resistive Barrier: Under exterior wall cladding, over sheathing or other substrate; not air tight or vapor retardant.
- B. Vapor Retarders: Materials to make exterior walls, joints between exterior walls and roof, joints around frames of openings in exterior walls, and under slabs-on-grade water vapor resistant and air tight.
- C. Air Barriers: Materials that form a system to stop passage of air through exterior walls, joints between exterior walls and roof, joints around frames of openings in exterior walls, and utility penetrations.

**1.02 RELATED REQUIREMENTS**

- A. Pertinent Sections specifying Volatile Organic Compound (VOC) Content Restrictions.
- B. Section 03 3000 - Cast-in-Place Concrete.
- C. Section 07 2100 - BOARD AND BATT BUILDING INSULATION: Vapor retarder installed in conjunction with batt insulation.

**1.03 DEFINITIONS**

- A. Weather Barrier: Assemblies that form either water-resistive barriers, air barriers, or vapor retarders.
- B. Air Barrier: Air tight barrier made of material that is relatively air impermeable but water vapor permeable, both to the degree specified, with sealed seams and with sealed joints to adjacent surfaces. Note: For the purposes of this specification, vapor impermeable air barriers are classified as vapor retarders.
- C. Vapor Retarder: Air tight barrier made of material that is relatively water vapor impermeable, to the degree specified, with sealed seams and with sealed joints to adjacent surfaces.
  - 1. Water Vapor Permeance: For purposes of conversion,  $57.2 \text{ ng}/(\text{Pa s sq m}) = 1 \text{ perm}$ .
- D. Water-Resistive Barrier: Water-shedding barrier made of material that is moisture resistant, to the degree specified, intended to be installed to shed water without sealed seams.

**1.04 REFERENCE STANDARDS**

- A. ASTM D1970/D1970M - Standard Specification for Self-Adhering Polymer Modified Bituminous Sheet Materials Used as Steep Roofing Underlayment for Ice Dam Protection; 2013.
- B. ASTM E84 - Standard Test Method for Surface Burning Characteristics of Building Materials; 2015a.
- C. ASTM E 154 - Standard Test Methods for Water Vapor Retarders Used in Contact with Earth Under Concrete Slabs, on Walls, or as Ground Cover
- D. Manufacturer's recommendations and specifications.
- E. ASTM D 1709 - Standard Test Methods for Impact Resistance of Plastic Film by the Free-Falling Dart Method

- F. ASTM E96/E96M - Standard Test Methods for Water Vapor Transmission of Materials; 2014.
- G. ASTM E1643 Selection, Design, Installation, and Inspection of Water Vapor Retarders Used in Contact with Earth or Granular Fill Under Concrete Slabs.
- H. ASTM E1745 - Standard Specification for Plastic Water Vapor Retarders Used in Contact with Soil or Granular Fill under Concrete Slabs; 2011.
- I. ASTM E2178 - Standard Test Method for Air Permeance of Building Materials; 2013.
- J. ICC-ES AC308 - Acceptance Criteria for Water-Resistive Barriers; ICC Evaluation Service, Inc; 2013.
- K. California Code of Regulations, Title 24, Part 2, California Building Code (CBC), International Building Code, with California Amendments.
- L. California Code of Regulations, Title 24, Part 11 California Green Building Standards Code, "CAL-Green".

#### 1.05 SUBMITTALS

- A. See Section 01 3300 - Submittals, for submittal procedures.
- B. Product Data: Provide data on material characteristics, performance criteria, and limitations.
- C. CAL-GREEN VOC Submittals: For adhesives sealants, fillers, coatings and primers, documentation including printed statement of VOC contents, comply with limits specified in related section.
- D. Below Grade Vapor Retarder Test Data: Submit independent third party test data for all listed performance values to show compliance with this specification. All test data for review shall be as published and released for publication by the authors without restriction of distribution.
  - 1. Summary of test results as described in ASTM E 1745.
    - a. Certify that all mandatory ASTM E1745 testing has been performed on a single production roll per ASTM E1745 Section 8.1. Test reports must specifically state that sampling and testing of materials are in strict accordance with the requirements of the standard.
  - 2. Manufacturer's samples and literature.
  - 3. Manufacturer's installation instructions for placement, seaming and penetration repair instructions.
- E. Shop Drawings: For air-barrier and weather-resistive barrier assemblies; provide drawings of special joint conditions.
  - 1. Show locations and extent of air barrier and weather-resistive barrier. Include details for substrate joints and cracks, counterflashing strips, penetrations, inside and outside corners, terminations, and tie-ins with adjoining construction.
  - 2. Include details of interfaces with other materials that form part of air barrier and weather-resistive barrier including related cladding, sealants and flashings.
  - 3. Provide project-specific details customized to this project's conditions. Manufacturer's standard details alone are not acceptable.
- F. Manufacturer's Installation Instructions: Indicate preparation, installation methods, and storage and handling criteria.
- G. Qualification Data: For Installer, Include list of ABAA-certified installers and supervisors employed by the Installer, who work on Project.



### 1.06 QUALITY ASSURANCE

- A. Installer Qualifications: An entity that employs installers and supervisors who are trained and approved by manufacturer.
  - 1. Installer shall be licensed by ABAA according to ABAA's Quality Assurance Program and shall employ ABAA-certified installers and supervisors on Project.
- B. Preinstallation Conference: Conduct conference at Project site after approval of complete submittal to comply with requirements in Division 1 Section "Project Management and Coordination." Review requirements for air barrier, including surface preparation specified under other Sections, substrate condition and pretreatment, temporary weather protection, forecasted weather conditions, special details and sheet flashings, installation procedures, testing and inspection procedures, and protection and repairs.
  - 1. Review air-barrier requirements and installation, special details, mockups, air-leakage and bond testing, air-barrier protection, and work scheduling that covers air barriers.

### 1.07 MOCK-UP

- A. Mockups: Build mockups to set quality standards for materials and execution and for preconstruction testing.
  - 1. Indicate portion of wall represented by mockup on Drawings or draw mockup as separate element.
  - 2. Build integrated mockups of exterior wall assembly 150 sq. ft. (14 sq. m), incorporating backup wall construction, external cladding, window, storefront, door frame and sill, insulation, ties and other penetrations, and flashing to demonstrate surface preparation, crack and joint treatment, application of air barriers, and sealing of gaps, terminations, and penetrations of air-barrier assembly.
    - a. Coordinate construction of mockups to permit inspection by Owner's testing agency of air barrier before external insulation and cladding are installed.
    - b. Include junction with roofing membrane, building corner condition, and foundation wall intersection.
    - c. If Architect determines mockups do not comply with requirements, reconstruct mockups and apply air barrier until mockups are approved.
    - d. Mock ups may be coordinated with mock ups required by other exterior material Sections, providing all provisions of this Section are met.
  - 3. Approval of mockups does not constitute approval of deviations from the Contract Documents contained in mockups unless Architect specifically approves such deviations in writing.

### 1.08 FIELD CONDITIONS

- A. Maintain temperature and humidity recommended by the materials manufacturers before, during and after installation.

## PART 2 PRODUCTS

### 2.01 PERFORMANCE REQUIREMENTS

- A. VOC Limits for adhesives sealants, fillers and primers. Comply with limits specified in Section 01 6116.
- B. General: The air barrier assembly shall be capable of performing as a continuous vapor-permeable air barrier and as a liquid-water drainage plane flashed to discharge to the exterior incidental condensation or water penetration. Air-barrier assemblies shall be capable of accommodating substrate movement and of sealing substrate expansion and control joints,

construction material changes, penetrations, tie-ins to adjacent waterproofing, and transitions at perimeter conditions without deterioration and air leakage exceeding specified limits.

- C. Air-Barrier Assembly Air Leakage: Less than 0.0008 cfm/sq. ft. of surface area at 1.57 lbf/sq. ft. (0.004 L/s x sq. m of surface area at 75 Pa), when tested according to ASTM E 2357.
- D. Building Envelope shall be constructed with a continuous air barrier to control air leakage into, or out of the conditioned space. An air barrier shall also be provided for interior partitions between conditioned space and space designed to maintain temperature or humidity levels which differ from those in the conditioned space by more than 50% of the difference between the conditioned space and design ambient conditions. The air barrier shall have the following characteristics:
  - 1. Continuous, with all joints made airtight.
  - 2. Capable of withstanding positive and negative combined design wind, fan and stack pressures on the envelope without damage or displacement, and shall transfer the load to the structure. It shall not displace adjacent materials under full load.
  - 3. Durable or maintainable.
  - 4. The air barrier shall be joined in an airtight and flexible manner to the air barrier material of adjacent systems, allowing for the relative movement of systems due to thermal and moisture variations and creep. Connection shall be made between:
    - a. Foundation and walls.
    - b. Walls and windows or doors.
    - c. Different wall construction and cladding assemblies.
    - d. Wall and roof.
    - e. Wall and roof over unconditioned space.
    - f. Walls, floor and roof across construction, control and expansion joints.
    - g. Walls, floors and roof to utility, pipe and duct penetrations.
  - 5. All penetrations of the air barrier and paths of air infiltration/exfiltration shall be made airtight.

## 2.02 WEATHER BARRIER ASSEMBLIES

- A. Water-Resistive Barrier: Provide on exterior walls under exterior cladding. Types specified in related sections specifying exterior cladding.
  - 1. Use building paper unless otherwise indicated.
  - 2. Under Portland cement stucco, use two separate layers of building paper.
  - 3. Under siding, use two separate layers of building paper.
- B. Air Barrier:
  - 1. On outside surface of sheathing of exterior walls use air barrier coating.

## 2.03 WATER-RESISTIVE BARRIER MATERIALS (NEITHER AIR BARRIER OR VAPOR RETARDER)

- A. Building Paper: Asphalt-saturated Kraft building paper complying with requirements of ICC-ES AC38 Grade D.
  - 1. Water Resistance, ASTM D779: > 60 minutes.
  - 2. Water Vapor Transmission, ASTM E96, 11 perms (MVT).
  - 3. Manufacturers:
    - a. Fortifiber Building Systems Group; Super JumboTex 60 min., ICC ESR-1027: [www.fortifiber.com](http://www.fortifiber.com).
    - b. Substitutions: See Section 01 6000 - Product Requirements.

## **2.04 AIR BARRIER MATERIALS (WATER VAPOR PERMEABLE AND WATER-RESISTIVE)**

- A. Air Barrier, Fluid Applied: Vapor permeable, elastomeric waterproofing.
- B. Air Barrier Coating: Fluid-applied, vapor permeable, elastomeric waterproofing membrane that creates a solid barrier against air infiltration and exfiltration, permits transfusion of water vapor that may condense in the wall structure, but is impermeable to liquid water.
  - 1. Material: Acrylic.
  - 2. Adhesion to Paper and Glass Mat Faced Sheathing: Sufficient to ensure failure due to delamination of sheathing.
  - 3. Dry Film Thickness (DFT): 10 mil, 0.010 inch (0.254 mm), minimum.
  - 4. Air Permeance: Less than 0.0008 cfm/sq. ft. of surface area at 1.57 lbf/sq. ft. (0.004 L/s x sq. m of surface area at 75 Pa), when tested according to ASTM E 2357.
  - 5. Air Permeance: 0.004 cfm/sq ft (0.02 L/(s sq m)), maximum, when tested in accordance with ASTM E2178.
  - 6. Water Vapor Permeance: 18 perms (1030 ng/(Pa s sq m)), minimum, when tested in accordance with ASTM E96/E96M Procedure B (Water Method) at 73.4 degrees F (23 degrees C).
  - 7. Ultraviolet (UV) and Weathering Resistance: Approved in writing by manufacturer for up to six months of weather exposure after application.
  - 8. Surface Burning Characteristics: Flame spread index of 25 or less, smoke developed index of 450 or less, when tested in accordance with ASTM E84.
  - 9. Nail Sealability: Pass, when tested in accordance with ASTM D1970/D1970M.
  - 10. VOC Content: 100 g per L or less.
  - 11. Sealants, Tapes and Accessories: As recommended by coating manufacturer.
  - 12. Manufacturers:
    - a. Dryvit Systems, Inc.; Backstop NT: [www.dryvit.com](http://www.dryvit.com).
  - 13. Substitutions: See Section 01 6000 - Product Requirements.
- C. Air Barrier Accessories:
  - 1. General: Accessory materials recommended by air-barrier manufacturer to produce a complete air-barrier assembly and compatible with primary air-barrier material. Provide accessory materials by the same manufacturer as the primary air-barrier.
  - 2. Termination Mastic: Air-barrier manufacturer's standard cold fluid-applied elastomeric liquid for details and terminations, trowel grade.
    - a. W.R Grace & Co.; Bituthene® Liquid Membrane: [www.graceconstruction.com](http://www.graceconstruction.com).
    - b. Equivalent Products by Dryvit and Henry.
    - c. Substitutions: Section 01 6000.
  - 3. Termination Sealant: Air-barrier manufacturer's alternate product for details and terminations, one-part neutral curing, ultra low modulus silicone sealant.
    - a. W.R Grace & Co.; Basis of Design: S100 Sealant: [www.graceconstruction.com](http://www.graceconstruction.com).
    - b. Equivalent Products by Dryvit and Henry.
    - c. Substitutions: Section 01 6000.
  - 4. Transition Strips: Self-adhering elastomeric flashing strips comprised of rubberized asphalt backed by a layer of cross-laminated, high-density polyethylene. Membrane shall be interleaved with disposable plastic release liner until installed.
    - a. Dryvit Systems, Inc.; Aqua-Flash Detail Membrane: [www.dryvit.com](http://www.dryvit.com).
    - b. Henry Co, Inc.; Blueskin: [www.henry.com](http://www.henry.com).
    - c. W.R Grace & Co.; Perm-A-Barrier® Detail Membrane: [www.graceconstruction.com](http://www.graceconstruction.com)
    - d. Substitutions: Section 01 6000.

5. Through Wall Flashing: Self-adhering elastomeric flashing tape comprised of rubberized asphalt backed by a layer of cross-laminated, high-density polyethylene. Membrane shall be interleaved with disposable plastic release liner until installed.
  - a. W.R Grace & Co.; Perm-A-Barrier® Wall Flashing: [www.graceconstruction.com](http://www.graceconstruction.com)
  - b. Equivalent Products by Dryvit and Henry.
  - c. Substitutions: Section 01 6000.
6. Joint Sealant: ASTM C 920, single-component, neutral-curing silicone; Class 100/50 (low modulus), Grade NS, Use NT related to exposure, and, as applicable to joint substrates indicated, Use O. Comply with Section 07 9005 "Joint Sealers."

## 2.05 VAPOR RETARDER MATERIALS (AIR BARRIER AND WATER-RESISTIVE)

- A. Under-Slab Vapor Retarder/Barrier Sheet: 15 mil, single ply extruded polyolefin, ASTM E 1745, performance classification A, B, and C;
  1. Water vapor permeance, ASTM E 154 or E 96 procedure B: 0.009 perm maximum.
  2. Tensile strength ASTM D 882 or ASTM E154, sec. 9; 45 lb/in.
  3. 0.01 or less perm vapor performance per ASTM E 154 Section 8, 11, 12 and 13; 0.0054 WVTR water vapor permeance per ASTM F 1249;
  4. Minimum puncture resistance, ASTM D 1709, Method B: 2200 grams.
  5. Products:
    - a. Epro Waterproofing Systems; ECOSHIELD-E15, 15-mil thick Sheet Membrane Vapor Retarder: [www.eproserv.com](http://www.eproserv.com).
    - b. Stego Industries, LLC, San Diego, CA; Stego Wrap Vapor Barrier, 15 mils: [www.stegoindustries.com](http://www.stegoindustries.com).
    - c. W.R Meadows, PERMINATOR, 15-mil thick, [www.meadows.com](http://www.meadows.com).
    - d. REEF Industries, Inc., Griffolyn® Reinforced Vapor Protection, VAPORGUARD®, [www.reefindustries.com](http://www.reefindustries.com).
    - e. Substitutions: See Section 01 6000 - Product Requirements.
- B. Adhesives, sealants and plastic cement: Types recommended by manufacturer to suit application and for compliance with referenced standards.
- C. Sealing Tape: Two-sided tape; 4 inch wide black seaming tape with release liner, perm rating not less than vapor retarder, complying with ASTM E 1643 - Standard Practice for Installation of Water Vapor Retarders Used in Contact with Earth or Granular Fill under Concrete Slabs; types recommended by manufacturer to suit application.
- D. Detail Tape and/or patch membrane for Concrete Adhesion:
  1. Type recommended by manufacturer tape and/or membrane detail strip and/or membrane to mechanically lock vapor retarder to concrete.
  2. Permeance: Comply with ASTM F1249.
  3. Peel Adhesion: Comply with PSTC 101
  4. Tensile Strength: Comply with ASTM E 154, Sec. 9
  5. Puncture Resistance: Comply with ASTM D 1709
  6. Product: Stego; Crete Claw Tape; [www.stego.com](http://www.stego.com).
- E. Vapor Retarder Stakes:
  1. Product: Vaporstake, LLC; Polyvinyl Black VaporStake™: [www.vaporstake.com](http://www.vaporstake.com).
    - a. Solid Plastic construction: ASTM E1643-11 (sec. 8.4 & 8.6) and ACI 302.2R-06
    - b. Use with Vapor Retarders: ASTM E 1745-09
    - c. Recycled content: 100%
    - d. Size: Length for application and diameter recommended by manufacturer for application.

## 2.06 SEALANTS

- A. Single-Component, Nonsag, Neutral-Curing Silicone Joint Sealant: ASTM C 920, Type S, Grade NS, Class 100/50, for Use NT, complying with requirements of related Section 07 9005. Type as recommended by wall finish manufacturer for conditions indicated, and as required to maintain single-source warranty continuity.
  - 1. Color: As selected by Architect from manufacturer's standards.

## 2.07 ACCESSORIES

- A. Flexible Flashing: Self-adhesive sheet flashing complying with ASTM D1970/D1970M, except slip resistance requirement is waived if not installed on a roof.
  - 1. Products: By same manufacturer as air barrier coating, as recommended by manufacturer for specific application.
    - a. Dryvit Systems, Inc.; Aqua-Flash Detail Membrane: [www.dryvit.com](http://www.dryvit.com).
    - b. Grace Construction Products; Perma-Barrier Detail Membrane, Perma-Barrier Wall Flashing: [www.grace.com](http://www.grace.com).
    - c. Substitutions: See Section 01 6000 - Product Requirements.
- B. Thinners and Cleaners: As recommended by material manufacturer, meeting VOC requirements specified.
- C. Primers, Cleaners, and Other Sealant Materials: As recommended by sealant manufacturer, appropriate to application, and compatible with adjacent materials, meeting VOC requirements specified.
- D. Pre-molded Opening Corners: Size as required for snug fit at opening corners, resilient material compatible with related flexible flashings and air barriers, as recommended and manufactured by sheet material manufacturer.
  - 1. Grace Construction Products; "VYCORners" (pre-molded corners): [www.na.graceconstruction.com](http://www.na.graceconstruction.com),

## PART 3 EXECUTION

### 3.01 EXAMINATION

- A. Verify that surfaces and conditions are ready to accept the work of this section.

### 3.02 PREPARATION

- A. Remove projections, protruding fasteners, and loose or foreign matter that might interfere with proper installation.
- B. Clean and prime substrate surfaces to receive sealants and fluid-applied membranes and self-adhered flashings in accordance with manufacturer's instructions.

### 3.03 INSTALLATION

- A. Install materials in accordance with manufacturer's instructions.
- B. Water-Resistive Barriers: Install continuous barrier over surfaces indicated, with sheets lapped to shed water but with seams not sealed.
- C. Air Barriers: Install continuous air tight barrier over surfaces indicated, with sealed seams and with sealed joints to adjacent surfaces.
- D. Vapor Retarders: Install continuous air tight barrier over surfaces indicated, with sealed seams and with sealed joints to adjacent surfaces.

- E. Apply sealants and adhesives within recommended application temperature ranges. Consult manufacturer if temperature is out of this range.
- F. Building Paper and Flashings for surfaces receiving Plaster Cladding or strip or panel siding:
  - 1. Cover surfaces of sheathed framed wall assembly with 2 layers of building paper, without holes, tears, or gaps. Apply building paper using single separate layer method. Secure end laps at supports.
  - 2. Attach to framed construction with fasteners extending through sheathing into framing. Space fasteners at 12 to 18 inches on center along each framing member supporting sheathing.
  - 3. Sequence work to ensure installation of papers continuously behind applied accessories.
  - 4. Lap horizontal edges 4-inches minimum, shingle fashion to weather.
  - 5. Lap vertical edges 6-inches minimum and seal with tape.
  - 6. Install water-resistive barrier over jamb flashings.
  - 7. Install air barrier and vapor retarder UNDER jamb flashings.
  - 8. Install head flashings under weather barrier.
  - 9. At openings to be filled with frames having nailing flanges, wrap excess sheet into opening; at head, seal sheet over flange and flashing.
  - 10. Double bottom layer at corners, extending 6-inches around corner from each side.
  - 11. Lap sheet metal and flexible flashings. Lap felt flashing strips at door frames and windows; lap over head and jamb strips and under sill strip.
  - 12. Coordinate installation with related section to ensure that no part of metal lath specified in related sections extends under paper or flashing. Weather all laps to exterior.
- G. Flexible Flashing: Install in at opening flashings, at locations indicated and underlying horizontal and sloped areas of plaster cladding, in inset wall opening sills and similar locations; in accordance with the manufacturer's recommendations and as follows:
  - 1. Substrate Preparation:
    - a. Smooth, clean, dry and free of voids, spalled areas, loose substrate, loose nails, sharp protrusions or other matter that will hinder the adhesion or regularity of installation.
    - b. Clean loose dust or dirt by wiping with a clean dry cloth or brush. Prime substrate with compatible primer in conditions recommended by flashing manufacturer.
  - 2. Flashing Application:
    - a. Coordinate installation with other paper and metal flashings, interleave as required to weather all laps to drain, directing water to exterior.
    - b. Coordinate installation with window and insert opening frames.
    - c. Peel release paper from roll to expose adhesive surface and position flashing to center over joint location before application. Ensure flashing is centered over joint opening. Avoid fishmouths.
    - d. Press flashing firmly into place and hand-roll with resilient roller. Ensure full, continuous and intimate contact with the substrate. Cut out wrinkles or other affected areas and replace with smooth flat membrane.
    - e. Flashing shall be continuously supported by the substrate without spanning or bridging joints, gaps or voids in excess of 1/4 inch. Minimum End Laps 2 inch.
  - 3. Leave flexible flashing in condition to receive installation of metal lath at locations to receive plaster cladding.
  - 4. Preformed Resilient Corners: Provide at all lower corner openings of windows unless metal sill pan flashings are shown on the drawings.
- H. Coatings:
  - 1. Prepare substrate in manner recommended by coating manufacturer; treat joints in substrate and between dissimilar materials as recommended by manufacturer.

2. Use flashing to seal to adjacent construction and to bridge joints.
- I. Openings and Penetrations in Exterior Weather Barriers:
1. Install flashing over sills, covering entire sill frame member, extending at least 5 inches (125 mm) onto weather barrier and at least 6 inches (150 mm) up jambs; mechanically fasten stretched edges.
  2. Lap sheets shingle-fashion to shed water and seal laps air tight.
  3. Once sheets are in place, press firmly into substrate with resilient hand roller; ensure that all laps are firmly adhered with no gaps or fishmouths.
  4. At openings to be filled with frames having nailing flanges, seal head and jamb flanges using a continuous bead of sealant compressed by flange and cover flanges with sealing tape at least 4 inches (100 mm) wide; do not seal sill flange.
  5. At openings to be filled with non-flanged frames, seal weather barrier to each side of opening framing, using flashing at least 9 inches (230 mm) wide, covering entire depth of framing.
  6. At head of openings, install flashing under weather barrier extending at least 2 inches (50 mm) beyond face of jambs; seal weather barrier to flashing.
  7. At interior face of openings, seal gap between window/door frame and rough framing, using joint sealant over backer rod.
  8. Service and Other Penetrations: Form flashing around penetrating item and seal to weather barrier surface.

#### 3.04 INSTALLATION- VAPOR RETARDER UNDER CONCRETE SLAB-ON-GRADE

- A. Install materials in accordance with manufacturer's instructions and ASTM E 1643-98.
1. Unroll Vapor Retarder membrane with the longest dimension parallel with the direction of the concrete pour.
  2. Extend vapor barrier over footings and grade beams to a distance acceptable to the structural engineer or stop at impediments such as dowels and waterstops.
  3. Seal vapor barrier to footing/grade beam with double sided tape, termination bar, or both.
  4. Lay-out sheets to minimize quantity of joints.
    - a. Lap edge 6 -inches minimum and end joints 12 -inches minimum and continuously seal with joint tape.
  5. Apply tape to a clean and dry vapor retarder membrane.
  6. Terminate vapor retarder membrane per manufacturer's recommendations along perimeter; at footers, vertical walls, and against penetrations.
    - a. Seal perimeter with continuous mastic bead along foundation walls.
    - b. Seal barrier joints with tape.
- B. No penetration of the Vapor Retarder membrane is allowed except for reinforcing steel and permanent utilities.
1. Seal all penetrations (including pipes) with field-assembled boots per manufacturer's instructions.
  2. Where forms are used, provide Vapor Stakes to hold forms in place.
    - a. Penetrate vapor Retarder with stake.
    - b. Treat stake as pipe penetration.
    - c. Leave stake permanently in concrete.
    - d. Using a power saw, cut the stake off above the seal, but below the concrete finished surface not higher than elevation of horizontal reinforcing.
    - e. The lower portion of the vapor stake remains in place, permanently plugging the penetration.

- C. Refer to Section 03 3000 "Cast-in-Place Concrete" for installation coordination requirements.
- D. Repair damaged areas by cutting patches of Vapor Barrier/Retarder, overlapping damaged area 6 -inches and taping all four sides with tape.
  - 1. Do not use concrete adhesion tape to repair penetrations.
- E. Where differential settlement is possible, adhere the vapor retarder at building perimeter and in a grid pattern every 4 -feet on-center with integrally bonded detail tape for concrete adhesion.

**3.05 PROTECTION**

- A. Protect under-slab vapor retarder sheets from puncture during installation. Patch punctures before proceeding with subsequent construction.
  - 1. NOTE: SCREEDING STAKES DRIVEN THROUGH RETARDER must be repaired per membrane manufacturer's recommendation.
- B. Install runway planks in construction traffic lanes until slabs are poured.

**3.06 FIELD QUALITY CONTROL**

- A. See Section 01 4000 - Quality Requirements, for additional requirements.
- B. Do not cover installed weather barriers until required inspections have been completed.
- C. Obtain approval of installation procedures by the weather barrier manufacturer based on a mock-up installed in place, prior to proceeding with remainder of installation.
- D. Under-slab Vapor Retarder Membrane: Conduct a visual inspection, in the presence of the Architect/Engineer, of the entire Retarder installation the day before pouring concrete. Make all necessary corrections prior to placing concrete.
- E. Take digital photographs of each portion of the installation prior to covering up.

**3.07 PROTECTION**

- A. Do not leave materials exposed to weather longer than recommended by manufacturer.
- B. Do not leave paper- or felt-based barriers exposed to weather for longer than one week.

**END OF SECTION**



## SECTION 07 2633

### WATER VAPOR EMISSION CONTROL COATING

#### PART 1 GENERAL

##### 1.01 SUMMARY

- A. Epoxy type, environmentally safe, 100 percent solids, water vapor emission and alkalinity control coating. A Moisture Mitigation and Alkalinity Control System as defined in ASTM F3010.
- B. Cementitious leveling underlayment applied over moisture mitigation coating as required by specific flooring adhesive to be used at each finish flooring condition.
  - 1. Coordinate all flooring manufacturers adhesive requirements for submitted flooring materials in each area to determine requirements for flooring adhesive underlayments.

##### 1.02 RELATED REQUIREMENTS

- A. Section 01 4000 "Quality Control" for product manufacturer's independent laboratory qualifications.
- B. Section 01 6116 "VOC Restrictions".
- C. Section 03 3000 "Cast-in-Place Concrete" for Concrete slab substrate.
- D. Division 09 Section specifying concrete floor surface preparation.
- E. Division 09 Section specifying floor moisture and pH testing.
- F. Division 09 Floor Covering Sections, for installation requirements and to verify compatibility with the floor covering manufacturer's adhesives.

##### 1.03 REFERENCED STANDARDS

- A. California Code of Regulations, Title 24, Part 2, California Building Code (CBC), International Building Code, with California Amendments.
- B. California Code of Regulations, Title 24, Part 11 California Green Building Standards Code, "CAL-Green".
- C. American Concrete Institute:
  - 1. ACI 318 - Building Code Requirements for Structural Concrete.
- D. ASTM International:
  - 1. ASTM C109 - Standard Test Method for Compressive Strength of Hydraulic Cement Mortars (Using 2-in. Cube Specimens).
  - 2. ASTM D1308 - Standard Test Method for Effort of Household Chemicals on Clear and Pigmented Organic Finishes.
  - 3. ASTM D1653-03(2008) Standard Test Methods for Water Vapor Transmission of Organic Coating Films
  - 4. ASTM D7234-12 - Standard Test Method for Pull-Off Adhesion Strength of Coatings on Concrete Using Portable Pull-Off Adhesion Testers
  - 5. ASTM E96 - Standard Test Methods for Water Vapor Transmission of Materials.
  - 6. ASTM E1155 Standard Test Method for Determining FF Floor Flatness and FI Floor Levelness Numbers
  - 7. ASTM F2170-09 Standard Test Method for Determining Relative Humidity in Concrete Floor Slabs Using in situ Probes.

8. ASTM F3010 - 13 Two-Component Resin Based Membrane-Forming Moisture Mitigation Systems for Use Under Resilient Floor Coverings.
- E. International Concrete Repair Institute (ICRI) Guideline No. 03732- Selecting and Specifying Concrete; Surface Preparation for Sealers, Coatings and Polymer Overlays.
- F. EPA Method 24 VOC Content Testing.

#### **1.04 DEFINITIONS**

- A. Water Vapor Emission Control Coating (Moisture Mitigation Control System): A sequence of products applied on a concrete floor to isolate moisture and high pH in the concrete from adhesive and finish floor covering.
- B. Water Vapor Emission Control Barrier: Coating applied on concrete floor that acts as the primary barrier to moisture movement.
- C. Underlayment: Trowelable or pourable cementitious patching/leveling compounds to which the finish floor covering is adhered. Underlayment is installed on top of the Water Vapor Emission Control Barrier.

#### **1.05 SUBMITTALS**

- A. General: Submit in accordance with Section 01 3300.
- B. Provide complete submittals at the same time as submittals for work in related sections to permit review of complete and integrated systems and assemblies.
- C. Product Data: For each type of product indicated, demonstrate compliance with specified attributes.
  1. Include detailed installation requirements, spread rates, joint and crack treatment and final barrier surfaces for floor coverings.
  2. ASTM Reports: Certified laboratory reports for specified ASTM performance.
  3. Extended Warranty Certificate: Manufacturers standard 15 year warranty for manufacturing defects and on site material performance. Warranty shall not list ACI-318 compliance exclusions.
  4. Pail Labels: Collect and submit each original pail label of Water Vapor Emission Control Coating installed. Copies are not acceptable. If pail labels are not removable, provide pails.
- D. Quality Control Post-Testing: Tensile pull-off testing results per ASTM D7234 performed by Owner's Testing Agency prior to floor covering installation.
- E. CAL-GREEN Submittals: Product Data – VOC Limits: For adhesives sealants, fillers, primers and coatings, documentation including printed statement of VOC contents, comply with limits specified in related section.
- F. Shop Drawings: Floor Plans, indicating areas of installation, sequencing, and total area of installation in square feet.
- G. Manufacturer Certification: Provide letterhead documentation of complete review of concrete mix designs, admixtures, sub-slab vapor retarder installation and curing methods with written acceptance prior to installation.
- H. Installer Proof of Qualification: Factory licensed, approved or certified applicator certificate signed by the manufacturer.

## 1.06 QUALITY ASSURANCE

- A. **Manufacturer Qualifications:** Manufacturer shall have not less than five years experience in manufacturing floor moisture mitigation systems. The products shall be specifically formulated and marketed to reduce concrete floor moisture vapor interaction with resilient floor coverings and for pH control.
- B. **Installer Qualifications:** Installer shall have not less than five years experience installing the selected fluid based coating systems, shall be trained by the manufacturer, experienced in surface preparation and application of the material and shall be subject to inspection and control by the manufacturer.
- C. **Pre-installation Testing:**
  - 1. Document floor and building conditions are within acceptable limits of temperature, relative humidity, and concrete condition before proceeding with product application.
  - 2. File a pre-installation checklist with the manufacturer and receive written confirmation of approval to proceed to support manufacturer's 10-year warranty.
- D. **Product Performance:**
  - 1. Manufacturer shall provide independent laboratory test reports documenting the following:
    - a. Water vapor transmission by ASTM E96 (water method) or ASTM D1653 indicating a maximum 0.1 perms net for coating on concrete.
    - b. Warrant no loss in moisture-resistance properties for a period of ten years of exposure to continuous water contact and pH greater than 10 after final cure.
- E. **Mock-Up:** Provide a mock-up for evaluation of surface preparation techniques and moisture mitigation system application workmanship.
  - 1. Mockup area of at least 200 sq ft in location approved by Architect / Owner.
  - 2. Do not proceed with work until mockup workmanship and underlayment surface appearance are approved by manufacturer's representative and Owner's representative.
  - 3. Mockup bond tests: Owner's Testing Agency will perform tensile bond tests in triplicate on mockup, no sooner than 72 hours after installation is completed, according to ASTM D7234 through entire Water Vapor Emission Control Coating into concrete substrate. Comply with the following:
    - a. No cohesive failure of leveling underlayment with at least 200 psi, or tensile failure in concrete substrate with no inter-layer or intra-layer failure of Water Vapor Emission Control Coating.
    - b. If failure occurs, determine cause and method(s) to avoid further unacceptable work. Remove and re-apply mock-up area as required to produce acceptable work. Do not proceed with installation of Water Vapor Emission Control Coating until bond test results meet requirements above and are acceptable to Water Vapor Emission Control Coating manufacturer.

## 1.07 DELIVERY, STORAGE, AND HANDLING

- A. Deliver products to the job site in their original unopened containers, clearly labeled with the manufacturer's name and brand designation.
- B. Store products in an approved ventilated dry area; protect from dampness, freezing, and direct sun light. Do not store in areas with temperatures in excess of manufacturer's written instructions.

- C. Handle product in a manner that will prevent breakage or leakage of containers and damage to products.
- D. Use products before manufacturer's expiration dates.

#### **1.08 PROJECT CONDITIONS**

- A. Maintain environmental conditions (temperature, humidity, and ventilation) within limits required by moisture mitigation system manufacturer. Do not install products under environmental conditions outside manufacturer's limits.
- B. Do not apply Water Vapor Emission Control Coating to unprotected surfaces or when moisture is present on the surface of the concrete.
- C. Do not apply Water Vapor Emission Control Coating when air or floor temperature is lower than 50 degrees F (10 degrees C) or expected to fall below this temperature within 24 hours from time of application.
- D. Install Water Vapor Emission Control Coating only when concrete floor surface temperature is a least 5 degrees Fahrenheit above the dewpoint temperature of the air over the floor. Maintain and document coated floor surface temperature at least 5 degrees Fahrenheit above air dewpoint temperature for at least 24 hours after application.
- E. Provide continuous ventilation and air movement at all times during application and curing process of the moisture mitigation system.
- F. Protect work to prevent damage that will affect performance and the finished underlayment surface.

#### **1.09 WARRANTY**

- A. Extended Warranty: Warranty shall provide, at Owner's option, repair or replacement of the Water Vapor Emission Control Coating and flooring damaged due to failure of the Water Vapor Emission Control Coating during the warranty period. Warranty definition of damage shall include at least the following:
  - 1. Distress of flooring caused by moisture including but not limited to
    - a. Adhesive deterioration resulting in loss of flooring bond to the floor;
    - b. Formation of bubbles, mole trails, lumps, bumps, seam separation, or other significant displacement that interferes with the intended use of the flooring;
  - 2. Distress of the Water Vapor Emission Control Coating including but not limited to
    - a. Deformation of patching/leveling compounds installed under the Water Vapor Emission Control Coating;
    - b. Adhesive or cohesive failure of Water Vapor Emission Control Coating components;
    - c. Distress of underlayment above the Water Vapor Emission Control Coating such as delamination, disbanding, expansion, chemical reaction, or other deformation or displacement that interferes with the intended use of the flooring.
- B. Water Vapor Emission Control Coating Warranty coverage shall commence on the date of completion of flooring installation.
- C. Warranty shall include the replacement of Water Vapor Emission Control Coating, flooring system, patching compounds, installation accessories flooring materials and labor costs.
  - 1. Warranty shall not exclude or become void due to non-conformance to ACI-318 parameters, dew-point, concrete salts, admixtures, resin and silicate surface treatments or cohesive substrate failure in the concrete surface due to normal concrete movement.

Installation of Water Vapor Emission Control Coating indicates acceptance of site conditions.

## **PART 2 PRODUCTS**

### **2.01 SYSTEM DESCRIPTION**

- A. Comply with product requirements of ASTM F3010: Non-corrosive, low viscosity, high gloss, microbial resistant, moisture-alkaline resistant coating to suppress, control and mechanically restrict water emission and pH level of concrete substrates for compliance with subsequent floor coverings or coating materials.
- B. Coating product must contain 100% epoxy resin solids. Products based on silicate chemistry, potassium, sodium, lithium, and similar formulations, water-based acrylics, or resin formulations containing or mixed with water, are not acceptable and will be rejected.
- C. Barrier Coating Requirements: It is the intent of this section and the drawings to require a complete barrier system. Any items not specifically noted but necessary for a complete barrier system shall be provided under this section.
  - 1. Coating shall be compatible with all types of floor covering products, no system failures due to improper installations and contain no water/alkaline soluble compounds.
  - 2. Coating shall have a sufficient density to reduce water vapor transmission, avoid water vapor damage to other adhered systems and resistant to most commonly encountered acids/solvents in case of topical exposure (spills).
  - 3. Coating shall be resistant to mold, mildew and biological growth when applied to prepared substrates

### **2.02 PERFORMANCE REQUIREMENTS**

- A. Moisture and Alkalinity: Barrier shall remain tolerant to alkalinity of 14 pH per ASTM D1308 and to 100% relative humidity per ASTM F2170.
- B. Water Vapor Transmission:
  - 1. Manufacturer shall provide independent laboratory test reports documenting the following:
    - a. Water vapor transmission by ASTM E96 (water method) or ASTM D1653 indicating a maximum 0.1 perms net for coating on concrete.
    - b. Warrant no loss in moisture-resistance properties for a period of fifteen years of exposure to continuous water contact and pH greater than 8 after final cure.

### **2.03 WATER VAPOR EMISSION CONTROL COATING**

- A. Source Limitations: Provide materials approved by one Water Vapor Emission Control Coating manufacturer including moisture-resistant concrete patching and leveling compounds for use under Water Vapor Emission Control Coating, primers, coatings, sand, and underlayment leveling/patching compounds.
- B. Basis of Design: VAP I 2000 Zero VOC family of products by Koster Waterproofing Systems. Subject to compliance with requirements specified in this section, provide one of the following products:
  - 1. VAP I 2000 Zero VOC family of products by Koster Waterproofing Systems, [www.kosterusa.com](http://www.kosterusa.com).
    - a. VAP I 2000 Zero VOC, twelve hour cure time to final flooring.
    - b. VAP I 2000 FS (Fast Set); four hour cure time to final flooring.
    - c. VAP I 2000 UFS (Ultra Fast Set); two hour cure time to final flooring.

2. A C Tech ® 2170 FC ZERO System: by Allied Construction Technologies, Inc.  
www.actamerican.net, www.combimix.com..
  3. VaporTight SG3 by Aquafin, www.aquafin.net.
  4. MC™ RAPID by Ardex, www.ardexamericas.com.
  5. Substitutions: See Section 01 6000.
- C. Single Coat System: 2-component, VOC Compliant, 100% solids epoxy formulated as a vapor barrier against high moisture and alkalinity in concrete substrates. Apply at manufacturer's recommended rate, minimum average 15-mils (0.015-in.), to provide maximum 0.1 net perms (grains/hr/sq ft/in. Hg) water vapor transmission.
1. Floor preparation in compliance with coating manufacturers written requirements and meeting warranty criteria.
  2. Manufacturer's approved bonding agent/primer
  3. Moisture Mitigation System Control Coating: Apply a single coat at manufacturer's recommended and tested coverage rate, minimum average to provide maximum 0.1 net perms (grains/hr/sq ft/per 1-inch Hg) water vapor transmission.
  4. Cementitious Leveling Underlayment: Manufacturer's approved.
- D. Water Vapor Emission Control Coating: Epoxy resins and other chemical compounds; 100 % solids, specifically formulated chemicals and resins to provide the following properties. Coating product must contain 100% epoxy resin solids.
1. Solid Content: 100%.
  2. VOC, mixed: 0 g/L.
  3. Flash Point: 200° F.
  4. Perm Rating, ASTM E96: Not to exceed 0.1 grains/ sq.ft. /hour in Hg.
  5. ASTM E 96, Water Vapor Transmission (wet methods) Performance shall be documented by an independent testing laboratory at a minimum 97% for water vapor transmission reduction compared to untreated concrete.
  6. ASTM D 1308; Insensitivity to alkaline environment up to, and including, pH 14 in a 14 day bath test.
  7. Certify acceptance and exposure to continuous topical water exposure after final cure.
  8. System must be able to perform as required with ASTM F2170 RH Probe readings of 100%.
- E. Expansion Joint Treatment: By Coating manufacturer or approved by coating manufacturer and type recommended to suit site conditions.
1. Basis of Design for KOSTER system: KOSTER Joint Sealant FS-H.
- F. Non-Moving Crack Treatment: By Coating manufacturer or approved by coating manufacturer and type recommended to suit conditions indicated.
1. Basis of Design for KOSTER system: KOSTER TA mixed with KOSTER VAP I 2000.
- G. Self-Leveling Primer: By Coating manufacturer or approved by coating manufacturer and type recommended to suit site conditions.
1. Basis of Design for KOSTER system: KOSTER VAP I® 06 Primer.
  2. Application: Applied over Moisture Mitigation System Coating Control System coating prior to installation of Underlayment.
- H. Patching / Leveling Compounds: Formulated primarily of calcium aluminate or portland hydraulic cements, minimum compressive strength 3,000 psi at 28 days when tested in accordance with ASTM C109. Patching / Leveling compounds that rely primarily on gypsum for their cementing properties shall not be used.
1. By Coating manufacturer or approved by coating manufacturer and type recommended to suit site conditions.

2. Basis of Design for KOSTER system: KOSTER SL, Cementitious Underlayment.
- I. Surface treatment for concrete contaminated with Soluble Silicates: By Coating manufacturer or approved by coating manufacturer and type recommended to suit conditions indicated.
  1. Basis of Design for KOSTER system: KOSTER IB.
  2. Application: Apply to contaminated concrete prior to Moisture Mitigation System Coating Control System Sealer application.

### **PART 3 EXECUTION**

#### **3.01 EXAMINATION**

- A. Site Verification: Verify substrate conditions are acceptable for a warranted system.
- B. Verify new concrete floors have cured minimum 28 days.
- C. Verify concrete cleaned by shot blasting or other mechanical abrasion as specified in related section to an ICRI CSP-3 to CSP-4 profile and is not excessively rough for sealing at specified moisture mitigation coating application rates.
  1. Verify removal of dirt, oils, films, and other materials detrimental to sealer application.
- D. Examine substrates, with Installer present, for compliance with requirements for surface contamination, damage, and other conditions affecting performance of the Work.
- E. Examine substrate to determine repairs required to restore substrate surface to be within tolerances required for floor finishes specified in other sections, prior to completing Work of this section.
- F. Examine substrate to verify surfaces prepared in accordance with this section will be suitable for application of finishes specified in other sections.
- G. Prepare written report, endorsed by Installer, listing conditions detrimental to performance with recommendations for methods and materials required to correct conditions before proceeding with work of this section.
- H. Proceed with surface preparation only after unsatisfactory conditions have been corrected.
  1. Proceeding with surface preparations indicates acceptance and of surfaces and conditions of substrate.
- I. Verify items which penetrate concrete substrate to receive coating are securely installed and coating installation will not affect proper installation and warranty requirements.
- J. Surfaces shall be free of water, rain, snow and frost.

#### **3.02 PREINSTALLATION TESTING**

- A. Moisture and pH Testing: As specified in related Section 09 0512.
- B. Verify relative humidity testing in accordance with ASTM F2170 and alkalinity-pH testing is completed using methods specified and acceptable results obtained.

#### **3.03 PREPARATION**

- A. Surface Preparation: As specified in related Section 09 0511.
- B. Protection: Mask and protect walls, equipment from adjacent work and finishes during installation process.
- C. Concrete Fiber Reinforcement, if present after shot blasting, shall be burned off, scraped and vacuumed, leaving no fibers protruding from the concrete surface.

- D. Cleaning: Broom-sweep and vacuum slab surfaces to remove contaminants.
- E. Do not acid etch surface. Do not apply water to surface.
- F. Joints and Cracks: Fill cracks, construction joints, sawcut control joints, and surface irregularities with crack repair compound.
  - 1. Route cracks with 4 to 6-inch diameter x 0.060-inch diamond abrasive wheel to not more than 1-1/8 to 1-1/4-inch depth. Clean by vacuum to remove dust and residue.
  - 2. Mix and apply crack repair compound according to manufacturer's instructions using gravity feed.
  - 3. Fill cracks to within 1/8-inch. of surface, add sand and apply additional crack repair compound to saturate sand and slightly overfill crack.
  - 4. Scrape or lightly grind flush after curing to provide a level surface for Water Vapor Emission Control Coating.
  - 5. Fill cracks completely to stabilize against concrete movement and to provide moisture barrier.

### 3.04 INSTALLATION

- A. Apply Water Vapor Emission Control Coating where relative humidity and alkalinity tests do not meet flooring manufacturers requirements for floor finishes:
- B. Apply Water Vapor Emission Control Coating based on relative humidity and alkalinity test results in strict compliance with the manufacturer's written instructions.
- C. Water Vapor Emission Control Coating System Application:
  - 1. Coverage rates are dependent on the surface texture and porosity of the substrate.
  - 2. Apply sufficient coating to achieve the manufacturer's recommended minimum film thickness using manufacturer's recommended squeegee or roller. Periodically check application rate and wet film thickness. Follow manufacturer's recommended curing times.
  - 3. Two-coat system: Apply sand broadcast to rejection into second coat according to manufacturer's written instructions. After curing, remove excess sand by sweeping and vacuuming.
- D. Cementitious Underlayment System:
  - 1. Self-Leveling Cementitious Underlayment:
    - a. One-coat Water Vapor Emission Control Coating without sand broadcast, apply primer to coating. Do not exceed manufacturer's recommended application rate and film thickness. Thicker primer can lead to cracking of underlayment. Allow manufacturer's specified cure time. Do not exceed manufacturer's specified open time. Mix and pour the underlayment product on the floor and disperse with the approved spreader, followed by smoothing the material with the approved smoother. Wear cleated shoes to avoid leaving marks.
    - b. Do not exceed maximum application thickness specified by underlayment manufacturer. Provide a smooth, uninterrupted, level finish without bumps, clumps, depressions, or other defects that would reflect through flooring.
    - c. Floor finish shall be flat to within 1/8-inch. in 10 ft, and as measured by ASTM E1155. Provide Ff of 50 and Fl of 30.
  - 2. Inspect and Repair defects:
    - a. Inspect hardened underlayment for flatness.
    - b. Lightly sand flat any bumps in the underlayment. Unhydrated or partially hydrated clumps of underlayment cement shall be removed by carefully chiseling and patching



with compatible trowel-applied patching compound recommended by underlayment manufacturer. Do not penetrate the moisture mitigation coating.

- c. Fill low spots with compatible trowel-applied patching compound recommended by underlayment manufacturer. Sand smooth to remove trowel marks.
- E. Allow surfaces to cure and re-apply additional coats as required to form a uniform control layer.

### **3.05 FIELD QUALITY CONTROL**

- A. Manufacturer and installer to guarantee installed Water Vapor Emission Control Coating is compatible with all specified floor coverings.
- B. Post-Installation Testing: Owner's Testing Agency to perform the following testing:
  - 1. Tensile bond tests: Perform tensile bond tests in triplicate, at the same rate as Relative Humidity testing specified in related section, no sooner than 72 hours after installation is completed, according to ASTM D7234 through entire Water Vapor Emission Control Coating into concrete substrate. Comply with the following:
    - a. No cohesive failure of leveling underlayment with at least 200 psi, or tensile failure in concrete substrate with no inter-layer or intra-layer failure of Water Vapor Emission Control Coating.
  - 2. Repair failed test locations at no cost to Owner and re-test to demonstrate compliance.

### **3.06 PROTECTION**

- A. Protect each coat from damage due to traffic, topical water and contaminants during required cure period until acceptance by related floor covering section.

**END OF SECTION**

**SECTION 07 4113  
METAL ROOF PANELS**

**PART 1 GENERAL**

**1.01 SECTION INCLUDES**

- A. Architectural roofing system of preformed steel panels.
- B. Attachment system.
- C. Accessories and miscellaneous components: Flashings, fasteners, and accessories as required for weatherproof installation.

**1.02 RELATED REQUIREMENTS**

- A. Pertinent Sections specifying Volatile Organic Compound (VOC) Content Restrictions.
- B. Section 06 1000 - Rough Carpentry: Roof sheathing.
- C. Section 07 4150 - Metal Wall Panels: Preformed wall panels.

**1.03 REFERENCE STANDARDS**

- A. ASTM A792/A792M - Standard Specification for Steel Sheet, 55% Aluminum-Zinc Alloy-Coated by the Hot-Dip Process; 2010 (Reapproved 2015).
- B. ASTM D1970/D1970M - Standard Specification for Self-Adhering Polymer Modified Bituminous Sheet Materials Used as Steep Roofing Underlayment for Ice Dam Protection; 2013.
- C. ASTM E96/E96M - Standard Test Methods for Water Vapor Transmission of Materials; 2014.
- D. ASTM E1646 - Standard Test Method for Water Penetration of Exterior Metal Roof Panel Systems by Uniform Static Air Pressure Difference; 1995 (Reapproved 2011).
- E. ASTM E1680 - Standard Test Method for Rate of Air Leakage Through Exterior Metal Roof Panel Systems; 2011.
- F. California Code of Regulations, Title 24, Part 2, California Building Code (CBC), International Building Code
- G. California Code of Regulations, Title 24, Part 11 California Green Building Standards Code, "CAL-Green".
- H. Sheet Metal and Air Conditioning Contractors National Association: "Architectural Sheet Metal Manual".
- I. UL 580 - Standard for Tests for Uplift Resistance of Roof Assemblies; Current Edition, Including All Revisions.

**1.04 SUBMITTALS**

- A. General: Submit in accordance with Section 01 3300.
- B. Product Data: For each type of product indicated, demonstrate compliance with specified attributes. Manufacturer's data sheets on each product to be used, including:
  - 1. Summary of test results, indicating compliance with specified requirements.
  - 2. Storage and handling requirements and recommendations.
  - 3. Installation methods.
  - 4. Specimen warranty.
- C. CAL-GREEN Submittals: Product Data.

1. VOC Limits: For adhesives sealants, fillers, primers and coatings, documentation including printed statement of VOC contents, comply with limits specified in related section.
  2. Product Test Reports: For roof materials, indicating that roof materials comply with Solar Reflectance Index requirement and demonstrate Cool Roof Rating Council (CRRC) listing.
- D. Shop Drawings: Include layouts of roof panels, details of edge and penetration conditions, spacing and type of connections, flashings, underlayments, details of trim, gutter, ridge, curved panel and flashing conditions, fastening and anchorage methods, weatherproofing techniques, terminations, and flashing of each type of penetrations, and special conditions.
1. Show work to be field-fabricated or field-assembled.
  2. Include structural analysis signed and sealed by qualified structural engineer, indicating compliance of roofing system to specified loading conditions.
  3. Indicate metal thickness and finishes, panel lengths, joining details, anchorage details, flashings and special fabrication provisions for termination and penetrations; purlin and girt locations, thermal expansion provisions and special supports.
  4. Include roof plan showing clip spacing at ridge, eave and field.
  5. Indicate relationships with adjacent and interfacing work. Demonstrate continuity of air barriers with related wall assemblies and roof underlayment.
  6. Shop drawings must be completed by the metal roof panel manufacturer's engineering department.
  7. All changes recommended by Contractor must be approved by the manufacturer in writing prior to submittal.
- E. Selection Samples: For each roofing system specified, submit color chips representing manufacturer's full range of available colors and patterns.
- F. Verification Samples: For each roofing system specified, submit samples of minimum size 12 inches (305 mm) square, representing actual roofing metal, thickness, profile, color, and texture.
1. Include typical panel joint in sample.
  2. Include typical fastening detail.
- G. Warranty: Submit specified manufacturer's warranty and ensure that forms have been completed in Owner's name and are registered with manufacturer.

#### **1.05 INFORMATIONAL SUBMITTALS**

- A. Delegated-Design Submittal: For metal roofs indicated to comply with performance requirements and design criteria, substantiating system performance, structural capacity, anchorages and fasteners sizes and spacings per specified criteria, including analysis data signed and sealed by the qualified professional engineer responsible for their preparation.
1. Detail fabrication and anchorage of metal roofs.
  2. Include design calculations.
  3. Provide clip fastener pull-out test report and calculations.
- B. Qualification Data: For qualified Installer and testing agency.
- C. Professional Engineer Qualifications: Demonstrate compliance with specified requirements.
- D. Preconstruction Test Reports: For sealant.
- E. Product Test Reports: Based on evaluation of comprehensive tests performed by a qualified testing agency, indicating compliance with performance requirements. For each system provide test reports with shop drawings.
- F. Design test reports:
1. Indicate fastener types and spacings; and provide fastener pullout values.

2. Submit copy of manufacturer's minimum design load calculations according to ASCE 7.
  3. Submit test results meeting or exceeding values specified in the Performance Criteria Article of this specification and stamped by an independent Testing Agency.
- G. Certificates:
1. Manufacturer's Certificate that all products conform to specified requirements.
  2. Manufacturer's Representative Certificate that installation conforms to specified requirements.
- H. Quality-control reports.
1. Field quality-control reports.
- I. Warranties: Sample of special warranties.

#### **1.06 SCHEDULING AND SEQUENCING**

- A. Include in construction schedule:
1. When field measurement for factory production will be taken.
  2. Order and delivery time.
  3. Installation period.
- B. Determine that work of other trades will not hamper or conflict with necessary fabrication and storage requirements for preformed metal roofing system.
- C. Schedule field measurements far enough in advance, to permit fabrication of panels to required lengths without delay to the construction schedule.
- D. Sequence installation to avoid other activities over metal roofing.
- E. Do not cover underside of metal roofed areas until water intrusion test has been performed.

#### **1.07 QUALITY ASSURANCE**

- A. Manufacturer Qualifications: Company specializing in manufacturing products specified in this section, with not less than five years of documented experience.
- B. Installer Qualifications: Company specializing in the type of work specified, with not less than five (5) years of documented experience; trained and authorized by roofing system manufacturer with written certification from manufacturer.
1. Maintain a full-time supervisor/foreman with minimum of five (5) years experience with the installation of system similar to that specified on the job-site at all times during installation of new roof system.
  2. Upon Owner request, fabricator/installer shall submit work experience and evidence of adequate financial responsibility. The owner's representative reserves the right to inspect fabrication facilities in determining qualifications.
- C. Delegated Design: Design metal roof assembly components and anchorages under direct supervision of a Professional Structural Engineer experienced in design of this Work and licensed at the State in which the Project is located.
- D. Professional Engineer Qualifications: A professional engineer who is legally qualified to practice in jurisdiction where Project is located and who is experienced in providing engineering services of the kind indicated. Engineering services are defined as those performed for installations of assemblies that are similar to those indicated for this Project in material, design, and extent.
- E. Engineering Responsibility: Prepare design for metal roof systems, including Shop Drawings, based on testing and engineering analysis of manufacturer's standard units in systems similar to those indicated for this Project.

- F. Manufacturer's Testing Agency Qualifications: Qualified according to ASTM E 699 for testing indicated.
- G. Product Options: Information on Drawings and in Specifications establishes requirements for systems' aesthetic effects and performance characteristics. Aesthetic effects are indicated by dimensions, arrangements, alignment, and profiles of components and assemblies as they relate to sightlines, to one another, and to adjoining construction. Performance characteristics are indicated by criteria subject to verification by one or more methods including preconstruction testing, field testing, and in-service performance.
  - 1. Do not revise intended aesthetic effects, as judged solely by Architect, except with Architect's approval. If revisions are proposed, submit comprehensive explanatory data to Architect for review.

#### **1.08 DELIVERY, STORAGE, AND HANDLING**

- A. Provide strippable plastic protection on prefinished roofing panels for removal after installation.
- B. Store roofing panels on project site as recommended by manufacturer to prevent damage to panels prior to installation.
- C. Order materials based on field measurements, not on construction drawings.
- D. Deliver, store, protect and handle products to site under provisions of Section 01 6000 - Product Requirements.
- E. Coordinate delivery schedule with installation schedule. Do not deliver materials of this section to project site until suitable facilities for storage and protection are available.
- F. Protect materials from damage during transit and at project site. Store under cover, off ground, sloped to provide positive drainage, protected from wind, foreign material contamination, mechanical damage, cement, lime or other corrosive substances. Do not expose materials with strippable protective film to direct sunlight or extreme heat.
  - 1. Store preformed and prefinished material to prevent twisting, bending, or abrasion, and to provide ventilation. Slope metal sheets to ensure drainage.
  - 2. Provide protective interleaving between contact areas of exposed surfaces to prevent abrasion during shipment, storage, and handling.
  - 3. Prevent contact with materials which may cause discoloration or staining
- G. Inspect materials upon delivery. Reject and remove physically damaged or marred material from project site.
- H. Do not allow storage of other materials or allow staging of other work on installed metal panel roof system.
  - 1. Do not overload roof with stored materials.
  - 2. Do not support roof mounted equipment directly on roofing system.

#### **1.09 WARRANTY**

- A. See Section 01 7800 - Closeout Submittals, for additional warranty requirements.
- B. Finish Warranty: Provide manufacturer's special warranty covering failure of factory-applied exterior finish on metal roof panels and agreeing to repair or replace panels that show evidence of finish degradation, including significant fading, chalking, cracking, or peeling within specified warranty period of five years from Date of Substantial Completion.
- C. Waterproofing Warranty: Provide manufacturer's warranty for weathertightness of roofing system, including agreement to repair or replace roofing that fails to keep out water within specified warranty period of five years from Date of Substantial Completion.

## **PART 2 PRODUCTS**

### **2.01 DESIGN REQUIREMENTS**

- A. Roof Panel System: Provide roof system with performance as specified when installed, designed in accordance with applicable codes.
  - 1. Make weathertight.
  - 2. Make free from objectionable warp, wave and buckle.
- B. Provide structural performance appropriate to substrate over which roof system is installed.
- C. Design and size components to withstand loads caused by wind pressures as specified in applicable code.
- D. Capacities for gauge, span or loading other than those tested may be determined by interpolation of test results within the range of test data. Extrapolation for conditions outside test range are not acceptable.
- E. Drainage: Provide positive drainage to exterior for moisture entering building enclosure or condensation occurring within exterior building envelope.

### **2.02 MANUFACTURERS**

- A. Obtain all components of roof system from a single manufacturer including roll good materials if required to comply with metal roof manufacturer warranty. Secondary products required which cannot be supplied by the specified metal roof manufacturer must be those recommended and approved in writing by the specified metal roof manufacturer.
- B. Acceptable manufacturers and products are:
  - 1. The Garland Company, Inc.: [www.garlandco.com](http://www.garlandco.com).
- C. Substitutions: See Section 01 6000 - Product Requirements.
  - 1. Requests for substitution of proposed alternate systems must meet or exceed all performance requirements listed in Performance Criteria, Warranty and Quality Assurance Articles.
  - 2. Submit complete product and test data for each proposed substitution.

### **2.03 ARCHITECTURAL METAL ROOF PANELS**

- A. Architectural Metal Roofing: Provide complete engineered system complying with specified requirements and capable of remaining weathertight while withstanding anticipated movement of substrate and thermally induced movement of roofing system.
- B. Performance Criteria:
  - 1. Wind Uplift: Class 90 wind uplift resistance of UL 580.
  - 2. Air Infiltration: Maximum 0.06 cfm/sq ft (1.1 cubic meters/hr/sq m) at air pressure differential of 6.24 lbf/sq ft (300 Pa), when tested according to ASTM E1680.
  - 3. Water Penetration: No water penetration when tested according to procedures and recommended test pressures of ASTM E1646. Perform test immediately following air infiltration test.
  - 4. Thermal Movement: Design system to accommodate without deformation, leaks, or stress to supporting structure anticipated thermal movement over ambient temperature range of 120 degrees F (67 degrees C).
    - a. Interface between panel and clip shall provide for unlimited thermal-induced movement in each direction along the longitudinal direction of the roof panel.
    - b. Locate panel fixed connection at roof ridge unless otherwise required by project conditions and approved by specified manufacturer's designer.
- C. Metal Panels: Factory-formed panels with factory-applied finish.
  - 1. Steel Panels:

- a. Aluminum-zinc alloy-coated steel complying with ASTM A792/A792M; minimum AZ50 (AZM150) coating.
- b. Steel Thickness: Minimum 24 gage (0.024 inch) (0.61 mm).
2. Profile: Standing seam, with minimum \_\_\_ inch (2-3/8 mm) minimum seam height; concealed fastener system for field seaming with special tool.
  - a. Symmetrical profile permitting removal of individual panels without removing adjacent panels.
3. Texture: Smooth.
4. Length: Full length of roof slope, without lapped horizontal joints.
5. Width: Maximum panel coverage of 24 inches (610 mm).

#### **2.04 ATTACHMENT SYSTEM**

- A. Concealed System: Provide manufacturer's standard stainless steel or nylon-coated aluminum concealed anchor clips designed for specific roofing system and engineered to meet performance requirements, including anticipated thermal movement.
  1. Concealed Anchor Clips: G-90 galvanized steel, 16 gauge, 40,000 psi yield ONE (1) piece clip with projecting legs.
    - a. Clip design: Isolate sealant in panel cap from contact with clip to limit sealant damage during expansion and contraction.
    - b. Configured to maintain minimum clearance of 3/8 inch between panel and substrate for ventilation to reduce condensation and reduce contact of panel fastener head to panel.
  2. Snap-on Seam cap: Minimum 1 inch wide "T" shaped of continuous length matching roof panel, field seamed by manufacturer's seaming machine.
    - a. Cap designed to receive continuous double bead of sealant and avoid contact with anchor clip, allowing unlimited thermal movement of panel without damage to cap sealant.
- B. Fasteners: As recommended by manufacturer for project conditions and panel type, concealed wherever possible.
  1. Concealed fasteners: Corrosion resistant steel screws designed to meet structural loading requirements. The normal minimum screw size shall be Rawl #14.
  2. Exposed fasteners: Corrosion resistant steel screws (cadmium or zinc coatings are not acceptable), stainless steel with neoprene sealing washer, or 3/16 inch diameter waterproof rivets with color matched finish.

#### **2.05 FINISHES**

- A. Energy Performance: Provide roofing system with initial Solar Reflectance not less than 0.70 when tested according to ASTM D 1549 and Thermal Emittance not less than 0.75 when tested according to ASTM D 1371 and listed on Cool Roof Rating Council's CRRC-1.
  1. Energy Performance: ENERGY STAR and Cool Roof Rating Council (CRRC) rated.
- B. Fluoropolymer Coating System: Polyvinylidene fluoride (PVDF) multi-coat thermoplastic fluoropolymer coating system, including minimum 70 percent PVDF fluoropolymer color topcoat with minimum total dry film thickness of 0.9 mil (0.023 mm); color and gloss to match sample.
- C. Concealed Surface Finish: Baked-on polyester coating with 0.20-0.30 mil DFT.
- D. Exposed Finish Color(s) as indicated on drawings.

#### **2.06 ACCESSORIES**

- A. Miscellaneous Sheet Metal Items: Provide flashings, gutters, downspouts, trim, moldings, closure strips, preformed crickets, caps, and equipment curbs of the same material, thickness,

and finish as used for the roofing panels. Items completely concealed after installation may optionally be made of stainless steel.

- B. Rib and Ridge Closures: Provide prefabricated, close-fitting components of steel with corrosion resistant finish or combination steel and closed-cell foam.
- C. Sealants: Types specified in related section with the following characteristics, except concealed seam sealant.
  - 1. Exposed Sealant: Elastomeric; silicone, polyurethane, or silyl-terminated polyether/polyurethane.
  - 2. Concealed sealant must be non-hardening, butyl type.
  - 3. Seam Sealant: Non-skinning, non-drying type recommended and factory-applied by roof panel manufacturer.
  - 4. Exposed sealant colors as selected by Architect, compatible with roof finish color.
- D. Underlayment: Self-adhering rubber-modified asphalt sheet complying with ASTM D1970/D1970M; 22 mil (0.55 mm) total thickness; with strippable release film and woven polypropylene sheet top surface.
  - 1. Sheet Thickness: 22 mil, 0.022 inch (0.55 mm) minimum total thickness.
  - 2. Self Sealability: Passing nail sealability test specified in ASTM D1970/D1970M.
  - 3. Low Temperature Flexibility: Passing test specified in ASTM D1970/D1970M.
  - 4. High Temperature Resistance formulation.
  - 5. Water Vapor Permeance: 0.1 perm (5.72 ng/Pa s sq m), maximum, when tested in accordance with ASTM E96/E96M Procedure A (desiccant method).
  - 6. Manufacturers:
    - a. Grace Construction Products; Ultra: [www.graceconstruction.com](http://www.graceconstruction.com).
    - b. Henry Company; Blueskin PE200HT: [www.henry.com/#sle](http://www.henry.com/#sle).
    - c. Substitutions: See Section 01 6000 - Product Requirements.
- E. Provide all miscellaneous accessories for complete installation.

## 2.07 FABRICATION

- A. Form metal work true to required shape, accurate in size and radius, square and free from distortion or defects, with clear, sharp, straight, and uniform bends and rises. Hem exposed edges of flashings. Fabricate to predetermined exact lengths wherever possible. Cut panels to precise lengths indicated from field measurements.
- B. Machine roll roof and flashing elements required to be curved or radiused. Do not field bend or "walk-down". Provide true curves, segmented fabrication not allowed.
- C. Panels: Fabricate panels and accessory items at factory to the greatest extent possible, using manufacturer's standard processes as required to achieve specified appearance and performance requirements.
- D. Joints: Factory-install captive gaskets, sealants, or separator strips at panel joints to provide weathertight seals, eliminate metal-to-metal contact, and minimize noise from panel movements.
- E. Accessories: Factory-fabricate trim and flashing components in longest practical lengths.
  - 1. Provide mitered corners, joined using closed end pop rivets and joint sealant.
- F. Roof-related Flashings: Provide as specified in related sections, as required by roofing material manufacturers and referenced standards. Coordinate work of this section with related sections. Provide complete systems without conflict or omission.
  - 1. Fabricate roofing and related sheet metal work in accord with approved shop drawings and applicable standards.



### **PART 3 EXECUTION**

#### **3.01 EXAMINATION**

- A. Do not begin installation of preformed metal roof panels until substrates have been properly prepared.
  - 1. Determine if work of other trades which penetrates the roof or is to be made watertight by the roof is in place and approved prior to installation of roofing.
  - 2. Verify pipes, sleeves, or vents through roof are solidly set, reglets are in place, and nailing strips located.
    - a. Locate penetrations in the center of roofing panel.
  - 3. Verify roofing termination, base flashings and gutter flanges are in place, sealed, and secure.
  - 4. Notify Architect in writing if substrates are not suitable for application of panel system.
  - 5. Do not proceed with installation until substrates are acceptable.
- B. Structural surfaces: Smooth, even, sound, surface dry 19 percent maximum, clean and free of depressions, waves, or projections before material is applied.
  - 1. Examine the alignment and placement of the building structure and substrate. Correct any objectionable warp, waves or buckles in the substrate before proceeding with installation of the preformed metal roofing. The installed roof panels will follow the contour of the structure and may appear irregular if not corrected.
- C. Apply no materials during wet weather or on wet surface.

#### **3.02 INTERFACE WITH OTHER WORK**

- A. Coordinate with roof accessories, miscellaneous sheet metal accessories, piping vents and other items specified in related sections penetrating metal roofing work. Avoid conflict or omission in waterproofing systems and provide watertight installation.

#### **3.03 PREPARATION**

- A. Verify field dimensions prior to ordering materials.
  - 1. Establish straight side and crosswise benchmarks.
  - 2. Check rectangular roofs for squareness and straightness. Gable ends may not be straight; set a true line for the gable clips and flashing with stringline.
  - 3. Measure the roof lengthwise to confirm panel lengths, overhangs, coverage of flashings at eaves and ridges and verify clearances for thermal movement.
- B. Broom clean wood sheathing prior to installation of roofing system.
- C. Coordinate roofing work with provisions for roof drainage, flashing, trim, penetrations, and other adjoining work to assure that the completed roof will be free of leaks.
- D. Coordinate installation of waterproof membrane over roof sheathing with 06 1000.
- E. Remove protective film from surface of roof panels immediately prior to installation. Strip film carefully, to avoid damage to prefinished surfaces.
- F. Separate dissimilar metals by applying a bituminous coating, self-adhering rubberized asphalt sheet, or other permanent method approved by roof panel manufacturer.
- G. Where metal will be in contact with wood or other absorbent material subject to wetting, seal joints with sealing compound and apply one coat of heavy-bodied bituminous paint.

#### **3.04 INSTALLATION**

- A. Overall: Install roofing system in accordance with approved shop drawings and panel manufacturer's instructions and recommendations, as applicable to specific project

conditions. Anchor all components of roofing system securely in place while allowing for thermal and structural movement.

1. Install roofing system with concealed clips and fasteners, except as otherwise recommended by manufacturer for specific circumstances. Where exposed fasteners are unavoidable, use fasteners prefinished to match panels.
  2. Minimize field cutting of panels. Where field cutting is absolutely required, use methods that will not distort panel profiles. Use of torches for field cutting is absolutely prohibited.
- B. Accessories: Install all components required for a complete roofing assembly, including flashings, gutters, downspouts, trim, moldings, closure strips, preformed crickets, caps, equipment curbs, rib closures, ridge closures, and similar roof accessory items.
1. Install surface mounted reglets true to lines and levels. Seal top of reglets with sealant.
- C. Flashings: Coordinate to provide weathertight conditions at roof terminations. Fabricate and install in accordance with standards of SMACNA Manual.
1. Install flashings as shown on Drawings and approved shop drawings.
  2. Secure flashings in place using concealed fasteners.
  3. Cleat and seam all joints.
  4. Apply plastic cement compound between metal flashings and felt flashings.
  5. Fit flashings tight in place. Make corners square, surfaces true and straight in planes, and lines accurate to profiles and radius indicated or required.
  6. Seal metal joints watertight with two parallel beads of sealant, do not permit sealant to migrate to exposed surfaces.
  7. Overlap roof panels at least 6 inches.
  8. Install flashings to allow thermal movement.
- D. Install self-adhering underlayment on roof deck before installing preformed metal roof panels. Secure by methods acceptable to roof panel manufacturer, minimizing use of metal fasteners. Apply from eaves to ridge in shingle fashion, overlapping horizontal joints a minimum of \_\_ inches (4 mm) and side and end laps a minimum of \_\_ inches (6 mm). Offset seams in successive layers of underlayment..
1. Cover entire surface under panels; holes or tears not permitted.
  2. Lap sheet metal flashings. All laps shall weather to exterior.
  3. Double layer at changes in plane by extending 6 inches around corner from each side.
  4. Install a 3'-0" wide additional layer of self-adhering undrlayment at flashing and panel terminations (ridges, eaves, rakes, and roof penetrations).
- E. Roof Panels: Install panels in strict accordance with manufacturer's instructions, minimizing transverse joints except at junction with penetrations. Install panels plumb, level, and true to line.
1. Form weathertight standing seams incorporating concealed clips, using an automatic mechanical seaming device approved by the panel manufacturer.
  2. Fully interlock panels with adjacent panels; apply sealants as recommended by panel manufacturer to achieve weathertight installation.
  3. Provide sealant tape or other approved continuous joint sealer at lapped panel joints.
  4. Install sealant or sealant tape, as recommended by panel manufacturer, at end laps and side joints.
  5. Cut panels only at approved locations, and only where necessary to make openings for penetrations and field adjustments. Cut using a power saw with metal cutting blade.
    - a. Back paint concealed metal surfaces with protective backing paint to a minimum dry film thickness of 0.45 mil.
  6. Isolate dissimilar metals and masonry or concrete from metals with bituminous coating. Provide gasketed stainless steel fasteners between dissimilar metals.

7. Provide for temperature expansion/contraction movement of panels at roof penetrations and roof mounted equipment in accordance with panel manufacturer's product data and design calculations.
- F. Anchorage shall allow for temperature expansion/contraction movement without stress or elongation of panels, clips, or anchors. Attach clips to structural substrate using fasteners of size, length and spacing as determined by manufacturer's design analysis to resist imposed loads.
  1. Provide fastener head size beneath roof panel as recommended by panel manufacturer.
  2. Limit exposed fasteners to extent indicated on shop drawings.
- G. Do not allow shavings, metal dust, or chips to fall on panels.
  1. Capture all drilling debris with a rag or cloth placed on the panels at the drilling operation.
- H. Provide installed roof that is true to line and plane, free of dents, and physical defects with a minimum of oil canning.

### **3.05 CONSTRUCTION TOLERANCES**

- A. Maximum Alignment Variation: 1/4 inch in 20 feet, 3/8" in 40'-0" or more.

### **3.06 FIELD QUALITY CONTROL**

- A. Testing:
  1. Re-test until roof is shown to be watertight.
- B. Manufacturer Field Services: Provide daily site inspection for a minimum of one (1) hour during active roofing operations by an experienced, full time employee of the roofing manufacturer. Submit written reports as specified.

### **3.07 CLEANING**

- A. Clean exposed sheet metal work at completion of installation. Remove grease and oil films, excess joint sealer, handling marks, and debris from installation, leaving the work clean and unmarked, free from dents, creases, waves, scratch marks, or other damage to the finish.
- B. Touch up minor abrasions and exposed fasteners with matching paint provided by panel manufacturer. Remove and replace panels that cannot be satisfactorily touched up.
  1. No exposed sealant or visible raw metal.
- C. Sweep and remove chips, shavings, and dust from roof on a daily basis during installation period. Leave installed work clean, free from grease, finger marks and stains.
- D. Upon completion of installation, remove scraps and debris from project site.

### **3.08 PROTECTION**

- A. Do not permit storage of materials or roof traffic on installed roof panels. Provide temporary walkways or planks as necessary to avoid damage to completed work. Protect roofing until completion of project.
- B. Touch-up, repair, or replace damaged roof panels or accessories before Date of Substantial Completion.

**END OF SECTION**

## SECTION 07 4150

### METAL WALL PANELS

#### PART 1 - GENERAL

##### 1.01 SUMMARY

- A. Related Documents:
  - 1. Drawings and general provisions of the Contract, including General and Supplementary Conditions and Division 1 Specification Sections apply to this Section.
- B. Section Includes:
  - 1. Prefinished panels over site screen framing including flashings, closures, and accessories.
- C. Related Sections:

##### 1.02 DEFINITIONS

- A. Metal Wall Panel Assembly: Metal wall panels, attachment system components, miscellaneous metal framing, and accessories necessary for a complete roofing system.

##### 1.03 PERFORMANCE REQUIREMENTS

- A. General Performance: Metal wall panels shall comply with performance requirements without failure due to defective manufacture, fabrication, installation, or other defects in construction.
- B. Wind-Uplift Resistance: Provide metal wall panel assemblies that comply with wind-uplift-resistance class indicated.
  - 1. Uplift Rating: Verify panel meets uplift requires using ASCE 7.
- C. Structural Performance: Provide metal wall panel assemblies capable of withstanding the effects of loads and stresses within limits and under conditions indicated, based on testing according to ASTM E 1592:
  - 1. Wind Loads: Determine loads based on the following minimum design wind pressures per ASCE 7.
- D. Thermal Movements: Allow for thermal movements resulting from ambient and surface temperature changes. Base calculations on surface temperatures of materials due to both solar heat gain and nighttime-sky heat loss.
  - 1. Temperature Change (Range): 120 deg F, ambient; 180 deg F, material surfaces.

##### 1.04 REFERENCES

- A. ASTM - American Society for Testing and Materials:
  - 1. ASTM A 653-04a: Specification for Steel Sheet, Zinc-Coated (Galvanized) or Zinc-Iron Alloy-Coated (Galvannealed) by the Hot-Dip Process

2. ASTM A 755-03: Specification for Steel Sheet, Metallic Coated by the Hot-Dip Process and Prepainted by the Coil-Coating Process for Exterior Exposed Building Products
  3. ASTM A 792-05: Specification for Steel Sheet, 55% Aluminum-Zinc Alloy-Coated by the Hot-Dip Process
  4. ASTM C 518-04: Test Method for Steady-State Thermal Transmission Properties by Means of the Heat Flow Meter Apparatus
  5. ASTM C 920-05: Specification for Elastomeric Joint Sealants
  6. ASTM D 2244-02: Test Method for Calculation of Color Differences from Instrumentally Measured Color Coordinates
  7. ASTM D 4214-98: Test Methods for Evaluating Degree of Chalking of Exterior Paint Films
  8. ASTM E 84-05: Test Method for Surface Burning Characteristics of Building Materials
  9. ASTM E 96-00: Test Methods for Water Vapor Transmission of Materials
  10. ASTM E 108-04: Test Methods for Fire Tests of Wall Coverings
  11. ASTM E 119-00a: Test Methods for Fire Tests of Building Construction and Materials
  12. ASTM E 136-04: Test Method for Behavior of Materials in a Vertical Tube Furnace at 750 Deg C
  13. ASTM E 329-05: Specification for Agencies Engaged in the Testing and/or Inspection of Materials Used in Construction
  14. ASTM E 408-71: (Reapproved 2002) Test Methods for Total Normal Emittance of Surfaces Using Inspection-Meter Techniques
  15. ASTM E 903-96: Test Method for Solar Absorptance, Reflectance, and Transmittance of Materials Using Integrating Spheres
  16. ASTM E 1514-98: (Reapproved 2003): Specification for Structural Standing Seam Steel Wall Panel Systems
  17. ASTM E 1592-05: Test Method for Structural Performance of Sheet Metal Wall and Siding Systems by Uniform Static Air Pressure Difference
  18. ASTM E 1980-01: Practice for Calculating Solar Reflectance Index of Horizontal and Low-Sloped Opaque Surfaces
  19. ASTM E 2140-01: Test Method for Weather Penetration of Metal Wall Panel Systems by Static Water Pressure Head
- B. FM Global
1. FMG 4471-1995: Approval Standard, Class I Panel Roofs
  2. Approval Guide 2005
- C. Sheet Metal and Air Conditioning Contractors' National Association
1. SMACNA Architectural Sheet Metal Manual. 2003.
- D. SSPC - Steel Structures Painting Council:
1. SSPC-Paint 12-82 (Revised 2000):: Cold Applied Asphalt Mastic (Extra Thick Film)
- E. UL-Underwriters Laboratories:
1. UL 580-1994 (Rev. 1998): Tests for Uplift Resistance of Wall Assemblies.
  2. Fire Resistance Directory. 2005.
- 1.05 SUBMITTALS
- A. General: Comply with Division 01 Section "Submittals"

- B. Product Data: For each type of product indicated. Include construction details, material descriptions, dimensions of individual components and profiles, and finishes for each type of wall panel and accessory.
  - C. Shop Drawings: Show fabrication and installation layouts of metal wall panels; details of edge conditions, side-seam and endlap joints, panel profiles, corners, anchorages, trim, flashings, closures, and accessories; and special details. Distinguish between factory- and field-assembled work. Shop drawings shall contain wind uplift calculations per ASCE 7. Shop drawings shall be completed by the roofing system manufacturer's engineering department and stamped by a licensed professional structural engineer (California).
    - 1. Accessories: Include details of the following items, at a scale of not less than 1-1/2 inches per 12 inches:
      - a. Flashing and trim.
  - D. Samples for Initial Selection: For each type of metal wall panel indicated with factory-applied color finishes.
    - 1. Include similar Samples of trim and accessories involving color selection.
  - E. Samples for Verification: For each type of exposed finish required, prepared on Samples of size indicated below:
    - 1. Metal wall Panels: 12 inches long by actual panel width. Include fasteners, closures, and other metal wall panel accessories.
    - 2. Trim and Closures: 12 inches long. Include fasteners and other exposed accessories.
    - 3. Accessories: 12-inch- long Samples for each type of accessory.
  - F. Coordination Drawings: Roof plans, drawn to scale, on which the following are shown and coordinated with each other, based on input from installers of the items involved:
    - 1. Wall panels and attachments.
  - G. Manufacturer Certificates: Signed by manufacturer certifying that wall panels comply with energy performance requirements specified in "Performance Requirements" Article.
    - 1. Submit evidence of meeting performance requirements.
  - H. Qualification Data: For qualified Installer.
  - I. Product Test Reports: Based on evaluation of comprehensive tests performed by a qualified testing agency, for each product.
  - J. Field quality-control reports.
  - K. Maintenance Data: For metal wall panels to include in maintenance manuals.
  - L. Warranties: manufacturer's 20 year warranty.
- 1.06 QUALITY ASSURANCE
- A. Installer Qualifications: An employer of workers trained and approved by manufacturer.
  - B. Testing Agency Qualifications: Qualified according to ASTM E 329 for testing indicated.

- C. Source Limitations: Obtain each type of metal wall panels, low slope roofing and wall panel from a single manufacturer.
- D. Preinstallation Conference: Conduct conference at Project site.
  - 1. Meet with Owner, Architect, Owner's insurer if applicable, testing and inspecting agency representative, metal wall panel Installer, metal wall panel manufacturer's representative, deck installer, and installers whose work interfaces with or affects metal wall panels including installers of wall accessories and roof-mounted equipment.
  - 2. Review and finalize construction schedule and verify availability of materials, Installer's personnel, equipment, and facilities needed to make progress and avoid delays.
  - 3. Review methods and procedures related to metal wall panel installation, including manufacturer's written instructions.
  - 4. Examine deck substrate conditions for compliance with requirements, including flatness and attachment to structural members.
  - 5. Review structural loading limitations of deck during and after roofing.
  - 6. Review flashings, special wall details, wall drainage, wall penetrations, equipment curbs, and condition of other construction that will affect metal wall panels.
  - 7. Review governing regulations and requirements for insurance, certificates, and testing and inspecting if applicable.
  - 8. Review temporary protection requirements for metal wall panel assembly during and after installation.
  - 9. Review wall observation and repair procedures after metal wall panel installation.
  - 10. Document proceedings, including corrective measures and actions required, and furnish copy of record to each participant.

#### 1.07 DELIVERY, STORAGE, AND HANDLING

- A. Deliver components, sheets, metal wall panels, and other manufactured items so as not to be damaged or deformed. Package metal wall panels for protection during transportation and handling.
- B. Unload, store, and erect metal wall panels in a manner to prevent bending, warping, twisting, and surface damage.
- C. Stack metal wall panels on platforms or pallets, covered with suitable weathertight and ventilated covering. Store metal wall panels to ensure dryness. Do not store metal wall panels in contact with other materials that might cause staining, denting, or other surface damage.
- D. Protect strippable protective covering on metal wall panels from exposure to sunlight and high humidity, except to extent necessary for period of metal wall panel installation.

#### 1.08 PROJECT CONDITIONS

- A. Weather Limitations: Proceed with installation only when existing and forecasted weather conditions permit metal wall panel work to be performed according to manufacturer's written instructions and warranty requirements.
- B. Field Measurements: Verify actual dimensions of construction contiguous with metal wall panels by field measurements before fabrication.

1.09 COORDINATION

- A. Coordinate sizes and locations of wall curbs, equipment supports, and wall penetrations with actual equipment provided.
- B. Coordinate metal wall panels with rain drainage work, flashing, trim, and construction of decks, parapets, walls, and other adjoining work to provide a leak proof, secure, and noncorrosive installation.

1.10 DESIGN AND PERFORMANCE CRITERIA

A. Thermal Expansion and Contraction:

- 1. Completed metal wall panel and flashing system shall be capable of withstanding expansion and contraction of components caused by changes in temperature without buckling, producing excess stress on structure, anchors or fasteners, or reducing performance ability.
- 2. The design temperature differential shall be not less than <insert design temperature differential [200] °F.
- 3. Interface between panel and clip shall provide for unlimited thermal movement in each direction along the longitudinal direction.

B. Uniform wind load capacity:

- 1. Installed wall panel system shall withstand negative design wind loading pressures complying with the following criteria. Anchor clips shall be installed exactly as spacing given in article 3.0.
- 2. Location of metal wall panel rigid connector shall be designed, per job condition, by the wall panel system manufacturer.
  - a. Design Code: ASCE 7, Method 2 for Components and Cladding.
  - b. Safety Factor: The panel system shall withstand a “proof load” equal to 150% of the design wind pressure, as per the ASTM E330 testing standard.
  - c. Category III Building with an Importance Factor of 1.15.
  - d. Wind Speed: 120 mph.
  - e. Exposure Category: C.
- 3. Capacity shall be determined using uniform static air pressure method in accordance with ASTM E330. Allowable safe working loads shall be determined by dividing the ultimate test load by the safety factor specified above.



- C. ASTM E283: Static pressure air infiltration (doors, windows, curtain walls):
  - 1. Pressure Leakage Rate
    - a. 1.57 PSF 0.06 cfm/sq.ft.
- D. ASTM E330: Uniform static load test for structural performance for standard panel profile. Test results must provide an allowable pressure of no less than:
  - 1. 100 lbs/sqft. for 1'-0" spans
- E. ASTM E331: Static pressure water infiltration (doors, windows, curtain walls):
  - 1. Pressure Result: No Leakage
    - a. 5 Gal. /Hr. per S.F. and Static
    - b. Pressure of 12.0 Psf. for 15 minutes.
- F. Missile Impact Test and Cyclic Wind Pressure Test: The panel system shall be tested in accordance with ASTM E1886 and E1996 [or] FBC Test Protocols TAS 201 and TAS 203.

#### 1.010 WARRANTY

- A. Special Warranty: Manufacturer's standard form in which manufacturer agrees to repair or replace metal wall panel assemblies that fail in materials or workmanship within specified warranty period.
  - 1. Failures include, but are not limited to, the following:
    - a. Structural failures including rupturing, cracking, or puncturing.
    - b. Deterioration of metals, and other materials beyond normal weathering.
  - 2. Warranty Period: 20 years from date of Substantial Completion.
  - 3. Contractor's warranty: 2 years.

#### PART 2 - PRODUCTS

##### 2.01 METAL WALL PANEL SYSTEM:

- A. General: Whenever a particular make of material, trade name and/or manufacturer's name is specified herein, it is the minimum standard of quality required.
  - 1. Product names for the metal roof panel system and waterproofing materials used in this section are based on performance requirements and characteristics of the Latitude Wall panel system from materials manufactured by IMETCO and form the basis of the contract documents.
  - 2. Manufacturers:
    - a. IMETCO; Latitude wall panel, 415 971 2739

- b. Approved equal.

## 2.02 PANEL MATERIALS

- A. Sheet Metal: form wall panels, trim and flashings galvanized steel sheet. Panel finish shall be a smooth machined finish.
  1. Galvanized Steel: ASTM A 653/A 653M, with G90/Z275 zinc coating; minimum 0.025 inch thick base metal, minimum thickness 24 gauge and greater as required by referenced standards for specific applications indicated.
  2. Color shall be: IMETCO's full color range.
- B. Panel Sealants:
  1. Sealant Tape: Pressure-sensitive, 100 percent solids, gray polyisobutylene compound sealant tape with release-paper backing. Provide permanently elastic, nonsag, nontoxic, nonstaining tape 1/2 inch wide and 1/8 inch thick.
  2. Joint Sealant: ASTM C 920; elastomeric polyurethane, polysulfide, or silicone sealant; of type, grade, class, and use classifications required to seal joints in metal wall panels and remain weathertight; and as recommended in writing by metal wall panel manufacturer.
  3. Butyl-Rubber-Based, Solvent-Release Sealant: ASTM C 1311.
- C. Characteristics:
  1. Profile: IMETCO LW12S-4
  2. Fabrication: Panels shall be factory roll-formed from the specified metal. Field rolled panels will not be allowed.
  3. Panels shall be as indicated on project drawings.
    - a. The standard profile shall be flat.
    - b. Panel shall have endfolds at each end of the panel.
    - c. Reveal backer plate shall be made out of the same material as the wall panel.
  4. Panel orientation: Horizontal.
  5. Configuration: Panel shall be 12" wide (nominal) with interlocking seams at top and bottom incorporating concealed anchor clips allowing thermal movement.
  6. Panel Depth (Concealed Leg Height): 7/8" (nominal).
  7. Panel lengths: Up to 20 feet maximum length.
  8. Reveal 3/4" .
- D. Accessories:
  1. Anchor Clips: Clips shall be 18 gauge stainless steel designed to allow thermal movement of the panel in each direction along the longitudinal dimension.
  2. Fasteners:
    - a. Concealed fasteners: Corrosion resistant steel screws, #14 x length appropriate for substrate, hex washer head. Use self-drilling, self-tapping for metal substrate or A-point for plywood substrate.
    - b. Exposed fasteners: 300 series stainless steel screws (cadmium or zinc coatings are not acceptable) or one eighth (1/8) inch diameter stainless steel waterproof rivets. All exposed fasteners shall be factory painted to match the color of the wall panels.
  3. Provide all miscellaneous accessories for complete installation.

## 2.03 ACCESSORY PRODUCTS

- A. Sealant:
  1. Acceptable product:
    - a. Concealed Application: Non-curing butyl sealant or equal.

- b. Exposed Application: Garland SS sealant or equal.
- 2. Colors: As selected by architect from sealant manufacturer's standard selection.
- B. Foam Closures: Inside corners, outside corners, door and window jambs, and batten reveal terminations: Factory precut closed cell foam meeting ASTM D1056 and/or D3574.

### **2.03 FABRICATION**

- A. Shop fabricate metal panels and flashing components to the maximum extent possible, forming metal work with clear, sharp, straight, and uniform bends and rises. Hem exposed edges of flashings.
- B. Form flashing components from full single width sheet in minimum ten (10'-0") feet sections. Provide shop fabricated, mitered corners, joined using closed end pop rivets and joint sealant.
- C. Fabricate panels and related sheet metal work in accordance with approved shop drawings and applicable standards.

## **PART 3 – EXECUTION**

### **3.01 EXECUTION, GENERAL**

- A. Comply with requirements of Division 01 Section "Common Execution Requirements."

### **3.02 PREPARATION**

- A. Inspection: Examine the alignment and placement of the building structure and substrate. Correct any objectionable warp, waves or buckles in the substrate before proceeding with installation of the pre-formed metal panels.
- B. Pre-installation conference: Prior to beginning metal wall panel work, convene a pre-installation conference as specified in Part 1 of this Specification.

### **3.03 INSTALLATION, GENERAL**

- A. Install wall system when the atmospheric dry bulb temperature is minimum forty (40) degrees Fahrenheit and rising.
- B. Install all components of the roof system in exact accordance with the manufacturer's standard published procedures as applicable to these project conditions and substrates.

### 3.04 WALL PANEL INSTALLATION

- A. Comply with all details and install wall materials and flashings in accordance with approved Manufacturer's shop drawings and manufacturer's product data within specified erection tolerances.
- B. Isolate dissimilar metals and masonry or concrete from metals with bituminous coating. Use gasketed fasteners where required to prevent corrosive action between fastener, substrate, and panels.
- C. Limit exposed fasteners to extent indicated on shop drawings.
- D. Anchorage shall allow for temperature expansion/contraction movement without stress or elongation of panels, clips, or anchors. Attach clips to substrate using fasteners of size and spacing as determined by manufacturer's design analysis to resist specified wind pressure and thermal movement forces.
- E. Seal laps and joints in accordance with system manufacturer's product data.
- F. Coordinate flashing and sheet metal work to provide weathertight conditions at wall panel terminations. Fabricate and install in accordance with standards of SMACNA Manual.
- G. Provide for temperature expansion/contraction movement of panels at wall panel penetrations and wall panel mounted equipment, in accordance with system manufacturer's product data and design calculations.
- H. Installed system shall be true to line and plane and free of dents, and physical defects. In light gauge panels with wide flat surfaces, some oil canning may be present. Oil canning does not affect the finish or structural integrity of the panel and is therefore not cause for rejection.
- I. Form joints in linear sheet metal to allow for one fourth (1/4) inch minimum expansion at twenty (20'-0") feet on center maximum and eight (8'-0") feet from corners.
- J. At joints in linear sheet metal items, set sheet metal items in two (2) one fourth (1/4) inch beads of butyl sealant. Extend sealant over all metal surfaces. Mate components for positive seal. Allow no sealant to migrate onto exposed surfaces.

### 3.05 CLEANING

- A. Clean installed work in accordance with the manufacturer's instructions.
- B. Replace damaged work than cannot be restored by normal cleaning methods.

### **3.06 CONSTRUCTION WASTE MANAGEMENT**

- A. Remove and properly dispose of waste products generated during construction. Comply with requirements of authorities having jurisdiction

### **3.07 FINAL INSPECTION**

- A. At completion of installation and associated work, meet with Contractor, Architect, installer, installer of associated work, Owner, system manufacturer's representative, and other representatives directly concerned with performance of system.
- B. Inspect work and flashing of penetrations, walls, curbs and other equipment. List all items requiring correction or completion and furnish copy of list to each party in attendance.
- C. Repair or replace deteriorated or defective work found at time above inspection as required to a produce an installation which is free of damage and deterioration at time of Substantial Completion and according to warranty requirements.
- D. Notify the Contractor upon completion of corrections.
- E. Following the final inspection, provide written notice of acceptance of the installation from the system manufacturer.
- F. Immediately correct leakage during construction. If the Contractor does not respond within twenty four (24) hours, the Owner will exercise rights to correct the Work under the terms of the Conditions of the Contract.

END OF SECTION 07 4150

**SECTION 07 5550  
MODIFIED BITUMEN ROOFING**

**PART 1 - GENERAL**

**1.01 SCOPE OF WORK**

- A. The work under this contract shall include all, labor, materials, tools, transportation, equipment, services, and facilities necessary for, and reasonably incidental to, the completion of the work as shown on the drawings and/or described in the specifications.

**1.02 RELATED SECTIONS**

- A. Section 07 2200 - Roof Insulation
- B. Section 07 6100 - Sheet Metal Flashing and Trim
- C. Section 07 7100 - Roof Specialties
- D. Section 07 7200 - Roof Accessories

**1.03 REFERENCES**

- ASTM D - 41 Specification for Asphalt Primer Used in Roofing, Damp proofing, and Waterproofing
- ASTM D - 312 Specification for Asphalt Used in Roofing
- ASTM D - 5147 1991 Test Method for Sampling and Testing Modified Bituminous Sheet Materials
- ASTM E - 108 Test Methods for Fire Test of Roof Coverings
- ASTM B69-98a Standard Specification for Zinc Sheet.

**1.04 SUBMITTALS FOR REVIEW**

- A. Product Data: Provide manufacturer's technical product data for each type of roofing product specified. Include data substantiating that materials comply with specified requirements. Include data substantiating that materials comply with the minimum specified requirements including rubber content, low temperature flexibility, tensile strength, tear strength, and amount of recycled content (post consumer and post industrial).
- B. Samples: Submit four (4) samples of the following:
  - 1. Cap Sheet
  - 2. SBS Modified Base Sheet

- C. Specimen Warranty: Provide an unexecuted copy of the 30 year No Dollar Limit water tight warranty covering every part of the Built Up Roofing system specified for this Project, identifying the terms and conditions required of the Manufacturer and the Owner.
- D. Any material submitted as equal to or better than the specified material must be accompanied by a report signed and sealed by a professional engineer licensed in the state in which the installation is to take place. This report shall show that the submitted equal meets the Design and Performance criteria in this specification.
- E. Substitution requests submitted without licensed engineer stamp will be rejected for non-conformance.

#### **1.05 SUBMITTALS FOR INFORMATION**

- A. Manufacturer's Installation Instructions: Submit installation instructions and recommendations indicating special precautions required for installing the membrane.
- B. Manufacturer's Certificate: Certify that roof system furnished is approved by Factory Mutual, Underwriters Laboratories, Warnock Hersey or approved third party testing facility in accordance with ASTM E108, Class A for external fire and meets local or nationally recognized building codes.
- C. Manufacturer's Certificate: Certify that the roof system furnished is approved or accepted by Factory Mutual Approval Standard 4470.
- D. Manufacturer's Certificate: Certify that materials are manufactured in the United States and conform to requirements specified herein, are chemically and physically compatible with each other, and are suitable for inclusion within the total roof system specified herein.
- E. Manufacturer's Certificate: Submit a certified copy of the roofing manufacturer's ISO 9001 compliance certificate.
- F. Test Reports: Submit test reports, prepared by an independent testing agency, for all modified bituminous sheet roofing, indicating compliance with ASTM D5147.
- G. Written certification from the roofing system manufacturer certifying the applicator is currently authorized for the installation of the specified roof system.
- H. Design Wind Loads: Submit copy of manufacturer's minimum design load calculations according to ASCE 7, Method 2 for Components and Cladding, sealed by a registered professional structural engineer employed by the system manufacturer as a full-time staff engineer. In no case shall the design loads be taken to be less than those detailed in Design and Performance Criteria article of this specification.
- I. Qualification data for firms and individuals identified in Quality Assurance Article below.

- J. Notarized statement from the Roofing System Manufacturer, signed by an Officer of the Corporation with the Corporate Seal affixed there to stating that the Roofing System Manufacturer will provide field inspections three times a week during the entire period of installation until all construction is completed and to be performed by a full time employee of the manufacturer at no additional cost to the owner.
- K. Plumbing calculation: roofing system manufacturer to supply plumbing calculation verifying all scuppers are properly sized.

#### **1.06 CONTRACT CLOSEOUT SUBMITTALS**

- A. General: Comply with Requirements of Division 01 Section - Closeout Submittals.
- B. Special Project Warranty: Provide specified warranty for the Project, executed by the authorized agent of the Manufacturer.
- C. Roofing Maintenance Instructions. Provide a manual of manufacturer's recommendations for maintenance of installed roofing systems.
- D. Insurance Certification: Assist Owner in preparation and submittal of roof installation acceptance certification as may be necessary in connection with fire and extended coverage insurance on roofing and associated work.
- E. Demonstration and Training Schedule: Provide a schedule of proposed dates and times for instruction of Owner's personnel in the maintenance requirements for completed roofing work. Refer to Part 3 for additional requirements.

#### **1.07 QUALITY ASSURANCE**

- A. Installer Qualifications: Installer (Roofing) shall be specializing in modified bituminous roof application with minimum 5 years experience and who is certified by the roofing system manufacturer as qualified to install manufacturer's roofing materials.
- B. It is the intent of this specification to provide a roof system with an external fire rating. The descriptions given below are general descriptions. The insulation, recovery board, and other components shall be as required by the membrane manufacturer to provide a Class A fire resistance rating.
- C. Installer's Field Supervision: Require Installer to maintain a full-time Supervisor/Foreman on the job site during all phases of modified bituminous sheet roofing work and at any time roofing work is in progress: proper supervision of workmen shall be maintained. A copy of the specification shall be in the possession of the Supervisor/Foremen and on the roof at all times.
- D. It shall be the Contractor's responsibility to respond immediately to correction of roof leakage during construction.



- E. Disqualification of Bidders: A Bidder can be disqualified by the Owner's representative or Owner for any of the following reasons, but not limited to:
1. The failure to attend the Pre-Bid conference at the time and place so described under Bidding Dates.
  2. Incorrect use of the "Proposal" as provided by the Owner's representative/Owner. Any changes in said format shall be accepted by the Owner's representative/Owner only when requested and approved in writing prior to the bid opening. Changes in the Proposal after the opening of the bids will not be accepted.
  3. Lack of proficiency as shown by past work or incomplete work under other contracts which, in the judgment of the Owner's representative/Owner, might hinder or prevent the prompt completion of additional work if so awarded or any involvement in any legal actions which relate to past or present performance. This includes, but is not limited to, law suits, court appointed actions, and/or ongoing litigation.
- G. Insurance Certification: Assist Owner in preparation and submittal of roof installation acceptance certification as may be necessary in connection with fire and extended coverage insurance on roofing and associated work.
- H. Pre-application Roofing Conference: Approximately 2 weeks before scheduled commencement of modified bitumen sheet roof system and associated work, meet at Project site with Installer, installer of each component of associated work, installers of deck or substrate construction to receive roofing work, installers of rooftop units and other work in the around roofing that must precede or follow roofing work (including mechanical work if any), Owner's representative/Owner, roofing system manufacturer's representative, and other representatives directly concerned with performance of the Work, including (where applicable) Owner's insurers, test agencies, and governing authorities. Objectives to include:
1. Review foreseeable methods and procedures related to roofing work.
  2. Tour representative areas of roofing substrates (decks), inspect and discuss condition of substrate, roof drains, curbs, penetrations, and other preparatory work performed by other trades.
  3. Review structural loading limitations of deck and inspect deck for loss of flatness and for required attachment.
  4. Review roofing systems requirements (drawings, specifications, and other contract documents).
  5. Review required submittals, both completed and yet to be completed.
  6. Review and finalize construction schedule related to roofing work and verify availability of materials, Installer's personnel, equipment, and facilities needed to make progress and avoid delays.

7. Review required inspection, testing, certifying, and material usage accounting procedures.
8. Review weather and forecasted weather conditions and procedures for coping with unfavorable conditions, including possibility of temporary roofing (if not a mandatory requirement).
9. Record (contractor) discussion of conference, including decisions and agreements (or disagreements) reached, and furnish copy of record to each party attending. If substantial disagreements exist at conclusion of conference, determine how disagreements will be resolved and set date for reconvening conference.
10. Review notification procedures for weather or non-working days.

#### **1.08 DELIVERY, STORAGE AND HANDLING**

- A. Deliver products to site with seals and labels intact, in manufacturer's original containers, dry and undamaged.
- B. Store and handle roofing sheets in a dry, well-ventilated, weather-tight place to ensure no possibility of significant moisture exposure. Store rolls of felt and other sheet materials on pallets or other raised surface. Stand all roll materials on end. Cover roll goods with a canvas tarpaulin or other breathable material (not polyethylene).
- C. Do not leave unused rolled goods on the roof overnight or when roofing work is not in progress unless protected from weather and other moisture sources.
- D. Handle and store materials or equipment in a manner to avoid significant or permanent deflection of deck.

#### **1.09 MANUFACTURER'S INSPECTIONS**

- A. When the project is in progress, the Roofing System Manufacturer will provide the following:
  1. Keep the Owner's representative informed as to the progress and quality the work as observed.
  2. Provide job site inspections a minimum of three days a week.
  3. Report to the Owner's representative in writing, any failure or refusal of the Contractor to correct unacceptable practices called to the Contractor's attention.
  4. Confirm, after completion of the project and based on manufacturer's observations and tests, that manufacturer has observed no applications procedures in conflict with the specifications other than those that may have been previously reported and corrected.

#### **1.10 PROJECT CONDITIONS**

- A. Weather Condition Limitations: Do not apply roofing membrane during inclement weather or when a 40% chance of precipitation is expected.
- B. Do not apply roofing insulation or membrane to damp deck surface.
- C. Do not expose materials vulnerable to water or sun damage in quantities greater than can be weatherproofed during same day.
- D. Proceed with roofing work only when existing and forecasted weather conditions will permit unit of work to be installed in accordance with manufacturer's recommendations and warranty requirements.

#### **1.11 SEQUENCING AND SCHEDULING**

- A. Sequence installation of modified bituminous sheet roofing with related units of work specified in other sections to ensure that roof assemblies, including roof accessories, flashing, trim, and joint sealers, are protected against damage from effects of weather, corrosion, and adjacent construction activity.
- B. All work must be fully completed on each day. Phased construction will not be accepted.

#### **1.12 WARRANTY**

- A. Membrane Manufacturer upon completion of installation, and acceptance by the Owner and Owner's representative, the manufacturer will supply to the Owner a 30 year labor and material warranty.
- B. Contractor will submit a minimum of a two year warranty to the membrane manufacturer with a copy directly to Owner.

#### **1.13 DESIGN AND PERFORMANCE CRITERIA**

- A. Uniform Wind Uplift Load Capacity
  - 1. Installed roof system shall withstand negative (uplift) design wind loading pressures complying with the following criteria. Attachment shall be installed exactly as given in Part 3. (To be included with bid documents)
    - a. Design Code: ASCE 7, Method 2 for Components and Cladding.
    - b. Category III Building with an Importance Factor of 1.0
    - c. Wind Speed: 120 MPH
    - d. Exposure Category: C

### **PART 2 - PRODUCTS**

#### **1.01 GENERAL**

- A. When a particular trade name or performance standard is specified it shall be indicative of a standard required. Provide materials by: The Garland Company or approved equal, Jay Mulligan, (415) 971-2739.

- B. Any item or materials submitted as an alternate to the manufacturer specified must comply in all respects as to the quality and performance, including job site investigation of the brand name specified. The Owner's representative/Owner shall be the sole judge as to whether or not an item submitted as an equal is truly equal. Should the contractor choose to submit on the equal basis, he shall assume all risk involved, monetary or otherwise, should the Owner's representative/Owner find it unacceptable.

## 2.02 ROOFING

- A. Materials: insulation, modified base sheet, and modified capsheet membrane and surfacing.
  - 1. Base ply: the smooth surfaced modified membrane will be: HPR SA IV base sheet, SBS modified base sheet.
  - 2. Modified membrane with coated finish: Stressply IV UV Mineral, smooth. Dual reinforced, fire resistant, SBS modified bitumen.
  - 3. Base flashing base ply: HPR SA IV.
  - 4. Flashing capsheet: 195 mil mineral surfaced modified membrane.

## 2.03 MODIFIED BITUMEN MEMBRANE PERFORMANCE REQUIREMENTS

- A. Tensile Strength, ASTM D 5147
  - 1. 2 in./min. @ 73.4 ± 3.6 °F MD 200 lbf/in XD 200 lbf/in
- B. Tear Strength, ASTM D 5147
  - 1. 2 in./min. @ 73.4 ± 3.6 °F MD 300 lbf XD 300 lbf
- C. Elongation at Maximum Tensile, ASTM D 5147
  - 1. 2 in./min. @ 73.4 ± 3.6 °F MD 3.5% XD 3.5%
- D. Low Temperature Flexibility, ASTM D 5147, Passes -30 degreesF (-34

## 2.04 BITUMINOUS MATERIALS

- A. Primer: V.O.C. compliant, ASTM D-41.
- B. Asphalt Roofing Mastic: V.O.C. compliant, Silver Flash, ASTM D-2822, Type II.
- C. Insulation adhesive: as approved by roofing system manufacturer.

## 2.05 RELATED MATERIALS

- A. Caulking and sealant: Tuff-Stuff urethane caulking.
- B. WalkPads: APOC, 1/2" min.
- C. Gravel for roof: ASTM 1863 clean river rock.
- D. Gravel adhesive: Weathercreen asphalt cutback.
- E. Zinc drain pans and pipe flashing: ASTM B69-98a, 99.95% pure zinc.

Zincjak: Viking Products Group, [www.vikingpg.com](http://www.vikingpg.com)

1. Thickness: 0.02".
2. Pipe flashing: interior coated.
3. Drain pans: pretreated both sides with factory primer topside coating.
4. Lead free solder for zinc: SN 100C, Aim Solder, <http://www.aimsolder.com/>.
5. Flux for zinc: #17 or #70, Superior Flux Mfg. Co., [www.superiorflux.com/](http://www.superiorflux.com/).

## 2.06 SURFACINGS

- A. White Elastomeric Roof Coating: Pyramic LO; Energy Star approved white urethane modified acrylic roof coating as indicated on drawings:
  1. Reflectance 81%

## PART 3 EXECUTION

### 3.01 EXAMINATION

- A. Examine substrate surfaces to receive modified bitumen sheet roofing system and associated work and conditions under which roofing will be installed. Do not proceed with roofing until unsatisfactory conditions have been corrected in a manner acceptable to Installer.

### 3.02 GENERAL INSTALLATION REQUIREMENTS

- A. Cooperate with manufacturer, inspection and test agencies engaged or required to perform services in connection with installing modified bitumen roofing system.
- B. Insurance/Code Compliance: Where required, install and test modified bitumen roofing system to comply with governing regulations and specified insurance requirements.
- C. Protect other work from spillage of modified bitumen roofing materials, and prevent liquid materials from entering or clogging drains and conductors. Replace or restore other work damaged by installations of modified bituminous roofing system work.
- D. Coordinate installing roofing system components so that insulation and roofing plies are not exposed to precipitation or left exposed overnight. Provide cut offs at end of each day's work to cover exposed ply sheets with two (2) plies of #15 organic felt set in mastic and with joints and edges sealed with roofing cement. Remove cut offs immediately before resuming work.
- E. Substrate Joint Penetrations: Prevent bitumen from penetrating substrate joints, entering building, or damaging roofing system components or adjacent building construction.
- F. Apply roofing materials as specified herein unless recommended otherwise by manufacturer's instructions. Keep roofing materials dry before and during application. Do not permit phased construction. Complete application of roofing plies, modified sheet

and flashing in a continuous operation. Begin and apply only as much roofing in one day as can be completed that same day.

**3.03 BASE PLY INSTALLATION**

- A. Base ply: Install base ply shingled uniformly to achieve one ply throughout over the prepared substrate. Shingle in proper direction to shed water on each area of roof.
- C. Stagger end laps twelve inches minimum.
- D. Extend ply two inches beyond top edges of cants at wall and projection bases.
- E. Install base flashing ply to all perimeter and projections details.

**3.04 MODIFIED MEMBRANE APPLICATION**

- A. Starting at the low point, apply StressPly IV UV Mineral in the desired position.
- B. Care should be taken to eliminate air entrapment under the membrane.
- C. Apply pressure to all seams to ensure that the laps are solidly bonded to substrate.
- D. Subsequent rolls of modified shall be installed across the roof as above with a minimum of 4" side laps and 8" end laps. The end laps shall be staggered. The modified membrane shall be laid in the same direction as the underlayers, but the laps shall not coincide with the laps of the base layers. Adhere all end laps with mastic.
- E. Extend membrane 2" beyond top edge of all cants in full moppings of the specified asphalt as shown on the drawings.
- F. Seal top of membrane at end of each day.
- G. Base and should be installed same day.

**3.05 FLASHING MEMBRANE APPLICATION (GENERAL)**

- A. All curb, wall and parapet flashings shall be sealed with an application of mastic and mesh on a daily basis. No condition should exist that will permit moisture entering behind, around, or under the roof or flashing membrane.
- B. Prepare all walls, penetrations and expansion joints to be flashed and where shown on the drawings, with asphalt primer at the rate of one gallon per 100 square feet Allow primer to dry tack free.
- C. The modified membrane will be used as the flashing membrane and will be adhered to an underlying base flashing ply and nailed off 8" O.C. at all vertical surfaces. Over 12" the modified membrane will be 80 mils with a mineral cap sheet installed over the top.
- D. The entire sheet of flashing membrane must be solidly adhered to the substrate.

- E. Seal all vertical laps of flashing membrane with a three course application of Flashing Bond and fiberglass mesh.
- F. Counter flashing, cap flashings, expansion joints, and similar work to be coordinated with modified bitumen roofing work are specified in other sections.
- F. Roof accessories, miscellaneous sheet metal accessory items, including piping vents and other devices to be coordinated with modified bituminous roof system work are in other sections.
- G. Ensure all flashing are nailed off and sealed with a three course application of mastic and mesh.

### **3.06 APPLICATION OF SURFACING**

- A. Prior to installation of surface, obtain approval from manufacturer as to work completed.
  - 1. Reflective coating: Apply Pyramic LO at two gallons per sq. per coat. Apply one coat.

### **3.07 CLEANING**

- A. Remove drippage of bitumen from all walls, windows, floors, ladders, and finished surfaces.
- B. In areas where finished surfaces are soiled by asphalt or any other sources of soiling caused by work of this section, consult manufacturer of surfaces for cleaning advice and conform to their instructions.

### **3.10 FINAL INSPECTION**

- A. At completion of roofing installation and associated work, meet with Installer, installer of associated work, Owner, roofing system manufacturer's representative, and other representatives directly concerned with the performance of the roofing system.
- B. Walk roof surface areas of the building, inspect perimeter building edges as well as flashing of roof penetrations, walls, curbs and other equipment. List all items requiring correction or completion and furnish copy of list to each party attending.
- C. The Roofing System Manufacturer reserves the right to request a thermographic scan of the roof during final inspection to determine if any damp or wet materials have been installed. The thermographic scan shall be provided by the Roofing Contractor at a negotiated price.
- D. If core cuts verify the presence of damp or wet materials, the Roofing Contractor shall be required to replace the damaged areas at his own expense.
- E. Repair or replace (as required) deteriorated or defective work found at time above inspection to a condition free of damage and deterioration at time of Substantial Completion and according to warranty requirements.

- F. The Contractor is to notify the Owner upon completion of corrections.
- G. Following the final inspection, acceptance will be made in writing by the material manufacturer.

END OF SECTION



**SECTION 07 6200**  
**SHEET METAL FLASHING AND TRIM**

**PART 1 GENERAL**

**1.01 SECTION INCLUDES**

- A. Fabricated sheet metal items, including flashings, counterflashings, gutters, downspouts, and other items indicated in Schedule and as follows:
  - 1. Edge strip and flashing.
  - 2. Counterflashings for roof accessories, roof mounted equipment, vent stacks and similar items.
- B. Sealants for joints within sheet metal fabrications.
  - 1. Plaster stops, terminations and miscellaneous custom shapes not otherwise provided by Section 09 2400.
- C. Foam Sealer tape for sheet metal and flashing applications.

**1.02 RELATED REQUIREMENTS**

- A. Section 06 1000 - Rough Carpentry: Wood curbs and nailers.
- B. Section 07 7100 - Roof Specialties: Copings and Preformed flashings.
- C. Section 07 7200 - Roof Accessories: Manufactured metal roof curbs.
- D. Section 07 9005 - Joint Sealers.

**1.03 REFERENCE STANDARDS**

- A. ASTM A653/A653M - Standard Specification for Steel Sheet, Zinc-Coated (Galvanized) or Zinc-Iron Alloy-Coated (Galvannealed) by the Hot-Dip Process.
- B. ASTM A792 Steel Sheet, Aluminum-Zinc Alloy-Coated, by the Hot-Dip Process
- C. ASTM B32 - Standard Specification for Solder Metal.
- D. ASTM B209 - Standard Specification for Aluminum and Aluminum-Alloy Sheet and Plate.
- E. ASTM B209M - Standard Specification for Aluminum and Aluminum-Alloy Sheet and Plate [Metric].
- F. ASTM B486 Paste Solder
- G. ASTM C920 - Standard Specification for Elastomeric Joint Sealants.
- H. ASTM D226/D226M - Standard Specification for Asphalt-Saturated Organic Felt Used in Roofing and Waterproofing.
- I. ASTM D2178/D2178M - Standard Specification for Asphalt Glass Felt Used in Roofing and Waterproofing.
- J. ASTM D4479/D4479M - Standard Specification for Asphalt Roof Coatings - Asbestos-Free.
- K. ASTM D4586/D4586M - Standard Specification for Asphalt Roof Cement, Asbestos-Free.
- L. California Code of Regulations, Title 24, Part 2, California Building Code (CBC), International Building Code
- M. California Code of Regulations, Title 24, Part 11 California Green Building Standards Code, "CAL-Green".
- N. FS QQ-L-201 Specification for Lead Sheet

- O. SMACNA (ASMM) - Architectural Sheet Metal Manual; Sheet Metal and Air Conditioning Contractors' National Association.
- P. WH Warnock Hersey International, Inc. Middleton, WI.
- Q. FM Loss Prevention Data Sheet.
- R. NRCA National Roofing Contractors Association - Roofing Manual.
- S. Manufacturer's recommendations and specifications.

#### **1.04 SUBMITTALS**

- A. See Section 01 3300 - Submittals, for submittal procedures.
- B. Shop Drawings: Indicate material profile, jointing pattern, jointing details, fastening methods, flashings, terminations, and installation details.
  - 1. Indicate type, gauge and finish of metal.
- C. Product data: Provide manufacturer's specification data sheets for each product. Demonstrate compliance with specified attributes:
  - 1. Submit color chart for prefinished materials.
  - 2. Metal material characteristics and installation recommendations.
- D. CAL-GREEN Submittals: Product Data - VOC Limits: For adhesives sealants, fillers, primers and coatings, documentation including printed statement of VOC contents, comply with limits specified in related section.
- E. Certification:
  - 1. Submit certification that metal and fastening system furnished is Tested and Approved by DSA IR-5 Wind Up-Lift Requirements.
- F. Provide approval letters from metal manufacturer for use of their metal within this particular roofing system type.
- G. Proof of fabricator and installer qualifications.

#### **1.05 QUALITY ASSURANCE**

- A. Perform work in accordance with SMACNA Architectural Sheet Metal Manual requirements, except as otherwise indicated.
  - 1. Factory Mutual Approval Standard 4435.
- B. Contractor's Warranty: The Contractor shall provide the Owner with a notarized written warranty assuring that all sheet metal work including caulking and fasteners to be water-tight and secure for a period of five years from the date of final acceptance of the building. Warranty shall include all materials and workmanship required to repair any leaks that develop, and make good any damage to other work or equipment caused by such leaks or the repairs thereof.

#### **1.06 DELIVERY, STORAGE, AND HANDLING**

- A. Deliver materials in manufacturer's original, unopened containers or packages with labels intact and legible.
- B. Stack material to prevent twisting, bending, and abrasion, and to provide ventilation. Slope metal sheets to ensure drainage.
- C. Prevent contact with materials that could cause discoloration or staining.

## **PART 2 PRODUCTS**

### **2.01 PERFORMANCE REQUIREMENTS**

- A. VOC Limits for adhesives, sealants, fillers, primers and coatings. Comply with limits specified in related section.

### **2.02 SHEET MATERIALS**

- A. Galvanized Steel: ASTM A 653/A 653M, with G90/Z275 zinc coating; minimum 0.025 inch thick base metal, minimum thickness 24 gauge and greater as required by referenced standards for specific applications indicated.

### **2.03 UTILITY WALL PENETRATION FLASHINGS**

- A. Prefabricated Facility Services Utility Penetration Flashings, sizes and profiles required to suit conditions.
- B. Manufacturer: Quickflash Weatherproofing Products, Inc., 4129 Wagon Trail Avenue, Las Vegas, Nevada 89118. Phone (702) 614-6100. Fax (702) 614-4090. Website [www.quickflashproducts.com](http://www.quickflashproducts.com).
- C. Plumbing Flashing Panels:
  - 1. Materials:
    - a. Panel: Combination of high-density polyethylene (HDPE) and low-density polyethylene (LDPE).
      - 1) HDPE, Specific Gravity, ASTM D 1505: 0.953 g/cm<sup>3</sup>.
      - 2) HDPE, Tensile Strength at Yield, ASTM D 638: 3,100 psi.
      - 3) LDPE, Specific Gravity, ASTM D 792: 0.917 g/cm<sup>3</sup>.
      - 4) LDPE, Tensile Strength at Yield, ASTM D 638: 1,300 psi.
    - b. Weatherproof Seal: Thermoplastic elastomer.
      - 1) Hardness, ASTM D 2240, Shore A, 10 Seconds: 46.
      - 2) Specific Gravity, ASTM D 792: 1.05 g/cm<sup>3</sup>.
      - 3) Tensile Strength, ASTM D 412: 490 psi.
- D. Electrical Flashing Panels:
  - 1. Material: Thermoplastic elastomer.
    - a. Hardness, ASTM D 2240, Shore A, 10 Seconds: 93.
    - b. Specific Gravity, ASTM D 792: 1.05 g/cm<sup>3</sup>.
    - c. Tensile Strength, ASTM D 412: 1,300 psi.

### **2.04 ACCESSORIES**

- A. Reinforcement Metals:
  - 1. Typical: Stainless steel or extruded aluminum.
- B. Fasteners:
  - 1. Corrosion resistant screw fastener as recommended by metal manufacturer. Finish exposed fasteners same as flashing metal.
  - 2. Fastening shall conform to Factory Mutual 1-90 requirements or as stated on section details, whichever is more stringent.
  - 3. Screws, bolts, washers, drive-ins.
- C. Underlayment: Garland R-mer Seal.
- D. Primer: Galvanized iron type.
  - 1. Product: Rust-Oleum 7400 System, Modified Alkyd Zinc Primer, <340 g/l VOC: [www.rustoleum.com](http://www.rustoleum.com).

2. Substitutions: Section 01 6000.
- E. Protective Backing Paint: FS TT-C-494, Bituminous Asphaltic mastic, ASTM D 4479 Type I.
- F. Sealant to be Concealed in Completed Work: Non-curing butyl sealant.
- G. Sealant to be Exposed in Completed Work: ASTM C920; elastomeric sealant, 100 percent silicone with minimum movement capability of plus/minus 25 percent and recommended by manufacturer for substrates to be sealed; clear.
- H. Flexible Flashing: 25 mil (0.64 mm), cold applied, self-adhering membrane consisting of a 3 mil (0.07 mm) high density, cross-laminated polyethylene film coated on one side with a 22 mil (0.56 mm) layer of rubberized asphalt adhesive; W. R. Grace "Vycor Plus".
- I. Sealer Tape: Medium Density Closed Cell EPDM or rubber blend tape single-coated with acrylic adhesive, for use in sheet metal and flashing applications.
  1. Width and Thickness: As required for snug fit under low compression to exclude moisture.
  2. Tensile Strength, ASTM D 412: 65 PSI.
  3. Pres-On; P9100, www.pres-on.com.
  4. 3M
  5. Argent; www.argent-international.
  6. Substitutions: See Section 01 6000 - Product Requirements.
- J. Sealant: Silicone, Type recommended by flashing manufacturer or as specified in Section 07 9005.
- K. Plastic Cement: ASTM D4586/D4586M, Type I.
- L. Flux: FS O-F-506.
- M. Solder: ASTM B 32; Alloy Grade 50A.

## 2.05 FABRICATION - GENERAL

- A. Fabricate in accordance with referenced standards. Form sections true to shape, accurate in size, square, and free from distortion or defects. Form pieces as recommended by SMACNA standard for conditions required.
  1. Provide reinforcements and supports as required for secure anchorage.
  2. Make joints rigid. Seams mechanically strong and soldered or sealed to make watertight
  3. Fabricate corners in one piece with legs extending 30-inches each way to field joint. Lap, rivet, and solder or seal corner seams watertight.
  4. Turn up "end dam" flanges at ends of opening sill flashing pieces, lap with wall flashing and membranes to shed water.
  5. Fabricate cleats of same material as sheet, minimum 3/4 inches wide, interlockable with sheet.
  6. Hem exposed edges on underside 1/2 inch; miter and seam corners.
  7. Solvent clean all sheet metal. Coat surfaces to be in contact with roofing or otherwise concealed with specified asphaltic paint; 0.015-inch minimum uniform thickness.
- B. Fabricate cleats of same material as sheet, 1 gauge heavier, minimum 2 inches wide, interlocking with sheet.
- C. Form pieces in longest possible lengths.
- D. Machine-roll flashing elements and joinery required to be curved or radiused. Do not field bend or "walk-down". Provide true curves and joinery utilizing "Pittsburgh lock" construction, minimizing joints. Segmented fabrication is not acceptable unless specifically noted and dimensioned on drawings.
- E. Hem exposed edges on underside 1/2 inch; miter and seam corners.

- F. Form material with flat lock seams, except where otherwise indicated. At moving joints, use sealed lapped, bayonet-type or interlocking hooked seams.
- G. Fabricate corners from one piece with minimum 18 inch long legs; seam for rigidity, seal with sealant.
- H. Fabricate vertical faces with bottom edge formed outward 1/4 inch and hemmed to form drip.

## **2.06 ROOF-RELATED SHEET METAL AND FLASHINGS**

- A. Roof-Related Sheet Metal and Flashings: As indicated, as specified in related sections, as required by roofing material manufacturers and referenced standards. Coordinate work of this section with related sections. Provide complete systems without conflict or omission.

## **2.07 GUTTER AND DOWNSPOUT FABRICATION**

- A. Gutters: Profile as indicated. 20 gauge minimum.
  - 1. Expansion joints: Lap type; closed ends with cap over flanged tops of gutter ends.
- B. Gutters and Downspouts: Size indicated.
- C. Accessories: Profiled to suit gutters and downspouts.
  - 1. End caps, rain diverters, gutter straps support brackets, joint fasteners: Sized to suit gutters, of matching thickness.
  - 2. Anchorage Devices: In accordance with SMACNA requirements.
  - 3. Gutter Supports: Straps. Fabricate from material of double thickness of gutter fabrication, minimum.
  - 4. Downspout Supports: Straps. Fabricate from material of double thickness of gutter fabrication, minimum.
  - 5. Gutter Outlet Strainers: Stainless steel; Woven wire mesh type, #10 gauge, No.4 mesh minimum.
  - 6. Gutter screens: Gutter screens: powder coated aluminum.
    - a. [www.greengutterscreens.com](http://www.greengutterscreens.com) or approved equal.
- D. Seal prefinished metal joints. Solder other joints.

## **PART 3 EXECUTION**

### **3.01 EXAMINATION**

- A. Verify roof openings, curbs, pipes, sleeves, ducts, and vents through roof are solidly set, reglets in place, and nailing strips located.
- B. Verify roofing termination and base flashings are in place, sealed, and secure.
- C. Beginning of installation means acceptance of existing conditions.
- D. Field measure site conditions prior to fabricating work.

### **3.02 PREPARATION**

- A. Install starter and edge strips, and cleats before starting installation.
- B. Back paint concealed metal surfaces with protective backing paint to a minimum dry film thickness of 15 mil.

### **3.03 INSTALLATION**

- A. Except as otherwise indicated, comply with manufacturer's installation instructions and recommendations and with SMACNA Architectural Sheet Metal Manual.

1. Anchor units of work securely in place by methods indicated, providing for thermal expansion of units; conceal fasteners where possible, and set units true to line and level in locations indicated.
  2. Install work with laps, joints, and seams that will be permanently watertight and weatherproof.
- B. Install work watertight, without waves, warps, buckles, fastening stress, or distortion, allowing for expansion and contraction. Conform to referenced standards. Make metal joints watertight.
  - C. Fastening of metal to walls and wood blocking shall comply with SMACNA Architectural Sheet Metal Manual, Factory Mutual 1-90 wind uplift specifications and/or manufacturer's recommendations whichever is of the highest standard.
  - D. Underlayment: Where sheet metal installation occurs on cementitious or wood substrates, install roofing felt covered with slip sheet direct to substrate, do not allow sheet metal installation directly to concrete or wood.
  - E. Coordinate sheet metal installation with roofing underlayment and air barrier and water-resistive barriers specified in related sections.
  - F. All accessories or other items essential to the completeness of sheet metal installation and water tight envelope of the building, whether specifically indicated or not, shall be provided.
  - G. Flashing: Joints at 10-foot maximum spacing and at 2-1/2-feet from corners. Butt joints with 3/16-inch space centered over matching 8-inch long backing plate with sealer tape in laps.
  - H. Flanged flashings and roof accessories: Set on continuous sealer tape. Nail flanges through sealer tape and at 3-inch maximum spacing.
  - I. Isolate metal from dissimilar metal with 2 coats of specified asphaltic paint, sealer tape or other approved coating, specifically made to stop electrolytic action. Use only stainless steel fasteners to connect isolated dissimilar metals.
  - J. Joints, fastenings, reinforcements and supports: Sized and located as required to preclude distortion or displacement due to thermal expansion and contraction. Conceal fastenings wherever possible.
  - K. Secure flashings in place using concealed fasteners. Use exposed fasteners only where permitted.
  - L. Flexible Flashing Installation: Install at closure flanges, under metal copings, caps and platforms; fully adhered, free of voids, blisters and buckling.
    1. Prime substrates as recommended by flexible flashing manufacturer, allow to dry.
    2. Install flexible flashings in maximum feasible lengths to minimize lap joints.
    3. Peel release paper from roll to expose rubberized asphalt and position flashing to center over joint location before applying. Move along opening or joint, being careful to put flashing as evenly as possible over the opening. Avoid fishmouths.
    4. Press flashing firmly into place and roll using resilient roller with heavy hand pressure. Ensure continuous and intimate contact with substrate.
    5. If wrinkles develop, carefully cut out affected area and replace as outlined above.
    6. Minimize exposure time to that period recommended by the manufacturer.
  - M. Apply plastic cement compound between metal flashings and felt flashings.
  - N. Fit flashings tight in place. Make corners square, surfaces true and straight in planes, and lines accurate to profiles.
  - O. Seal prefinished metal joints watertight.
  - P. Solder other metal joints for full metal surface contact. After soldering, wash metal clean with neutralizing solution and rinse with water.

- Q. Secure gutters and downspouts in place using concealed fasteners.
  - 1. Gutter support straps: Nail or screw into solid framing or blocking, 16 d minimum. Provide straps at 32 inches on center minimum, align with roof framing members where occurs.
  - 2. Gutters: Flash and seal gutters to downspouts and accessories.
  - 3. Leaf guards inside gutter at each downspout or rainwater leader opening.
- R. Slope gutters 1/4 inch per 10 feet, minimum.

### **3.04 OPENING FLASHING**

- A. Flash all wall openings as follows.
  - 1. Install opening flashings after completion of air barriers.
  - 2. Install opening flashings (pre-molded corners and flexible flashings) in accordance with flexible flashing manufacturer's recommendations.
  - 3. Install premolded corner flashings at opening sill corners with nails or screws over layer of flexible flashing extended over face of sheathing and sill opening.
  - 4. Install flexible flashing across face of wall under opening, install additional layer as sill pan with ends turned up 3 inches, coordinate with weather-resistive barrier and jamb flashings to form water-shedding laps. Direct all water flow to exterior of building.
  - 5. Install flexible flashing at head and jamb under weather resistive barrier along opening header, coordinate to lap over sill pan described above, install flexible flashing across head of opening, extended past jamb flashings by 3 inches and secure with nails or screws to wall, fold weather resistive barrier down over head flashing and seal with tape.
  - 6. Flanged Fixtures (Window, Door, Louver, etc.): Set flanges of Head and Jamb in beads of sealant. Do not flash over bottom nailing flange. Do not seal bottom flange.

### **3.05 UTILITY WALL PENETRATION FLASHING INSTALLATION**

- A. Select prefabricated facility services utility penetration flashing sizes and profiles required to suit conditions.
- B. Install in accordance with manufacturer's recommendations, properly lapped with weather resistive barrier and related flashing and finishes to shed water to the building exterior.

### **3.06 FIELD QUALITY CONTROL**

- A. See Section 01 4000 - Quality Requirements, for field inspection requirements.
- B. Inspection will involve surveillance of work during installation to ascertain compliance with specified requirements.
- C. Tolerances
  - 1. Exposed surfaces: Free of dents, scratches, abrasions, or other visible defects; clean, ready for painting.
  - 2. Set flashings and sheet metal to straight, true lines with exposed faces aligned in plane as indicated.

### **3.07 SHOP FABRICATED SHEET METAL**

- A. Installer shall be responsible for determining if the sheet metal systems are in general conformance with roof manufacturer's recommendations.
- B. Metal work shall be shop fabricated to configurations and forms in accordance with recognized sheet metal practices.
- C. Install sheet metal to comply with Architectural Sheet Metal manual, Sheet Metal and Air Conditioning Contractor's National Associations, Inc.
  - 1. Hem exposed edges.

2. Angle bottom edges of exposed vertical surfaces to form drip.
  3. Lap all corners with adjoining pieces, fasten and set in sealant.
- D. Form Joints for continuous strip flashings with a 1/4 inch opening between sections. Cover opening with a cover plate or back with an internal drainage plate formed to the profile of flashing piece. Embed cover plate in mastic, fastened through the opening between the sections and loose locked to the drip edges.

### 3.08 SCHEDULE

- A. Abbreviations:
1. BUR = SBS Modified Membrane Roofing, type(s) specified in related section(s).
- B. 24 ga. Galvanized Steel:
1. Continuous Cleats/Hook Strips
  2. Securement Clips
  3. Siding stops and miscellaneous shapes as indicated.
  4. Stucco/Plaster Stops and miscellaneous shapes as indicated.
  5. Stucco/Plaster Termination Screeds, custom or specially formed types.
  6. BUR Counterflashings
  7. BUR, PVC Sleeper Covers
  8. BUR, PVC Curb Covers
  9. BUR Transition Flashings
  10. BUR Scuppers
  11. BUR, PVC, AS, RT Gutters and Gutter Expansion Joints
  12. BUR, PVC, AS, RT Downspout/Rainwater leader Inlets
- C. 24 ga. Galvalume Steel, Kynar 500 Coated, Color as selected:
1. Coping Caps
  2. BUR, PVC Collector Boxes
- D. 20 ga. Galvanized Steel:
1. Exhaust Fans
  2. Passive Vents
  3. Metal roof gutter.
- E. Stainless Steel:
1. Flashing in contact with aluminum items.
  2. Inlet sleeves at rainwater leaders to prevent contact with gutters of dissimilar metals.
  3. Sill pans at door and window openings.
- F. Lead Flashing:
1. BUR Interior Drain Flashings, Vent Pipe and Conduit Penetrations, 4 lb.
- G. Schedule 40 Steel Pipe:
1. Rainwater leaders, types specified in Section 05 5000.
- H. Types not otherwise scheduled: As recommended by referenced standards for application or condition indicated.

**END OF SECTION**



**SECTION 07 7100**  
**ROOF SPECIALTIES**

**PART 1 GENERAL**

**1.01 SECTION INCLUDES**

- A. Manufactured roof specialties, including copings and roof edge flashings, including reglets.
- B. Pipe Penetration Curbs and Covers.

**1.02 RELATED REQUIREMENTS**

- A. Pertinent Sections specifying Volatile Organic Compound (VOC) Content Restrictions.
- B. Pertinent Sections specifying Roofing and roof substrates.
- C. Section 07 5550 - Modified Bitumen Roofing.
- D. Section 07 6200 - Sheet Metal Flashing and Trim.
- E. Section 07 7200 - Roof Accessories: Manufactured curbs, roof hatches, and snow guards.

**1.03 REFERENCE STANDARDS**

- A. AAMA 2605 - Voluntary Specification, Performance Requirements and Test Procedures for Superior Performing Organic Coatings on Aluminum Extrusions and Panels.
- B. California Code of Regulations, Title 24, Part 11 California Green Building Standards Code, "CAL-Green".
- C. California Code of Regulations, Title 24, Part 2, California Building Code (CBC), International Building Code, with California Amendments.
- D. NRCA ML104 - The NRCA Roofing and Waterproofing Manual; National Roofing Contractors Association.
- E. SMACNA (ASMM) - Architectural Sheet Metal Manual; Sheet Metal and Air Conditioning Contractors' National Association.
- F. SPRI ES-1 - Wind Design Standard for Edge Systems Used with Low Slope Roofing Systems.

**1.04 SUBMITTALS**

- A. See Section 01 3300 - Submittals, for submittal procedures.
- B. Provide complete submittals at the same time as submittals for work in related sections to permit review of complete and integrated systems and assemblies.
- C. Product Data: For each type of product indicated. Include construction details, material descriptions, dimensions of individual components and profiles, and finishes, demonstrate compliance with specified attributes. Provide data on shape of components, materials and finishes, anchor types and locations.
- D. CAL-GREEN Submittals: Product Data - VOC Limits: For adhesives sealants, fillers, primers and coatings, documentation including printed statement of VOC contents, comply with limits specified in related section.

- E. Shop Drawings: Indicate configuration and dimension of components, adjacent construction, required clearances and tolerances, and other affected work. Include isometric details of corner and transition condition.
  - 1. Coping Layout Drawings: Dimension coping in maximum lengths recommended by manufacturer. Indicate butt joints or splices evenly spaced for each run of parapet wall. Balance joints and spaces visually in each run. Dimension equal legs on mitered corner pieces (interior and exterior corners). Request Architect approval of layout in writing on shop drawing.
- F. Samples: Submit two sample, 12 inch in length, illustrating component shape, finish, and color. Submit samples of factory fabricated transitions and intersections.
- G. Manufacturer's Installation Instructions: Indicate special procedures, fasteners, supporting members, and perimeter conditions requiring special attention.
- H. Warranty: Special warranty specified in this Section.
- I. Informational Submittals:
  - 1. Delegated-Design Submittal: For copings and roof edge flashings indicated to comply with performance requirements and design criteria, including analysis data signed and sealed by the qualified professional engineer responsible for their preparation.
  - 2. Professional Engineer Qualifications: Demonstrate compliance with specified requirements.

#### **1.05 QUALITY ASSURANCE**

- A. Professional Engineer Qualifications: A professional engineer who is legally qualified to practice in jurisdiction where Project is located and who is experienced in providing engineering services of the kind indicated. Engineering services are defined as those performed for installations of roof specialties that are similar to those indicated for this Project in material, design, and extent.
- B. Product Options: Information on Drawings and in Specifications establishes requirements for system's aesthetic effects and performance characteristics. Aesthetic effects are indicated by dimensions, arrangements, alignment, and profiles of components and assemblies as they relate to sightlines, to one another, and to adjoining construction. Performance characteristics are indicated by criteria subject to verification by one or more methods including preconstruction testing, field testing, and in-service performance.
  - 1. Do not modify intended aesthetic effects, as judged solely by Architect, except with Architect's approval. If modifications are proposed, submit comprehensive explanatory data to Architect for review.
- C. Perform work in accordance with SMACNA (ASMM) details.
- D. Installer Qualifications: Company specializing in performing the work of this section on projects of similar size and scope and approved by manufacturer.

#### **1.06 COORDINATION**

- A. Coordinate installation of manufactured roof specialties with interfacing and adjoining construction to provide a leakproof, secure, and noncorrosive installation.

#### **1.07 WARRANTY**

- A. Special Warranty on Painted Finishes: Manufacturer's standard form in which manufacturer agrees to repair finish or replace manufactured roof specialties that show evidence of deterioration of factory-applied finishes within specified warranty period.
  - 1. Fluoropolymer Finish: Deterioration includes, but is not limited to, the following:
    - a. Color fading more than 5 Hunter units when tested according to ASTM D 2244.
    - b. Chalking in excess of a No. 8 rating when tested according to ASTM D 4214.

- c. Cracking, checking, peeling, or failure of paint to adhere to bare metal.
2. Verify available warranties for finishes and insert number below. 20-year period is usually available for fluoropolymer finish and is maximum included with manufacturers' published data.
3. Finish Warranty Period: 20 years from date of Substantial Completion.

## **PART 2 PRODUCTS**

### **2.01 PERFORMANCE REQUIREMENTS**

- A. VOC Limits for adhesives sealants, fillers, primers and coatings. Comply with limits specified in related section.
- B. General: Manufacture and install manufactured roof specialties to resist thermally induced movement and exposure to weather without failing, rattling, leaking, or fastener disengagement.
- C. Delegated Design: Design copings and roof edge flashings, including comprehensive engineering analysis by a qualified professional engineer, using performance requirements and design criteria indicated.
- D. Edge Securement: Comply with CBC 1504.5 "Edge Securement for Low-Slope Roofs". Provide products tested for wind resistance in accordance with ANSI/SPRI ES-1, as required by the California Building Code, Chapter 15.
- E. Thermal Movements: Provide manufactured roof specialties that allow for thermal movements resulting from the following maximum change (range) in ambient and surface temperatures by preventing buckling, opening of joints, hole elongation, overstressing of components, failure of joint sealants, failure of connections, and other detrimental effects. Provide clips that resist rotation and avoid shear stress as a result of thermal movements. Base engineering calculation on surface temperatures of materials due to both solar heat gain and nighttime-sky heat loss.
  1. Temperature Change (Range): 120 deg F (67 deg C), ambient; 180 deg F (100 deg C), material surfaces.
- F. Water Infiltration: Provide manufactured roof specialties that do not allow water infiltration to building interior.

### **2.02 COMPONENTS**

- A. Copings: Factory fabricated to sizes required; mitered, welded corners; concealed fasteners.
  1. Configuration: Concealed continuous hold down cleat at both legs; internal splice piece at joints of same material, thickness and finish as cap; concealed stainless steel fasteners.
  2. Mitered, welded corners to have equal dimension legs of manufacturer's minimum recommended length.
  3. Pull-Off Resistance: Tested in accordance with SPRI ES-1 RE-3 to positive and negative design wind pressure as defined by applicable code.
  4. Snap-on Coping Anchor Plates: Concealed, stainless steel sheet, 12 inches (300 mm) wide, 0.028 inch (0.7 mm) thick, with integral cleats.
  5. Face Leg Cleats: Concealed, continuous stainless steel sheet.
  6. Internal Splice Plate with preformed channel, acting as a gutter chair to direct internal drainage to the exterior. Gauge and profile as recommended by manufacturer to suit conditions and loads indicated, stainless steel.
  7. Material: Formed aluminum sheet, 0.050 inch thick, minimum.
  8. Finish: Three coat 70 percent polyvinylidene fluoride.
  9. Color: To be selected by Architect from manufacturer's standard range.
  10. Manufacturers:
    - a. The Garland Company, [www.garlandco.com](http://www.garlandco.com), 415 971 2739.

- c. Substitutions: See Section 01 6000 - Product Requirements.
- B. Counterflashings and Reglets:
1. Counterflashings: Manufactured units in lengths not exceeding 12 feet (3.6 m) designed to snap into reglets and compress against base flashings with joints lapped, from the following exposed metal in thickness indicated:
    - a. Stainless Steel: 0.025 inch (0.64 mm) thick, No. 4 (bright, polished directional satin).
  2. Reglets: Units of type, material, and profile indicated, formed to provide secure interlocking of separate reglet and counterflashing pieces and compatible with flashing indicated with factory-mitered and -welded corners and junctions. Manufactured units formed to provide secure interlocking of separate reglet and counterflashing pieces, and compatible with flashings indicated, from the following exposed metal in thickness indicated:
    - a. Stainless Steel: 0.025 inch (0.64 mm) thick, No. 4 (bright, polished directional satin).
    - b. For stucco application, with upturned fastening flange and extension leg of length to match thickness of applied finish materials.
    - c. For concrete application with temporary closure tape to keep reglet free of concrete materials, special fasteners for attaching reglet to concrete forms, and guides to ensure alignment of reglet section ends.
  3. Accessories:
    - a. Flexible-Flashing Retainer: Provide resilient plastic or rubber accessory to secure flexible flashing in reglet where clearance does not permit use of standard metal counterflashing or where Drawings show reglet without metal counterflashing.
    - b. Counterflashing Wind-Restraint Clips: Provide clips to be installed before counterflashing to prevent wind uplift of counterflashing lower edge.
  4. Products:
    - a. Cheney Flashing Company, Inc.: [www.cheneyflashing.com](http://www.cheneyflashing.com).
    - b. Fry Reglet Corporation: [www.fryreglet.com](http://www.fryreglet.com).
    - c. Hickman, W. P. Company: [www.wph.com](http://www.wph.com).
    - d. Substitutions: See Section 01 6000 - Product Requirements.
- C. Pipe Penetration Curbs: Pipe Penetration Curbs and Covers, locate at grouped pipe penetrations serving mechanical unit locations. Size as recommended by manufacturer to accommodate piping indicated and to minimize number of curb penetrations required. Field located to avoid conflicts with other systems.
1. Finish: Field Painted.
  2. Insulated Curb for Non-Insulated Roof Decks: Fully mitered 3 inch cant, welded 18 gauge galvanized steel shell and base plate, 1-1/2 inch thick 3-pound density rigid insulation, factory installed 2 x 2 wood nailer, reinforcing on sides 36 inches and greater.
    - a. ThyCurb Model TC-2.
  3. Graduated Pipe Boot Cover: ABS thermoplastic korad acrylic cover, graduated boots molded of weather-resistant Plastisol and (2) stainless steel pipe clamps per boot.
    - a. ThyCurb Model TCC-5.
  4. Manufacturer:
    - a. Thybar Corp/ThyCurb: [www.thybar.com](http://www.thybar.com).
    - b. Substitutions: See Section 01 6000 - Product Requirements.

## 2.03 ACCESSORIES

- A. Fasteners, separators, sealants, and other miscellaneous items as recommended by required to complete manufactured roof specialty systems.
- B. Sealants: Silicone types as specified in Section 07 9200.

- C. Roof Cement and related materials as required for installation with products specified in related sections.

## **2.04 FINISHES**

- A. PVDF (Polyvinylidene Fluoride) Coating: Superior Performance Organic Finish, AAMA 2605; multiple coat, thermally cured fluoropolymer finish system; color as scheduled.

## **PART 3 EXECUTION**

### **3.01 EXAMINATION**

- A. Verify that deck, curbs, roof membrane, base flashing, and other items affecting work of this Section are in place and positioned correctly.

### **3.02 INSTALLATION**

- A. Anchor manufactured roof specialties securely in place and capable of resisting forces specified in performance requirements. Use fasteners, separators, sealants, and other miscellaneous items as required to complete manufactured roof specialty systems.
  - 1. Install manufactured roof specialties with provisions for thermal and structural movement.
  - 2. Torch cutting of manufactured roof specialties is not permitted.
- B. Install components in accordance with manufacturer's instructions.
- C. Conform to SMACNA (ASMM) drawing details as noted:
- D. Metal Protection: Where dissimilar metals will contact each other or corrosive substrates, protect against galvanic action by painting contact surfaces with bituminous coating or by other permanent separation as recommended by manufacturer.
  - 1. Coat concealed side of manufactured roof specialties with bituminous coating where in contact with wood, ferrous metal, or cementitious construction.
  - 2. Underlayment: Where installing exposed-to-view components of manufactured roof specialties directly on cementitious or wood substrates, install a course of felt underlayment and cover with a slip sheet, or install a course of polyethylene underlayment.
- E. Coordinate installation of components of this section with installation of roofing membrane and base flashings.
- F. Coordinate installation of sealants and roofing cement with work of this section to ensure water tightness.
- G. Install manufactured roof specialties level, plumb, true to line and elevation, and without warping, jogs in alignment, excessive oil-canning, buckling, or tool marks.
- H. Install manufactured roof specialties to fit substrates and to result in watertight performance. Verify shapes and dimensions of surfaces to be covered before manufacture.
- I. Coordinate installation of flashing flanges into reglets .
- J. Align work plumb and level , flush with adjacent surfaces.
- K. Rigidly anchor to substrate to prevent misalignment.

### **3.03 COPING INSTALLATION**

- A. Layout: Provide coping in maximum lengths recommended by manufacturer. Space butt joints or splices evenly for each run of parapet wall. Balance joints and spaces visually in each run.
- B. Install cleats, anchor plates, and other anchoring and attachment accessories and devices with concealed fasteners.

- C. Coordinate with roof membrane and exterior cladding air barrier installation to ensure continuity and membrane seal across top of parapet wall.
- D. Anchor copings to resist uplift and outward forces according to performance requirements.
  - 1. Interlock face and back leg drip edges of snap-on coping cap into cleated anchor plates anchored to substrate at manufacturer's recommended spacing.

#### **3.04 COUNTERFLASHING AND REGLET INSTALLATION**

- A. Counterflashings: Coordinate installation of counterflashings with installation of base flashings. Insert counterflashings in reglets or receivers and fit tightly to base flashings. Extend counterflashings 4 inches over base flashings. Lap counterflashing joints a minimum of 4 inches and bed with elastomeric sealant.

#### **3.05 CLEANING AND PROTECTION**

- A. Remove temporary protective coverings and strippable films as manufactured roof specialties are installed. On completion of installation, clean finished surfaces, including removing unused fasteners, metal filings, pop rivet stems, and pieces of flashing. Maintain in a clean condition during construction.
- B. Replace manufactured roof specialties that have been damaged or that cannot be successfully repaired by finish touchup or similar minor repair procedures.

**END OF SECTION**

**SECTION 07 7200**  
**ROOF ACCESSORIES**

**PART 1 GENERAL**

**1.01 SECTION INCLUDES**

- A. Curbs.
- B. Equipment rails.
- C. Roof hatches.
- D. Non-penetrating pedestals.
- E. Roof hatch safety railing system.
- F. Rooftop support devices for pipes, conduits and ducts.

**1.02 RELATED REQUIREMENTS**

- A. Pertinent Sections specifying Volatile Organic Compound (VOC) Content Restrictions.
- B. Section 06 1000 - Rough Carpentry: Wood curbs at deck penetrations.
- C. Pertinent Sections specifying Roofing and roof substrates.
- D. Section 07 6200 - Sheet Metal Flashing and Trim: Roof accessory items fabricated from sheet metal.
- E. Section 07 7100 - Roof Specialties: Other manufactured roof items.

**1.03 REFERENCE STANDARDS**

- A. 29 CFR 1910.23 - Guarding floor and wall openings and holes; current edition.
- B. ASTM A123/A123M - Standard Specification for Zinc (Hot-Dip Galvanized) Coatings on Iron and Steel Products; 2015.
- C. ASTM A153/A153M - Standard Specification for Zinc Coating (Hot-Dip) on Iron and Steel Hardware; 2009.
- D. ASTM B221 - Standard Specification for Aluminum and Aluminum-Alloy Extruded Bars, Rods, Wire, Profiles, and Tubes; 2014.
- E. ASTM B221M - Standard Specification for Aluminum and Aluminum-Alloy Extruded Bars, Rods, Wire, Profiles, and Tubes [Metric]; 2013.
- F. California Code of Regulations, Title 24, Part 11 California Green Building Standards Code, "CAL-Green".
- G. California Code of Regulations, Title 24, Part 2, California Building Code (CBC), International Building Code, with California Amendments.
- H. MSS SP-58 - Pipe Hangers and Supports - Materials, Design, Manufacture, Selection, Application, and Installation; 2009.

**1.04 SUBMITTALS**

- A. General: Submit in accordance with Section 01 3300.

- B. Provide complete submittals at the same time as submittals for work in related sections to permit review of complete and integrated systems and assemblies.
- C. Product Data: Manufacturer's data sheets on each product to be used.
  - 1. Preparation instructions and recommendations.
  - 2. Storage and handling requirements and recommendations.
  - 3. Installation methods.
  - 4. Maintenance requirements.
- D. CAL-GREEN Submittals: Product Data – VOC Limits: For adhesives sealants, fillers, primers and coatings, documentation including printed statement of VOC contents, comply with limits specified in related section.
- E. Shop Drawings: Submit detailed layout developed for this project and provide dimensioned location and number for each type of roof accessory.

#### **1.05 DELIVERY, STORAGE, AND HANDLING**

- A. Store products in manufacturer's unopened packaging until ready for installation.
- B. Store products under cover and elevated above grade.

#### **1.06 WARRANTY**

- A. Provide Manufacturer's full system material warranty necessary to cover all cost of repairs and/or replacement of all components of the system against defects in manufacturing for the same period and duration as specified in Division 7 roofing warranty. Warranty will not include Acts of God, vandalism, neglect, or improper spacing or installation of equipment.

#### **1.07 PROJECT CONDITIONS**

- A. Verify that other trades with related work are complete before installing roof accessories. Coordinate installation with roof membrane and roof insulation manufacturer's instructions.
- B. Mounting surfaces shall be straight and secure; substrates shall be of proper width.
- C. Coordinate layout and installation of roof accessories with interfacing and adjoining construction to provide a leak-proof, weather-tight, secure, and non-corrosive installation.
  - 1. With Architect's written approval, adjust location of roof accessories that would interrupt roof drainage routes.

### **PART 2 PRODUCTS**

#### **2.01 PERFORMANCE REQUIREMENTS**

- A. VOC Limits for adhesives sealants, fillers, primers and coatings. Comply with limits specified in related section.
- B. NO WOOD SLEEPERS will be allowed. Pipe supports in this Section shall be used where ever wood blocking/sleepers are indicated or where piping supports are required by code.

#### **2.02 ROOF CURBS**

- A. Roof Curbs Mounting Assemblies: Factory fabricated hollow sheet metal construction, internally reinforced, and capable of supporting superimposed live and dead loads and designated equipment load with fully mitered and sealed corner joints welded or mechanically fastened, and integral counterflashing with top and edges formed to shed water.
  - 1. Roof Curb Mounting Substrate: Curb substrate consists of standing seam metal roof panel system.



2. Sheet Metal Material:
    - a. Aluminum: 0.080 inch (2.03 mm) minimum thickness, with 3003 alloy, and H14 temper.
  3. Roofing Cants: Provide integral sheet metal roofing cants dimensioned to begin slope at top of roofing system at 1:1 slope; minimum cant height 4 inches (102 mm).
  4. Fabricate curb bottom and mounting flanges for installation directly on metal roof panel system to match slope and configuration of system.
    - a. Extend side flange to next adjacent roof panel seam and comply with seam configurations and seal connection, providing at least 6 inch (152 mm) clearance between curb and metal roof panel flange allowing water to properly flow past curb.
    - b. Where side of curb aligns with metal roof panel flange, attach fasteners on upper slope of flange to curb connection allowing water to flow past below fasteners, and seal connection.
    - c. Maintain at least 12 inch (305 mm) clearance from curb, and lap upper curb flange on underside of down sloping metal roof panel, and seal connection.
    - d. Lap lower curb flange overtop of down sloping metal roof panel and seal connection.
  5. Provide layouts and configurations indicated on drawings.
- B. Curbs Adjacent to Roof Openings: Provide curb on each side of opening, with top of curb horizontal for equipment mounting.
1. Provide preservative treated wood nailers along top of curb.
  2. Insulate inside curbs with 1-1/2 inch (38 mm) thick fiberglass insulation.
- C. Equipment Rail Curbs: Straight curbs on each side of equipment, with top of curbs horizontal and level with each other for equipment mounting.

### 2.03 ROOF HATCHES AND VENTS

- A. Roof Hatch Manufacturers:
1. Activar Construction Products Group - JL Industries; RHDA Aluminum Diamond Series™ Roof Hatch or RHG-STH - RHG Series Roof Hatches With Safety Railing: [www.activarcpg.com/#sle](http://www.activarcpg.com/#sle).
  2. Babcock-Davis: [www.babcockdavis.com/#sle](http://www.babcockdavis.com/#sle).
  3. Bilco Company; Type E (ladder access, 3 ft square, solid cover): [www.bilco.com/#sle](http://www.bilco.com/#sle).
  4. Nystrom, Inc: [www.nystrom.com/#sle](http://www.nystrom.com/#sle).
  5. Substitutions: See Section 01 6000 - Product Requirements.
- B. Frames and Curbs: One-piece curb and frame with integral cap flashing to receive roof flashings; extended bottom flange to suit mounting.
1. Insulation: Manufacturer's standard; 1 inch (25 mm) rigid glass fiber, located on outside face of curb.
  2. Curb Height: As required to maintain 8 inches vertical flashing leg above surface of roof membrane.
  3. Curb Height: 12 inches (305 mm) from finished surface of roof, minimum.
- C. Metal Covers: Flush, insulated, hollow metal construction.
1. Capable of supporting 40 psf (1.92 kPa) live load.
  2. Insulation: Manufacturer's standard 1 inch (25 mm) rigid glass fiber.
  3. Gasket: Neoprene, continuous around cover perimeter.
- D. Safety Railing System: Manufacturer's standard accessory safety rail system mounted directly to curb.
1. Comply with 29 CFR 1910.23, with a safety factor of two.
  2. Posts and Rails: Galvanized Steel or Aluminum.

3. Gate: Same material as railing; automatic closing with latch.
  4. Finish: Manufacturer's standard, factory applied finish.
  5. Gate Hinges and Post Guides: ASTM B221 (ASTM B221M), 6063 alloy, T5 temper aluminum.
  6. Mounting Brackets: Hot dipped galvanized steel, 1/4 inch (6.4 mm) thick, minimum.
  7. Fasteners: Stainless steel, Type 316.
  8. Manufacturers:
    - a. Same as hatch manufacturer, or as approved by hatch manufacturer in writing.
- E. Hardware: Steel, zinc coated and chromate sealed, unless otherwise indicated or required by manufacturer.
1. Lifting Mechanisms: Compression or torsion spring operator with shock absorbers that automatically opens upon release of latch; capable of lifting covers despite 10 psf (475 kPa) load.
  2. Hinges: Heavy duty pintle type.
  3. Hold open arm with vinyl-coated handle for manual release.
  4. Latch: Upon closing, engage latch automatically and reset manual release.
  5. Manual Release: Pull handle on interior.
  6. Locking: Padlock hasp on interior.

#### **2.04 NON-PENETRATING ROOFTOP SUPPORTS/ASSEMBLIES**

- A. Non-Penetrating Rooftop Support/Assemblies: Manufacturer-engineered and factory-fabricated, with pedestal bases that rest on top of roofing membrane, and not requiring any attachment to roof structure and not penetrating roofing assembly.
1. Design Loadings and Configurations: As required by applicable codes.
  2. Height: Provide minimum clearance of 6 inches (152 mm) under supported items to top of roofing.
  3. Support Spacing and Base Sizes: As required to distribute load sufficiently to prevent indentation of roofing assembly.
  4. Steel Components: Stainless steel, or carbon steel hot-dip galvanized after fabrication in accordance with ASTM A123/A123M.
  5. Resilient Components: Molded 100 percent recycled rubber or HDPE plastic.
  6. Hardware, Bolts, Nuts, and Washers: Stainless steel, or carbon steel hot-dip galvanized after fabrication in accordance with ASTM A153/A153M.
  7. Manufacturers:
    - a. PHP Systems/Design: [www.phpsd.com](http://www.phpsd.com).
    - b. RoofTop Accessories: [www.keycurb.com](http://www.keycurb.com).
    - c. Substitutions: See Section 01 6000 - Product Requirements.
- B. Pipe Supports: Provide resilient base pipe curb attachment fixtures complying with MSS SP-58 and as indicated. If no supports are shown, provide types necessary to support items indicated, in compliance with referenced standard, to suit conditions shown.
1. Attachment/Support Fixtures: As recommended by manufacturer, same type as indicated for equivalent indoor hangers and supports; corrosion resistant material.
  2. Provide vibration isolation and cushioning with minimum shock transmission to the substrate, allowing free movement, free of pipe tension or binding.
  3. See relevant piping system specification section for additional requirements.
- C. Duct Supports: KeyCurb Adjustable Support Model (AS). Supports piping and HVAC ducts. Two (2) KeyCurbs Model KS with cross bar to suspend hangers or adjustable rollers placed on top of cross bar.
- D. Conduit and Cable Tray Supports:

1. Type: KeyCurb Strut, Model (KS) Curb with a framing channel for strut clamps .
  2. Type: KeyCurb Strut Adjustable, Model (KSA) Curb with a framing channel and adjustable threaded rods for strut clamps.
- E. Non-Penetrating Pedestals: Steel pedestals with square, round, or rectangular bases.
1. Bases: High density polypropylene or recycled rubber.
  2. Base Sizes: As required to distribute load sufficiently to prevent indentation of roofing assembly.
  3. Steel Components: Stainless steel, or carbon steel hot-dip galvanized after fabrication in accordance with ASTM A123/A123M.
  4. Resilient Components: Molded 100 percent recycled rubber or HDPE plastic.

## **2.05 ACCESSORIES**

- A. Fasteners: Same metal as metals being fastened, or nonmagnetic stainless steel or other noncorrosive metal as recommended by manufacturer. Match finish of exposed fasteners with finish of material being fastened.
1. Where removing exterior exposed fasteners affords access to building, provide nonremovable fastener heads.

## **PART 3 EXECUTION**

### **3.01 EXAMINATION**

- A. Do not begin installation until substrates have been properly prepared.
- B. If substrate preparation is the responsibility of another installer, notify Architect of unsatisfactory preparation before proceeding.

### **3.02 PREPARATION**

- A. Clean surfaces thoroughly prior to installation.
- B. Prepare surfaces using methods recommended by manufacturer for achieving acceptable results for applicable substrate under project conditions.

### **3.03 INSTALLATION**

- A. Install in accordance with manufacturer's instructions, in manner that maintains roofing system weather-tight integrity.
- B. Separation: Separate metal from incompatible metal or corrosive substrates, including wood, by coating concealed surfaces, at locations of contact, with bituminous coating or providing other permanent separation.
- C. Cap Flashing: Where required as component of accessory, install cap flashing to provide waterproof overlap with roofing or roof flashing (as counter-flashing). Seal overlap with thick bead of mastic sealant approved for application by roof manufacturer.
- D. Operational Units: Test-operate units with operable components. Clean and lubricate joints and hardware. Adjust for proper operation.

### **3.04 PIPE SUPPORTS**

- A. Provide support for pipe routing as laid out in field.
- B. Set bases and support framing in locations specified or as required by site conditions but not to exceed 10'-0" spacing. Apply slip sheet or pad if required by roofing manufacturer.

- C. Adjust all frame structures to required height and weight, assemble framing, supports, and hangers to configuration indicated.
- D. Adjust each required hanger, roller or clamp to its desired height, check each support for equal weight dispersal.

**3.05 CLEANING**

- A. Clean installed work to like-new condition.

**3.06 PROTECTION**

- A. Protect installed products until completion of project.
- B. Touch-up, repair or replace damaged products before Date of Substantial Completion.

**END OF SECTION**

**SECTION 07 8400**  
**FIRESTOPPING**

**PART 1 GENERAL**

**1.01 SECTION INCLUDES**

- A. Firestopping systems.
- B. Firestopping of all joints and penetrations in fire resistance rated and smoke resistant assemblies, whether indicated on drawings or not, and other openings indicated.

**1.02 RELATED SECTIONS**

- A. Section 01 6116 - Volatile Organic Compound (VOC) Content Restrictions.
- B. Section 01 7000 - Execution and Closeout Requirements: Cutting and patching.
- C. Section 09 2116 - Gypsum Board Assemblies: Gypsum wallboard fireproofing.
- D. Pertinent sections of other Divisions specifying work penetrating rated assemblies which require firestopping.

**1.03 REFERENCE STANDARDS**

- A. ASTM E119 - Standard Test Methods for Fire Tests of Building Construction and Materials; 2015.
- B. ASTM E814 - Standard Test Method for Fire Tests of Through-Penetration Fire Stops; 2013a.
- C. ASTM E1966 - Standard Test Method for Fire Resistive Joint Systems; 2007 (Reapproved 2011).
- D. ASTM E2174 - Standard Practice for On-Site Inspection of Installed Firestops; 2014.
- E. ASTM E2393 - Standard Practice for On-Site Inspection of Installed Fire Resistive Joint Systems and Perimeter Fire Barriers; 2010a.
- F. ASTM E2307 - Standard Test Method for Determining Fire Resistance of Perimeter Fire Barriers Using Intermediate-Scale, Multi-story Test Apparatus; 2015a.
- G. ASTM E2837 - Standard Test Method for Determining the Fire Resistance of Continuity Head-of-Wall Joint Systems Installed Between Rated Wall Assemblies and Nonrated Horizontal Assemblies; 2013.
- H. ASTM G21 - Standard Practice for Determining Resistance of Synthetic Polymeric Materials to Fungi; 2015.
- I. ITS (DIR) - Directory of Listed Products; current edition.
- J. FM 4991 - Approval Standard for Firestop Contractors; 2013.
- K. FM (AG) - FM Approval Guide; current edition.
- L. ASTM C 518
- M. Manufacturer's recommendations for installation.
- N. SCAQMD 1168 - South Coast Air Quality Management District Rule No.1168; current edition.
- O. UL 2079 - Standard for Tests for Fire Resistance of Building Joint Systems; Current Edition, Including All Revisions.

- P. UL (DIR) - Online Certifications Directory; current listings at database.ul.com.
- Q. UL (FRD) - Fire Resistance Directory; current edition.

#### **1.04 SUBMITTALS**

- A. See Section 01 3300 - Submittals, for submittal procedures.
- B. Schedule of Firestopping: List each type of penetration, fire rating of the penetrated assembly, firestopping test or design number, and certification that material is classified or listed for the type and size of void to be firestopped.
- C. Product Data: Provide data on product characteristics.
- D. Sustainable Design Submittal: Submit VOC content documentation for all non-preformed materials.
- E. Sketches indicating proposed methods of installation where not detailed on the Drawings.
- F. Manufacturer's Installation Instructions: Indicate preparation and installation instructions.
- G. Proof of applicator qualifications.
- H. Manufacturer's Certificate: Certify that products meet or exceed specified requirements.
- I. Certificate from authority having jurisdiction indicating approval of materials used.
- J. Installer Qualification: Submit qualification statements for installing mechanics.

#### **1.05 QUALITY ASSURANCE**

- A. Fire Testing: Provide firestopping assemblies of designs that provide the scheduled fire ratings when tested in accordance with methods indicated.
  - 1. Listing in UL (FRD), FM (AG), or ITS (DIR) will be considered as constituting an acceptable test report.
  - 2. Valid evaluation report published by ICC Evaluation Service, Inc. (ICC-ES) at [www.icc-es.org](http://www.icc-es.org) will be considered as constituting an acceptable test report.
  - 3. Submission of actual test reports is required for assemblies for which none of the above substantiation exists.
- B. Manufacturer Qualifications: Company specializing in manufacturing the products specified in this section with minimum three years documented experience.
- C. Deliver materials in the original packages bearing the manufacturer's label showing classification or listing.
- D. Installer Qualifications: Company specializing in performing the work of this section with minimum three years experience and approved by the manufacturer.
  - 1. Trained by manufacturer.
  - 2. Approved by Factory Mutual Research Corporation under FM 4991, or meeting any two of the following requirements:
  - 3. Verification of minimum three years documented experience installing work of this type.
  - 4. Verification of at least five satisfactorily completed projects of comparable size and type.
  - 5. Licensed by local authorities having jurisdiction (AHJ).

## 1.06 FIELD CONDITIONS

- A. Comply with firestopping manufacturer's recommendations for temperature and conditions during and after installation; maintain minimum temperature before, during, and for three days after installation of materials.
- B. Provide ventilation in areas where solvent-cured materials are being installed.

## PART 2 PRODUCTS

### 2.01 MANUFACTURERS

- A. Firestopping Manufacturers:
  - 1. 3M Fire Protection Products: [www.3m.com/firestop](http://www.3m.com/firestop).
  - 2. A/D Fire Protection Systems Inc: [www.adfire.com](http://www.adfire.com).
  - 3. Hilti, Inc. : [www.us.hilti.com](http://www.us.hilti.com).
  - 4. Substitutions: See Section 01 6000 - Product Requirements.

### 2.02 MATERIALS

- A. Volatile Organic Compound (VOC) Content: Provide products having VOC content lower than that required by SCAQMD 1168.
- B. Mold and Mildew Resistance: Provide firestopping materials with mold and mildew resistance rating of zero(0) in accordance with ASTM G21.
- C. Primers, Sleeves, Forms, Insulation, Packing, Stuffing, and Accessories: Provide type of materials as required for tested firestopping assembly.
- D. Fire Ratings: Refer to drawings for required systems and ratings.

### 2.03 FIRESTOPPING ASSEMBLY REQUIREMENTS

- A. Perimeter Fire Containment Firestopping: Use system that has been tested according to ASTM E2307 to have fire resistance F Rating equal to required fire rating of floor assembly.
  - 1. Movement: Provide systems that have been tested to show movement capability as indicated.
  - 2. Temperature Rise: Provide systems that have been tested to show T Rating as indicated.
  - 3. Air Leakage: Provide systems that have been tested to show L Rating as indicated.
  - 4. Where floor assembly is not required to have a fire rating, provide systems that have been tested to show L Rating as indicated.
- B. Head-of-Wall Joint System Firestopping at Joints Between Fire-Rated Wall Assemblies and Non-Rated Horizontal Assemblies: Use system that has been tested according to ASTM E2837 to have fire resistance F Rating equal to required fire rating of floor or wall, whichever is greater.
  - 1. Movement: Provide systems that have been tested to show movement capability as indicated.
- C. Floor-to-Floor, Wall-to-Wall, and Wall-to-Floor Joints, Except Perimeter, Where Both Are Fire-Rated: Use system that has been tested according to ASTM E1966 or UL 2079 to have fire resistance F Rating equal to required fire rating of the assembly in which the joint occurs.
  - 1. Movement: Provide systems that have been tested to show movement capability as indicated.
  - 2. Air Leakage: Provide systems that have been tested to show L Rating as indicated.
  - 3. Watertightness: Provide systems that have been tested to show W Rating as indicated.

4. Listing by FM (AG), ITS (DIR), UL (DIR), or UL (FRD) in their certification directories will be considered evidence of successful testing.
- D. Through Penetration Firestopping: Use system that has been tested according to ASTM E814 to have fire resistance F Rating equal to required fire rating of penetrated assembly.
1. Temperature Rise: Provide systems that have been tested to show T Rating as indicated.
  2. Air Leakage: Provide systems that have been tested to show L Rating as indicated.
  3. Watertightness: Provide systems that have been tested to show W Rating as indicated.
  4. Listing by FM (AG), ITS (DIR), UL (DIR), or UL (FRD) in their certification directories will be considered evidence of successful testing.

## **2.04 FIRESTOPPING SYSTEMS**

- A. Firestopping:
1. As required by the proprietary U.L. or Warnock Hersey classification noted on the Drawings.
  2. If not specified by the classification, listed materials as specified in this section.
  3. Fire Ratings: See drawings for required systems and ratings.

## **2.05 MATERIALS**

- A. All materials Underwriters Laboratories Inc. (UL) or Warnock Hersey classified or listed as required to meet the appropriate firestop application.
- B. High-melt-point mineral wool or ceramic fiber, unfaced; Master Products "FireMaster Bulk".
1. ASTM E84: Flame Spread 0; Smoke Development 0; Fuel Contributed 0.
  2. Non-combustible in accordance with ASTM E136.
- C. Gypsum board firestopping: ASTM C 36, Type X.
- D. Sealant, Fire-Retardant: 3M "Fire Dam 150", Dow Corning "Firestop" 2000", Hilti, Inc. "FS One", or approved equal for required fire rating. Color as selected by Architect from manufacturer's standards.
- E. Calcium silicate board: Promadeck as manufactured by Promat Fire Protection division of Eternit, Blandon, PA.; thickness as noted on the Drawings or as required by the tested assembly.
- F. Primers, Sleeves, Forms, Insulation, Packing, Stuffing, and Accessories: Type required for tested assembly design.
- G. Installation Accessories: Clips, collars, fasteners, temporary stops or dams, and other devices required to position and retain materials in place.
- H. Marking and Identification Tape: Pre-printed self-adhesive vinyl signage identifying fire and smoke assemblies, complying with CBC 703.7, designed to adhere to gypsum board surfaces. M&I Tape; Wege & Company, San Jose CA, [www.wege.us.com](http://www.wege.us.com).

## **PART 3 EXECUTION**

### **3.01 EXAMINATION**

- A. Verify openings are ready to receive the work of this section.

### **3.02 PREPARATION**

- A. Clean substrate surfaces of dirt, dust, grease, oil, loose material, or other materials that could adversely affect bond of firestopping material.
- B. Remove incompatible materials that could adversely affect bond.



- C. Install backing or damming materials to arrest liquid material leakage.

**3.03 INSTALLATION**

- A. Install materials in manner described in fire test report and in accordance with manufacturer's instructions, achieving installation of required rating, completely closing openings.
- B. Do not cover installed firestopping until inspected by authorities having jurisdiction.
- C. Install labeling required by code.
  - 1. Self-adhesive vinyl tape with identification of assembly as required by CBC 703.7.

**3.04 FIELD QUALITY CONTROL**

- A. Independent Testing Agency: Inspection agency employed and paid by Owner, will examine penetration firestopping in accordance with ASTM E2174, and ASTM E2393.
- B. Repair or replace penetration firestopping and joints at locations where inspection results indicate firestopping or joints do not meet specified requirements.

**3.05 CLEANING**

- A. Clean adjacent surfaces of firestopping materials.

**3.06 PROTECTION**

- A. Protect adjacent surfaces from damage by material installation.

**END OF SECTION**

**SECTION 07 9200**  
**JOINT SEALANTS**

**PART 1 GENERAL**

**1.01 SECTION INCLUDES**

- A. Nonsag gunnable joint sealants.
- B. Self-leveling pourable joint sealants.
- C. Joint backings and accessories.

**1.02 RELATED REQUIREMENTS**

- A. Section 01 6116 - Volatile Organic Compound (VOC) Content Restrictions: Additional requirements for sealants and primers.
- B. Pertinent Sections specifying sealants or referencing this Section for sealant products and execution requirements.

**1.03 REFERENCE STANDARDS**

- A. ASTM C661 - Standard Test Method for Indentation Hardness of Elastomeric-Type Sealants by Means of a Durometer; 2006 (Reapproved 2011).
- B. ASTM C794 - Standard Test Method for Adhesion-In-Peel of Elastomeric Joint Sealants; 2015.
- C. ASTM C834 - Standard Specification for Latex Sealants; 2014.
- D. ASTM C919 - Standard Practice for Use of Sealants in Acoustical Applications; 2012.
- E. ASTM C920 - Standard Specification for Elastomeric Joint Sealants; 2014.
- F. ASTM C1087 - Standard Test Method for Determining Compatibility of Liquid-Applied Sealants with Accessories Used in Structural Glazing Systems; 2000 (Reapproved 2011).
- G. ASTM C1193 - Standard Guide for Use of Joint Sealants; 2013.
- H. ASTM C1248 - Standard Test Method for Staining of Porous Substrate by Joint Sealants; 2008 (Reapproved 2012).
- I. ASTM C1311 - Standard Specification for Solvent Release Sealants; 2014.
- J. ASTM C1521 - Standard Practice for Evaluating Adhesion of Installed Weatherproofing Sealant Joints; 2013.
- K. ASTM D2240 - Standard Test Method for Rubber Property--Durometer Hardness; 2005 (Reapproved 2010).
- L. California Code of Regulations, Title 24, Part 11 California Green Building Standards Code, "CAL-Green".
- M. Manufacturer's recommendations and specifications.
- N. SWRI (VAL) - SWR Institute Validated Products Directory; Current Listings at [www.swrionline.org](http://www.swrionline.org).

**1.04 SUBMITTALS**

- A. See Section 01 3300 - Administrative Requirements, for submittal procedures.

- B. Product Data for Sealants: Submit manufacturer's technical data sheets for each product to be used, that includes the following.
  - 1. Physical characteristics, including movement capability, VOC content, hardness, cure time, and color availability.
  - 2. List of backing materials approved for use with the specific product.
  - 3. Substrates that product is known to satisfactorily adhere to and with which it is compatible.
  - 4. Substrates the product should not be used on.
  - 5. Substrates for which use of primer is required.
  - 6. Substrates for which laboratory adhesion and/or compatibility testing is required.
  - 7. Installation instructions, including precautions, limitations, and recommended backing materials and tools.
  - 8. Sample product warranty.
  - 9. Certification by manufacturer indicating that product complies with specification requirements.
  - 10. SWRI Validation: Provide currently available sealant product validations as listed by SWRI (VAL) for specified sealants.
- C. Product Data for Accessory Products: Submit manufacturer's technical data sheet for each product to be used, including physical characteristics, installation instructions, and recommended tools.
  - 1. Manufacturer's Installation Instructions: Indicate limitations, special procedures, surface preparation, and perimeter conditions requiring special attention.
  - 2. Sealant, Waterproofing, and Restoration Institute (SWRI) Validation Certificate: For each sealant specified to be validated by SWRI's Sealant Validation Program.
- D. Joint-Sealant Schedule: Include the following information:
  - 1. Joint-sealant application, joint location, and designation.
  - 2. Joint-sealant manufacturer and product name.
  - 3. Joint-sealant formulation.
  - 4. Joint-sealant colors (multiple colors will be required).
- E. Preconstruction Compatibility and Adhesion Test Reports: From sealant manufacturer, indicating the following:
  - 1. Materials forming joint substrates and joint-sealant backings have been tested for compatibility and adhesion with joint sealants.
  - 2. Interpretation of test results and written recommendations for primers and substrate preparation needed for adhesion.
- F. Color Cards for Selection: Where sealant color is not specified, submit manufacturer's color cards showing standard colors available for selection.
- G. Samples for Verification: Where custom sealant color is specified, obtain directions from Architect and submit at least two physical samples for verification of color of each required sealant.
- H. Sustainable Design Documentation: For sealants and primers, submit VOC content and emissions documentation as specified in Section 01 6116.
- I. Manufacturer Qualifications. Demonstrate compliance with specified requirements.
- J. Installer Qualifications. Demonstrate compliance with specified requirements.
- K. Preconstruction Laboratory Test Reports: Submit at least four weeks prior to start of installation.

- L. Installation Plan: Submit at least four weeks prior to start of installation.
- M. Preinstallation Field Adhesion Test Plan: Submit at least two weeks prior to start of installation.
- N. Field Quality Control Plan: Submit at least two weeks prior to start of installation.
- O. Preinstallation Field Adhesion Test Reports: Submit filled out Preinstallation Field Adhesion Test Reports log within 10 days after completion of tests; include bagged test samples and photographic records.
- P. Installation Log: Submit filled out log for each length or instance of sealant installed.
- Q. Field Quality Control Log: Submit filled out log for each length or instance of sealant installed, within 10 days after completion of inspections/tests; include bagged test samples and photographic records, if any.

#### 1.05 QUALITY ASSURANCE

- A. Manufacturer Qualifications: Company specializing in manufacturing the products specified in this section with minimum three years documented experience.
- B. Installer Qualifications: Company specializing in performing the work of this section and with at least three years of documented experience.
- C. Testing Agency Qualifications: Independent firm specializing in performing testing and inspections of the type specified in this section.
- D. Manufacturer of sealant and caulking material to certify that cleaners, joint filler or bond breakers, and primers, for a particular application, are compatible with sealant.
- E. Preconstruction Laboratory Testing: Arrange for sealant manufacturer(s) to test each combination of sealant, substrate, backing, and accessories.
  - 1. Adhesion Testing: In accordance with ASTM C794.
  - 2. Compatibility Testing: In accordance with ASTM C1087.
  - 3. Allow sufficient time for testing to avoid delaying the work.
  - 4. Deliver to manufacturer sufficient samples for testing.
  - 5. Report manufacturer's recommended corrective measures, if any, including primers or techniques not indicated in product data submittals.
  - 6. Testing is not required if sealant manufacturer provides data showing previous testing, not older than 24 months, that shows satisfactory adhesion, lack of staining, and compatibility.
- F. Installation Plan: Include schedule of sealed joints, including the following.
  - 1. Joint width indicated in Contract Documents.
  - 2. Joint depth indicated in Contract Documents; to face of backing material at centerline of joint.
  - 3. Method to be used to protect adjacent surfaces from sealant droppings and smears, with acknowledgement that some surfaces cannot be cleaned to like-new condition and therefore prevention is imperative.
  - 4. Approximate date of installation, for evaluation of thermal movement influence.
  - 5. Installation Log Form: Include the following data fields, with known information filled out.
    - a. Location on project.
    - b. Substrates.

- c. Sealant used.
  - d. Primer to be used, or indicate as "No primer" used.
  - e. Size and actual backing material used.
  - f. Date of installation.
  - g. Name of installer.
  - h. Actual joint width; provide space to indicate maximum and minimum width.
  - i. Actual joint depth to face of backing material at centerline of joint.
  - j. Air temperature.
- G. Preinstallation Field Adhesion Test Plan: Include destructive field adhesion testing of one sample of each combination of sealant type and substrate, except interior acrylic latex sealants, and include the following for each tested sample.
1. Identification of testing agency.
  2. Name(s) of sealant manufacturers' field representatives who will be observing
  3. Preinstallation Field Adhesion Test Log Form: Include the following data fields, with known information filled out.
    - a. Substrate; if more than one type of substrate is involved in a single joint, provide two entries on form, for testing each sealant substrate side separately.
    - b. Test date.
    - c. Location on project.
    - d. Sealant used.
    - e. Stated movement capability of sealant.
    - f. Test method used.
    - g. Date of installation of field sample to be tested.
    - h. Date of test.
    - i. Copy of test method documents.
    - j. Age of sealant upon date of testing.
    - k. Test results, modeled after the sample form in the test method document.
    - l. Indicate use of photographic record of test.
- H. Field Quality Control Plan:
1. Visual inspection of entire length of sealant joints.
  2. Non-destructive field adhesion testing of sealant joints, except interior acrylic latex sealants.
    - a. For each different sealant and substrate combination, allow for one test every 12 inches (305 mm) in the first 10 linear feet (3 linear meters) of joint and one test every 24 inches (610 mm) thereafter.
    - b. If any failures occur in the first 10 linear feet (3 linear meters), continue testing at 12 inch (305 mm) intervals at no extra cost to Owner.
  3. Destructive field adhesion testing of sealant joints, except interior acrylic latex sealant.
    - a. For each different sealant and substrate combination, allow for one test every 100 feet (30 meters) in the first 1000 linear feet (305 linear meters), and one test per 1000 linear feet (305 meters) thereafter, or once per floor on each elevation.
    - b. If any failures occur in the first 1000 linear feet (305 linear meters), continue testing at frequency of one test per 500 linear feet (152 linear meters) at no extra cost to Owner.
  4. Field testing agency's qualifications.
  5. Field Quality Control Log Form: Show same data fields as on Preinstallation Field Adhesion Test Log, with known information filled out and lines for multiple tests per sealant/substrate combinations; include visual inspection and specified field testing; allow for possibility that more tests than minimum specified may be necessary.
- I. Field Adhesion Test Procedures:

1. Allow sealants to fully cure as recommended by manufacturer before testing.
  2. Have a copy of the test method document available during tests.
  3. Take photographs or make video records of each test, with joint identification provided in the photos/videos; for example, provide small erasable whiteboard positioned next to joint.
  4. Record the type of failure that occurred, other information required by test method, and the information required on the Field Quality Control Log.
  5. When performing destructive tests, also inspect the opened joint for proper installation characteristics recommended by manufacturer, and report any deficiencies.
  6. Deliver the samples removed during destructive tests in separate sealed plastic bags, identified with project, location, test date, and test results, to Owner.
  7. If any combination of sealant type and substrate does not show evidence of minimum adhesion or shows cohesion failure before minimum adhesion, report results to Architect.
- J. Non-Destructive Field Adhesion Test: Test for adhesion in accordance with ASTM C1521, using Nondestructive Spot Method.
1. Record results on Field Quality Control Log.
  2. Repair failed portions of joints.
- K. Destructive Field Adhesion Test: Test for adhesion in accordance with ASTM C1521, using Destructive Tail Procedure.
1. Sample: At least 18 inch (457 mm) long.
  2. Minimum Elongation Without Adhesive Failure: Consider the tail at rest, not under any elongation stress; multiply the stated movement capability of the sealant in percent by two; then multiply 1 inch (25 mm) by that percentage; if adhesion failure occurs before the "1 inch mark" is that distance from the substrate, the test has failed.
  3. If either adhesive or cohesive failure occurs prior to minimum elongation, take necessary measures to correct conditions and re-test; record each modification to products or installation procedures.
  4. Record results on Field Quality Control Log.
  5. Repair failed portions of joints.

#### **1.06 MOCK-UP**

- A. Mockups: Install sealant in mockups of assemblies specified in other Sections that are indicated to receive joint sealants specified in this Section. Use materials and installation methods specified in this Section.
- B. Construct mock-up with specified sealant types and with other components noted.
- C. Locate where directed.
- D. Mock-up may remain as part of the Work.

#### **1.07 DELIVERY, STORAGE, AND HANDLING**

- A. Comply with requirements of Section 01 6000.
- B. Deliver materials to Project site in original unopened containers or bundles with labels indicating manufacturer, product name and designation, color, expiration period for use, pot life, curing time, and mixing instructions for multi-component materials.
- C. Store and handle materials in compliance with manufacturer's recommendations to prevent their deterioration or damage due to moisture, high or low temperatures, contaminants, or other causes.

### 1.08 FIELD CONDITIONS

- A. Environmental Conditions: Do not proceed with installation of joint sealants under the following conditions:
  - 1. When ambient and substrate temperature conditions are outside the limits permitted by joint sealant manufacturer.
  - 2. When joint substrates are wet.
- B. Joint Width Conditions: Do not proceed with installation of joint sealants where joint widths are less than allowed by joint sealant manufacturer for application indicated.
- C. Joint Substrate Conditions: Do not proceed with installation of joint sealants until contaminants capable of interfering with their adhesion are removed from joint substrates.
- D. Maintain temperature and humidity recommended by the sealant manufacturer during and after installation.

### 1.09 COORDINATION

- A. Coordinate the work with all sections referencing this section.

### 1.10 WARRANTY

- A. See Section 01 7000 - Closeout Submittals, for additional warranty requirements.
- B. Correct defective work within a five year period after Date of Substantial Completion.
- C. Warranty: Include coverage for installed sealants and accessories that fail to achieve watertight seal , exhibit loss of adhesion or cohesion, or do not cure.

## PART 2 PRODUCTS

### 2.01 SYSTEM DESCRIPTION

- A. Performance Requirements:
  - 1. Building envelope:
    - a. Make watertight and weathertight without causing staining or deterioration of joint substrates.
    - b. Exterior work that does not remain watertight and all work which does not retain all properties inherent in the product as stipulated by the manufacturer will be considered faulty.
- B. Building Exterior and Interior:
  - 1. Seal the following joints with joint sealer:
    - a. Expansion and control joints in exterior walls, copings, parapets.
    - b. Expansion and control joints in interior concrete slab floors.
    - c. Joints between metal panels.
    - d. Joints between door and window frames and adjacent materials.
    - e. Joints between cabinets and countertops and walls.
    - f. Control joints in interior partitions, including portion above ceilings.
    - g. Expansion and control joints in solid exterior soffits.
    - h. Control joints in interior ceilings and soffits.
  - 2. Apply continuous bead of joint sealer in the following locations during installation of materials specified elsewhere:
    - a. In lap joints of sheet metal construction.
    - b. Roofing panels and roof-related sheet metal and flashing.
    - c. Between partition floor and ceiling tracks and adjacent construction.

- d. Between end stud of partition and adjacent construction.
- e. Under door sills.
3. Acoustic Sealants at acoustic separations shall make assembly airtight.
  - a. Seal perimeter and intersections of finish.
  - b. Seal around electrical boxes and other penetrations of finish; seal holes within electrical boxes; seal conduit ends.
  - c. Seal pipes which penetrate acoustic separations.
4. Joints not specifically mentioned above which require sealants to meet the performance criteria cited in this section.

## 2.02 MATERIALS

- A. Sealants and Primers - General: Provide products having volatile organic compound (VOC) content as specified in Section 01 6116.
- B. Compatibility: Provide joint sealants, joint fillers, and other related materials that are compatible with one another and with joint substrates under conditions of service and application, as demonstrated by sealant manufacturer based on testing and field experience.
- C. Liquid-Applied Joint Sealants: Comply with ASTM C 920 and other requirements indicated for each liquid-applied joint sealant specified, including those referencing ASTM C 920 classifications for type, grade, class, and uses related to exposure and joint substrates.
- D. Stain-Test-Response Characteristics: Where sealants are specified to be nonstaining to porous substrates, provide products that have undergone testing according to ASTM C 1248 and have not stained porous joint substrates indicated for Project.
- E. Suitability for Contact with Food: Where sealants are indicated for joints that will come in repeated contact with food, provide products that comply with 21 CFR 177.2600.
- F. Colors: Provide color of exposed joint sealants to comply with the following:
  1. Provide colors matching selections made by Architect from manufacturer's full range of colors for products of type indicated. Colors may be listed in schedule at the end of this section or on the drawings. Request color selection for all products listed without a preselected color.

## 2.03 JOINT SEALANT APPLICATIONS

- A. Scope:
  1. Exterior Joints: Seal open joints, whether or not the joint is indicated on drawings, unless specifically indicated not to be sealed. Exterior joints to be sealed include, but are not limited to, the following items.
    - a. Wall expansion and control joints.
    - b. Joints between door, window, and other frames and adjacent construction.
    - c. Joints between different exposed materials.
    - d. Openings below ledge angles in masonry.
    - e. Other joints indicated below.
  2. Interior Joints: Do not seal interior joints unless specifically indicated to be sealed. Interior joints to be sealed include, but are not limited to, the following items.
    - a. Joints between door, window, and other frames and adjacent construction.
    - b. In sound-rated wall and ceiling assemblies, gaps at electrical outlets, wiring devices, piping, and other openings; between wall/ceiling and other construction; and other flanking sound paths.
    - c. Other joints indicated below.



3. Do not seal the following types of joints.
  - a. Intentional weepholes in masonry.
  - b. Intentional weepholes in window assemblies and head flashings.
  - c. Joints indicated to be treated with manufactured expansion joint cover or some other type of sealing device.
  - d. Joints where sealant is specified to be provided by manufacturer of product to be sealed.
  - e. Joints where installation of sealant is specified in another section.
  - f. Joints between suspended panel ceilings/grid and walls.
- B. Sound-Rated Assemblies: Walls and ceilings identified as "STC-rated", "sound-rated", or "acoustical".

#### 2.04 JOINT SEALANTS - GENERAL

- A. Sealants and Primers: Provide products with levels of volatile organic compound (VOC) content as indicated in Section 01 6116.
- B. Colors: As indicated on the drawings. If no colors are indicated, request colors before preparation of schedule submittals and include on all schedule submittals.

#### 2.05 NONSAG JOINT SEALANTS

- A. Non-Staining Silicone Sealant: ASTM C920, Grade NS, Uses M and A; not expected to withstand continuous water immersion or traffic.
  1. Movement Capability: Plus and minus 50 percent, minimum.
  2. Non-Staining To Porous Stone: Non-staining to light-colored natural stone when tested in accordance with ASTM C1248.
  3. Dirt Pick-Up: Reduced dirt pick-up compared to other silicone sealants.
  4. Hardness Range: 15 to 35, Shore A, when tested in accordance with ASTM C661.
  5. Color: To be selected by Architect from manufacturer's standard range.
  6. Service Temperature Range: Minus 20 to 180 degrees F (Minus 29 to 82 degrees C).
  7. Manufacturers:
    - a. Dow Chemical Company; DOWSIL 790 Silicone Building Sealant: [consumer.dow.com](http://consumer.dow.com).
    - b. Pecora Corporation: [www.pecora.com](http://www.pecora.com).
    - c. Sika Corporation; Sikasil WS-290: [www.usa-sika.com](http://www.usa-sika.com).
    - d. Substitutions: See Section 01 6000 - Product Requirements.
- B. Silicone Sealant: ASTM C920, Grade NS, Uses M and A; not expected to withstand continuous water immersion or traffic.
  1. Movement Capability: Plus and minus 50 percent, minimum.
  2. Hardness Range: 15 to 35, Shore A, when tested in accordance with ASTM C661.
  3. Color: To be selected by Architect from manufacturer's standard range.
  4. Cure Type: Single-component, neutral moisture curing
  5. Service Temperature Range: Minus 65 to 180 degrees F (Minus 54 to 82 degrees C).
  6. Manufacturers:
    - a. Dow Corning Corporation; 795: [www.dowcorning.com](http://www.dowcorning.com).
    - b. Substitutions: See Section 01 6000 - Product Requirements.
- C. Silicone Sealant: ASTM C920, Type S, Grade NS, Class 25, single component, neutral curing, non-sagging, non-staining, non-bleeding, RTV silicone designed for adhesion to low energy surfaces common in sheet or peel-and-stick flexible flashings and air/weather barriers.
  1. Color: To be selected by Architect from manufacturer's standard range.
  2. Service Temperature Range: -65 to 180 degrees F (-54 to 82 degrees C).

3. Products:
  - a. Dow Corning Corporation; 758: [www.dowcorning.com](http://www.dowcorning.com).
  - b. Sika Corporation, Construction Products Division; Sikasil-N.
  - c. Substitutions: See Section 01 6000 - Product Requirements.
  
- D. Mildew-Resistant Silicone Sealant: ASTM C920, Grade NS, Uses M and A, Class 25; single component, mildew resistant; not expected to withstand continuous water immersion or traffic.
  1. Color: White.
  2. Manufacturers:
    - a. BASF Construction Chemicals-Building Systems; Omniplus: [www.buildingsystems.basf.com](http://www.buildingsystems.basf.com).
    - b. Dow Corning Corporation; 786-M White.
    - c. GE Construction Sealants; SCS1700 Sanitary.
    - d. Pecora Corporation; Pecora 898 NST (Non-Staining Technology): [www.pecora.com/#sle](http://www.pecora.com/#sle).
    - e. Substitutions: See Section 01 6000 - Product Requirements.
  
- E. Polyurethane Sealant: ASTM C920, Grade NS, Uses M and A; single or multi-component; not expected to withstand continuous water immersion or traffic.
  1. Movement Capability: Plus and minus \_\_\_\_ percent, minimum.
  2. Hardness Range: 20 to 35, Shore A, when tested in accordance with ASTM C661.
  3. Color: Custom as selected..
  4. Manufacturers:
    - a. BASF Building Systems, MasterSeal (Sonolastic) NP-2.
    - b. Sika Corporation; Sikaflex-2c NS: [www.usa-sika.com/#sle](http://www.usa-sika.com/#sle).
    - c. Substitutions: See Section 01 6000 - Product Requirements.
  
- F. Polyurethane Sealant: ASTM C920, Grade NS, Uses M and A; single component; not expected to withstand continuous water immersion or traffic.
  1. Movement Capability: Plus and minus 25 percent, minimum.
  2. Hardness Range: 20 to 35, Shore A, when tested in accordance with ASTM C661.
  3. Color: To be selected by Architect from manufacturer's standard range.
  4. Products:
    - a. BASF Building Systems, MasterSeal (Sonolastic) NP-1.
    - b. Sika Corporation; Sikaflex-1a: [www.usa-sika.com](http://www.usa-sika.com).
    - c. Substitutions: See Section 01 6000 - Product Requirements.
  
- G. Acrylic Emulsion Latex: Water-based; ASTM C834, single component, non-staining, non-bleeding, non-sagging; not intended for exterior use, paintable.
  1. Color: To be selected by Architect from manufacturer's standard range.
  2. Manufacturers:
    - a. BASF Construction Chemicals-Building Systems; Sonolac: [www.buildingsystems.basf.com](http://www.buildingsystems.basf.com).
    - b. Pecora Corporation; AC-20 +Silicone: [www.pecora.com/#sle](http://www.pecora.com/#sle).
    - c. Substitutions: See Section 01 6000 - Product Requirements.
  
- H. Non-Curing Butyl Sealant: Solvent-based, single component, non-sag, non-skinning, non-hardening, non-bleeding; non-vapor-permeable; intended for fully concealed applications.
  1. Manufacturers:

- a. Pecora Corporation; Pecora BA-98 Non-Skinning Butyl Sealant: [www.pecora.com/#sle](http://www.pecora.com/#sle).
  - b. Substitutions: See Section 01 6000 - Product Requirements.
- I. Acoustical Sealant: Acrylic sealant; ASTM C 920, Grade NS, Class 12-1/2, Uses M and A; single component, solvent release curing, non-skinning, ASTM C-834, nonsag, paintable, nonstaining latex sealant. Effectively reduce airborne sound transmission through perimeter joints and openings in building construction as demonstrated by testing representative assemblies according to ASTM E 90.
1. Composition: Acrylic latex emulsion sealant.
  2. Products:
    - a. Pecora Corporation; AC-20 FTR Acoustical and Insulation Sealant: [www.pecora.com](http://www.pecora.com), at fire-rated construction.
    - b. Hilti, Inc.; CP 506 Smoke and Acoustical Sealant: [www.us.hilti.com](http://www.us.hilti.com).
    - c. Hilti, Inc.; CP 572 Smoke and Acoustical Spray Sealant: [www.us.hilti.com](http://www.us.hilti.com).
    - d. BASF Construction Chemicals-Building Systems; MasterSeal NP250: [www.buildingsystems.basf.com](http://www.buildingsystems.basf.com).
    - e. Substitutions: See Section 01 6000 - Product Requirements.

## 2.06 SELF-LEVELING SEALANTS

- A. Self-Leveling Polyurethane Sealant: ASTM C920, Grade P, Uses M and A; single or multi-component; explicitly approved by manufacturer for traffic exposure; not expected to withstand continuous water immersion .
1. Movement Capability: Plus and minus 25 percent, minimum.
  2. Hardness Range: 35 to 55, Shore A, when tested in accordance with ASTM C661.
  3. Color: To be selected by Architect from manufacturer's standard range.
  4. Color at colored concrete: Custom-mixed colors matching colored concrete floors or paving.
  5. Service Temperature Range: Minus 40 to 180 degrees F (Minus 40 to 82 degrees C).
  6. Manufacturers:
    - a. BASF Construction Chemicals-Building Systems; MasterSeal (Sonneborn) SL-2 Slope Grade or Self Leveling Sealant: [www.buildingsystems.basf.com](http://www.buildingsystems.basf.com).
    - b. Sika Corporation; Sikaflex-2c SL: [www.usa-sika.com/#sle](http://www.usa-sika.com/#sle).
    - c. Substitutions: See Section 01 6000 - Product Requirements.
- B. Concrete Paving Joint Sealant: Polyurethane, pourable self-leveling; ASTM C920, Class 25, Uses T, I, M and A; multi- component.
1. Color: Custom mixed color matching colored concrete.
  2. Products:
    - a. BASF Construction Chemicals-Building Systems; MasterSeal (Sonneborn) SL-2: [www.buildingsystems.basf.com](http://www.buildingsystems.basf.com).
    - b. Pecora Corporation; Dyna-Trol II-SG: [www.pecora.com](http://www.pecora.com).
    - c. Sika Corporation, Construction Products Division; Sikaflex 2C-SL.
    - d. Substitutions: See Section 01 6000 - Product Requirements.
- C. High Quality Latex-Based Sound Sealant: ASTM C834, Type OP an opaque sealant, and Grade 0 Degrees C (32 Degrees F) meets requirements for low-temperature flexibility.
1. Color: White.
  2. Manufacturers:
    - a. Everkem Diversified Products, Inc; Sound Seal 90: [www.everkemproducts.com/#sle](http://www.everkemproducts.com/#sle).
    - b. Substitutions: See Section 01 6000 - Product Requirements.

- D. Semi-Rigid Self-Leveling Epoxy Joint Filler: Epoxy or epoxy/polyurethane copolymer; intended for filling cracks and control joints not subject to significant movement; rigid enough to support concrete edges under traffic.
1. Meet requirements of American Concrete Institute 302.1 R-04 "Guide for Concrete Floor and Slab Construction" and American Concrete Institute 360 R10 "Guide to Design of Slabs-on-Ground" for industrial floor joint fillers
  2. Composition: Multi-component, 100 percent solids by weight.
  3. Durometer Hardness: Minimum of 85 for Type A or 35 for Type D, after seven days when tested in accordance with ASTM D2240.
  4. Color: To be selected by Architect from manufacturer's standard colors.
  5. Joint Width, Minimum: 1/8 inch (3 mm).
  6. Joint Width, Maximum: 1/4 inch (6 mm).
  7. Joint Depth: Provide product suitable for joints from 1/8 inch (3 mm) to 2 inches (51 mm) in depth including space for backer rod.
  8. Manufacturers:
    - a. Euco 700 by The Euclid Chemical Company.
    - b. MM-80 by Metzger-McGuire.
    - c. BASF Construction Chemicals, MasterSeal CR190.
    - d. W.R. Meadows, Inc; Rezi-Weld Flex: [www.wrmeadows.com/#sle](http://www.wrmeadows.com/#sle).
    - e. Substitutions: See Section 01 6000 - Product Requirements.

## 2.07 ACCESSORIES

- A. Backer Rod: Cylindrical cellular foam rod with surface that sealant will not adhere to, compatible with specific sealant used, and recommended by backing and sealant manufacturers for specific application.
- B. Tape Sealant: Double-sided rubber-backed butyl tape sealant, 35 mil thickness, adhesive strength 88 oz/in. Widths as required to suit application, black color. Grainger, [www.grainger.com](http://www.grainger.com).
1. Substitutions: See Section 01 6000 - Product Requirements.
- C. Backing Tape: Self-adhesive polyethylene tape with surface that sealant will not adhere to and recommended by tape and sealant manufacturers for specific application.
- D. Masking Tape: Self-adhesive, nonabsorbent, non-staining, removable without adhesive residue, and compatible with surfaces adjacent to joints and sealants.
- E. Joint Cleaner: Non-corrosive and non-staining type, type recommended by sealant manufacturer; compatible with joint forming materials.
- F. Primers: Type recommended by sealant manufacturer to suit application; non-staining.

## PART 3 EXECUTION

### 3.01 EXAMINATION

- A. Verify that joints are ready to receive work.
- B. Verify that backing materials are compatible with sealants.
- C. Verify that backer rods are of the correct size.
- D. Preinstallation Adhesion Testing: Install a sample for each test location indicated in the test plan.
  1. Test each sample as specified in PART 1 under QUALITY ASSURANCE article.

2. Notify Architect of date and time that tests will be performed, at least 7 days in advance.
3. Arrange for sealant manufacturer's technical representative to be present during tests.
4. Record each test on Preinstallation Adhesion Test Log as indicated.
5. If any sample fails, review products and installation procedures, consult manufacturer, or take whatever other measures are necessary to ensure adhesion; re-test in a different location; if unable to obtain satisfactory adhesion, report to Architect.
6. After completion of tests, remove remaining sample material and prepare joint for new sealant installation.

### **3.02 PREPARATION**

- A. Remove loose materials and foreign matter that could impair adhesion of sealant.
- B. Clean joints, and prime as necessary, in accordance with manufacturer's instructions.
- C. Perform preparation in accordance with manufacturer's instructions and ASTM C1193.
- D. Mask elements and surfaces adjacent to joints from damage and disfigurement due to sealant work; be aware that sealant drips and smears may not be completely removable.

### **3.03 INSTALLATION**

- A. Perform work in accordance with sealant manufacturer's requirements for preparation of surfaces and material installation instructions.
- B. Perform installation in accordance with ASTM C1193.
- C. Perform acoustical sealant application work in accordance with ASTM C919.
- D. Measure joint dimensions and size joint backers to achieve width-to-depth ratio, neck dimension, and surface bond area as recommended by manufacturer, except where specific dimensions are indicated.
- E. Install bond breaker backing tape where backer rod cannot be used.
- F. Install sealant free of air pockets, foreign embedded matter, ridges, and sags, and without getting sealant on adjacent surfaces.
- G. Do not install sealant when ambient temperature is outside manufacturer's recommended temperature range, or will be outside that range during the entire curing period, unless manufacturer's approval is obtained and instructions are followed.
- H. Install sealants by proven techniques that result in sealants directly contacting and fully wetting joint substrates, completely filling recesses provided for each joint configuration, and providing uniform, cross sectional shapes and depths relative to joint widths that allow optimum sealant movement capability. Install sealants at the same time sealant backings are installed.
- I. Nonsag Sealants: Tool surface concave, unless otherwise indicated; remove masking tape immediately after tooling sealant surface.
  1. Immediately after sealant application and prior to time skinning or curing begins, tool sealants to form smooth, uniform beads of configuration indicated, to eliminate air pockets, and to ensure contact and adhesion of sealant with sides of joint. Remove excess sealants from surfaces adjacent to joint. Do not use tooling agents that discolor sealants or adjacent surfaces or are not approved by sealant manufacturer.
  2. Provide concave joint configuration per Figure 8A in ASTM C 1193, unless otherwise indicated.
  3. Provide flush joint configuration, per Figure 8B in ASTM C 1193, where indicated.

4. Provide recessed joint configuration, per Figure 8C in ASTM C 1193, of recess depth and at locations indicated.
  - a. Use masking tape to protect adjacent surfaces of recessed tooled joints.

J. Concrete Floor Joint Filler: After full cure, shave joint filler flush with top of concrete slab.

### **3.04 FIELD QUALITY CONTROL**

- A. Perform field quality control inspection/testing as specified in PART 1 under QUALITY ASSURANCE article.
- B. Non-Destructive Adhesion Testing: If there are any failures in first 100 linear feet (30 linear m), notify Architect immediately.
- C. Destructive Adhesion Testing: If there are any failures in first 1000 linear feet (300 linear m), notify Architect immediately.
- D. Remove and replace failed portions of sealants using same materials and procedures as indicated for original installation.
- E. Repair destructive test location damage immediately after evaluation and recording of results.

### **3.05 FINISHING**

- A. Work that is exposed to view: Uniform surface with neat, straight edges and no excess material on adjacent surface.

### **3.06 CLEANING**

- A. Clean adjacent soiled surfaces.

### **3.07 PROTECTION**

- A. Protect sealants until cured. Replace damaged work with repairs indistinguishable from original work.

### **3.08 SCHEDULE**

- A. Architect will provide color selections and locations for each sealant type and for Contractor's use. Not all locations will have the same color.
  1. Custom colors will be required.
- B. Exterior Locations:
  1. Joints which are bordered by glass: Single-Component, Nonsag, Neutral-Curing Silicone Joint Sealant: ASTM C 920, Type S, Grade NS, Class 50, for Use NT.
  2. Joints which are bordered by plastic: Single-Component, Nonsag, Neutral-Curing Silicone Joint Sealant: ASTM C 920, Type S, Grade NS, Class 100/50, for Use NT.
  3. Horizontal joints in sidewalks, decks, concrete floors, and driveways: Exterior or Interior Horizontal Expansion Joint Sealant - Polyurethane, self-leveling; ASTM C 920, Grade P, Class 25, Uses T, M and A; single component.
    - a. At walk expansion joints.
    - b. Where walks abut structural slabs or stoops.
    - c. Where walks abut exterior wall of buildings.
    - d. Where exposed interior concrete slabs abut vertical surfaces.
    - e. Where sealant is shown on the Drawings for concrete slabs.

4. Locations requiring adhesion to low energy surfaces common in sheet or peel-and-stick flexible flashings and air/weather barriers: ASTM C920, Type S, Grade NS, Class 25, single component, neutral curing, non-sagging, non-staining, non-bleeding, RTV silicone.
  5. Membrane Roofing Sealants: Types recommended by roofing manufacturer and complying with requirements of this section.
  6. Steep Slope Roofing Sealants: Types recommended by roofing manufacturer and complying with requirements of this section.
  7. Sheet Metal and Roof Accessory Sealants: Types recommended by roofing manufacturer and complying with requirements of this section.
  8. All other exterior joints including around perimeters of frames where door, window and louver frames abut concrete, masonry or other building materials (interior and exterior), Sills and thresholds, and at miscellaneous locations where sealant is shown on Drawings, exterior joints where no other sealant is indicated:
    - a. Multicomponent, Nonsag, Urethane Joint Sealant: ASTM C 920, Type M, Grade NS, Class 25, for Use NT, M, A and O; capable of 50% extension and compression movement.
    - b. Single-Component, Nonsag, Urethane Joint Sealant: ASTM C 920, Type S, Grade NS, Class 25, for Use NT.
  9. Exterior Sheet Metal Lap Joints: Types recommended by manufacturer and complying with requirements of this section.
  10. Exterior Metal Panel Butt Joints and trim: Types recommended by manufacturer and complying with requirements of this section.
- C. Interior Locations:
1. Expansion and control joints, around perimeters of frames where door, window and louver frames abut concrete, masonry or other building materials, sills and thresholds, and at miscellaneous locations where sealant is shown on Drawings:
    - a. Multicomponent, Nonsag, Urethane Joint Sealant: ASTM C 920, Type M, Grade NS, Class 25, for Use NT, M, A and O; capable of 50% extension and compression movement.
    - b. Single-Component, Nonsag, Urethane Joint Sealant: ASTM C 920, Type S, Grade NS, Class 25, for Use NT.
  2. Interior Concrete Slabs on Grade:
    - a. General Locations: Exterior or Interior Horizontal Expansion Joint Sealant: Polyurethane, self-leveling; ASTM C 920, Grade P, Class 25, Uses T, M and A; single component.
  3. Interior wet areas, around plumbing fixtures, countertops abutting walls, food service applications: Mildew-Resistant, Single-Component, Acid-Curing Silicone Joint Sealant: ASTM C 920, Type S, Grade NS, Class 25, for Use NT, A and O.
  4. Interior static dry joints as required to dress appearance, Other interior joints for which no other type of sealant is indicated.: Latex Joint Sealant: Acrylic latex or siliconized acrylic latex, ASTM C 834, Type OP, Grade NF.
  5. Where required for sound control: Acoustical Sealant, ASTM C-834.
  6. Where required for sound control with limited flame spread: Acoustical Sealant, ASTM C-834, fire-rated type.
- D. General:
1. Joints in construction between interior and exterior spaces and other designated or required locations to provide effective barrier against passage of elements, Other joints for which no other type of sealant is indicated.:

- a. Multicomponent, Nonsag, Urethane Joint Sealant: ASTM C 920, Type M, Grade NS, Class 25, for Use NT, M, A and O; capable of 50% extension and compression movement.
  - b. Single-Component, Nonsag, Urethane Joint Sealant: ASTM C 920, Type S, Grade NS, Class 25, for Use NT.
2. Specialty perimeters where required for appearance or weathertightness:
- a. Multicomponent, Nonsag, Urethane Joint Sealant: ASTM C 920, Type M, Grade NS, Class 25, for Use NT, M, A and O; capable of 50% extension and compression movement.
  - b. Single-Component, Nonsag, Urethane Joint Sealant: ASTM C 920, Type S, Grade NS, Class 25, for Use NT.

### **3.09 POST-OCCUPANCY**

- A. Post-Occupancy Inspection: Perform visual inspection of entire length of project sealant joints at a time that joints have opened to their greatest width; i.e. at low temperature in thermal cycle. Report failures immediately and repair.

**END OF SECTION**



**SECTION 07 9513**  
**EXPANSION JOINT COVER ASSEMBLIES**

**PART 1 GENERAL**

**1.01 SECTION INCLUDES**

- A. Expansion joint cover assemblies for floor, wall, ceiling, and soffit surfaces.
- B. Roof control and expansion joint covers.
- C. Internal secondary gutter and drainage system

**1.02 RELATED REQUIREMENTS**

- A. Section 03 1000 - Concrete Forms and Accessories: Placement of joint assembly frames in formwork.
- B. Section 07 6200 - Sheet Metal Flashing and Trim: Roof expansion and control joint covers.
- C. Section 07 9200 - Joint Sealants: Sealing expansion and control joints using gunnable and pourable sealants.

**1.03 REFERENCE STANDARDS**

- A. ASTM B221 - Standard Specification for Aluminum and Aluminum-Alloy Extruded Bars, Rods, Wire, Profiles, and Tubes; 2014.
- B. ASTM B221M - Standard Specification for Aluminum and Aluminum-Alloy Extruded Bars, Rods, Wire, Profiles, and Tubes [Metric]; 2013.
- C. ASTM B308/B308M - Standard Specification for Aluminum-Alloy 6061-T6 Standard Structural Profiles; 2010.
- D. ASTM E 119 - Standard Test Methods for Fire Tests of Building Construction and Materials

**1.04 SUBMITTALS**

- A. See Section 01 3300 - Submittals, for submittal procedures.
- B. Product Data: Provide joint assembly profiles, profile dimensions, anchorage devices and available colors and finish.
  - 1. Submit manufacturer's installation instructions and copies of UL Classification with California State Fire Marshal listing numbers for fire rated joint covers.
- C. Shop Drawings: Indicate joint and splice locations, miters, layout of the work, affected adjacent construction and anchorage locations.
- D. Samples: Submit two samples 10 inch (\_\_\_\_ mm) long, illustrating profile, dimension, color, and finish selected.
- E. Manufacturer's Installation Instructions: Indicate rough-in sizes and required tolerances for item placement.

**1.05 QUALITY ASSURANCE**

- A. Provide systems by one manufacturer with a minimum of 5 years experience in fabrication of expansion joint systems.
- B. Fire rated joint covers shall have been tested by Underwriters Laboratories in accordance with ANSI/UL No. 263 and ASTM E 119, and the following criteria:

07 9513 - EXPANSION JOINT COVER ASSEMBLIES

1. In full-scale floor and wall furnaces.
2. With positive furnace pressures.
3. Passing both thermal conductivity and hose stream requirements.
4. Minimum deflection withstood during fire tests:
5. Wall systems: 4" deflection.

C. Field Measurements: Verify compliance with manufacturer's requirements.

## **1.06 EXTRA MATERIALS**

- A. See Section 01 6000 - Product Requirements, for additional provisions.
- B. Provide 18 ft (\_\_\_\_ mm) of resilient joint filler and special tools required for accessing and servicing components.

## **PART 2 PRODUCTS**

### **2.01 MANUFACTURERS**

- A. Expansion Joint Cover Assemblies:
  1. Balco, a CSW Industrials Company;
  2. Inpro: [www.inprocorp.com](http://www.inprocorp.com).
  3. Nystrom, Inc: [www.nystrom.com](http://www.nystrom.com).
  4. MM Systems Corporation.[www.mmsystemscorp.com](http://www.mmsystemscorp.com)
  5. Construction Specialties, Inc..[www.c-sgroup.com](http://www.c-sgroup.com).
  6. Watson Bowman Acme .[www.bacorp.com](http://www.bacorp.com)
- B. Substitutions: See Section 01 6000 - Product Requirements.

### **2.02 EXPANSION JOINT COVER ASSEMBLIES**

- A. Expansion Joint Cover Assemblies - General: Factory-fabricated and assembled; designed to completely fill joint openings, sealed to prevent passage of air, dust, water, smoke; suitable for traffic expected.
  1. Joint Dimensions and Configurations: As indicated on drawings.
  2. Joint Cover Sizes: Selected to suit joint width and configuration, based on manufacturer's published recommendations and limitations.
  3. Lengths: Provide covers in full lengths required; avoid splicing wherever possible.
  4. Anchors, Fasteners, and Fittings: Provided by cover manufacturer.

### **2.03 MATERIALS**

- A. Expansion Joint Covers: Shapes and profiles as indicated, as required, and as recommended by manufacturer to suit application. Fire rated assembly to match rating of walls, extruded aluminum, ASTM B221.
- B. Resilient Filler: Type appropriate for installation.
- C. Threaded Fasteners: Compatible with adjacent materials, sized as recommended by manufacturer in writing for proposed loading and use.
- D. Backing Paint: Asphaltic type.
- E. Fire barrier: Provide type required for indicated fire resistance and fabricated of layers of ceramic fiber insulation, metallic insulation.
- F. Flexible secondary internal gutter: Manufacturer's standard design accommodating required joint movement and compress without damage during full joint closure. Contain and drain excess collected moisture to building exterior through drainage tubes of similar flexibility.

Minimize material elongation from moisture or debris. Secure to foundation using blockouts for joint or other manufacturer approved method.

1. Wabo flexible Gutter System by Watson Bowman Acme, types to suit application.
2. Gutter profile: 0.060 inch thick single ply reinforced EPDM sheet. Shore A hardness minimum 60 +/- 5, width of profile as required by joint type and movement requirements.
3. Drain Tube: Provide 1-1/2 inch i.d. 1/8 inch wall clear PVC tubing.
4. Transition element: premolded 0.060 inch EPDM taper profile with pre-taped flange and adhesive for bond to underside of gutter profile.

G. Accessories, and other materials required for complete installation.

H. Extruded Aluminum: ASTM B221 (ASTM B221M), 6063 alloy, T6 temper; or ASTM B308/B308M, 6061 alloy, T6 temper.

1. Exposed Finish Outdoors: Natural anodized.
2. Exposed Finish at Walls and Ceilings: Natural anodized.

I. Resilient Seals:

1. For Pedestrian Traffic Applications: EPDM rubber, Neoprene, or Santoprene; no PVC; Shore A hardness of 40 to 50 Durometer.
2. For Vehicular Traffic Applications: EPDM rubber, Neoprene, or Santoprene; no PVC; Shore A hardness of 40 to 50 Durometer.
3. Color: As selected by Architect.

J. Anchors and Fasteners: As recommended by cover manufacturer.

K. Backing Paint for Aluminum Components in Contact with Cementitious Materials: Asphaltic type.

#### **2.04 FABRICATION**

A. Joint Covers: Aluminum cover plate, aluminum frame construction, retainers with resilient elastomeric filler strip, designed to permit plus or minus 50 percent joint movement with full recovery, flush mounted.

1. Fabricate special transitions, corner fittings, and end closures. Miter and weld joints

B. Back paint components in contact with cementitious materials.

C. Galvanize embedded ferrous metal anchors and fastening devices.

D. Shop assemble components and package with anchors and fittings.

E. Provide joint components in single length wherever practical. Minimize site splicing.

F. Insulation blanket and fire-resistive sealant as recommended by manufacturer to achieve indicated fire ratings.

#### **2.05 FINISHES**

A. Floors: Non-slip surfacing of aluminum oxide grit.

B. Walls and Ceilings: Clear anodized.

C. Resilient Filler Exposed to View: Gray.

### **PART 3 EXECUTION**

#### **3.01 EXAMINATION**

- A. Verify that joint preparation and dimensions are acceptable and in accordance with manufacturer's requirements.

#### **3.02 PREPARATION**

- A. Provide anchoring devices for installation and embedding .
  - 1. Provide templates and rough-in measurements.
- B. All surfaces to receive elastomeric compression seal shall be free from dirt, water, frost and any other loose foreign debris, which may be detrimental to effective joint sealing.
- C. Remove any and all accumulated debris from interstitial spaces before enclosure.

#### **3.03 INSTALLATION**

- A. Install components and accessories in accordance with manufacturer's instructions.
  - 1. Calculate and make allowances for change in joint size due to difference between installation and building operating temperatures
- B. Fire rated joint Covers: Install to requirements of fire rated design. Install fire barriers and flame sealant as required.
- C. Align work plumb and level, flush with adjacent surfaces.
- D. Elastomeric Compression Seals: Install utilizing manufacturer's lubricant adhesive. Utilize manufacturer's specialized installation tool as required to obtain specified fit and alignment.
- E. Install flexible gutter profile continuous along length of joint with drain tube assemblies spaced 25 feet on center, minimum of two drains per joint. Install drain systems as recommended by manufacturer. Direct all collected moisture to exterior of building.
- F. Rigidly anchor to substrate to prevent misalignment.

#### **3.04 PROTECTION**

- A. Do not permit traffic over unprotected floor joint surfaces.
- B. Provide strippable coating to protect finish surface.
- C. Where necessary, remove and store cover plate and install temporary protection over joints; reinstall cover plate before completion of work.
- D. Protect system and its components during construction. After work is complete in adjacent areas clean exposed surfaces with a suitable cleaner that will not harm or attack the elastomeric material.

**END OF SECTION**

**SECTION 08 1113  
HOLLOW METAL DOORS AND FRAMES**

**PART 1 GENERAL**

**1.01 SECTION INCLUDES**

- A. Non-fire-rated hollow metal doors and frames.
- B. Hollow metal frames for wood doors.
- C. Fire-rated hollow metal doors and frames.
- D. Thermally insulated hollow metal doors with frames.
- E. Hollow metal borrowed lites glazing and window frames.
- F. Accessories, including glazing, louvers, and matching panels.

**1.02 RELATED REQUIREMENTS**

- A. Section 08 7100 - Door Hardware.
- B. Section 08 8000: Glass for doors and borrowed lites.

**1.03 ABBREVIATIONS AND ACRONYMS**

- A. ANSI: American National Standards Institute.
- B. NFPA: National Fire Protection Association.
- C. SDI: Steel Door Institute.
- D. UL: Underwriters Laboratories.

**1.04 DEFINITIONS**

- A. Exterior doors: Doors exposed in whole or in part to the weather.
- B. Wet Areas: Exposed in whole or in part to areas where water is used in the room; toilets, custodial closets, food service, science classrooms, locker rooms and showers.

**1.05 REFERENCE STANDARDS**

- A. ADA Standards - Americans with Disabilities Act (ADA) Standards for Accessible Design; 2010.
- B. ANSI/SDI A250.4 - Test Procedure and Acceptance Criteria for Physical Endurance for Steel Doors, Frames and Frame Anchors; 2011.
- C. ANSI/SDI A250.8 - Specifications for Standard Steel Doors and Frames (SDI-100); 2014.
- D. ASTM A653/A653M - Standard Specification for Steel Sheet, Zinc-Coated (Galvanized) or Zinc-Iron Alloy-Coated (Galvannealed) by the Hot-Dip Process; 2015.
- E. ASTM A1008/A1008M - Standard Specification for Steel, Sheet, Cold-Rolled, Carbon, Structural, High-Strength Low-Alloy, High-Strength Low-Alloy with Improved Formability, Solution Hardened, and Bake Hardenable; 2015.
- F. ASTM A1011/A1011M - Standard Specification for Steel, Sheet and Strip, Hot-Rolled, Carbon, Structural, High-Strength Low-Alloy, High-Strength Low-Alloy with Improved Formability, and Ultra-High Strength; 2014.

- G. ASTM E84 - Standard Test Method for Surface Burning Characteristics of Building Materials; 2015a.
- H. BHMA A156.115 - American National Standard for Hardware Preparation in Steel Doors and Steel Frames; 2014.
- I. ICC A117.1 - Accessible and Usable Buildings and Facilities; 2009.
- J. ITS (DIR) - Directory of Listed Products; current edition.
- K. NAAMM HMMA 830 - Hardware Selection for Hollow Metal Doors and Frames; 2002.
- L. NAAMM HMMA 831 - Hardware Locations for Hollow Metal Doors and Frames; 2011.
- M. NAAMM HMMA 840 - Guide Specifications for Installation and Storage of Hollow Metal Doors and Frames; 2007.
- N. NAAMM HMMA 861 - Guide Specifications for Commercial Hollow Metal Doors and Frames; 2006.
- O. NFPA 80 - Standard for Fire Doors and Other Opening Protectives; 2016.
- P. NFPA 105 - Standard for Smoke Door Assemblies and Other Opening Protectives; 2016.
- Q. NFPA 252 - Standard Methods of Fire Tests of Door Assemblies; 2012.
- R. SDI 117 - Manufacturing Tolerances for Standard Steel Doors and Frames; 2013.
- S. UL (DIR) - Online Certifications Directory; current listings at database.ul.com.
- T. UL 10C - Standard for Positive Pressure Fire Tests of Door Assemblies; Current Edition, Including All Revisions.
- U. UL 1784 - Standard for Air Leakage Tests of Door Assemblies; Current Edition, Including All Revisions.

#### **1.06 SUBMITTALS**

- A. See Section 01 3300 - Submittals, for submittal procedures.
- B. Product Data: Materials and details of design and construction, hardware locations, reinforcement type and locations, anchorage and fastening methods, and finishes; and one copy of referenced standards/guidelines.
- C. Shop Drawings: Details of each opening, showing elevations, glazing, frame profiles, and any indicated finish requirements.
- D. Installation Instructions: Manufacturer's published instructions, including any special installation instructions relating to this project.
- E. Certificates: Provide manufacturer's certification of the following:
  - 1. Products comply with referenced standards.
  - 2. Each and every frame and hollow metal window, sidelite provided are UL listed and labeled for the fire rating indicated at the sizes shown.

#### **1.07 QUALITY ASSURANCE**

- A. Maintain at project site copies of reference standards relating to installation of products specified.

## 1.08 DELIVERY, STORAGE, AND HANDLING

- A. Comply with NAAMM HMMA 840 or ANSI/SDI A250.8 (SDI-100) in accordance with specified requirements.
- B. Protect with resilient packaging; avoid humidity build-up under coverings; prevent corrosion and adverse effects on factory applied painted finish.

## PART 2 PRODUCTS

### 2.01 MANUFACTURERS

- A. Hollow Metal Doors and Frames:
  - 1. Ceco Door, an Assa Abloy Group company: [www.assaabloydss.com](http://www.assaabloydss.com).
  - 2. Republic Doors, an Allegion brand: [www.republicdoor.com/#sle](http://www.republicdoor.com/#sle).
  - 3. Steelcraft, an Allegion brand: [www.allegion.com/us](http://www.allegion.com/us).
  - 4. Substitutions: See Section 01 6000 - Product Requirements.

### 2.02 PERFORMANCE REQUIREMENTS

- A. Requirements for Hollow Metal Doors and Frames:
  - 1. Steel Sheet: Comply with one or more of the following requirements; galvanized steel complying with ASTM A653/A653M, cold-rolled steel complying with ASTM A1008/A1008M, or hot-rolled pickled and oiled (HRPO) steel complying with ASTM A1011/A1011M, commercial steel (CS) Type B, for each.
  - 2. Accessibility: Comply with ICC A117.1 and ADA Standards.
  - 3. Exterior Door Top Closures: Flush end closure channel, with top and door faces aligned.
  - 4. Door Edge Profile: Hinged edge square, and lock edge beveled.
  - 5. Typical Door Face Sheets: Flush. Refer to Door Schedule for additional information.
  - 6. Glazed Lights: Non-removable stops on non-secure side; sizes and configurations as indicated on drawings. Style: Flush.
  - 7. Hardware Preparations, Selections and Locations: Comply with NAAMM HMMA 830 and NAAMM HMMA 831 or BHMA A156.115 and ANSI/SDI A250.8 (SDI-100) in accordance with specified requirements.
  - 8. Zinc Coating for Typical Interior and/or Exterior Locations: Provide metal components zinc-coated (galvanized) and/or zinc-iron alloy-coated (galvanized) by the hot-dip process in accordance with ASTM A653/A653M, with manufacturer's standard coating thickness, unless noted otherwise for specific hollow metal doors and frames.
    - a. A60/ZF180 (galvanized).
- B. Hollow Metal Panels: Same construction, performance, and finish as doors.
- C. Combined Requirements: If a particular door and frame unit is indicated to comply with more than one type of requirement, comply with the specified requirements for each type; for instance, an exterior door that is also indicated as being sound-rated must comply with the requirements specified for exterior doors and for sound-rated doors; where two requirements conflict, comply with the most stringent.
- D. Fire-rated Assemblies: Manufactured in accordance with Underwriters Laboratories Inc. or other approved independent testing laboratory and bearing their metal label affixed to both door and frame. Labels shall list fire rating and "UL 10B and 10C POSITIVE PRESSURE" label. Door labels shall also include smoke and draft "S" designation.
  - 1. Manufacture in accordance with positive pressure test, UL-10C.
  - 2. Comply with ITS/Warnock Hersey International "Category A Doors". Where intumescent edge seals are required on wood or composite doors installed in steel frames,

seal shall be built-in edge type. Edge seals are not allowed on frame. Only smoke and draft seals complying with the "S" rating are allowed to be installed on the frame.

3. Coordinate with specification Section 08 7100 Door Hardware as required for compliance with UL 10C test, positive pressure fire-rated components and fire door assemblies.

### 2.03 HOLLOW METAL DOORS

- A. Door Finish: Factory primed and field finished.
- B. Exterior Doors: Thermally insulated.
  1. Based on SDI Standards: ANSI/SDI A250.8 (SDI-100).
    - a. Level 3 - Extra Heavy-duty.
    - b. Physical Performance Level A, 1,000,000 cycles; in accordance with ANSI/SDI A250.4.
    - c. Model Types as indicated on Drawings.
    - d. Door Face Metal Thickness: 16 gage, 0.053 inch (1.3 mm), minimum.
    - e. Zinc Coating: A60/ZF180 galvanized coating; ASTM A653/A653M.
  2. Door Core Material: Polyisocyanurate, 2 lbs/cu ft minimum density.
    - a. Foam Plastic Insulation: Manufacturer's standard board insulation with maximum flame spread index (FSI) of 75, and maximum smoke developed index (SDI) of 450 in accordance with ASTM E84, and completely enclosed within interior of door.
  3. Door Thermal Resistance: R-Value of 9.9, minimum, for installed thickness of polyisocyanurate.
  4. Door Thickness: 1-3/4 inch (44.5 mm), nominal.
- C. Interior Doors, Non-Fire Rated:
  1. Based on SDI Standards: ANSI/SDI A250.8 (SDI-100).
    - a. Level 3 - Extra Heavy-duty.
    - b. Physical Performance Level A, 1,000,000 cycles; in accordance with ANSI/SDI A250.4.
    - c. Model Types as indicated on Drawings.
    - d. Door Face Metal Thickness: 16 gage, 0.053 inch (1.3 mm), minimum.
    - e. Zinc Coating: A60/ZF180 galvanized coating; ASTM A653/A653M at wet areas (toilet rooms, custodial, food service, locker and shower rooms).
  2. Door Core Material: Manufacturers standard core material/construction and in compliance with requirements.
  3. Door Thickness: 1-3/4 inch (44.5 mm), nominal.
- D. Fire-Rated Doors:
  1. Based on SDI Standards: ANSI/SDI A250.8 (SDI-100).
    - a. Level 3 - Extra Heavy-duty.
    - b. Physical Performance Level A, 1,000,000 cycles; in accordance with ANSI/SDI A250.4.
    - c. Model Types as indicated on Drawings.
    - d. Door Face Metal Thickness: 16 gage, 0.053 inch (1.3 mm), minimum.
    - e. Zinc Coating: A60/ZF180 galvanized coating; ASTM A653/A653M at wet areas (toilet rooms, custodial, food service, locker and shower rooms).
  2. Fire Rating: As indicated on Door Schedule, tested in accordance with UL 10C and NFPA 252 ("positive pressure fire tests").
    - a. Temperature-Rise Rating (TRR) Across Door Thickness: In accordance with local building code and authorities having jurisdiction.
    - b. Provide units listed and labeled by UL (DIR) or ITS (DIR).
    - c. Attach fire rating label to each fire rated unit.



- d. Smoke and Draft Control Doors (Indicated with letter "S" on Drawings and/or Door Schedule): Self-closing or automatic closing doors in accordance with NFPA 80 and NFPA 105, with fire-resistance-rated wall construction rated the same or greater than the fire-rated doors, and the following:
  - 1) Maximum Air Leakage: 3.0 cfm/sq ft (0.02 cu m/sec/sq m) of door opening at 0.10 inch w.g. (24.9 Pa) pressure, when tested in accordance with UL 1784 at both ambient and elevated temperatures.
  - 2) Gasketing: Provide gasketing or edge sealing as necessary to achieve leakage limit.
  - 3) Label: Include the "S" label on fire-rating label of door.
3. Door Core Material: Manufacturers standard core material/construction in compliance with requirements.
4. Door Thickness: 1-3/4 inch (44.5 mm), nominal.

#### 2.04 HOLLOW METAL FRAMES

- A. Comply with standards and/or custom guidelines as indicated for corresponding door in accordance with applicable door frame requirements.
- B. Frame Finish: Factory primed and field finished.
- C. Exterior Door Frames: Full profile/continuously welded type.
  1. Galvanizing: Components hot-dipped zinc-iron alloy-coated (galvannealed) in accordance with ASTM A653/A653M, with A40/ZF120 coating.
  2. Frame Metal Thickness: 12 gage, 0.093 inch (2.36 mm), minimum.
  3. Weatherstripping: Separate, see Section 08 7100.
- D. Interior Door Frames, Non-Fire Rated: Full profile/continuously welded type.
  1. Terminated Stops: Provide at interior doors; closed end stop terminated 6 inch (150 mm), maximum, above floor at 45 degree angle.
  2. Frame Metal Thickness: 14 gage, 0.067 inch (1.7 mm), minimum.
- E. Door Frames, Fire-Rated: Full profile/continuously welded type.
  1. Fire Rating: Same as door, labeled.
  2. Frame Metal Thickness: 16 gage, 0.053 inch (1.3 mm), minimum.
- F. Frames for Wood Doors: Comply with frame requirements in accordance with corresponding door.
- G. Mullions for Pairs of Doors: Fixed, with profile similar to jambs.
- H. Borrowed Lites Glazing Frames: Construction and face dimensions to match door frames, and as indicated on drawings.
- I. Transom Bars: Fixed, of profile same as jamb and head.
- J. Provide mortar guard boxes for hardware cut-outs in frames to be installed in masonry or to be grouted.
- K. Frames in Masonry Walls: Size to suit masonry coursing with head member 4 inch (102 mm) high to fill opening without cutting masonry units.
- L. Frames Wider than 48 inches (1219 mm): Reinforce with steel channel fitted tightly into frame head, flush with top.
- M. Frame Anchors: Furnished type of anchorage accepted by the Steel Door Institute. For wall conditions that do not permit installation of floor anchors furnish 1 additional wall anchor.

1. Floor anchors: Furnish 1 per jamb. Minimum 16 gauge galvanized steel. Type with 2 bolts to structure.
2. Jamb anchors:
  - a. Stud Partitions: Furnish 4 per jamb. Minimum 18 gauge and welded inside each jamb.

## **2.05 FRAME FABRICATION**

- A. Cut-out, reinforce, punch and tap for mortise hardware. Where frames are grouted fabricate mortises in frames with mortar-tight back cover. Punch frames and provide silencers except where scheduled to have door seals.
- B. Reinforce for surface hardware. Reinforce in accordance with ANSI A115 and SDI-107 except as specified for material gauge.
  1. Hinge: No. 7 gauge; 1-1/4-inch by 10-inch, minimum.
  2. Strikes: No. 16 gauge formed combination reinforcement and dust cover.
  3. Flush bolts, closers, and other surface mounted hardware: No. 12 gauge.

## **2.06 ACCESSORIES**

- A. Louvers: Roll formed steel with overlapping frame; finish same as door components; factory-installed.
  1. In Fire-Rated Doors: UL (DIR) or ITS (DIR) listed fusible link louver, same rating as door.
  2. Style: Sightproof inverted V blade.
  3. Security Louvers at exterior locations; Anemostat PLSL.
  4. Fasteners: Exposed, tamper proof fasteners oriented to secure side.
- B. Glazing: As specified in Section 08 8000, factory installed.
- C. Removable Stops: Formed sheet steel, shape as indicated on drawings, mitered or butted corners; prepared for countersink style tamper proof screws.
- D. Astragals for Double Doors: Specified in Section 08 7100.
- E. Mechanical Fasteners for Concealed Metal-to-Metal Connections: Self-drilling, self-tapping, steel with electroplated zinc finish.
- F. Silencers: Resilient rubber, fitted into drilled hole; provide three on strike side of single door, three on center mullion of pairs, and two on head of pairs without center mullions.
- G. Temporary Frame Spreaders: Provide for factory- or shop-assembled frames.

## **PART 3 EXECUTION**

### **3.01 EXAMINATION**

- A. Verify existing conditions before starting work.
- B. Verify that opening sizes and tolerances are acceptable.
- C. Verify that finished walls are in plane to ensure proper door alignment.

### **3.02 PREPARATION**

### **3.03 INSTALLATION**

- A. Install doors and frames in accordance with manufacturer's instructions and related requirements of specified door and frame standards or custom guidelines indicated.
- B. Fill all spaces between frame anchors and structure with approved shim material.

- C. Install fire rated units in accordance with NFPA 80.
- D. Coordinate frame anchor placement with wall construction.
- E. Install door hardware as specified in Section 08 7100.
- F. Comply with glazing installation requirements of Section 08 8000.

**3.04 TOLERANCES**

- A. Clearances Between Door and Frame: Comply with related requirements of specified frame standards or custom guidelines indicated in accordance with SDI 117 or NAAMM HMMA 861.
- B. Maximum Diagonal Distortion: 1/16 inch (1.6 mm) measured with straight edge, corner to corner.

**3.05 ADJUSTING**

- A. Adjust for smooth and balanced door movement.
- B. Protect completed work from damage. Replace damaged work.

**3.06 SCHEDULE**

- A. Refer to Door and Frame Schedule on the drawings.

**END OF SECTION**

**SECTION 08 1416**  
**FLUSH WOOD DOORS**

**PART 1 GENERAL**

**1.01 SECTION INCLUDES**

- A. Flush wood doors; flush and flush glazed configuration; fire-rated and non-rated.

**1.02 RELATED REQUIREMENTS**

- A. Section 01 6116 - Volatile Organic Compound (VOC) Content Restrictions.
- B. Section 01 8113 - Sustainable Design Requirements.
- C. Section 08 1113 - Hollow Metal Doors and Frames.
- D. Section 08 8000 - Glazing.
- E. Section 09 9123 - Interior Painting: Field finishing of doors.

**1.03 REFERENCE STANDARDS**

- A. ASTM C1172 - Standard Specification for Laminated Architectural Flat Glass; 2014.
- B. AWI/AWMAC/WI (AWS) - Architectural Woodwork Standards; 2014.
- C. AWMAC/WI (NAAWS) - North American Architectural Woodwork Standards, U.S. Version 3.0; 2016.
- D. California Code of Regulations, Title 24, Part 2, California Building Code (CBC), International Building Code.
- E. California Code of Regulations, Title 24, Part 11 California Green Building Standards Code, "CAL-Green".
- F. Manufacturer's specifications and recommendations.
- G. National Wood Window and Door Association (NWWDA) standard: I.S. 1-87.
- H. NFPA 80 - Standard for Fire Doors and Other Opening Protectives; 2016.
- I. UL 10B - Standard for Fire Tests of Door Assemblies; Current Edition, Including All Revisions.
- J. UL 10C - Standard for Positive Pressure Fire Tests of Door Assemblies; Current Edition, Including All Revisions.
- K. AWI/AWMAC/WI - Architectural Woodwork Standards (AWS); 2009.

**1.04 SUBMITTALS**

- A. See Section 01 3300 - Submittals for submittal procedures.
- B. Product Data: Indicate door core materials and construction; veneer species, type and characteristics.
- C. CAL-GREEN Submittals:
  - 1. Product Data - VOC Limits: For adhesives, sealants, fillers, primers and coatings, documentation including printed statement of VOC contents, comply with limits specified in related section.

2. Composite Wood Formaldehyde Limits: Provide certification that all products meet current CARB Airborne Toxic Control Measure (ATCM) for Composite Wood Formaldehyde Limits by Mandatory Compliance Dates as specified in related section.
- D. Shop Drawings: Show doors and frames, elevations, sizes, types, swings, undercuts, beveling, blocking for hardware, factory machining, factory finishing, cutouts for glazing and other details.
  1. Provide information as required by AWI/AWMAC/WI (AWS) or AWMAC/WI (NAAWS).
  2. Include certification program label.
- E. Manufacturer's Installation Instructions: Indicate special installation instructions.
- F. Warranty, executed in Owner's name.

#### **1.05 QUALITY ASSURANCE**

- A. Perform work in accordance with AWI/AWMAC/WI - Architectural Woodwork Standards (AWS); 2009, Section 9, Custom Grade.
- B. Finish doors in accordance with AWI/AWMAC/WI - Architectural Woodwork Standards (AWS); 2009, Section 5.
- C. Certifications: Furnish each shipment with affixed label or other identification indicating name of manufacturer and compliance with specified standard.
- D. Fire-rated Assemblies: Manufactured in accordance with Underwriters Laboratories Inc. or other approved independent testing laboratory and bearing their metal label affixed to both door and frame. Labels shall list fire rating and "UL 10B and 10C POSITIVE PRESSURE" label. Door labels shall also include smoke and draft "S" designation.
  1. Manufacture in accordance with positive pressure test, UL-10C.
  2. Comply with ITS/Warnock Hersey International "Category A Doors". Where intumescent edge seals are required on wood or composite doors installed in steel frames, seal shall be built-in edge type. Edge seals are not allowed on frame. Only smoke and draft seals complying with the "S" rating are allowed to be installed on the frame.
  3. Coordinate with specification Section 08 7100 Door Hardware as required for compliance with UL 10C test, positive pressure fire-rated components and fire door assemblies.

#### **1.06 DELIVERY, STORAGE, AND HANDLING**

- A. Package, deliver and store doors in accordance with specified quality standard.
- B. Accept doors on site in manufacturer's packaging. Inspect for damage.
- C. Protect doors with resilient packaging sealed with heat shrunk plastic. Do not store in damp or wet areas; or in areas where sunlight might bleach veneer. Seal top and bottom edges with tinted sealer if stored more than one week. Break seal on site to permit ventilation.

#### **1.07 PROJECT CONDITIONS**

- A. Coordinate the work with door opening construction, door frame and door hardware installation.

#### **1.08 WARRANTY**

- A. See Section 01 7000 - Contract Closeout for additional warranty requirements.
- B. Interior Doors: Provide manufacturer's warranty for the life of the installation.

- C. Provide warranty for the following term: All Doors - Life of Installation.
- D. Include coverage for delamination of veneer, warping beyond specified installation tolerances, defective materials, and telegraphing core construction.

## **PART 2 PRODUCTS**

### **2.01 PERFORMANCE REQUIREMENTS**

- A. VOC Limits for adhesives, sealants, fillers, primers and coatings . Comply with limits specified in related section.
- B. Composite Wood products must meet current CARB Airborne Toxic Control Measure (ATCM) for Composite Wood Formaldehyde Limits by Mandatory Compliance Dates as specified in Section 01 6116.

### **2.02 MANUFACTURERS**

- A. Wood Veneer Faced Doors:
  - 1. Graham Wood Doors: [www.grahamdoors.com/#sle](http://www.grahamdoors.com/#sle).
  - 2. Marshfield DoorSystems, Inc: [www.marshfielddoors.com/#sle](http://www.marshfielddoors.com/#sle).
  - 3. Oregon Door: [www.oregondoor.com/#sle](http://www.oregondoor.com/#sle).
  - 4. VT Industries, Architectural Wood Doors: [www.vtindustries.com](http://www.vtindustries.com)
  - 5. Substitutions: See Section 01 6000 - Product Requirements.

### **2.03 DOORS**

- A. Doors: Refer to drawings for locations and additional requirements.
  - 1. AWI/AWMAC/WI - Architectural Woodwork Standards (AWS); Section , Custom Grade.
  - 2. Wood Veneer Faced Doors: 5-ply unless otherwise indicated.
- B. Interior Doors: 1-3/4 inches (44 mm) thick unless otherwise indicated; flush construction.
  - 1. Provide solid core doors at each location.
  - 2. Fire Rated doors: Tested to ratings indicated on the drawings in accordance with ANSI/UL10C Positive Pressure Fire Tests of Door Assemblies: UL or WH(ITS) labeled without any visible seals when door is open.
  - 3. Wood veneer facing for field transparent finish as indicated on drawings.
  - 4. Hardboard facing with factory opaque finish as indicated on drawings.

### **2.04 DOOR AND PANEL CORES**

- A. Non-Rated Solid Core and 20 Minute Rated Doors: Type structural composite lumber core (SCLC), plies and faces as indicated.
  - 1. Screw Withdrawal, Face: 700 lbf (3100 N).
  - 2. Screw Withdrawal, Edge: 400 lbf (1780 N).
- B. Fire-Rated Doors: Mineral core type, with fire resistant composite core (FD), plies and faces as indicated above; with core blocking as required to provide adequate anchorage of hardware without through-bolting.

### **2.05 DOOR FACINGS**

- A. Veneer Facing for Transparent Finish: Red oak, veneer grade in accordance with quality standard indicated, plain sliced (flat cut), with book match between leaves of veneer, running match of spliced veneer leaves assembled on door or panel face.
  - 1. Vertical Edges: Same species as face veneer.

2. "Pair Match" each pair of doors; "Set Match" pairs of doors within 10 feet (3 m) of each other when doors are closed.
- B. Veneer Facing for Opaque Finish: Medium density overlay (MDO), in compliance with indicated quality standard.
- C. Facing Adhesive: Type I - waterproof all locations.

## **2.06 DOOR CONSTRUCTION**

- A. Fabricate doors in accordance with door quality standard specified.
- B. Prior to factory finish, cut-out and frame for glazed panels and cut-out for hardware.
  1. Bevel or ease all corners at intersections of faces with edges, top, and bottom, 1/16-inch.
  2. Doors to receive paint finish: Clear seal all surfaces including faces, edges, top, bottom, cutouts, and rabbets.
  3. Prime paint steel glass stops, edges, and astragals.
- C. Cores Constructed with stiles and rails:
  1. Bevel lock edge 1/8 in 2.
  2. Cores
    - a. Glue all edges of adjacent components. Glue entire core assemble to edges.
    - b. Block for hardware at doors having mineral or particleboard cores. Provide solid blocking for through-bolted hardware.
- D. Provide solid blocks at lock edge for hardware reinforcement.
  1. Provide solid blocking for other throughbolted hardware.
- E. Fit door edge trim to edge of stiles after applying veneer facing.
- F. Vertical Exposed Edge of Stiles - Veneer Faces: Of same species as veneer facing.
- G. Fit door edge trim to edge of stiles after applying veneer facing.
- H. Glazed Openings: Non-removable stops on non-secure side; sizes and configurations as indicated on drawings.
- I. Factory machine doors for hardware other than surface-mounted hardware, in accordance with hardware requirements and dimensions.
- J. Factory fit doors for frame opening dimensions identified on shop drawings, with edge clearances in accordance with specified quality standard.
  1. Exception: Doors to be field finished.
- K. Cut and configure exterior door edge to receive recessed weatherstripping devices.
- L. Provide edge clearances in accordance with the quality standard specified.
- M. Provide edge clearances in accordance with AWI Quality Standards Illustrated Section 1700.

## **2.07 FACTORY FINISHING - WOOD VENEER DOORS**

- A. Finish work in accordance with AWI/AWMAC/WI (AWS) or AWMAC/WI (NAAWS), Section 5 - Finishing for grade specified and as follows:
  1. Transparent:
    - a. System - 11, Polyurethane, Catalyzed.
    - b. Stain: As selected by Architect.
    - c. Sheen: Semigloss.
  2. Opaque:

- a. System - 10, UV Curable, Water-based.
  - b. Color: As selected by Architect.
  - c. Sheen: Semigloss.
- B. Factory finish doors in accordance with approved sample.
- C. Seal door top edge with color sealer to match door facing.

## 2.08 ACCESSORIES

- A. Hollow Metal Door Frames: As specified in Section 08 1113.
- B. Metal Louvers: Provide at locations indicated in the Door Schedule.
- 1. Manufacturers:
    - a. Anemostat.
    - b. Air Louver.
    - c. Substitutions: See Section 01 6000 - Product Requirements.
  - 2. Material and Finish: Roll formed steel; Hot Dipped galvanized finish at locations where doors and frames are exposed to weather, baked enamel elsewhere..
  - 3. Louver Blade: Inverted V blade, sight proof, light proof; fire rating to match rating of assembly.
  - 4. Security Louvers at exterior locations; Anemostat PLSL.
  - 5. Frame: Double Flanged style with tamper proof fasteners.
- C. Glazed Openings:
- D. Glazing Stops: Wood, of same species as door facing, butted corners; prepared for countersink style tamper proof screws.
- E. Astragals for Non-Rated Double Doors: Steel, T shaped, overlapping and recessed at face edge.
- F. Astragals for Fire-Rated Double Doors: Steel, T shaped, overlapping and recessed at face edge, specifically for double doors.

## PART 3 EXECUTION

### 3.01 EXAMINATION

- A. Verify existing conditions before starting work.
- B. Verify that opening sizes and tolerances are acceptable.
- C. Do not install doors in frame openings that are not plumb or are out-of-tolerance for size or alignment.

### 3.02 INSTALLATION

- A. Install doors in accordance with manufacturer's instructions and specified quality standard.
- 1. Install fire-rated doors in accordance with NFPA 80 requirements.
- B. Factory-Finished Doors: Do not field cut or trim; if fit or clearance is not correct, replace door.
- C. Conform to WI requirements for fit and clearance tolerances. Door clearance at head and jambs shall be 3/32-inch plus or minus 1/32-inch.
- D. Doors shall operate freely but not loosely and shall be free from rattling in closed position.
- E. Adjust width of non-rated doors by cutting equally on both jamb edges.
- 1. Trim fire-rated doors in strict compliance with fire rating limitations.



- F. Trim door height by cutting bottom edges to a maximum of 3/4 inch (19 mm).
- G. Use machine tools to cut or drill for hardware.
- H. Coordinate installation of doors with installation of frames and hardware.
- I. Coordinate installation of glazing.
- J. Install door louvers plumb and level.

**3.03 TOLERANCES**

- A. Comply with specified quality standard for fit and clearance tolerances.
- B. Comply with specified quality standard for telegraphing, warp, and squareness.

**3.04 ADJUSTING**

- A. Adjust doors for smooth and balanced door movement.
- B. Adjust closers for full closure in compliance with prevailing codes.
- C. Repair damaged and defective work and eliminate functional and visual defects. Where repair is not possible replace work. Adjust for uniform appearance. No unfinished surfaces or irregularities in completed work.
- D. Protect installed work from subsequent construction operations until Owner's acceptance. Utilize durable protective wrappings using methods which will not damage surfaces or finishes. Do not remove until Owner acceptance following move-in.

**3.05 SCHEDULE**

- A. Refer to Door and Frame Schedule appended to this section.

**END OF SECTION**

**SECTION 08 3100**  
**ACCESS DOORS AND PANELS**

**PART 1 GENERAL**

**1.01 SECTION INCLUDES**

- A. Access door and frame units, fire-rated and non-fire-rated, in wall and ceiling locations wherever required for access to enclosed spaces or equipment.

**1.02 RELATED REQUIREMENTS**

- A. Section 09 9113 - Exterior Painting: Field paint finish.
- B. Section 09 9123 - Interior Painting: Field paint finish.
- C. Division 23 - Mechanical: Mechanical and plumbing components requiring access.
- D. Division 26 - Electrical: Electrical components requiring access.

**1.03 REFERENCE STANDARDS**

- A. ITS (DIR) - Directory of Listed Products; current edition.
- B. Manufacturer's recommendations and specifications.
- C. UL (FRD) - Fire Resistance Directory; current edition.

**1.04 DESIGN REQUIREMENTS**

- A. Design Requirements: Provide door seals for access doors located in sound isolating walls or ceilings.
- B. Performance Requirements: Provide door covered access into all attic spaces and at all portions of the work to which access is necessary for periodic inspection, adjustments, or maintenance, and which is enclosed behind finish materials, including, but not limited to, valves, water hammer arrestors, mechanical units, electrical panels and outlets, equipment and systems.

**1.05 SUBMITTALS**

- A. See Section 01 3300 - Submittals, for submittal procedures.
- B. Schedule: Tabular listing of access doors and panels, indicating location, size, materials, fire rating, device or purpose for access.
- C. Product Data: Provide sizes, types, finishes, hardware, scheduled locations, and details of adjoining work.
- D. Shop Drawings: Indicate exact position of each access door and/or panel unit.
- E. Manufacturer's Installation Instructions: Indicate installation requirements for fire rated units.
- F. Project Record Documents: Record actual locations of each access unit.

**1.06 REGULATORY REQUIREMENTS**

- A. Conform to Title 24, Part 2, California Building Code for fire rated access doors.
  - 1. Provide access doors of fire rating equivalent to the fire rated assembly in which they are to be installed.

- B. Provide products listed and labeled by UL or ITS (Warnock Hersey) as suitable for the purpose specified and indicated.

### **1.07 PROJECT CONDITIONS**

- A. Coordinate the work with other work requiring access doors.

## **PART 2 PRODUCTS**

### **2.01 ACCESS DOORS AND PANELS ASSEMBLIES**

### **2.02 MANUFACTURERS**

- A. Wall and Ceiling Access Doors:
  - 1. Karp Associates, Inc: [www.karpinc.com](http://www.karpinc.com).
  - 2. Milcor by Commercial Products Group of Hart & Cooley, Inc: [www.milcorinc.com](http://www.milcorinc.com).
  - 3. J. L. Industries, [www.jlindustries.com](http://www.jlindustries.com).
  - 4. Substitutions: See Section 01 6000 - Product Requirements.

### **2.03 ACCESS DOORS AND PANELS**

- A. All Units: Factory fabricated, fully assembled units with corner joints welded, filled, and ground flush; square and without rack or warp; coordinate requirements with assemblies units are to be installed in.

### **2.04 ACCESS DOOR UNITS - WALLS AND CEILINGS**

- A. Door sizes: Unless otherwise specifically noted on drawings; smallest standard size which will permit ready access and removal of working parts requiring maintenance.
- B. Door and Frame Units: Formed steel and stainless steel where noted.
  - 1. Frames and flanges: 0.058 inch (1.5 mm) steel.
  - 2. Door panels: 0.070 inch (1.8 mm) single thickness steel sheet.
  - 3. Door/Panel Size: As indicated on the drawings.
  - 4. Hardware:
    - a. Hinges for Non-Fire-Rated Units: Concealed, constant force closure spring type.
    - b. Hinge: 175 degree stainless steel piano hinge with pin.
    - c. Latch/Lock: Cylinder lock-operated cam latch, two keys for each unit.

### **2.05 FABRICATION**

- A. Weld, fill, and grind joints to ensure flush and square unit.

### **2.06 FINISHES**

- A. General: Provide doors and/or panels of the following finishes as scheduled.
  - 1. Galvanized, hot dipped finish.
  - 2. Prime coat with alkyd primer.
  - 3. Stainless Steel Finish: No. 4 finish.

### **2.07 SOURCE QUALITY CONTROL**

- A. Certifications: Furnish each fire rated door with affixed label of Underwriters Laboratories (UL), Warnock Hersey International (WHI), or other approved independent testing laboratory and inspection service, certifying scheduled fire rating.

### **PART 3 EXECUTION**

#### **3.01 EXAMINATION**

- A. Investigate conditions requiring access, select panels of suitable type and configuration for conditions indicated.
- B. For conditions requiring access and for which panels or doors are not otherwise shown, recommend panel or door type and size for Architect's review.
- C. Verify that rough openings are correctly sized and located.

#### **3.02 INSTALLATION**

- A. Install units in accordance with manufacturer's instructions.
- B. Install frames plumb and level in openings, and secure units rigidly in place.
- C. Position units to provide convenient access to the concealed work requiring access. Avoid conflict with other building elements.

#### **3.03 SCHEDULE**

- A. Exterior Doors and Panels: Galvanized for site finishing specified in 09 9113.
- B. Interior Doors and Panels in Restrooms, Food Preparation, Locker Rooms and in ceramic tile surfaced walls wherever located: Stainless steel construction, No. 4 finish.
- C. Interior Doors and Panels in all other locations: Primed for site finishing specified in 09 9123.

**END OF SECTION**

**SECTION 08 4313**

**ALUMINUM ENTRANCES AND STOREFRONTS**

**PART 1 GENERAL**

**1.01 SECTION INCLUDES**

- A. Aluminum-framed storefront, with vision glass.
- B. Infill panels of metal and glass.
- C. Aluminum doors and frames.
- D. Perimeter sealant.
- E. Section also includes Contractor's responsibility to assume role of "Responsible Party" for NFRC label testing and inspection "Certified Project Option", to obtain Fenestration Acceptance Requirements certification required for occupancy permit. Refer to California Energy Code Section 110.6.

**1.02 RELATED REQUIREMENTS**

- A. Section 01 6116 - Volatile Organic Compound (VOC) Restrictions.
- B. Section 07 2500 - WEATHER BARRIERS: Sealing framing to weather barrier installed on adjacent construction.
- C. Section 07 9200 - Joint Sealants: Sealing joints between frames and adjacent construction.
- D. Section 08 5113 - Aluminum Windows.
- E. Section 08 7100 - Door Hardware: Hardware items other than specified in this section.
- F. Section 08 8000 - Glazing: Glass and glazing accessories.

**1.03 REFERENCE STANDARDS**

- A. 36 CFR 1191 - Americans with Disabilities Act Accessibility Guidelines for Buildings and Facilities; Final Rule; Federal Register, July 26, 1991; updated 2010.
- B. AAMA CW-10 - Care and Handling of Architectural Aluminum From Shop to Site; 2015.
- C. AAMA 501.2 - Field Check of Metal Storefronts, Curtain Walls, and Sloped Glazing Systems for Water Leakage; 2009.
- D. AAMA 609 & 610 - Cleaning and Maintenance Guide for Architecturally Finished Aluminum (Combined Document); 2015.
- E. AAMA 611 - Voluntary Specification for Anodized Architectural Aluminum; 2012.
- F. AAMA 1503 - Voluntary Test Method for Thermal Transmittance and Condensation Resistance of Windows, Doors and Glazed Wall Sections; 2009.
- G. AAMA 2605 - Voluntary Specification, Performance Requirements and Test Procedures for Superior Performing Organic Coatings on Aluminum Extrusions and Panels; 2013.
- H. ASCE 7 - Minimum Design Loads for Buildings and Other Structures; 2010, with 2013 Supplements and Errata.
- I. ASTM A36/A36M - Standard Specification for Carbon Structural Steel; 2014.
- J. ASTM A123/A123M - Standard Specification for Zinc (Hot-Dip Galvanized) Coatings on Iron and Steel Products; 2015.

- K. ASTM B209 - Standard Specification for Aluminum and Aluminum-Alloy Sheet and Plate; 2014.
- L. ASTM B209M - Standard Specification for Aluminum and Aluminum-Alloy Sheet and Plate [Metric]; 2014.
- M. ASTM B221 - Standard Specification for Aluminum and Aluminum-Alloy Extruded Bars, Rods, Wire, Profiles, and Tubes; 2014.
- N. ASTM B221M - Standard Specification for Aluminum and Aluminum-Alloy Extruded Bars, Rods, Wire, Profiles, and Tubes [Metric]; 2013.
- O. ASTM E283 - Standard Test Method for Determining the Rate of Air Leakage Through Exterior Windows, Curtain Walls, and Doors Under Specified Pressure Differences Across the Specimen; 2004 (Reapproved 2012).
- P. ASTM E330/E330M - Standard Test Method for Structural Performance of Exterior Windows, Doors, Skylights and Curtain Walls by Uniform Static Air Pressure Difference; 2014.
- Q. ASTM E331 - Standard Test Method for Water Penetration of Exterior Windows, Skylights, Doors, and Curtain Walls by Uniform Static Air Pressure Difference; 2000 (Reapproved 2009).
- R. California Code of Regulations, Title 24, Part 11 California Green Building Standards Code, "CAL-Green", current edition.
- S. California Energy Code "Building Energy Efficiency Standards", 2013.
- T. California Energy Code "Reference Nonresidential Appendix NA7", 2013.
- U. California Code of Regulations, Title 24, Part 2, California Building Code (CBC), International Building Code, with California Amendments, current edition.
- V. SSPC-Paint 20 - Zinc-Rich Primers (Type I, "Inorganic," and Type II, "Organic"); 2002 (Ed. 2004).
- W. SSPC-Paint 25 - Zinc Oxide, Alkyd, Linseed Oil Primer for Use Over Hand Cleaned Steel, Type I and Type II; Society for Protective Coatings; 1997 (Ed. 2004).

#### **1.04 ADMINISTRATIVE REQUIREMENTS**

- A. Coordinate with installation of other components that comprise the exterior enclosure.
- B. Preinstallation Meeting: Conduct a preinstallation meeting two weeks before starting work of this section; require attendance by all affected installers.
  - 1. Meet at Project site with Installer, installer of each component of associated work, installers of substrate construction to receive this work, installers of other work that must precede or follow storefront work (including mechanical work if any), Architect/Owner, storefront system manufacturer's representative, and other representatives directly concerned with performance of the Work, including (where applicable) Owner's insurers, test agencies, and governing authorities. Objectives to include:
    - a. Review preparation and installation procedures and coordinating and scheduling required with related work.
    - b. Review methods and procedures related to storefront and glazing work.
    - c. Review structural loading limitations of new storefront.
    - d. Review storefront systems requirements (drawings, specifications, and other contract documents).

- e. Review required submittals, both completed and yet to be completed, including deferred approvals, if any.
- f. Review and finalize construction schedule related to storefront work and verify availability of materials, Installer's personnel, equipment, and facilities needed to make progress and avoid delays.
- g. Review required inspection, testing, certifying, and material usage accounting procedures.
- h. Review weather and forecasted weather conditions and procedures for coping with unfavorable conditions, including provision of temporary enclosure of partially completed or occupied spaces.
- i. Record discussion of conference, including decisions and agreements (or disagreements) reached, and furnish copy of record to each party attending. If substantial disagreements exist at conclusion of conference, determine how disagreements will be resolved and set date for reconvening conference.
- j. Review notification procedures for weather or non-working days.

#### **1.05 SUBMITTALS**

- A. See Section 01 3300 - Submittals, for submittal procedures.
- B. Provide submittals coordinated with submittals for related sections referenced in this Section for simultaneous review.
- C. Division of the State Architect Deferred Approval Submittal Requirements:
  - 1. This section specifies work that is a Division of the State Architect (DSA) deferred approval item. All Engineering calculations and Shop Drawings require review and approval by the Division of the State Architect prior to fabrication or installation. Deferred Approval review provisions of Section 01 3300 apply to the submittals of this section.
  - 2. Submit items for deferred approval complete with all structural calculations, test data and information as specified or as subsequently required by the reviewing agency, including engineering stamps and signatures as required. Architect shall submit to DSA only following Architect/Engineer review.
    - a. The Architect will not approve deferred approval submittals until they are approved by DSA.
  - 3. No work or fabrication shall begin until DSA approved submittals are distributed to the Contractor.
  - 4. Contractor is notified that significant lead time is required for deferred approval review by DSA and shall schedule submittals accordingly. No extension of Contract Time will be allowed for delays incurred by deferred approval review.
    - a. The Architect is not responsible for DSA delays in deferred approval review.
  - 5. Submit Certification of Compliance and all other documentation as required by Division of the State Architect.
  - 6. Make all changes and revisions required by Division of State Architect to obtain approval at no additional costs or extension of time.
- D. Product Data: Provide component dimensions, describe components within assembly, anchorage and fasteners, glass and infill, door hardware, and internal drainage details.
- E. VOC Submittals:
  - 1. Product Data - VOC Limits: For adhesives sealants, fillers and primers, documentation including printed statement of VOC contents, demonstrate compliance with limits specified in Section 01 6116.
- F. Shop Drawings: Indicate system dimensions, framed opening requirements and tolerances, affected related work, expansion and contraction joint location and details, and field welding required.

1. Shop drawings shall include project-specific integrations to surrounding cladding and waterproofing components, including items specified in other sections.
  2. Provide installation instructions and isometric details indicating how system components will be installed and sealed watertight.
- G. Design Data: Provide framing member structural and physical characteristics, engineering calculations, and dimensional limitations.
- H. Samples: Submit two samples 12x12 inches (\_\_\_\_x\_\_\_\_ mm) in size illustrating finished aluminum surface, glass, glazing materials.
- I. Manufacturer's Certificate: Certify that the products supplied meet or exceed the specified requirements.
- J. Field Quality Control Submittals: Report of field testing for water penetration and air leakage.
- K. Warranty: Submit manufacturer warranty and ensure forms have been completed in Owner's name and registered with manufacturer.

#### **1.06 INFORMATIONAL SUBMITTALS**

- A. Qualification Data: For qualified Installer and testing agency.
- B. Certificate of Acceptance: Refer to California Energy Code Section 110.6.
1. Submit Certificate of Acceptance certifying that the fenestration product meets the required acceptance requirements, completed, signed and submitted to the enforcement agency, with copies to Owner and Architect.
- C. Seismic Qualification Certificates: For aluminum-framed systems, accessories, and components, from manufacturer.
1. Basis for Certification: Indicate whether withstand certification is based on actual test of assembled components or on calculation.
- D. Welding certificates.
- E. Preconstruction Test Reports: For sealant.
- F. Product Test Reports: Based on evaluation of comprehensive tests performed by a qualified testing agency, for aluminum-framed systems, indicating compliance with performance requirements. For each system provide test reports with shop drawings
- G. Source quality-control reports.
1. Field quality-control reports.
- H. NFRC 100 Label Certificate: Submit proof of testing of site-built assembly and compliance with NFRC 100. Manufacturer certificates or factory tests are not acceptable for this requirement.
- I. Warranties: Sample of special warranties.

#### **1.07 QUALITY ASSURANCE**

- A. Manufacturer Qualifications: Company specializing in performing work of type specified and with at least three years of documented experience.
- B. Installer Qualifications: Company specializing in performing work of type specified and with at least three years of documented experience.
- C. Engineering Responsibility: Prepare data for aluminum-framed systems, including Shop Drawings, based on testing and engineering analysis of manufacturer's standard units in systems similar to those indicated for this Project.



- D. NFRC Compliance: Completed site-built assembly shall conform to NFRC 100 requirements and be tested and labeled in accordance with that standard.
- E. Testing Agency Qualifications: Qualified according to ASTM E 699 for testing indicated.
- F. Product Options: Information on Drawings and in Specifications establishes requirements for systems' aesthetic effects and performance characteristics. Aesthetic effects are indicated by dimensions, arrangements, alignment, and profiles of components and assemblies as they relate to sightlines, to one another, and to adjoining construction. Performance characteristics are indicated by criteria subject to verification by one or more methods including preconstruction testing, field testing, and in-service performance.
  - 1. Do not revise intended aesthetic effects, as judged solely by Architect, except with Architect's approval. If revisions are proposed, submit comprehensive explanatory data to Architect for review.
- G. Accessible Entrances: Comply with applicable provisions in the U.S. Architectural & Transportation Barriers Compliance Board's ADA-ABA Accessibility Guidelines and ICC/ANSI A117.1.

#### **1.08 DELIVERY, STORAGE, AND HANDLING**

- A. Handle products of this section in accordance with AAMA CW-10.
- B. Protect finished aluminum surfaces with wrapping. Do not use adhesive papers or sprayed coatings that bond to aluminum when exposed to sunlight or weather.

#### **1.09 FIELD CONDITIONS**

- A. Field Measurements: Verify actual locations of structural supports for aluminum-framed systems by field measurements before fabrication and indicate measurements on Shop Drawings.
- B. Established Dimensions: Where field measurements cannot be made without delaying the Work, establish dimensions and proceed with fabricating glazed aluminum curtain-wall systems correspond to established dimensions.
- C. Do not install sealants when ambient temperature is less than 40 degrees F (5 degrees C). Maintain this minimum temperature during and 48 hours after installation.

#### **1.10 WARRANTY**

- A. See Section 01 7000 - Contract Closeout, for additional warranty requirements.
- B. Special Warranty: Manufacturer's standard form in which manufacturer agrees to repair or replace components of aluminum-framed systems that do not comply with requirements or that fail in materials or workmanship within specified warranty period.
  - 1. Failures include, but are not limited to, the following:
    - a. Structural failures including, but not limited to, excessive deflection.
    - b. Noise or vibration caused by thermal movements.
    - c. Deterioration of metals and other materials beyond normal weathering.
    - d. Adhesive or cohesive sealant failures.
    - e. Water leakage through fixed glazing and framing areas.
    - f. Failure of operating components.
- C. Correct defective Work within a five year period after Date of Substantial Completion.
- D. Provide ten year manufacturer warranty against excessive degradation of exterior finish. Include provision for replacement of units with excessive fading, chalking, or flaking.

## **PART 2 PRODUCTS**

### **2.01 DESIGN REQUIREMENTS**

- A. VOC Limits for adhesives sealants, fillers, coatings and primers. Comply with limits specified in Section 01 6116.
- B. Assume role of "Responsible Party" for NFRC label testing and inspection "Certified Project Option". Make all arrangements necessary to perform required testing of site-built assembly and obtain NFRC label as described in NFRC 100.5.6. Contractor is responsible to obtain, including payment of all required fees, a label certificate for the site built fenestration system meeting requirements of California Energy Code 2013 Section 10-111(a)2 as described in California Energy Code Section 110.6.
- C. Thermally Broken: All components, including doors, to be thermally broken with continuous resilient elastomeric extrusions.
- D. Weather Resistance:
  - 1. Design shall provide waterproofing and an air-vapor retarder that is continuous at all penetrations, transitions, and other conditions. System shall integrate with the building's waterproofing and air-vapor-retarder system to provide a weathertight transition. System shall not allow the movement of the interior or exterior air to flow vertically within the assembly. Methods employed to prevent internal air movement shall not restrict water flow channels or prevent thermal movement of the frames.
  - 2. Water penetration into the system is acceptable only if all of the following conditions are satisfied; any other water penetration is considered water leakage and is unacceptable:
    - a. Water is immediately contained and drained to the exterior.
    - b. There is no wetting of a surface that could be damaged by moisture or that would be visible to building occupants.
    - c. There would be no staining or other damage to completed building or its furnishings.
    - d. This definition of water leakage governs over the other definitions that may appear in referenced documents.
  - 3. Provide internal gutters and weep systems to collect and drain water leakage and condensation to the exterior at the sill of each opening. Glazing assemblies shall have on isolated gutter cavity at each glass perimeter so the leakage is confined to and wept from the opening of origin. Glazing assemblies shall have continuous spliced gutters at mullions splices, with sealed and caps at termination conditions. Systems shall not direct water to contact edges of insulating glass units. Prevent water infiltration at weeps. Coordinate gutter and weep systems with other sections.
- E. Sound Transmission Class (STC): Rated for not less than 30 STC when tested for laboratory sound transmission loss according to ASTM E 90 and determined by ASTM E 413.
  - 1. Locations per Drawings, coordinate with Section 08 8000 for IGU selection, values as scheduled or as shown on Drawings:

### **2.02 MANUFACTURERS**

- A. Source Limitations for Aluminum-Framed Systems: Obtain from single source from single manufacturer, same as that specified in Section 08 4413 for Glazed Aluminum Curtain Walls.
- B. Aluminum-Framed Storefront and Doors:
  - 1. Oldcastle BuildingEnvelope; Series 3000-6000 Thermal Multiplane:  
[www.oldcastlebe.com/#sle](http://www.oldcastlebe.com/#sle).
- C. Substitutions: See Section 01 6000 - Product Requirements.

## 2.03 STOREFRONT

- A. Aluminum-Framed Storefront: Factory fabricated, factory finished aluminum framing members with infill, and related flashings, anchorage and attachment devices.
1. Glazing Position: Back-Set.
  2. Water Leakage Test Pressure Differential: 12 lbf/sq ft (575 Pa).
  3. Air Infiltration Test Pressure Differential: 6.24 psf (300 Pa).
  4. Finish: Superior performing organic coatings.
    - a. Factory finish all surfaces that will be exposed in completed assemblies.
    - b. Touch-up surfaces cut during fabrication so that no natural aluminum is visible in completed assemblies, including joint edges.
  5. Fabrication: Joints and corners flush, hairline, and weatherproof, accurately fitted and secured; prepared to receive anchors and hardware; fasteners and attachments concealed from view; reinforced as required for imposed loads.
  6. Construction: Eliminate noises caused by wind and thermal movement, prevent vibration harmonics, and prevent "stack effect" in internal spaces.
  7. System Internal Drainage: Drain to the exterior by means of a weep drainage network any water entering joints, condensation occurring in glazing channel, and migrating moisture occurring within system.
  8. Expansion/Contraction: Provide for expansion and contraction within system components caused by cycling temperature range of 170 degrees F (95 degrees C) over a 12 hour period without causing detrimental effect to system components, anchorages, and other building elements.
  9. Movement: Allow for movement between storefront and adjacent construction, without damage to components or deterioration of seals.
  10. Perimeter Clearance: Minimize space between framing members and adjacent construction while allowing expected movement.
  11. Air and Vapor Seal: Maintain continuous air barrier and vapor retarder throughout assembly, primarily in line with inside pane of glazing and inner sheet of infill panel and heel bead of glazing compound.
- B. Performance Requirements:
1. Structural Loads:
    - a. Wind Loads: As indicated on the Drawings.
    - b. Seismic Loads: As indicated on the Drawings.
    - c. Other Design Loads: As indicated on Drawings.
  2. Wind Loads: Design and size components to withstand the specified load requirements without damage or permanent set, when tested in accordance with ASTM E330/E330M, using loads 1.5 times the design wind loads and 10 second duration of maximum load.
    - a. Member Deflection: Limit member deflection to flexure limit of glass in any direction, with full recovery of glazing materials.
  3. Water Penetration Resistance: No uncontrolled water as described in paragraph "Weather Resistance" above, when tested in accordance with ASTM E331 at pressure differential of 12 lbf/sq ft (575 Pa).
  4. Air Leakage Laboratory Test: Maximum of 0.06 cu ft/min sq ft (0.3 L/sec sq m) of wall area, when tested in accordance with ASTM E283 at 6.27 psf (300 Pa) pressure differential across assembly.
  5. Thermally Broken: All components, including doors, to be thermally broken with continuous resilient elastomeric extrusions.
  6. Condensation Resistance Factor of Framing: 50, minimum, measured in accordance with AAMA 1503.
  7. Air Infiltration: Limit air infiltration through assembly to 0.06 cu ft/min/sq ft (0.3 L/s/sq m) of wall area, measured at specified differential pressure across assembly in accordance with ASTM E283.

8. Failure defined to include any of the following:
  - a. Deflection exceeding specified limits.
  - b. Water penetration, including condensation, in excess of that specified in this section.
  - c. Thermal stresses transferring to building structure.
  - d. Framing members transferring stresses, including those caused by thermal and structural movements to glazing.
  - e. Noise or vibration created by wind and by thermal and structural movements.
  - f. Loosening or weakening of fasteners, attachments, and other components.
  - g. Sealant failure.
  - h. Failure of operating units.

#### **2.04 COMPONENTS**

- A. Aluminum Framing Members: Tubular aluminum sections, drainage holes and internal weep drainage system.
  1. Glazing Stops: Flush.
  2. Cross-Section: As indicated on drawings.
- B. Infill Panels: Insulated, aluminum sheet face and back, with edges formed to fit glazing channel and sealed.
  1. Finish: Same as storefront.

#### **2.05 GLAZING**

- A. Glazing: As specified in Division 08 Section "Glazing."
- B. Glazing Gaskets: Manufacturer's standard compression types; replaceable, molded or extruded, of profile and hardness required to maintain watertight seal.
- C. Spacers and Setting Blocks: Manufacturer's standard elastomeric type.
- D. Bond-Breaker Tape: Manufacturer's standard TFE-fluorocarbon or polyethylene material to which sealants will not develop adhesion.
- E. Glazing Sealants: For structural-sealant-glazed systems, as recommended by manufacturer for joint type, and as follows:
  1. VOC Limits, for adhesives sealants, fillers and primers. Comply with limits specified in Section 01 6116.
  2. Weatherseal Sealant: If structural sealant is not the weatherseal sealant, provide ASTM C 920 for Type S, Grade NS, Class 25, Uses NT, G, A, and O; single-component neutral-curing formulation that is compatible with structural sealant and other system components with which it comes in contact; recommended by structural-sealant, weatherseal-sealant, and aluminum-framed-system manufacturers for this use.
    - a. Color: As selected by Architect.

#### **2.06 ENTRANCE DOOR SYSTEMS**

- A. Stile-and-Rail Type Entrance Doors for manual-swing operation: Provide storefront manufacturer's heavy duty type complying with all of the following:
  1. Door corner construction shall consist of mechanical clip fastening, SIGMA deep penetration and fillet welds.
  2. Glazing: Fabricate doors to facilitate replacement of glass or aluminum panels, without disassembly of stiles and rails. Provide beveled, snap-on, extruded-aluminum stops and preformed gaskets with exterior stops anchored for non-removal.
  3. Equip each door leaf with an adjusting mechanism located in the top rail near the lock stile, which provides for minor clearance adjustments after installation.
  4. Door Construction: Minimum 2 inch overall thickness, with minimum 0.125-inch-(3.2-mm-) thick, extruded-aluminum tubular rail and stile members. Mechanically

fasten corners with reinforcing brackets that are deeply penetrated and fillet welded or that incorporate concealed tie rods.

5. Thermal Construction: High-performance plastic connectors separate aluminum members exposed to the exterior from members exposed to the interior.
6. Door Design: Wide stile; 5-inch (127-mm) nominal width.
  - a. Stile and Rail dimensions as indicated.
  - b. Accessible Doors: Smooth surfaced for width of door in area within 10 inches (255 mm) above floor or ground plane.

B. Entrance Door Hardware: As specified in Division 08 Section "Door Hardware."

## 2.07 VENTING WINDOWS

- A. Aluminum Windows: Manufacturer's standard units, complying with AAMA/WDMA/CSA 101/I.S.2/A440, with self-flashing mounting fins, and as follows:
  1. AA 900 ISO WEB. Compatible with storefront perimeter frame.
  2. Window Type: As indicated on Drawings.
  3. Minimum Performance Class: Match criteria specified for Storefront.
  4. Minimum Performance Grade: Match criteria specified for Storefront..
  5. Aluminum Extrusions: ASTM B 221 (ASTM B 221M), alloy and temper recommended by manufacturer for strength, corrosion resistance, and application of required finish, but not less than 0.064-inch (1.63-mm) thickness at any location for main frame and sash members.
    - a. Thermally Improved Construction: Fabricate window units with an integral, concealed, low-conductance thermal barrier; located between exterior materials and window members exposed on interior side; in a manner that eliminates direct metal-to-metal contact.
  6. Mullions: Between adjacent windows where occurring, fabricated of extruded aluminum matching finish of window units.
  7. Fasteners, Anchors, and Clips: Nonmagnetic stainless steel, aluminum, or other noncorrosive material, compatible with aluminum window members, trim, hardware, anchors, and other components of window units. Fasteners shall not be exposed, except for attaching hardware.
    - a. Reinforcement: Where fasteners screw-anchor into aluminum less than 0.128 inch (3.26 mm) thick, reinforce interior with aluminum or nonmagnetic stainless steel to receive screw threads, or provide standard, noncorrosive, pressed-in, spline grommet nuts.
  8. Hardware: Manufacturer's standard; of stainless steel, or bronze; including the following:
    - a. Cam-action sweep sash lock and keeper at meeting rails.
    - b. Pole-operated, cam-action locking device on meeting rail where rail is more than 72 inches (1830 mm) above floor.
    - c. Operator Pole: Provide one pole for each room having window operators more than 72 inches (1830 mm) above floor.
    - d. Steel or bronze operating arms.
    - e. Concealed lock operable with hex key at locations indicated in drawings to be lockable.
  9. Weather Stripping: Woven-pile weather stripping of wool, polypropylene, or nylon pile and resin-impregnated backing fabric; complying with AAMA 701/702.

## 2.08 MATERIALS

- A. Extruded Aluminum: ASTM B221 (ASTM B221M). 6063 alloy, T5 temper.
- B. Sheet Aluminum: ASTM B209 (ASTM B209M).
- C. Fasteners: Stainless steel.

- D. Exposed Flashings: Aluminum sheet, 20 gage, 0.032 inch (0.81 mm) minimum thickness; finish to match framing members.
  - 1. Break shapes as indicated, as recommended by manufacturer, and as required to fully enclosed and seal system.
- E. Concealed Flashings: Stainless steel, 26 gage, 0.0187 inch (0.48 mm) minimum thickness.
- F. Sill Flashing Sealant: Elastomeric, silicone or polyurethane, compatible with flashing material.
- G. Sealant for Setting Thresholds: Non-curing butyl type.
- H. Concealed Flashings: 0.018 inch (0.5 mm) thick stainless steel, dead soft, as selected by manufacturer for compatibility with other components.
- I. Perimeter Sealant: Silicone, as specified in Section 07 9005.
- J. Glazing Gaskets: Type to suit application to achieve weather, moisture, and air infiltration requirements.
- K. Glazing Accessories: As specified in Section 08 8000.
- L. Shop and Touch-Up Primer for Steel Components: SSPC-Paint 25, zinc oxide, alkyd, linseed oil primer.
- M. Touch-Up Primer for Galvanized Steel Surfaces: SSPC-Paint 20, zinc rich.
- N. Protective Backing Paint: Bituminous type, emulsified asphalt, ASTM D1187.

## **2.09 FINISHES**

- A. Superior Performing Organic Coatings System: Polyvinylidene fluoride (PVDF) multi-coat superior performing organic coatings system complying with AAMA 2605, including at least 70 percent PVDF resin, and at least 80 percent of aluminum extrusion and panels surfaces having minimum total dry film thickness (DFT) of 1.2 mils, 0.0012 inch (0.030 mm).
  - 1. Manufacturers:
    - a. PPG Metal Coatings; Duranar: [www.ppgmetalcoatings.com/#sle](http://www.ppgmetalcoatings.com/#sle).
    - b. Sherwin-Williams Company; SHER-NAR 5000: [oem.sherwin-williams.com/#sle](http://oem.sherwin-williams.com/#sle).
    - c. Valspar; Fluropon: [www.valsparcoilextrusion.com/#sle](http://www.valsparcoilextrusion.com/#sle).
    - d. Substitutions: See Section 01 6000 - Product Requirements.
- B. Color(s) as shown on drawings:
- C. Touch-Up Materials: As recommended by coating manufacturer for field application.

## **2.10 HARDWARE**

- A. Other Door Hardware: As specified in Section 08 7100.

## **2.11 FABRICATION**

- A. General: Fabricate aluminum entrance and storefront components to designs, sizes and thickness indicated, and to comply with specified standards. Sizes and profile requirements are indicated on the drawings.
- B. Prefabrication: Complete fabrication, assembly, finishing, hardware application, and other work before shipment to Project site. Disassemble components only where necessary for shipment and installation.
  - 1. Perform fabrication operations, including cutting, fitting, forming, drilling and grinding of metal work to prevent damage to exposed finish surfaces. Complete these operations for hardware prior to application of finishes.

2. Do not drill and tap for surface-mounted hardware items until time of installation at Project site.
- C. Framing Members, General: Fabricate components that, when assembled, have the following characteristics:
  1. Profiles that are sharp, straight, and free of defects or deformations.
  2. Accurately fitted joints with ends coped or mitered.
  3. Means to drain water passing joints, condensation within framing members, and moisture migrating within the system to exterior.
  4. Physical and thermal isolation of glazing from framing members.
  5. Accommodations for thermal and mechanical movements of glazing and framing to maintain required glazing edge clearances.
  6. Provisions for field replacement of glazing from interior for vision glass and exterior for spandrel glazing or metal panels.
  7. Fasteners, anchors, and connection devices that are concealed from view to greatest extent possible.
- D. Continuity: Maintain accurate relation of planes and angles with hairline fit of contacting members. Fabricate curved members to true shapes as shown on drawings, segmented or faceted curves are not acceptable. Fabricate components with minimum clearances and shim spacing around perimeter of assembly, while enabling installation and dynamic movement of perimeter seal.
- E. Accurately fit and secure joints and corners. Make joints flush, hairline, and weatherproof.
- F. Prepare components to receive anchor devices. Fabricate anchors.
- G. Welding: Comply with AWS recommendations. Grind exposed welds smooth to remove weld spatter and welding oxides. Restore mechanical finish.
  1. Welding behind finished surfaces shall be performed to minimize distortion and discoloration on the finished surface.
- H. Reinforcing: Install reinforcing as required for hardware, performance requirements, sag resistance and rigidity.
- I. Dissimilar Metals: Separate dissimilar metals and concealed metal surfaces that will be in contact with cementitious materials with bituminous paint, suitable sealant, elastomeric tape, or gasket between the surfaces. Do not use coatings containing lead.
- J. Reinforce components internally for door hardware and door operators.
- K. Reinforce framing members for imposed loads.
- L. Finishing: Apply factory finish to all surfaces that will be exposed in completed assemblies.
  1. Touch-up surfaces cut during fabrication so that no natural aluminum is visible in completed assemblies, including joint edges.
- M. After fabrication, clearly mark components to identify their locations in Project according to Shop Drawings.

## **2.12 OPERABLE UNIT FABRICATION**

- A. Entrance Door Frames: Reinforce as required to support loads imposed by door operation and for installing entrance door hardware.
  1. At exterior doors, provide compression weather stripping at fixed stops.
  2. At interior doors, provide silencers at stops to prevent metal-to-metal contact. Install three silencers on strike jamb of single-door frames and two silencers on head of frames for pairs of doors.
- B. Entrance Doors: Reinforce doors as required for installing entrance door hardware.

1. At pairs of exterior doors, provide sliding-type weather stripping retained in adjustable strip and mortised into door edge.
2. At exterior doors, provide weather sweeps applied to door bottoms.
- C. Entrance Door Hardware Installation: Factory install entrance door hardware to the greatest extent possible. Cut, drill, and tap for factory-installed entrance door hardware before applying finishes.
- D. Operable Window Frames: Reinforce as required to support loads imposed by window operation and for installing window hardware.
  1. Provide compression weather stripping at fixed stops.
- E. Operable Windows: Reinforce as required for installing hardware.
  1. At pairs of windows, provide sliding-type weather stripping retained in adjustable strip

### **PART 3 EXECUTION**

#### **3.01 EXAMINATION**

- A. Verify, with installer present, dimensions, tolerances, and method of attachment with other work.
- B. Verify that wall openings and adjoining air and vapor seal materials are ready to receive work of this section.
- C. Proceed with installation only after unsatisfactory conditions have been corrected.

#### **3.02 INSTALLATION**

- A. Install wall system in accordance with manufacturer's instructions.
  1. Do not install damaged components.
- B. Attach to structure to permit sufficient adjustment to accommodate construction tolerances and other irregularities.
- C. Provide alignment attachments and shims to permanently fasten system to building structure.
- D. Align assembly plumb and level, free of warp or twist. Maintain assembly dimensional tolerances, aligning with adjacent work.
- E. Provide thermal isolation where components penetrate or disrupt building insulation.
- F. Install sill and perimeter flashings. Turn up ends and edges; seal to adjacent work to form water tight dam.
- G. Install components to drain water passing joints, condensation occurring within framing members, and moisture migrating within the system to exterior.
- H. Where fasteners penetrate sill flashings, make watertight by seating and sealing fastener heads to sill flashing.
- I. Coordinate attachment and seal of perimeter air and vapor barrier materials.
- J. Pack fibrous insulation in shim spaces at perimeter of assembly to maintain continuity of thermal barrier.
- K. Set thresholds in bed of sealant and secure.
- L. Install glass and infill panels in accordance with Section 08 8000, using glazing method required to achieve performance criteria.



- M. Install perimeter sealant in accordance with Section 07 9200.
- N. Touch-up minor damage to factory applied finish; replace components that cannot be satisfactorily repaired.

**3.03 OPERABLE UNITS**

- A. Install operable units level and plumb, securely anchored, and without distortion. Adjust weather-stripping contact and hardware movement to produce proper operation, weathertight enclosure and tight fit at weather stripping.
- B. Entrance Doors: Field-Installed Entrance Door Hardware: Install surface-mounted entrance door hardware according to entrance door hardware manufacturers' written instructions using concealed fasteners to greatest extent possible.

**3.04 TOLERANCES**

- A. Maximum Variation from Plumb: 0.06 inch per 3 feet (1.5 mm per m) non-cumulative or 0.06 inch per 10 feet (1.5 mm per 3 m), whichever is less.
- B. Maximum Misalignment of Two Adjoining Members Abutting in Plane: 1/32 inch (0.8 mm).

**3.05 FIELD QUALITY CONTROL**

- A. Provide services of storefront manufacturer's field representative to observe for proper installation of system and submit report.
- B. Water-Spray Test: Provide water spray quality test of installed storefront components in accordance with AAMA 501.2 during construction process and before installation of interior finishes.
  - 1. Perform a minimum of two tests in each designated area as directed by Architect.
  - 2. Conduct tests in each area prior to 10 percent and 50 percent completion of this work.
- C. Repair or remove work if test results and inspections indicate that it does not comply with specified requirements.
- D. Additional testing and inspecting, at Contractor's expense, will be performed to determine compliance of replaced or additional work with specified requirements.
- E. Aluminum-framed assemblies will be considered defective if they do not pass tests and inspections. Should failure occur, Contractor shall test one additional are for each failed location
- F. Prepare test and inspection reports.
- G. Fenestration Acceptance Requirements: Refer to California Energy Code Section 110.6.
  - 1. Before an occupancy permit is granted, site-built fenestration products in other than low-rise residential buildings shall be certified as meeting the Acceptance Requirements for Code Compliance, as specified in the Reference Nonresidential Appendix NA7 to ensure that site-built fenestration meet Standards requirements, including a matching label certificate for product(s) installed and be readily accessible at the project location.
  - 2. Contractor is responsible to prepare and obtain a Certificate of Acceptance certifying that the fenestration product meets the acceptance requirements, completed, signed and submitted to the enforcement agency, including payment of all fees, with copies to Owner and Architect.

**3.06 ADJUSTING**

- A. Adjust operating hardware and sash for smooth operation.

- B. Provide window operating poles in each room having operable hardware more than 72 inches (1830 mm) above floor.

**3.07 CLEANING**

- A. Remove protective material from pre-finished aluminum surfaces.
  - 1. Wash down surfaces with a solution of mild detergent in warm water, applied with soft, clean wiping cloths, and take care to remove dirt from corners and to wipe surfaces clean.
  - 2. Upon completion of installation, thoroughly clean aluminum surfaces in accordance with AAMA 609 & 610.
- B. Remove excess sealant by method acceptable to sealant manufacturer and which will not damage pre-finished aluminum surfaces.

**3.08 PROTECTION**

- A. Protect installed products from damage until Date of Substantial Completion.
- B. Touch-up minor damage to factory applied finish, no exposed unfinished aluminum allowed in finish work; replace components that cannot be satisfactorily repaired.

**END OF SECTION**

**SECTION 08 4413**  
**ALUMINUM CURTAIN WALL**

**PART 1 GENERAL**

**1.01 SECTION INCLUDES**

- A. Aluminum-framed curtain wall, with vision glazing and glass and metal infill panels.
- B. Section also includes Contractor's responsibility to assume role of "Responsible Party" for NFRC label testing and inspection "Certified Project Option", to obtain Fenestration Acceptance Requirements certification required for occupancy permit. Refer to California Energy Code Section 110.6.

**1.02 RELATED REQUIREMENTS**

- A. Section 01 6116 - Volatile Organic Compound (VOC) Restrictions.
- B. Section 03 3000 - Cast-in-Place Concrete: Weld plates embedded in concrete for attachment of anchors.
- C. Section 05 1200 - Structural Steel Framing: Steel attachment members.
- D. Section 05 5000 - METAL FABRICATIONS: Steel attachment devices.
- E. Section 07 2500 - WEATHER BARRIERS: Sealing framing to weather barrier installed on adjacent construction.
- F. Section 07 8400 - Firestopping: Firestop at system junction with structure.
- G. Section 07 9200 - Joint Sealants: Sealing joints between frames and adjacent construction.
- H. Section 08 4313 - Aluminum-Framed Storefronts: Entrance framing and doors.
- I. Section 08 5113 - Aluminum Windows: Operable sash within glazing system.
- J. Section 08 8000 - Glazing.

**1.03 REFERENCE STANDARDS**

- A. AAMA CW-10 - Care and Handling of Architectural Aluminum From Shop to Site; 2015.
- B. AAMA 501.2 - Field Check of Metal Storefronts, Curtain Walls, and Sloped Glazing Systems for Water Leakage; 2009.
- C. AAMA 501.4 - Recommended Static Test Method for Evaluating Curtain Wall and Storefront Systems Subjected to Seismic and Wind Induced Interstory Drifts; 2009.
- D. AAMA 503 - Voluntary Specification for Field Testing of Newly Installed Storefronts, Curtain Walls and Sloped Glazing Systems; 2014.
- E. AAMA 609 & 610 - Cleaning and Maintenance Guide for Architecturally Finished Aluminum (Combined Document); 2015.
- F. AAMA 2605 - Voluntary Specification, Performance Requirements and Test Procedures for Superior Performing Organic Coatings on Aluminum Extrusions and Panels; 2013.
- G. ASTM A36/A36M - Standard Specification for Carbon Structural Steel; 2014.
- H. ASTM A123/A123M - Standard Specification for Zinc (Hot-Dip Galvanized) Coatings on Iron and Steel Products; 2015.

- I. ASTM B209 - Standard Specification for Aluminum and Aluminum-Alloy Sheet and Plate; 2014.
- J. ASTM B209M - Standard Specification for Aluminum and Aluminum-Alloy Sheet and Plate [Metric]; 2014.
- K. ASTM B221 - Standard Specification for Aluminum and Aluminum-Alloy Extruded Bars, Rods, Wire, Profiles, and Tubes; 2014.
- L. ASTM B221M - Standard Specification for Aluminum and Aluminum-Alloy Extruded Bars, Rods, Wire, Profiles, and Tubes [Metric]; 2013.
- M. ASTM C794 - Standard Test Method for Adhesion-In-Peel of Elastomeric Joint Sealants; 2015.
- N. ASTM E90 - Standard Test Method for Laboratory Measurement of Airborne Sound Transmission Loss of Building Partitions and Elements; 2009.
- O. ASTM E283 - Standard Test Method for Determining the Rate of Air Leakage Through Exterior Windows, Curtain Walls, and Doors Under Specified Pressure Differences Across the Specimen; 2004 (Reapproved 2012).
- P. ASTM E330/E330M - Standard Test Method for Structural Performance of Exterior Windows, Doors, Skylights and Curtain Walls by Uniform Static Air Pressure Difference; 2014.
- Q. ASTM E331 - Standard Test Method for Water Penetration of Exterior Windows, Skylights, Doors, and Curtain Walls by Uniform Static Air Pressure Difference; 2000 (Reapproved 2009).
- R. ASTM E413 - Classification for Rating Sound Insulation; 2010.
- S. ASTM E1105 - Standard Test Method for Field Determination of Water Penetration of Installed Exterior Windows, Skylights, Doors, and Curtain Walls, by Uniform or Cyclic Static Air Pressure Difference; 2015.
- T. California Code of Regulations, Title 24, Part 2, California Building Code (CBC), International Building Code, with California Amendments, current edition.
- U. California Code of Regulations, Title 24, Part 11 California Green Building Standards Code, "CAL-Green", current edition.
- V. National Fenestration Rating Council (NFRC). NFRC 100 Site Built Program.
- W. SSPC-Paint 20 - Zinc-Rich Primers (Type I, "Inorganic," and Type II, "Organic"); 2002 (Ed. 2004).

#### **1.04 ADMINISTRATIVE REQUIREMENTS**

- A. Coordinate with installation of other components that comprise the exterior enclosure.
- B. Preinstallation Meeting: Conduct a preinstallation meeting two weeks before starting work of this section, but not before completion of all required submittals; require attendance by all affected installers.
  - 1. Meet at Project site with Installer, installer of each component of associated work, installers of substrate construction to receive this work, installers of other work that must precede or follow curtainwall work, Architect/Owner, storefront system manufacturer's representative, and other representatives directly concerned with performance of the Work, including (where applicable) Owner's insurers, test agencies, and governing authorities. Objectives to include:

- a. Review preparation and installation procedures and coordinating and scheduling required with related work.
- b. Review methods and procedures related to curtainwall and glazing work.
- c. Review structural loading limitations of new curtainwall.
- d. Review curtainwall systems requirements (drawings, specifications, and other contract documents).
- e. Review required submittals, both completed and yet to be completed, including deferred approvals, if any.
- f. Review and finalize construction schedule related to curtainwall work and verify availability of materials, Installer's personnel, equipment, and facilities needed to make progress and avoid delays.
- g. Review required inspection, testing, certifying, and material usage accounting procedures.
- h. Review weather and forecasted weather conditions and procedures for coping with unfavorable conditions, including provision of temporary enclosure of partially completed or occupied spaces.
- i. Record discussion of conference, including decisions and agreements (or disagreements) reached, and furnish copy of record to each party attending. If substantial disagreements exist at conclusion of conference, determine how disagreements will be resolved and set date for reconvening conference.
- j. Review notification procedures for weather or non-working days.

#### **1.05 SUBMITTALS**

- A. See Section 01 3300 - Submittals, for submittal procedures.
- B. Provide submittals coordinated with submittals for related sections referenced in this Section for simultaneous review.
- C. Product Data: Provide component dimensions, describe components within assembly, anchorage and fasteners, internal drainage details, glazing, \_\_\_\_\_, and infill.
- D. VOC Submittals:
  1. Product Data - VOC Limits: For adhesives sealants, fillers and primers, documentation including printed statement of VOC contents.
- E. Shop Drawings: Indicate system dimensions, framed opening requirements and tolerances, affected related Work, expansion and contraction joint location and details, and field welding required.
  1. Shop drawings shall include project-specific integrations to surrounding cladding and waterproofing components including items specified in other sections.
  2. Provide installation instructions and isometric details indicating how system components will be installed and sealed watertight.
- F. Samples: Submit two samples \_\_\_\_\_by\_\_\_\_\_ inches (\_\_\_\_\_by\_\_\_\_\_ mm) in size illustrating finished aluminum surface, glazing, infill panels, and glazing materials.

#### **1.06 INFORMATIONAL SUBMITTALS**

- A. Delegated-Design Submittal: For glazed aluminum curtain walls indicated to comply with performance requirements and design criteria, substantiating system performance, structural capacity, anchorages and fasteners sizes and spacings per specified criteria, including analysis data signed and sealed by the qualified professional engineer responsible for their preparation.

1. Detail fabrication and assembly of aluminum-framed systems.
  2. Include design calculations.
  3. Assume role of "Responsible Party" for NFRC label testing and inspection "Certified Project Option". Make all arrangements necessary to perform required testing of site-built assembly and obtain NFRC label as described in NFRC 100.5.6.
- B. Certificate of Acceptance: Refer to California Energy Code Section 110.6.
1. Submit Certificate of Acceptance certifying that the fenestration product meets the required acceptance requirements, completed, signed and submitted to the enforcement agency, with copies to Owner and Architect.
  2. NFRC 100 Label Certificate: Submit proof of testing of site-built assembly and compliance with NFRC 100. Manufacturer certificates or factory tests are not acceptable for this requirement.
- C. Professional Engineer Qualifications: Demonstrate compliance with specified requirements.
- D. Qualification Data: For Installer and testing agency.
- E. Test Reports: Submit results of full-size mock-up testing. Reports of tests previously performed on the same design are acceptable.
- F. Field Quality Control Submittals: Report of field testing for water penetration and air leakage.
- G. Warranty: Submit manufacturer warranty and ensure forms have been completed in Owner's name and registered with manufacturer.
- H. Seismic Qualification Certificates: For aluminum-framed systems, accessories, and components, from manufacturer.
1. Basis for Certification: Indicate whether withstand certification is based on actual test of assembled components or on calculation.
- I. Welding certificates.
- J. Preconstruction Test Reports: For sealant.
- K. Product Test Reports: Based on evaluation of comprehensive tests performed by a qualified testing agency, for aluminum-framed systems, indicating compliance with performance requirements. For each system provide test reports with shop drawings
- L. Source quality-control reports.
1. Field quality-control reports.
- M. Warranties: Sample of special warranties.

#### **1.07 QUALITY ASSURANCE**

- A. Manufacturer Qualifications: Company specializing in manufacturing products specified in this section with not less than three years of documented experience.
- B. Professional Engineer Qualifications: A professional engineer who is legally qualified to practice in jurisdiction where Project is located and who is experienced in providing engineering services of the kind indicated. Engineering services are defined as those performed for installations of assemblies similar to those indicated for this Project in material, design, and extent.
- C. Engineering Responsibility: Prepare data for aluminum-framed systems, including Shop Drawings, based on testing and engineering analysis of manufacturer's standard units in systems similar to those indicated for this Project.

- D. NFRC Compliance: Completed site-built assembly shall conform to NFRC 100 requirements and be tested and labeled in accordance with that standard.
- E. Installer Qualifications: Manufacturer's authorized representative who is trained and approved for installation of units required for this Project, capable of assuming engineering responsibility. Installer shall have a minimum of 5 years experience with projects of similar type and scope.
- F. Testing Agency Qualifications: Qualified according to ASTM E 699 for testing indicated.
- G. Product Options: Information on Drawings and in Specifications establishes requirements for systems' aesthetic effects and performance characteristics. Aesthetic effects are indicated by dimensions, arrangements, alignment, and profiles of components and assemblies as they relate to sightlines, to one another, and to adjoining construction. Performance characteristics are indicated by criteria subject to verification by one or more methods including preconstruction testing, field testing, and in-service performance.
  - 1. Do not revise intended aesthetic effects, as judged solely by Architect, except with Architect's approval. If revisions are proposed, submit comprehensive explanatory data to Architect for review.
- H. Accessible Entrances: Comply with applicable provisions in the U.S. Architectural & Transportation Barriers Compliance Board's ADA-ABA Accessibility Guidelines and ICC/ANSI A117.1.

#### **1.08 DELIVERY, STORAGE, AND HANDLING**

#### **1.09 FIELD CONDITIONS**

- A. Field Measurements: Verify actual locations of structural supports for glazed aluminum curtain-wall systems by field measurements before fabrication and indicate measurements on Shop Drawings.
- B. Established Dimensions: Where field measurements cannot be made without delaying the Work, establish dimensions and proceed with fabricating glazed aluminum curtain-wall systems without field measurements. Coordinate construction to ensure that actual dimensions correspond to established dimensions
- C. Do not install sealants when ambient temperature is less than 40 degrees F (5 degrees C). Maintain this minimum temperature during and 48 hours after installation.

#### **1.10 SCHEDULING**

- A. Failure to provide timely and complete submission of all deferred approval submittals as specified requires provision of a temporary closure to fill-in wall openings until curtain wall assembly can be provided. Contractor shall provide temporary closure under provisions of Division 01 sections specifying temporary facilities without additional compensation.
  - 1. Construct temporary closure in sequence as required to permit other work to proceed without delay during processing of Deferred Approval submittals as specified elsewhere.
  - 2. Temporary closure shall consist of minimum 90 pound mineral cap roofing over a 30 pound base sheet over minimum one half inch plywood substrate, including all requisite support members needed to support the temporary closure indefinitely. The temporary closure shall be of equivalent load bearing capacity and watertightness as the surrounding permanent walls.
  - 3. Provide sheet metal edges and all other flashing for temporary closure as necessary to provide waterproofing identical to the curtain walls.

4. Remove and dispose of temporary closure as part of installation of curtain walls.

### **1.11 WARRANTY**

- A. See Section 01 7000 - Closeout Submittals, for additional warranty requirements.
- B. Special Assembly Warranty: Manufacturer agrees to repair or replace components of glazed aluminum curtain-wall systems that do not comply with requirements or that deteriorate as defined in this section within specified warranty period.
  1. Warranty shall have no dollar limit and shall include consequential damages and reimbursement for loss of use.
  2. Failures include, but are not limited to, the following:
    - a. Structural failures including, but not limited to, excessive deflection.
    - b. Noise or vibration caused by thermal movements.
    - c. Water penetration.
    - d. Failure of operating components.
  3. Warranty Period: Ten years from date of Substantial Completion.
- C. Special Finish Warranty: Manufacturer's standard form in which manufacturer agrees to repair finishes or replace components showing evidence of deterioration of factory-applied within specified warranty period.
  1. Deterioration includes, but is not limited to, the following:
    - a. Color fading more than 5 Hunter units when tested according to ASTM D 2244.
    - b. Chalking in excess of a No. 8 rating when tested according to ASTM D 4214.
    - c. Cracking, checking, peeling, or failure of paint to adhere to bare metal.
  2. Warranty Period: Twenty years from date of Substantial Completion.

## **PART 2 PRODUCTS**

### **2.01 PERFORMANCE REQUIREMENTS**

- A. VOC Limits for adhesives sealants, fillers and primers. Comply with limits specified in Section 01 6116.
- B. Delegated Design: Design glazed aluminum curtain walls, including comprehensive engineering analysis by Contractor's qualified professional engineer, using performance requirements and design criteria indicated.
- C. Assume role of "Responsible Party" for NFRC label testing and inspection "Certified Project Option". Make all arrangements necessary to perform required testing of site-built assembly and obtain NFRC label as described in NFRC 100.5.6. Contractor is responsible to obtain, including payment of all required fees, a label certificate for the site built fenestration system meeting requirements of California Energy Code 2013 Section 10-111(a)2 as described in California Energy Code Section 110.6.
- D. Thermally Broken: All components to be thermally broken with continuous resilient elastomeric extrusions.
- E. General Performance: Comply with performance requirements specified, as determined by testing of glazed aluminum curtain walls representing those indicated for this Project without failure due to defective manufacture, fabrication, installation, or other defects in construction.
  1. Glazed aluminum curtain walls shall withstand movements of supporting structure including, but not limited to, story drift, twist, column shortening, long-term creep, and deflection from uniformly distributed and concentrated live loads.
  2. Failure also includes the following:
    - a. Thermal stresses transferring to building structure.



- b. Framing members transferring stresses, including those caused by thermal and structural movements, to glazing.
  - c. Glass breakage.
  - d. Noise or vibration created by wind and thermal and structural movements.
  - e. Loosening or weakening of fasteners, attachments, and other components.
  - f. Sealant failure.
  - g. Failure of operating units.
- F. Weather Resistance:
- 1. Glazed aluminum curtain walls shall provide waterproofing and an air-vapor retarder that is continuous at all penetrations, transitions, and other conditions. Assemblies shall integrate with the building's waterproofing and air barrier / vapor-retarders to provide a weathertight transition.
  - 2. Air Movement: Assemblies shall not allow the movement of interior or exterior air to flow vertically within the assembly. Methods employed to prevent internal air movement shall not restrict water flow channels or prevent thermal movement of the frames.
  - 3. Water penetration into the assembly is acceptable only if all of the following conditions are satisfied; any other water penetration is considered water leakage and is unacceptable:
    - a. Water is immediately contained and drained to the exterior.
    - b. There is no wetting of a surface that could be damaged by moisture or that would be visible to building occupants.
    - c. There would be no staining or other damage to completed building or its furnishings.
    - d. This definition of water leakage governs over other definitions that may appear in referenced documents.
  - 4. Provide internal gutters and weep system to collect and drain water leakage and condensation to the exterior at the sill of each opening. Glazing assemblies shall have:
    - a. An isolated gutter cavity at each glass pane perimeter so that leakage is confined to and wept from the opening of leakage origin.
    - b. Continuous spliced gutters at mullion splices, with sealed end caps at termination conditions. Assemblies shall not direct water to contact edges of insulating glass units. Prevent water infiltration at weeps.
  - 5. Coordinate gutter and weep systems with exterior cladding assemblies specified in other sections, ensure drainage of accumulated water to exterior of building.

## 2.02 MANUFACTURERS

- A. Basis of Design: Product CW250; Oldcastle Building Envelope, [www.oldcastlebe.com](http://www.oldcastlebe.com).
- B. Other acceptable Glazed Aluminum Curtain Wall Manufacturers:
  - 1. EFCO, a Pella Company; 5500: [www.efcocorp.com](http://www.efcocorp.com).
  - 2. Kawneer North America: [www.kawneer.com](http://www.kawneer.com).
  - 3. Oldcastle Building Envelope: [www.oldcastlebe.com](http://www.oldcastlebe.com).
  - 4. Wausau Window and Wall Systems; SuperWall 6250-SW: [www.wausauwindow.com](http://www.wausauwindow.com).
  - 5. Substitutions: See Section 01 6000 - Product Requirements.

## 2.03 CURTAIN WALL

- A. Aluminum-Framed Curtain Wall: Factory fabricated, factory finished aluminum framing members with infill, and related flashings, anchorage and attachment devices.
  - 1. Inside glazed, with pressure plate and mullion cover.
  - 2. Finish: As indicated in FINISH article below .
    - a. Factory finish all surfaces that will be exposed in completed assemblies.

- b. Touch-up surfaces cut during fabrication so that no natural aluminum is visible in completed assemblies, including joint edges.
  - c. Coat concealed metal surfaces that will be in contact with cementitious materials or dissimilar metals with bituminous paint.
  3. Provide flush joints and corners, weathersealed, accurately fitted and secured; prepared to receive anchors; fasteners and attachments concealed from view; reinforced as required for imposed loads.
  4. Construction: Eliminate noises caused by wind and thermal movement, prevent vibration harmonics, and prevent "stack effect" in internal spaces.
  5. System Internal Drainage: Drain to the exterior by means of a weep drainage network any water entering joints, condensation occurring in glazing channel, and migrating moisture occurring within system.
  6. Air and Vapor Seal: Maintain continuous air barrier and vapor retarder throughout assembly, primarily in line with inside pane of glazing and inner sheet of infill panel and heel bead of glazing compound.
  7. Perimeter Clearance: Minimize space between framing members and adjacent construction while allowing expected movement.
- B. Structural Performance Requirements: Design and size components to withstand the following load requirements without damage or permanent set.
1. Design Wind Loads: Comply with the following:
    - a. As indicated on the Drawings.
    - b. Measure performance by testing in accordance with ASTM E330/E330M, using test loads equal to 1.5 times the design wind loads and 10 second duration of maximum pressure.
    - c. Member Deflection: For spans less than 13 feet 6 inches (4115 mm), limit member deflection to flexure limit of glass in any direction, and maximum of 1/175 of span or 3/4 inch (19 mm), whichever is less and with full recovery of glazing materials.
    - d. Member Deflection: For spans over 13 feet 6 inches (4115 mm) and less than 40 feet (12.2 m), limit member deflection to flexure limit of glass in any direction, and maximum of 1/240 of span plus 1/4 inch (1/240 of span plus 6.4 mm), with full recovery of glazing materials.
  2. Seismic Loads: As indicated on the Drawings.
  3. Interstory Differential Lateral Movement: Meeting pass/fail criteria of AAMA 501.4 for Use Group I, Standard Occupancy, when tested at design displacement of 0.010 times greater adjacent story height, maximum, and 1.5 times design displacement, through three complete cycles.
  4. Movement: Accommodate the following movement without damage to components or deterioration of seals:
    - a. Expansion and contraction caused by 180 degrees F (82 degrees C) surface temperature.
    - b. Expansion and contraction caused by cycling temperature range of 170 degrees F (77 degrees C) over a 12 hour period.
    - c. Movement of curtain wall relative to perimeter framing.
    - d. Deflection of structural support framing, under permanent and dynamic loads.
    - e. Interstory drift as described on Structural Drawings.
    - f. Mid-span slab edge deflection as described on Structural Drawings.
- C. Water Penetration Resistance on Manufactured Assembly: No uncontrolled water on indoor face when tested as follows:
1. Test Pressure Differential: 10 psf (480 Pa).
  2. Test Method: ASTM E331.

- D. Air Leakage Laboratory Test: Maximum of 0.06 cu ft/min sq ft (0.3 L/sec sq m) of wall area, when tested in accordance with ASTM E283 at 6.27 psf (300 Pa) pressure differential across assembly.
- E. Thermal Performance Requirements:
  - 1. Condensation Resistance Factor of Framing: 50, minimum, measured in accordance with NFRC 100.
  - 2. Overall U-value Including Glazing: \_\_\_\_\_ Btu/(hr sq ft deg F), maximum.
- F. Acoustical Performance Requirements:
  - 1. Sound Attenuation: STC of 30, minimum, from exterior to interior.
  - 2. Test Method: ASTM E90, with calculation in accordance with ASTM E413.

#### 2.04 COMPONENTS

- A. Aluminum Framing Members: Tubular aluminum sections, thermally broken with interior section insulated from exterior, drainage holes and internal weep drainage system.
  - 1. Cross-Section: As indicated on drawings.
  - 2. Structurally Reinforced Members: Extruded aluminum with internal reinforcement of structural steel member.
- B. Glazing: As specified in Section 08 8000.
- C. Infill Panels: Insulated, aluminum sheet face and back, with edges formed to fit glazing channel and sealed.
  - 1. Core: Glass Fiber or mineral board insulation.
  - 2. Exterior Finish: Match aluminum framing.
  - 3. Interior Finish: Match aluminum framing.

#### 2.05 MATERIALS

- A. Extruded Aluminum: ASTM B221 (ASTM B221M).
- B. Sheet Aluminum: ASTM B209 (ASTM B209M).
- C. Structural Steel Sections: ASTM A36/A36M; galvanized in accordance with requirements of ASTM A123/A123M.
- D. Structural Supporting Anchors Attached to Structural Steel: Design for bolted attachment.
- E. Fasteners: Stainless steel; type as required or recommended by curtain wall manufacturer.
- F. Exposed Flashings: Aluminum sheet, 20 gage, 0.032 inch (0.81 mm) minimum thickness; finish to match framing members.
- G. Concealed Flashings: Stainless steel, 26 gage, 0.0187 inch (0.48 mm) minimum thickness.
- H. Firestopping: As specified in Section 07 8400.
- I. Weatherseal Sealant: Silicone, with adhesion in compliance with ASTM C794; compatible with glazing accessories.
- J. Glazing Gaskets: Type to suit application to achieve weather, moisture, and air infiltration requirements.
- K. Glazing Accessories: As specified in Section 08 8000.
- L. Touch-Up Primer for Galvanized Steel Surfaces: SSPC-Paint 20, zinc rich.

## 2.06 FINISHES

- A. Superior Performing Organic Coatings System: Polyvinylidene fluoride (PVDF) multi-coat superior performing organic coatings system complying with AAMA 2605, including at least 70 percent PVDF resin, and at least 80 percent of aluminum extrusion and panels surfaces having minimum total dry film thickness (DFT) of 1.2 mils, 0.0012 inch (0.030 mm).
  1. Manufacturers:
    - a. PPG Metal Coatings; Duranar: [www.ppgmetalcoatings.com/#sle](http://www.ppgmetalcoatings.com/#sle).
    - b. Sherwin-Williams Company; SHER-NAR 5000: [oem.sherwin-williams.com/#sle](http://oem.sherwin-williams.com/#sle).
    - c. Valspar; Fluropon: [www.valsparcoilextrusion.com/#sle](http://www.valsparcoilextrusion.com/#sle).
    - d. Substitutions: See Section 01 6000 - Product Requirements.
- B. Color(s) as selected by Architect from:
  1. Manufacturer's full range of standard colors.
- C. Touch-Up Materials: As recommended by coating manufacturer for field application.

## PART 3 EXECUTION

### 3.01 EXAMINATION

- A. Verify dimensions, tolerances, and method of attachment with other related work.
- B. Verify that curtain wall openings and adjoining air and vapor seal materials are ready to receive work of this section.
- C. Verify that anchorage devices have been properly installed and located.

### 3.02 INSTALLATION

- A. Install curtain wall system in accordance with manufacturer's instructions.
- B. Attach to structure to permit sufficient adjustment to accommodate construction tolerances and other irregularities.
- C. Provide alignment attachments and shims to permanently fasten system to building structure.
- D. Align assembly plumb and level, free of warp or twist. Maintain assembly dimensional tolerances, aligning with adjacent work.
- E. Provide thermal isolation where components penetrate or disrupt building insulation.
- F. Install sill flashings. Turn up ends and edges; seal to adjacent work to form water tight dam.
- G. Pack fibrous insulation in shim spaces at perimeter of assembly to maintain continuity of thermal barrier.
- H. Touch-up minor damage to factory applied finish; replace components that cannot be satisfactorily repaired.

### 3.03 TOLERANCES

- A. Maximum Variation from Plumb: 0.06 inches every 3 ft (1.5 mm/m) non-cumulative or 0.5 inches per 100 ft (12 mm/30 m), whichever is less.
- B. Maximum Misalignment of Two Adjoining Members Abutting in Plane: 1/32 inch (0.8 mm).
- C. Sealant Space Between Curtain Wall Mullions and Adjacent Construction: Maximum of 3/4 inch (19 mm) and minimum of 1/4 inch (6 mm).

### 3.04 FIELD QUALITY CONTROL

- A. Provide services of curtain wall manufacturer's field representative to observe for proper installation of system and submit report.
- B. See Section 01 4000 - Quality Requirements, for independent field testing and inspection requirements, and requirements for monitoring quality of specified product installations.
- C. Water-Spray Test: Provide water spray quality test of installed curtain wall components in accordance with AAMA 501.2 during construction process and before installation of interior finishes.
  - 1. Perform a minimum of two tests in each designated area as indicated on drawings.
  - 2. Conduct tests in each area prior to 10 percent and 50 percent completion of this work.
- D. Provide field testing of installed curtain wall system by independent laboratory in accordance with AAMA 503 during construction process and before installation of interior finishes.
  - 1. Perform a minimum of two tests in each designated area as indicated on drawings.
  - 2. Conduct tests in each area prior to 10 percent and 50 percent completion of this work.
  - 3. Field test for water penetration in accordance with ASTM E1105 with uniform static air pressure difference (Procedure A) not less than 4.18 psf (200 Pa).
    - a. Maximum allowable rate of water penetration in 15-minute test is 0.5 ounce (14 gram) that is not contained in an area with provisions to drain to exterior, or collected on surface of interior horizontal framing member.
- E. Repair or replace curtain wall components that have failed designated field testing, and retest to verify performance complies with specified requirements.
- F. Fenestration Acceptance Requirements: Refer to California Energy Code Section 110.6.
  - 1. Before an occupancy permit is granted, site-built fenestration products in other than low-rise residential buildings shall be certified as meeting the Acceptance Requirements for Code Compliance, as specified in the Reference Nonresidential Appendix NA7 to ensure that site-built fenestration meet Standards requirements, including a matching label certificate for product(s) installed and be readily accessible at the project location.
  - 2. Contractor is responsible to prepare and obtain a Certificate of Acceptance certifying that the fenestration product meets the acceptance requirements, completed, signed and submitted to the enforcement agency, including payment of all fees, with copies to Owner and Architect.
  - 3. Arrange testing and inspection of site-built assembly as required to obtain a project-specific NFRC 100 certificate of compliance.

### 3.05 ADJUSTING

- A. Adjust operating sash for smooth operation.

### 3.06 CLEANING

- A. Remove protective material from pre-finished aluminum surfaces.
- B. Upon completion of installation, thoroughly clean aluminum surfaces in accordance with AAMA 609 & 610.

### 3.07 PROTECTION

- A. Protect installed products from damage until Date of Substantial Completion.

**END OF SECTION**



**SECTION 08 5113**  
**ALUMINUM WINDOWS**

**PART 1 GENERAL**

**1.01 SECTION INCLUDES**

- A. Extruded aluminum windows with fixed sash, operating sash, and infill panels.
- B. Site glazing.
- C. Operating hardware.
- D. Insect screens.

**1.02 RELATED REQUIREMENTS**

- A. Pertinent Sections specifying Volatile Organic Compound (VOC) Content Restrictions.
- B. Section 06 1000 - Rough Carpentry: Rough openings.
- C. Section 07 2500 - WEATHER BARRIERS: Sealing frame to weather barrier installed on adjacent construction.
- D. Section 07 9200 - Joint Sealants: Sealing joints between window frames and adjacent construction.
- E. Section 08 8000 - Glazing.

**1.03 REFERENCE STANDARDS**

- A. AAMA American Architectural Manufacturers Association, Certified Products Directory.
- B. AAMA/WDMA/CSA 101/I.S.2/A440 - North American Fenestration Standard/Specification for windows, doors, and skylights; 2011.
- C. AAMA CW-10 - Care and Handling of Architectural Aluminum From Shop to Site; 2015.
- D. AAMA 502 - Voluntary Specification for Field Testing of Newly Installed Fenestration Products; 2012.
- E. AAMA 609 & 610 - Cleaning and Maintenance Guide for Architecturally Finished Aluminum (Combined Document); 2015.
- F. AAMA 611 - Voluntary Specification for Anodized Architectural Aluminum; 2012.
- G. AAMA 2400-02 - Standard Practice for Installation of Windows with a Mounting Flange in Stud Frame Construction.
- H. AAMA 2605 - Voluntary Specification, Performance Requirements and Test Procedures for Superior Performing Organic Coatings on Aluminum Extrusions and Panels; 2013.
- I. ASCE 7 - Minimum Design Loads for Buildings and Other Structures; 2010, with 2013 Supplements and Errata.
- J. ASHRAE Std 90.1 I-P - Energy Standard for Buildings Except Low-Rise Residential Buildings; 2013, Including All Amendments and Errata.
- K. ASTM A123/A123M - Standard Specification for Zinc (Hot-Dip Galvanized) Coatings on Iron and Steel Products; 2015.

- L. ASTM B209 - Standard Specification for Aluminum and Aluminum-Alloy Sheet and Plate; 2014.
- M. ASTM B221 - Standard Specification for Aluminum and Aluminum-Alloy Extruded Bars, Rods, Wire, Profiles, and Tubes; 2014.
- N. ASTM B221M - Standard Specification for Aluminum and Aluminum-Alloy Extruded Bars, Rods, Wire, Profiles, and Tubes [Metric]; 2013.
- O. ASTM E283 - Standard Test Method for Determining the Rate of Air Leakage Through Exterior Windows, Curtain Walls, and Doors Under Specified Pressure Differences Across the Specimen; 2004 (Reapproved 2012).
- P. ASTM E330 - Standard Test Method for Structural Performance of Exterior Windows, Doors, Skylights and Curtain Walls by Uniform Static Air Pressure Difference; 2002 (Reapproved 2010).
- Q. ASTM E331 - Standard Test Method for Water Penetration of Exterior Windows, Skylights, Doors, and Curtain Walls by Uniform Static Air Pressure Difference; 2000 (Reapproved 2009).
- R. ASTM E783 - Standard Test Method for Field Measurement of Air Leakage Through Installed Exterior Windows and Doors; 2002 (Reapproved 2010).
- S. ASTM E1105 - Standard Test Method for Field Determination of Water Penetration of Installed Exterior Windows, Skylights, Doors, and Curtain Walls, by Uniform or Cyclic Static Air Pressure Difference; 2015.
- T. ASTM E2112 - Standard Practice for Installation of Exterior Windows, Doors and Skylights; 2007.
- U. ASTM F588 - Standard Test Methods for Measuring the Forced Entry Resistance of Window Assemblies, Excluding Glazing Impact; 2014.
- V. California Code of Regulations, Title 24, Part 11 California Green Building Standards Code, "CAL-Green".
- W. National Fenestration Ratings Council, Certified Products Directory. <http://cpd.nfrc.org/>.
- X. SSPC-Paint 20 - Zinc-Rich Primers (Type I, "Inorganic," and Type II, "Organic"); 2002 (Ed. 2004).

#### **1.04 ADMINISTRATIVE REQUIREMENTS**

- A. Coordinate with installation of other components that comprise the exterior enclosure.
- B. Preinstallation Meeting: Conduct a preinstallation meeting two weeks before starting work of this section, but not before approval of all required submittals; require attendance by all affected installers.
  - 1. Meet at Project site with Installer, installer of each component of associated work, installers of substrate construction to receive this work, installers of other work that must precede or follow window work (including mechanical work if any), Architect/Owner, window manufacturer's representative, and other representatives directly concerned with performance of the Work, including (where applicable) Owner's insurers, test agencies, and governing authorities. Objectives to include:
    - a. Review preparation and installation procedures and coordinating and scheduling required with related work.
    - b. Review methods and procedures related to window and glazing work.



- c. Review structural loading limitations of new windows.
- d. Review window requirements (drawings, specifications, and other contract documents).
- e. Review required submittals, including deferred approvals, if any.
- f. Review and finalize construction schedule related to windows and verify availability of materials, Installer's personnel, equipment, and facilities needed to make progress and avoid delays.
- g. Review required inspection, testing, certifying, and material usage accounting procedures.
- h. Review weather and forecasted weather conditions and procedures for coping with unfavorable conditions, including provision of temporary enclosure of partially completed or occupied spaces.
- i. Record discussion of conference, including decisions and agreements (or disagreements) reached, and furnish copy of record to each party attending. If substantial disagreements exist at conclusion of conference, determine how disagreements will be resolved and set date for reconvening conference.
- j. Review notification procedures for weather or non-working days.

#### **1.05 SUBMITTALS**

- A. See Section 01 3300 - Submittals, for submittal procedures.
- B. Product Data: Provide component dimensions, information on glass and glazing, internal drainage details, descriptions of hardware and accessories, and information on exterior finishes. Demonstrate compliance with specified attributes.
- C. CAL-GREEN Submittals: Product Data - VOC Limits: For adhesives sealants, fillers, primers and coatings, documentation including printed statement of VOC contents, comply with limits specified in related section.
- D. Shop Drawings: Indicate opening dimensions, elevations of different types, framed opening tolerances, method for achieving air and vapor barrier seal to adjacent construction, anchorage locations, and installation requirements.
- E. Samples: Submit two samples, 12 by 12 inch (300 by 300 mm) in size illustrating typical corner construction, accessories, and finishes.
- F. Grade Substantiation: Prior to submitting shop drawings or starting fabrication, submit one of the following showing compliance with specified grade:
  - 1. Evidence of AAMA Certification.
  - 2. Evidence of WDMA Certification.
  - 3. Evidence of CSA Certification.
  - 4. Test report(s) by independent testing agency itemizing compliance and acceptable to authorities having jurisdiction.
- G. Test Reports: Prior to submitting shop drawings or starting fabrication, submit test report(s) by independent testing agency showing compliance with performance requirements in excess of those prescribed by specified grade.
- H. Certificates: Certify that windows meet or exceed specified requirements.
- I. Manufacturer's Installation Instructions: Include complete preparation, installation, and cleaning requirements.
- J. Field Quality Control Submittals: Report of field testing for water penetration and air leakage.

- K. Warranty: Submit manufacturer warranty and ensure that forms have been completed in Owner's name and registered with manufacturer.

#### **1.06 QUALITY ASSURANCE**

- A. Manufacturer Qualifications: Company specializing in manufacturing products specified in this section with minimum three years of documented experience.

#### **1.07 DELIVERY, STORAGE, AND HANDLING**

- A. Comply with requirements of AAMA CW-10.
- B. Protect finished surfaces with wrapping paper or strippable coating during installation. Do not use adhesive papers or sprayed coatings that bond to substrate when exposed to sunlight or weather.

#### **1.08 FIELD CONDITIONS**

- A. Do not install sealants when ambient temperature is less than 40 degrees F (5 degrees C).
- B. Maintain this minimum temperature during and 24 hours after installation of sealants.

#### **1.09 WARRANTY**

- A. See Section 01 7000 - Closeout Submittals, for additional warranty requirements.
- B. Correct defective Work within a five year period after Date of Substantial Completion.
- C. Provide ten year manufacturer warranty against failure of glass seal on insulating glass units, including interpane dusting or misting. Include provision for replacement of failed units.
- D. Provide ten year manufacturer warranty against excessive degradation of exterior finish. Include provision for replacement of units with excessive fading, chalking, or flaking.

### **PART 2 PRODUCTS**

#### **2.01 MANUFACTURERS**

- A. Aluminum Windows:
  - 1. All-Weather, Vacaville, CA: [www.allweathersweb.com](http://www.allweathersweb.com).
  - 2. Columbia Commercial Building Products; Rockwall TX: [www.ccbpwin.com](http://www.ccbpwin.com).
- B. Substitutions: See Section 01 6000 - Product Requirements.

#### **2.02 WINDOWS**

- A. Aluminum Windows: Extruded aluminum frame and sash, factory fabricated, factory finished, with operating hardware, related flashings, and anchorage and attachment devices.
  - 1. Frame Depth: As indicated on Drawings.
  - 2. Operable Units: Double weatherstripped.
  - 3. Fabrication: Joints and corners flush, hairline, and weatherproof, accurately fitted and secured; prepared to receive anchors; fasteners and attachments concealed from view; reinforced as required for operating hardware and imposed loads.
  - 4. Perimeter Clearance: Minimize space between framing members and adjacent construction while allowing expected movement.
  - 5. Movement: Accommodate movement between window and perimeter framing and deflection of lintel, without damage to components or deterioration of seals.

6. System Internal Drainage: Drain to the exterior by means of a weep drainage network any water entering joints, condensation occurring in glazing channel, and migrating moisture occurring within system.
  7. Air and Vapor Seal: Maintain continuous air barrier and vapor retarder throughout assembly.
  8. Thermal Movement: Design to accommodate thermal movement caused by 180 degrees F (82.2 degrees C) surface temperature without buckling stress on glass, joint seal failure, damaging loads on structural elements, damaging loads on fasteners, reduction in performance or other detrimental effects.
- B. Types: As indicated.
1. Construction: Thermally broken.
    - a. Frames at walls: Include integral fin all around with sealed corner joints.
    - b. Glazing beads: Extruded type.

### 2.03 PERFORMANCE REQUIREMENTS

- A. Grade: AAMA/WDMA/CSA 101/I.S.2/A440 requirements for specific window type:
  1. Performance Class (PC): CW.
  2. Performance Grade (PG): 30, with minimum design pressure (DP) of 30.08 psf (1440 Pa).
- B. Water Leakage: No uncontrolled leakage on interior face when tested in accordance with ASTM E331 at differential pressure of 12.11 psf (580 Pa).
- C. Air Leakage: Maximum of 0.1 cu ft/min sq ft (0.5 L/sec sq m) per unit area of outside frame dimension, with 6.27 psf (300 Pa) differential pressure when tested in accordance with ASTM E283.
- D. Solar Heat Gain Coefficient: 0.55.
- E. Visible Transmittance: 0.53.
- F. Fenestration Assembly Thermal Transmittance (U-value): Comply with ASHRAE Std 90.1 I-P for building envelope requirements for applicable climate zone.
- G. Forced Entry Resistance: Tested to comply with ASTM F588 requirements for performance level of Grade 10 for specific window style required.

### 2.04 COMPONENTS

- A. Frames: Thermally broken with interior portion of frame insulated from exterior portion; flush glass stops of snap-on or screw-down type.
- B. Glazing: As specified in Section 08 8000.
- C. Sills: Extruded aluminum; sloped for positive wash; fit under sash leg to 1/2 inch beyond wall face; one piece full width of opening jamb angles to terminate sill end.
- D. Insect Screens: Extruded aluminum frame with mitered and reinforced corners; screen mesh taut and secure to frame; secured to window with adjustable hardware allowing screen removal without use of tools.
  1. Hardware: Spring loaded steel pins; four per screen unit.
  2. Screen Mesh: Vinyl-coated fiberglass, window manufacturer's standard mesh.
  3. Frame Finish: Same as frame and sash.
- E. Operable Sash Weatherstripping: Nylon pile; permanently resilient, profiled to achieve effective weather seal.

- F. Fasteners: Stainless steel, No. 6 or larger for attachments of nailfins to framing.
- G. Glazing Materials: As specified in Section 08 8000.
- H. Sealant for Setting Sills and Sill Flashing: Non-curing butyl type.
- I. Sealant and Backing Materials: As specified in Section 07 9200.

## **2.05 MATERIALS**

- A. Extruded Aluminum: ASTM B221 (ASTM B221M), 6063 alloy, T6 temper.
- B. Flashing Material: Self-adhered, flexible type specified in Section 07 2500, compatible with air and water barriers specified in related section.
- C. Concealed Steel Items: Profiled to suit mullion sections; galvanized in accordance with ASTM A123/A123M.

## **2.06 HARDWARE**

- A. Locks, operators, sash arms, rollers: Manufacturer's standard for operating types indicated.
- B. Pulls: Manufacturer's standard type.
- C. Limit Stops: Resilient rubber.

## **2.07 FABRICATION**

- A. Fabricate components with smallest possible clearances and shim spacing around perimeter of assembly that will enable window installation and dynamic movement of perimeter seal.
- B. Accurately fit and secure joints and corners. Make joints flush, hairline, and weatherproof.
- C. Prepare components to receive anchor devices.
- D. Arrange fasteners and attachments to ensure concealment from view.
- E. Prepare components with internal reinforcement for operating hardware.
- F. Provide steel internal reinforcement in mullions as required to meet loading requirements.
- G. Provide internal drainage of glazing spaces to exterior through weep holes.
- H. Assemble insect screen frames with mitered and reinforced corners. Secure wire mesh tautly in frame. Fit frame with four, spring loaded steel pin retainers.

## **2.08 FINISHES**

- A. Superior Performing Organic Coatings System: Polyvinylidene fluoride (PVDF) multi-coat superior performing organic coatings system complying with AAMA 2605, including at least 70 percent PVDF resin, and at least 80 percent of aluminum extrusion and panels surfaces having minimum total dry film thickness (DFT) of 1.2 mils, 0.0012 inch (0.030 mm).
  - 1. Manufacturers:
    - a. PPG Metal Coatings; Duranar: [www.ppgmetalcoatings.com/#sle](http://www.ppgmetalcoatings.com/#sle).
    - b. Sherwin-Williams Company; SHER-NAR 5000: [oem.sherwin-williams.com/#sle](http://oem.sherwin-williams.com/#sle).
    - c. Valspar; Fluropon: [www.valsparcoilextrusion.com/#sle](http://www.valsparcoilextrusion.com/#sle).
    - d. Substitutions: See Section 01 6000 - Product Requirements.
- B. Color(s) as selected by Architect from:
  - 1. Manufacturer's full range of standard colors.

- C. Operator and Exposed Hardware: Enameled to color as selected from manufacturer's standard line.
- D. Apply one coat of bituminous coating to concealed aluminum and steel surfaces in contact with dissimilar materials.
- E. Touch-Up Primer for Galvanized Steel Surfaces: SSPC-Paint 20, zinc rich.

### **PART 3 EXECUTION**

#### **3.01 EXAMINATION**

- A. Verify that wall openings and adjoining air and vapor seal materials are ready to receive aluminum windows.

#### **3.02 INSTALLATION**

- A. Install windows in accordance with manufacturer's instructions and the referenced standards.
  - 1. Screw framing members in place using backing, anchor plugs, or straps as required to make secure when subjected to imposed loads. Where moldings are jointed, accurately cut and fit to provide a tightly closed joint.
  - 2. Attach window frame and shims to perimeter opening to accommodate construction tolerances and other irregularities.
  - 3. Install so that weather-stripping makes continuous positive contact when window is in closed position.
- B. Install window assembly in accordance with AAMA/WDMA/CSA 101/1.S.2/A440.
- C. Install windows in accordance with ASTM E2112.
- D. Attach window frame and shims to perimeter opening to accommodate construction tolerances and other irregularities.
- E. Align window plumb and level, free of warp or twist. Maintain dimensional tolerances and alignment with adjacent work.
- F. Install sill and sill end angles.
- G. Set sill members and sill flashing in continuous bead of sealant.
- H. Provide thermal isolation where components penetrate or disrupt building insulation. Pack fibrous insulation in shim spaces at perimeter of assembly to maintain continuity of thermal barrier.
- I. Install opening flashings coordinated with air and water resistive barriers specified in related sections, in accordance with AAMA 2400-02 - Standard Practice for Installation of Windows with a Mounting Flange in Stud Frame Construction. Ensure water entering wall assemblies is directed to the exterior.
- J. Install operating hardware not pre-installed by manufacturer.
- K. Align and adjust vents for optimum weathering contact to the frame and ease of operation.
- L. Install glass and infill panels in accordance with requirements specified in Section 08 8000.
- M. Maintain attachment and seal of perimeter air barrier and vapor retarder materials.

### **3.03 TOLERANCES**

- A. Maximum Variation from Level or Plumb: 1/16 inches every 3 ft (1.5 mm/m) non-cumulative or 1/8 inches per 10 ft (3 mm/3 m), whichever is less.

### **3.04 FIELD QUALITY CONTROL**

- A. Provide services of aluminum window manufacturer's field representative to observe for proper installation of system and submit report.
- B. See Section 01 4000 - Quality Requirements, for independent field testing and inspection requirements, and requirements for monitoring quality of specified product installations.
- C. Provide field testing of installed aluminum windows by independent laboratory in accordance with AAMA 502 and AAMA/WDMA/CSA 101/IS.2/A440 during construction process and before installation of interior finishes.
  - 1. Perform tests on three individual windows in designated locations as directed by Architect.
  - 2. Conduct tests on individual windows prior to 5 percent, 50 percent, and 90 percent completion of this work.
  - 3. Field test for water penetration in accordance with ASTM E1105 using Procedure B - cyclic static air pressure difference; test pressure shall not be less than 1.9 psf (91 Pa).
  - 4. Field test for air leakage in accordance with ASTM E783 with uniform static air pressure difference of 1.57 psf (75 Pa).
- D. Repair or replace fenestration components that have failed designated field testing, and retest to verify performance complies with specified requirements.

### **3.05 ADJUSTING**

- A. Adjust hardware for smooth operation and secure weathertight closure.

### **3.06 CLEANING**

- A. Remove protective material from factory finished aluminum surfaces.
- B. Wash surfaces by method recommended and acceptable to window manufacturer; rinse and wipe surfaces clean.
- C. Upon completion of installation, thoroughly clean aluminum surfaces in accordance with AAMA 609 & 610.
- D. Touch-up factory finishes; no raw metal visible.
- E. After installation check and adjust primary and secondary locks to assure proper function.
- F. Protect finished work including finishes from subsequent construction.

**END OF SECTION**

**SECTION 08 5600**  
**SPECIAL WINDOWS**

**PART 1 GENERAL**

**1.01 SECTION INCLUDES**

- A. Sliding Service Windows.
- B. Transaction Windows.

**1.02 RELATED SECTIONS**

- A. Section 06 1000- Rough Carpentry: Opening Framing.
- B. Section 06 4100 - Architectural Wood Casework.
- C. Section 08 5113 - Aluminum Windows: Aluminum Windows.
- D. Section 11 4000- Food Service Equipment: Stainless steel countertops.

**1.03 REFERENCES**

- A. UL 752 - Standard for Bullet-Resisting Equipment, Underwriters Laboratories Inc., March 2000.

**1.04 SUBMITTALS**

- A. See Section 01 3300 - Submittals for submittal procedures.
- B. Product Data: Provide manufacturer's product data and installation instructions.
- C. Shop Drawings: Indicate opening dimensions, elevations of types, anchorage size and location, installation requirements.
- D. Certificates: Certify that products of this section meet or exceed specified requirements.
- E. Warranty: Submit manufacturer warranty and ensure that forms have been completed in Owner's name and registered with manufacturer.

**1.05 DELIVERY, STORAGE, AND PROTECTION**

- A. Deliver products and materials to project site in original containers and packaging.
- B. Comply with pertinent provisions of Section 01 6000.

**1.06 WARRANTY**

- A. See Section 01 7000 - Contract Closeout, for additional warranty requirements.
- B. Correct defective Work within a two year period after Date of Substantial Completion.

**PART 2 PRODUCTS**

**2.01 PERFORMANCE REQUIREMENTS**

- A. Conform to UL Standard 752 for Bullet-Resistant Glazing Materials Level specified.

**2.02 MANUFACTURED UNITS**

- A. Sliding Service Window. Vertical sliding window with sliding screen.
  - 1. Nylon runners over coiled compression springs. Window and screen hold in placed position.

2. Frames and glass channels: 6063-T5 aluminum.
3. Lock: Interior slide type, manufacturer's standard.
4. Glass: 1/4 inch clear tempered, factory glazed.
5. Frame surround: manufacturer's standard.
6. Screen: gray fiberglass, insect resistant.
7. Counter seal: wool pile.
8. Finish: as selected from manufacturer's standards.
9. Manufacturers:
  - a. CRL: Self Closing Service window
  - b. Substitutions: See Section 01 6000 - Product Requirements.

### **2.03 ACCESSORIES**

- A. Accessory Materials: Other materials not specifically indicated but required to achieve the results specified; commercial quality.
- B. Sealant: Compatible material of types specified in Section 07 9200.

## **PART 3 EXECUTION**

### **3.01 EXAMINATION**

- A. Verify that field conditions are acceptable and are ready to receive work. Correct conditions detrimental to the proper and timely performance of this work before proceeding with installation. Commencement of work indicates acceptance of substrates.
- B. Verify all opening sizes, dimensions and tolerances in field.

### **3.02 INSTALLATION**

- A. Install in accordance with manufacturer's instructions, level plumb and square.
- B. Fastening to In-Place Construction: Provide anchorage devices and fasteners where necessary for securing components to in-place construction; including threaded fasteners for concrete or masonry inserts, wood screws, and other connectors as required.
- C. Coordinate with installation of countertop.
- D. Seal perimeter for watertight, weatherproof installation.

### **3.03 ADJUSTING**

- A. Repair damaged and defective work and eliminate functional and visual defects. Where repair is not possible replace work. Adjust joints for uniform appearance. No unfinished surfaces or irregularities in completed work.
- B. Adjust operable components for smooth operation.

### **3.04 CLEANING and PROTECTION**

- A. Clean and protect installed units from subsequent construction operations.

**END OF SECTION**



**SECTION 08 6223**  
**TUBULAR SKYLIGHTS**

**PART 1 GENERAL**

**1.01 SECTION INCLUDES**

- A. Tubular skylights, consisting of skylight dome, reflective tube, and diffuser assembly.

**1.02 RELATED SECTIONS**

- A. Pertinent Sections specifying Volatile Organic Compound (VOC) Content Restrictions.
- B. Section 06 1000 - Rough Carpentry: Wood framing for rough opening.
- C. Section 07 5550 - Modified Bitumen
- D. Division 26: Pertinent sections specifying provision of power to motorized components.

**1.03 REFERENCE STANDARDS**

- A. AAMA/WDMA/CSA 101/IS.2/A440 - North American Fenestration Standard/Specification for windows, doors, and skylights; 2011.
- B. ASTM A653/A653M - Standard Specification for Steel Sheet, Zinc-Coated (Galvanized) or Zinc-Iron Alloy-Coated (Galvannealed) by the Hot-Dip Process; 2015.
- C. ASTM B209 - Standard Specification for Aluminum and Aluminum-Alloy Sheet and Plate; 2014.
- D. ASTM B209M - Standard Specification for Aluminum and Aluminum-Alloy Sheet and Plate [Metric]; 2014.
- E. ASTM D1003 is the American Society for Testing and Materials document entitled "Standard Test Method for Haze and Luminous Transmittance of Transparent Plastics," 2000 (ANSI/ASTM D1003-00).
- F. ASTM D2843 - Standard Test Method for Density of Smoke from the Burning or Decomposition of Plastics; 2010.
- G. ASTM E84 - Standard Test Method for Surface Burning Characteristics of Building Materials; 2015a.
- H. ASTM E283 - Standard Test Method for Determining the Rate of Air Leakage Through Exterior Windows, Curtain Walls, and Doors Under Specified Pressure Differences Across the Specimen; 2004 (Reapproved 2012).
- I. ASTM E331 - Standard Test Method for Water Penetration of Exterior Windows, Skylights, Doors, and Curtain Walls by Uniform Static Air Pressure Difference; 2000 (Reapproved 2009).
- J. California Code of Regulations, Title 24, Part 2, California Building Code (CBC), International Building Code.
- K. California Code of Regulations, Title 24, Part 11 California Green Building Standards Code, "CAL-Green".

**1.04 SUBMITTALS**

- A. See Section 01 3300 - Submittals for submittal procedures.
- B. Product Data: Provide structural, thermal, and daylighting performance values.

- C. CAL-GREEN Submittals: Product Data – VOC Limits: For adhesives sealants, fillers, primers and coatings, documentation including printed statement of VOC contents, comply with limits specified in related section.
- D. Shop Drawings: Indicate configurations, dimensions, locations, fastening methods, and installation details.
- E. Samples: Specified interior facing of the tube.
- F. Manufacturer's Installation Instructions: Indicate special procedures.
- G. Grade Substantiation: Prior to submitting shop drawings or starting fabrication, submit one of the following showing compliance with specified grade:
  - 1. Evidence of AAMA Certification.
  - 2. Evidence of WDMA Certification.
  - 3. Evidence of CSA Certification.
  - 4. Test report(s) by independent testing agency itemizing compliance and acceptable to authorities having jurisdiction.
- H. Test Reports: Prior to submitting shop drawings or starting fabrication, submit test report(s) by independent testing agency showing compliance with performance requirements in excess of those prescribed by specified grade.

#### **1.05 QUALITY ASSURANCE**

- A. Manufacturer Qualifications: Company specializing in manufacturing products specified in this section with not less than ten years documented experience.
- B. Installer Qualifications: Company specializing in performing work of the type specified and with at least five years documented experience.
  - 1. Installer to be factory trained and/or certified by the manufacturer prior to commencement of installation.

#### **1.06 DELIVERY, STORAGE, AND HANDLING**

- A. Store products in manufacturer's unopened packaging until ready for installation.
- B. Store and dispose of solvent-based materials, and materials used with solvent-based materials, in accordance with requirements of local authorities having jurisdiction.

#### **1.07 PROJECT CONDITIONS**

- A. Coordinate the work with the installation of roofing system.

#### **1.08 WARRANTY**

- A. See Section 01 7000 - Contract Closeout, for additional warranty submittal requirements.
- B. Provide ten year manufacturer warranty for discoloration and leakage including leakage due to defective tubular skylight materials or workmanship.

### **PART 2 PRODUCTS**

#### **2.01 MANUFACTURERS**

- A. Solatube International, Inc: [www.solatube.com](http://www.solatube.com).
- B. Substitutions: See Section 01 6000 - Product Requirements.

## 2.02 TUBULAR SKYLIGHTS

- A. Tubular Skylights: Pre-manufactured daylighting system components assembled per site site-specific conditions.
1. All components made by one manufacturer.
  2. Non-Metal Parts: Flammability less than the following.
    - a. Roof-Top Components: Class B when tested in accordance with ASTM E108 or UL 790.
    - b. Smoke Developed Index: Maximum of 450, when tested in accordance with ASTM E84; or maximum rating of 75, when tested in accordance with ASTM D2843.
    - c. Combustibility - Light Transmitting Parts: Burning extent of 1 inch (25 mm) or less (ICC Class CC-1), when tested in accordance with ASTM D635 in the thickness intended for use.
  3. Thermal Movement: Fabricate to allow for thermal movement resulting from temperature differential from minus 30 to 180 degrees F (minus 34 to 82 degrees C) without damage to components, fasteners, or substrates.
- B. Roof Assemblies: Transparent, UV and impact resistant dome with flashing base supporting dome and top of tube.
1. Glazing: Polycarbonate plastic, 0.125 inch (3.2 mm) minimum thickness, classified CC1.
  2. Base: One piece, seamless, leak-proof flashing functioning as base support for dome and top of tube.
  3. Base Material: Sheet steel, galvanized, ASTM A653/ A653M, 24 gage, 0.0239 inch (0.61 mm) thick, minimum.
  4. Base Height: \_\_\_\_\_ inches (8 mm) and as recommended by manufacturer to suit roof penetrations indicated.
  5. Dome Ring: Attached to top of base section; 0.090 inch (2.3 mm) nominal thickness injection molded high impact ABS; to prevent thermal bridging between base flashing and tubing and channel condensed moisture out of tubing; weather seal of medium density pile weather stripping, meeting fire rating requirements described in this section.
  6. Reflective Tube: ASTM B209 (ASTM B209M) aluminum sheet, thickness between 0.015 inch (0.4 mm) and 0.020 inch (0.5 mm).
    - a. Interior Finish: Exposed interior surfaces with heat-laminated silver lining finished to provide high polished specular finish meeting AAMA designation M21C31A31. Laminated with themoset adhesive to provide permanent bond to substrate. Specular reflectance for visible spectrum (400 nm to 760 nm) greater than 97 percent. Total solar spectrum reflectance (400 nm to 2,500 nm) less than 93 percent.
    - b. Extensions and Angle Adapter Transitions: Manufacturer's standard types and angles, of same materials and sizes as tubes, as required to connect interior ceiling diffuser locations to skylight roof locations as shown for complete installation.
  7. Diffuser Assemblies: Supporting light transmitting surface at bottom termination of tube, with compression seal to minimize condensation and bug or dirt infiltration.
    - a. Diffuser: Prismatic type with extruded aluminum frame, ceiling mounted, concealing light duct. Injection molded acrylic plastic classified as CC2 Plexiglas. Thickness not less than 0.087 inch.
    - b. Diffuser: Suspended ceiling type, sized to fit ceiling grid, concealing light duct. Provide with square-to-round transition to light duct and injection molded acrylic plastic diffuser classified as CC2 Plexiglas.
    - c. Seals: Medium density pile weatherstripping and light density polyvinyl chloride foam tape or UV resistant EPDM rubber .

- d. Diffuser Trim: Edge and attachment trim for diffuser lens; injection molded high impact ABS.
  - e. Diffuser Shape in Lay-In Ceiling Grid: Square, 24 by 24 inches, to fit grid; metal transition box.
  - f. Lens: Flush frosted lens.
  - g. Lens Material: Polycarbonate plastic.
  - h. Ceiling Diffuser Seal: Closed cell polyethylene foam 3 pounds per cubic foot, and white polyvinyl chloride seal, but joint welded or EPDM rubber.
8. Wire Suspension Kit: Manufacturer's standard type as required to brace skylight assembly to the structure.
- a. Suspension Wire: Steel, annealed, galvanized finish, size and type for application and ceiling system requirement.

### 2.03 PERFORMANCE REQUIREMENTS

- A. Grade: AAMA/WDMA/CSA 101/IS.2/A440 requirements for specific tubular skylight:
  - 1. Product Type: Tubular Daylighting Device, Closed Ceiling (TDDCC).
  - 2. Performance Grade (PG): Equivalent to or greater than specified design pressure.
- B. Design Pressure (DP): In accordance with applicable codes.
- C. Flammability: Non-metal parts complying with the following:
  - 1. When used with the Dome Edge Protection Band, all domes meet fire rating requirements as described in the 2019 California Building Code. Provide the Dome Edge Protection Band on all units.
- D. Air Infiltration: Maximum 0.10 cu ft/min sq ft (0.5 L/sec sq m) per unit area of outside frame dimension at 6.27 psf (300 Pa) pressure differential when tested in accordance with ASTM E283.
- E. Water Resistance: No uncontrolled water leakage at 6.27 psf (300 Pa) pressure differential with water rate of 5 gallons/h/sf (206 L/h/sq m), when tested in accordance with ASTM E331; design to ensure that water will not accumulate inside assembly.
- F. VOC Limits for adhesives, sealants, fillers, primers and coatings . Comply with limits specified in related section.
- G. Designed in accordance with California Building Code Chapter 24, Section 2405.5, tested and labeled as complying with AAMA/WDMA/CSA 101/IS.2/A440
- H. Meet the following Area-Weighted Performance Rating values for plastic skylights in accordance with CEC Building Energy Efficiency Standards Tables 140.3-B or C:
  - 1. Maximum U-factor: 0.88.
  - 2. Maximum Solar Heat Gain Coefficient (SHGC): NR
  - 3. Minimum Visual Transmittance (VT): 0.64, rated using NFRC 203.
- I. Glazing material or diffuser with measured haze value greater than 90 percent, determined according to ASTM D1003, or other test method approved by the California Energy Commission.
- J. Provide tubular skylight system which maintains U.L. (Underwriters Laboratories) listing for electrical components, has been evaluated and approved by a product certification body that is certified to be in compliance with ISO Guide 65 to confirm that the product meets or exceeds the requirements of AAMA/WDMA/CSA 101/IS.2/A440, and maintains a current evaluation report.
  - 1. Specified Product "Solatube" ATI Report CCRR-0131.

## **2.04 ACCESSORIES**

- A. Anchorage Devices: Type recommended by manufacturer, exposed to view.
- B. Counterflashings: Same metal type and finish as tubular skylight frame.
  - 1. Flashings, trim, closures and other accessory items shall be formed of compatible metal sheet suitable for the application having a minimum thickness of 0.032 inches.
- C. Sealant: Polyurethane or copolymer based elastomeric sealant as provided or recommended by the manufacturer.
- D. Local Dimmer Control: Manufacturer's standard "butterfly" type. Provide with dimmer switch and cable.
  - 1. Daylight Dimmer: Type D Electro-mechanically actuated daylight valve; for universal input voltages ranging between 90 and 277 V at 50 or 60 Hz; Maximum current draw of 50 ma per unit; controlled by low voltage, series Type T02: circuited, 4 conductor, 22 gauge cable; providing daylight output between 2 and 100 percent.
  - 2. Switch: Type SW, Manufacturer-specific low voltage DC DP/DT switch (white) required to operate Daylight Dimmer. Note: A maximum of 10 units can be connected to one switch.
  - 3. Cable: Type CA, Two conductor, 22 gauge, low voltage cable for multiple unit DC connections.

## **2.05 FABRICATION**

- A. Fabricate free of vial distortion and defects.
- B. Fabricate to achieve leakproof, weathertight assembly.
- C. Fabricate components to allow for expansion and contraction with minimum clearance and shim specing around perimeter of assembly.

## **PART 3 EXECUTION**

### **3.01 EXAMINATION**

- A. Verify existing conditions before starting work.
- B. Verify that openings and substrate conditions are ready to receive work of this section.

### **3.02 PREPARATION**

- A. Clean surfaces thoroughly prior to installation.
- B. Apply protective back coating on aluminum surfaces of skylights that will be in contact with cementitious materials or dissimilar metals.

### **3.03 INSTALLATION**

- A. Install in accordance with manufacturer's written instructions.
- B. Set roof assembly flashing in continuous bead of sealant.
- C. Locate ceiling diffuser assemblies as shown on reflected ceiling plans, avoid conflict with other ceiling-mounted elements.
- D. Verify location of roof dome elements as shown on roof plans. With written permission of Architect, adjust roof locations as required to avoid conflict with other roof-mounted elements structural framing or other attic elements as applicable.

- E. Provide reflective tube extensions and angle adapters as required to connect ceiling diffusers with roof domes. Install wire suspension to support and brace reflective tubes to meet manufacturer and code requirements.
- F. Seal joints exposed to weather in accordance with sealant manufacturer's written instructions.
- G. Conduct field test for water tightness; conduct water test in presence of Architect. Correct defective work and re-test until satisfactory.
- H. Install local dimmer control system and adjust for proper operation.

**3.04 CLEANING**

- A. Remove protective material from prefinished aluminum surfaces.
- B. Wash down exposed surfaces; wipe surfaces clean.
- C. Remove excess sealant.

**3.05 PROTECTION**

- A. Protect installed products until completion of project.
- B. B. Touch-up, repair or replace damaged products before Substantial Completion.

**3.06 DEMONSTRATION**

- A. Demonstrate proper operation of dimmer controls to Owner's representative and Architect.

**END OF SECTION**

## SECTION 08 7100

### DOOR HARDWARE

#### PART 1 GENERAL

##### 1.01 SUMMARY

- A. Section Includes:
  - 1. All door hardware required to complete the work as indicated on the drawings and as specified herein.
- B. Related Sections/Work Specified Elsewhere
  - 1. Section 08 1113 - Hollow Metal Doors and Frames
  - 2. Section 08 1416 - Flush Wood Doors
  - 3. Section 08 3613 - Overhead Sectional Doors
  - 4. Section 08 4313 - Aluminum Entrances and Storefronts
  - 5. Section 10 1400 - Signage

##### 1.02 REFERENCES

- A. CBC - California Building Code - (Title 24, Part 2, California Code of Regulations (CCR))
- B. ADAAG - Americans with Disabilities Act Accessibility Guidelines
- C. NFPA 80 - Standard for Fire Doors and Other Opening Protectives - National Fire Protection Association
- D. NFPA 252 - Standard Methods of Fire Tests of Door Assemblies - National Fire Protection Association
- E. ANSI A156.1 through A156.20 - American National Standards Institute hardware standards as applicable
- F. U.L. - Underwriters Laboratories, Inc.
- G. BHMA - Builders Hardware Manufacturers Association
- H. DHI - Door and Hardware Institute - "Keying Systems and Nomenclature" and mounting heights/locations procedures and standards

##### 1.03 SUBMITTALS

- A. Submit in accordance with Section 01 3300.
- B. Hardware Schedule
  - 1. Within 30 days following Notice of Award, submit a complete Schedule of Hardware to Architect for review. Schedule criteria:
    - a. Prepare in Door and Hardware Institute (DHI) vertical format only. Horizontal schedules will be rejected.
    - b. Include index of doors, listing door number, page and heading number for each door listed.

- c. Include a legend of abbreviations, symbols, finishes and manufacturers.
  - d. Schedule each hardware item with quantity, type, manufacturer's model number, size/handing as applicable, screws/fasteners, finish, manufacturer's name and any additional information required for proper installation/operation.
  - e. List hardware for each door in groups, referencing the same group numbers and numerical group sequence as specified in 3.06 HARDWARE SCHEDULE.
  - f. Include in each hardware group/heading, the door number/location, door and frame types, material, size, thickness, fire rating and any additional door and frame information required for proper installation/operation of hardware.
- C. Review and approval of the Hardware Schedule by Architect does not absolve Contractor of responsibility for missing and/or incorrect items.
- D. When requested, provide the District/Architect, copies of purchase orders showing the dates hardware orders were placed with the factories.
- E. Product Data: Include catalog cut sheets on each type of hardware scheduled to include pictures/drawings, specifications and/or data sheets.
- F. Samples
1. Provide physical samples of hardware as requested by Architect.
  2. Samples will be returned upon request.
  3. Contractor is responsible for cost of samples.
- G. Operations and Maintenance Data
1. At contract closeout, provide District with 2 copies of an "Owners Operation and Maintenance Manual". The manual to consist of a hard cover, three-ring binder with the manual's title and project name listed on the outside, front cover. The manual to include:
    - a. Maintenance data for each item of hardware.
    - b. Manufacturer's installation instructions for each hardware item.
    - c. Name, address and phone number of the local representative for each product manufacturer.
    - d. Parts list for each product.
    - e. Copy of final hardware schedule to include all items listed in 1.03 SUBMITTALS, B. and E.
    - f. Manufacturer's warranty for each product.

#### **1.04 QUALITY ASSURANCE/REGULATORY REQUIREMENTS**

- A. Substitutions
1. Provide manufacturers of products listed in 2.01 MANUFACTURERS.
  2. Substitution requests to be made only in writing and no later than 10 days prior to bid opening.
  3. Substitutions will not be allowed after the bid.
- B. Supplier Qualifications
1. Hardware supplier to be a recognized finish hardware supplier, regularly engaged in contracting work, who has been furnishing projects of this size and scope in the project's vicinity for a period of not less than 5 years.
  2. The firm must have warehousing facilities and a sufficient staff to accommodate a project of this size and scope.
  3. The supplier must have in his employ a certified Architectural Hardware Consultant



(AHC) who is available at reasonable times during the course of the project for consultation with District, Architect and Contractor.

4. The supplier must be an authorized factory distributor of the key system specified.

C. Installer Qualifications

1. Hardware installer must have at least 2 years' experience in installing all types of finish hardware with specific experience in hardware installation on a project of this type and scope.

D. Fire Rated Doors and Frames

1. Provide hardware for fire rated doors and frames in compliance with positive pressure standard NFPA 252 or UL 10C, current edition of NFPA 80 and local building/fire code requirements. Provide only hardware that has been fire tested and positive pressure listed by Underwriters Laboratories (UL) or Warnock Hersey International (WHI) for types and sizes of doors specified and complies with "Fire Door Assembly" codes and requirements of door and frame labels.
2. Provide manufacturer's certificate of compliance or other documentation for each hardware item required to comply with positive pressure standard NFPA 252 or UL 10C.
3. Where emergency exit devices are required on fire rated doors, provide UL or WHI label on exit devices indicating "Fire Exit Hardware".
4. Install closing (self-closing or automatic closing) device on every fire door bearing fire labels.

E. Exit Doors

1. Doors shall be operable from the inside with "non-grasping" trim that does not require the use of a key or any special knowledge.

**1.05 DELIVERY, STORAGE AND HANDLING**

A. Marking and Packaging

1. Package each hardware item individually in manufacturer's original box/package.
2. Mark all packages with respective door, room, hardware heading and hardware set number.

B. Delivery

1. Deliver all hardware to jobsite unless otherwise directed by Contractor or specified herein.

C. Storage

1. Store all hardware in a dry, secured, enclosed area that is not subject to any corrosive elements that could damage the operation or appearance of the product.

**1.06 COORDINATION**

A. Templates

1. Distribute door hardware templates for doors, frames and other work specified to be factory prepared for hardware installation.
2. Review shop drawings of other work to confirm that adequate provisions are made for locating and installing door hardware with requirements specified herein.

**1.07 WARRANTY**

- A. Product Warranties
  - 1. Butt Hinges: Lifetime
  - 2. Continuous Hinges: Lifetime
  - 3. Locksets: 7 years
  - 4. Exit Devices: 10 years
  - 5. Surface Closers: 30 years
  - 6. Remaining hardware warranted for a minimum period of 2 years. The manufacturer’s specific product warranty, if greater than 2 years, shall take precedence.
- B. Manufacturer’s product warranty to commence from date of substantial completion. The manufacturer is responsible for re-installation of defective product during the warranty period.

**1.08 MAINTENANCE**

- A. Tools and Instructions
  - 1. Provide District at contract closeout, any specialized tools and maintenance instructions required for Owner’s adjustment, maintenance, removal and replacement of door hardware.

**PART 2 PRODUCTS**

**2.01 MANUFACTURERS**

- A. Provide hardware from listed manufacturers. To match existing District / Campus design, function and security / keying system, provide only the specified manufacturer of scheduled hardware where “Matches Existing” is listed. Refer to 1.04, A. for substitutions.

<u>HARDWARE ITEM</u>	<u>SPECIFIED MANUFACTURER</u>	<u>APPROVED EQUALS</u>
Hinges - Butts	HAG Hager	Mckinney, PBB, Stanley, Bommer, Ives or approved equal
Locksets, Latchsets, Cylinders	SCH Schlage	Matches Existing
Exit Devices, Removeable Mullions	VON Von Duprin	Matches Existing
Closers	LCN	Matches Existing
Protective Plates, Stops, Flush Bolts, Misc.	ROC Rockwood	Burns, Trimco, Ives, Glynn-Johnson or approved equal
Overhead Stops and Holders	ABH Architectural Builders Hardware	Glynn-Johnson or approved equal
Thresholds, Sweeps, Seals	PEM Pemko	Zero, Reese, National Guard or approved equal

**2.02 MATERIALS**

- A. Screws and Fasteners
  - 1. Install all hardware only with screws and fasteners furnished with hardware.
  - 2. Where a specific type of hardware is packaged by the manufacturer with “screws and fasteners by others”, install hardware with manufacturer’s recommended type(s).
  - 3. Finish to match hardware.

B. Hinges (butts)

1. Unless otherwise specified, furnish full mortise, template type butts with non-rising loose pins.
2. Furnish Hager as specified or approved equal as listed in 2.01, A. Provide:
  - a. 4.5 x 4.5 size for doors up to 3'0" wide.
  - b. 5 x 4.5 size for doors 3'1" and wider.
  - c. Three hinges for doors less than 7'6" tall and four hinges for doors 7'6" tall and greater.
  - d. Exterior, out-swinging door hinges in non-ferrous material with stainless steel, Non Removable Pin (NRP).
  - e. Interior hinges in wrought steel, polished and plated to match specified finish of other hardware. NRP at all out-swinging doors with keyed locksets.
  - f. Hinges of sufficient width, where required to clear frame and trim, to allow door to open 180 degrees.

C. Locks

1. Except where otherwise specified, furnish all locksets, latchsets, cylinders and component parts by Schlage as specified. Provide:
  - a. Lock series and trim/design as specified.
  - b. Locksets less cylinders.
  - c. Mortise cylinders and rim cylinders less cores.
  - d. Box strikes as required by frame types with sufficient length lip to prevent latch bolt from damaging trim.

D. Cylinders and Cores

1. Permanent cylinders/cores provided by the District.

E. Exit Devices

1. Conform to ANSI A156.3 Grade 1 Standard.
2. Comply with CBC 309.4 Operation: The force required to activate operable parts...push bar force required to retract latch...shall be 5 pounds maximum.
3. Furnish Von Duprin as specified.

F. Closers

1. Comply with CBC opening force requirements.
  - a. Interior non-rated doors - 5 lbs.
  - b. Exterior doors - 5 lbs.
  - c. Fire doors to have minimum opening force allowable by the appropriate authority having jurisdiction, not to exceed 15 lbs.
2. Surface Closers
  - a. Conform to ANSI A156.4 Grade 1 Standard. Furnish LCN as specified. Provide:
    - 1). Non-handed type that allows 180-degree door opening.
    - 2). Drop plates, back plates, brackets, mortise shoes, spacer blocks and long arms as required.
    - 3). Parallel arm closers with heavy-duty arm (EDA).
    - 4). Multi-size, power adjustable type with independent latch speed, sweep speed and back check cushioning valve controls.

G. Protective Plates

1. Furnish Rockwood kick plates as specified or approved equal listed in 2.01, A. Provide:
  - a. .050 thick.

- b. Beveled 4 edges.
- c. Sizes specified.

H. Stops and Holders

- 1. Furnish Rockwood as specified or approved equal listed in 2.01, A.
- 2. Where conditions will not allow installation of wall or floor stops as specified in 3.02 INSTALLATION, furnish overhead stop ABH 9000 series.

I. Thresholds, Sweeps and Seals

- 1. Furnish Pemko as specified or approved equal listed in 2.01, A.
- 2. Provide per plan details and as specified in 3.06 HARDWARE SCHEDULE.
- 3. Thresholds shall not exceed ½" in height with a slope no greater than 1:2.
  - a. Furnish with appropriate screws and anchors for floor material.

J. Silencers

- 1. For frames without seals, provide push-in type silencers. Self-adhesive type is not allowed. Provide:
  - a. Pairs of doors: 2 each
  - b. Single doors: 3 each

K. Miscellaneous Hardware

- 1. Provide remaining hardware items as specified in 3.06 HARDWARE SCHEDULE. The manufacturers and model numbers listed establish design, function and quality requirements.

**2.03 FINISHES**

- A. Provide finishes specified in 3.06 HARDWARE SCHEDULE. BHMA finish designation indicates base metal as well as finish.

**2.04 KEYING**

- A. Permanent cores/cylinders keying by the District.
- B. Installation of cores/cylinders by the Contractor.

**PART 3 EXECUTION**

**3.01 EXAMINATION**

- A. Prior to installation of hardware, examine doors, frames and related items for defects or other conditions that would prevent the proper installation and operation of specified hardware. Do not proceed with hardware installation until deficiencies are corrected.

**3.02 INSTALLATION**

- A. Install hardware in accordance with manufacturer's instructions.
- B. Surface Closers
  - 1. Install inside rooms, in stairwells and inside vestibules. Do not mount closers in corridors except at exterior doors that open off a corridor.
  - 2. Install with sex nuts and bolts.
  - 3. Template for maximum degree of opening:

- a. Parallel arm: 180 degrees
  - b. Regular arm: Maximum degree listed by manufacturer
    - 1). Where adjacent wall, obstruction or closer stop type arm will not permit maximum degree of opening, install closers to allow the maximum degree of opening allowed by the stop arm or before door contacts wall or obstruction. In no instance are closers to be templated for less than 90 degree opening.
  4. Adjust closers per 2.02, F. and comply with closer sweep requirements so that from an open position of 90 degrees, the time required to move door to a position 12 degrees from the latch is 5 seconds minimum.
- C. Exit Devices
1. Install with sex nuts and bolts.
- D. Permanent Cylinders/Cores
1. Contactor to install cylinders/cores provided by the District.
- E. Kick Plates
1. Install plates on push side of door unless otherwise specified.
  2. Install only with screws furnished.
  3. Align centered between door edges and with bottom edge flush with door bottom.
  4. Plates are to fit flat against the face of the door without any modification to the plate.
  5. Replace plates of incorrect size that encroach on glass area, hang below door bottom or extend beyond door edges.
- F. Stops
1. Floor Stops:
    - a. Install in a position that permits maximum door swing but does not exceed 4" from wall.
    - b. Furnish stops of proper height to engage door.
    - c. Position to contact the door at a point 6 inches from the latch edge, but no further than 1/3 the door width as measured from the latch edge.
  2. Wall Stops:
    - a. Fasten to solid blocking/backing.
    - b. Install at height that will engage operating trim/levers.
- G. Thresholds
1. Set in full bed of sealant complying with requirements specified in Division 07 Section "Joint Sealants".
  2. Secure to concrete with flat head machine screws and expansion anchors.
- H. Seals
1. As required, notch jamb seals around hardware items (closer arms, strikes, etc.).
- I. Fasten miscellaneous wall-mounted hardware to solid blocking/backing.
- J. Unless otherwise specified, all hardware mounting heights shall be per drawings, CBC and/or Door and Hardware Institute (DHI) mounting location standards. Operating/opening hardware shall be installed between 34" minimum and maximum 44" centerline above finished floor.

### 3.03 FIELD QUALITY CONTROL

- A. After hardware installation has been completed, Architect, District’s representative and/or project inspector shall:
  - 1. Visually inspect installed hardware to determine compliance with the approved hardware and keying schedules.
  - 2. Cycle doors to determine proper operation of hardware.

**3.04 ADJUSTING AND CLEANING**

- A. At the end of project, clean and make final adjustments to all hardware. Where hardware is found defective, repair or replace as directed.

**3.05 PROTECTION**

- A. Provide proper care and protection for all hardware items and finishes until completion of project.

**3.06 HARDWARE SCHEDULE**

- A. The following is a schedule of hardware to be furnished for this work. The listed material to conform throughout with the requirements of the foregoing specification.

HW-1

Each pair to have

2	Continuous Hinges	SL11HD	628	SEL
1	Set Automatic Flush Bolts	2842	626	ROC
1	Dust Proof Strike	570	626	ROC
1	Coordinator	2600 series x 2 mounting brackets required	600	ROC
1	Entrance Lockset	ND92LD RHO	626	SCH
2	Closers	4040XP EDA	689	LCN
2	Floor Stops	463	630	ROC
1	Threshold	Per detail		PEM
2	Sweeps	29326CNB		PEM
1	Set Seals	By door mfr.		
1	Astragal	By door mfr.		

HW-2

Each door to have

1	Continuous Hinge	SL11HD	628	SEL
1	Entrance Lockset	ND92LD RHO	626	SCH
1	Closer	4040XP EDA	689	LCN
1	Floor Stop	463	630	ROC
1	Threshold	Per detail		PEM
1	Sweep	29326CNB		PEM
1	Set Seals	By door mfr.		

HW-3

Each door to have

1	Continuous Hinge	SL11HD	628	SEL
1	Entrance Lockset	ND92LD RHO	626	SCH
1	Closer/Stop	4040XP SCUSH	689	LCN
1	Threshold	Per detail		PEM
1	Sweep	29326CNB		PEM
1	Set Seals	By door mfr.		

HW-4

Each pair to have

	Hinges	BB1191	630	HAG
2	Flush Bolts	555	626	ROC
1	Dust Proof Strike	570	626	ROC
1	Storeroom Lockset	ND96LD RHO	626	SCH
2	Floor Stops	463	630	ROC
1	Threshold	Per detail		PEM
2	Sweeps	29326CNB		PEM
1	Set Seals	S88GR	Gray	PEM
1	Welded Steel Astragal	By door mfr./supplier		

HW-5

Each door to have

	Hinges	BB1191	630	HAG
1	Storeroom Lockset	ND96LD RHO	626	SCH
1	Overhead Stop	9000 series	630	ABH
1	Threshold	Per detail		PEM
1	Sweep	29326CNB		PEM
1	Set Seals	S88GR	Gray	PEM

HW-6

Each door to have

	Hinges	BB1279	652	HAG
1	Office Lockset	ND91LD RHO	626	SCH
1	Floor Stop	481	626	ROC

HW-7

Each door to have

	Hinges	BB1279	652	HAG
1	Office Lockset	ND91LD RHO	626	SCH
1	Closer	4040XP REG	689	LCN
1	Kick Plate	K1050 10" x 2" LDW	630	ROC
1	Floor Stop	481	626	ROC

HW-8

Each door to have

	Hinges	BB1279	652	HAG
1	Privacy Latchset	ND40S RHO	626	SCH
1	Kick Plate	K1050 10" x 2" LDW	630	ROC
1	Floor Stop	481	626	ROC
1	Set Seals	S88GR	Gray	PEM

HW-9

Each door to have

	Hinges	BB1279	652	HAG
1	Privacy Indicator 'Occupied' Lockset	LV9456P x less core 06A x L283-722	626	SCH
1	Closer	4040XP REG	689	LCN
1	Kick Plate	K1050 10" x 2" LDW	630	ROC
1	Floor Stop	481	626	ROC
1	Set Seals	S88GR	Gray	PEM

HW-10

Each door to have

	Hinges	BB1279	652	HAG
1	Entrance Lockset	ND92LD RHO	626	SCH
1	Kick Plate	K1050 10" x 2" LDW	630	ROC
1	Floor Stop	481	626	ROC

HW-11

Each door to have

	Hinges	BB1279	652	HAG
1	Office Lockset	ND91LD RHO	626	SCH
1	Kick Plate	K1050 10" x 2" LDW	630	ROC
1	Closer/Holder	4040XP HEDA	689	LCN
1	Floor Stop	481	626	ROC

HW-12

Each pair to have

	Hinges	BB1279	652	HAG
2	Flush Bolts	557	626	ROC
1	Dust Proof Strike	570	626	ROC
1	Office Lockset	ND91LD RHO	626	SCH
2	Kick Plates	K1050 10" x 1 1/2" LDW	630	ROC
2	Overhead Stops	9000 series	630	ABH

HW-13



Each door to have

Hinges	BB1279	652	HAG
1 Privacy Indicator "Occupied" Lockset	LV9456P x less core 06A x L283-722	626	SCH
1 Closer/Stop	4040XP SCUSH	689	LCN
1 Kick Plate	K1050 10" x 2" LDW	630	ROC
1 Set Seals	S88GR	Gray	PEM

HW-14

Each pair to have

Hinges	BB1279	652	HAG
2 Flush Bolts	557	626	ROC
1 Dust Proof Strike	570	626	ROC
1 Storeroom Lockset	ND96LD RHO	626	SCH
2 Kick Plates	K1050 10" x 1 1/2" LDW	630	ROC
2 Overhead Stops	9000 series	630	ABH

HW-15

Each pair to have

2 Continuous Hinges	SL11HD	628	SEL
1 Exit Device	CDSI-AX99NL	626	VON
1 Exit Device	CDSI-AX99DT	626	VON
1 Removeable Mullion	KR4954 x 154	689	VON
1 Storage Mount	54		VON
3 IC Mortise Cylinders	FSIC cylinder x less core	626	SCH
1 IC Rim Cylinder	FSIC cylinder x less core	626	SCH
2 Closers/Stops/holders	4040XP SHCUSH	689	LCN
1 Threshold	Per detail		PEM
2 Sweeps	29326CNB		PEM
1 Set Seals	By door mfr.		
1 Astragal	By door mfr.		

HW-16

Each door to have

1 Continuous Hinge	SL11HD	628	SEL
1 Exit Device	CDSI-AX99NL	626	VON
1 IC Rim Cylinder	FSIC cylinder x less core	626	SCH
1 IC Mortise Cylinder	FSIC cylinder x less core	626	SCH
1 Closer/Stop/Holder	4040XP SHCUSH	689	LCN
1 Threshold	Per detail		PEM
1 Sweep	29326CNB		PEM
1 Set Seals	By door mfr.		

HW-17

Each door to have

Hinges	BB1279	652	HAG
1 Office Lockset	ND91LD RHO	626	SCH
1 Closer/Stop/Holder	4040XP SHCUSH	689	LCN
1 Kick Plate	K1050 10" x 2" LDW	630	ROC

HW-18

Each pair to have

Hinges	BB1191	630	HAG
1 Set Automatic Flush Bolts	2842	626	ROC
1 Dust Proof Strike	570	626	ROC
1 Coordinator	2600 series x 2 mounting brackets required	600	ROC
1 Entrance Lockset	ND92LD RHO	626	SCH
2 Closers/Stops/Holder	4040XP SHCUSH	689	LCN
2 Kick Plates	K1050 10" x 1 1/2" LDW	630	ROC
1 Threshold	Per detail		PEM
2 Sweeps	29326CNB		PEM
1 Set Seals	S88GR		Gray PEM
1 Welded Steel Astragal	By door mfr./supplier		

HW-19

Each door to have

Hinges	BB1279	652	HAG
1 Passage Latchset	ND10S RHO	626	SCH
1 Overhead Stop	9000 series	630	ABH

**END OF SECTION**



# ND Series

Grade 1 cylindrical locks

Mechanical  
Wired electrified  
Wireless electronic



Designs and finishes

# Lever designs and finishes

Athens (ATH)<sup>2</sup>

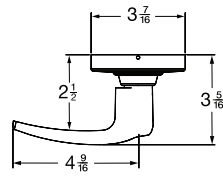

Mechanical

Wired electrified

Wireless electronic

Sparta (SPA)<sup>1,2</sup>

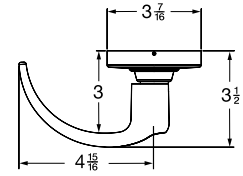

Mechanical

Wired electrified

Wireless electronic

Rhodes (RHO)<sup>1,2</sup>

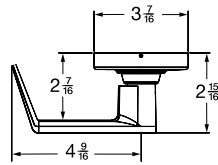

Mechanical

Wired electrified

NDE wireless electronic

Tubular (TLR)<sup>1,2</sup>

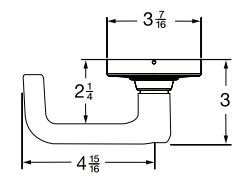

Mechanical

Wired electrified

Wireless electronic

Omega (OME)<sup>1</sup>

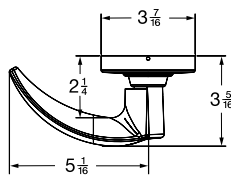

Mechanical

Wired electrified

Wireless electronic

Latitude (LAT)

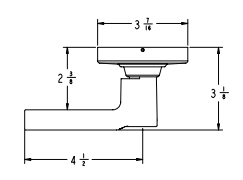
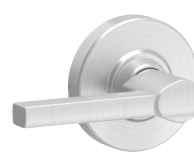

Mechanical

Wired electrified

Wireless electronic

Broadway (BRW)

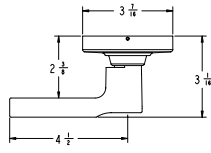
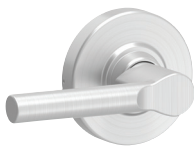

Mechanical

Wired electrified

Wireless electronic

Longitude (LON)

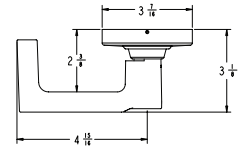
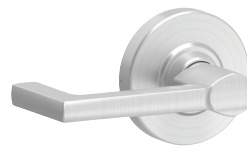

Mechanical

Wired electrified

Wireless electronic

Boardwalk (BWK)

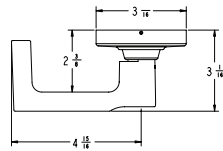
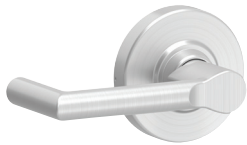

Mechanical

Wired electrified

Wireless electronic

All levers comply with the Americans with Disabilities Act (ADA).

- 1 Boardwalk, Longitude, Omega, Rhodes, Sparta and Tubular levers comply with California State code for return within 1/2" of door face.
- 2 Athens, Rhodes, Sparta and Tubular levers support cylinders from other manufacturers, see cylinder section on page 24 for details.

Finish options									
Color	Bright brass	Satin brass	Satin bronze	Oil rubbed bronze	Satin nickel	Matte black	Bright chrome	Satin chrome	Aged bronze
ANSI/BHMA number	605	606	612	613	619	622	625	626/626AM	643e
US number	US3	US4	US10	US10B	US15	US19	US26	US26D	US11
Mechanical	■	■	■	■	■	■	■	■	■
Wired electrified	■	■	■	■	■	■	■	■	■
Wireless electronic	■	■	■	—	■	■	■	■	■

Product information and specifications contained in this catalog are subject to change without notice. Please consult the factory.

**ND Series mechanical lock**  
**Keyless function list**

**Legend**

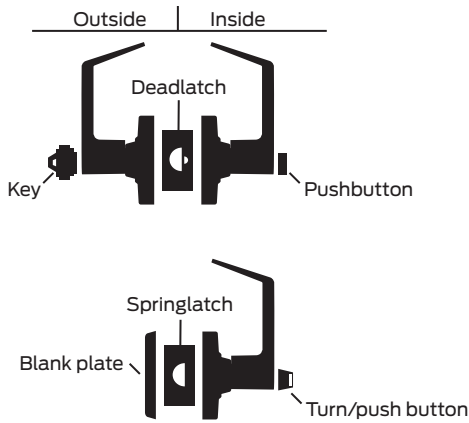

Schlage ANSI

**ND10S F75**  
**Passage latch**

- Both levers always unlocked.

Schlage ANSI

**ND12D F89**  
**Exit lock**

- Outside lever always fixed.
- Inside lever always free for immediate egress.

Inside

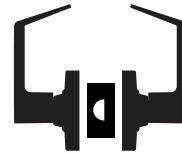

Available with RX

Outside

Inside

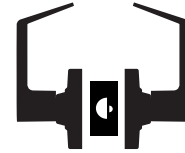

Available with RX

Schlage ANSI

**ND25D -**  
**Exit lock**

- Blank plate outside.
- Inside lever always free for immediate egress.

Outside

Inside



Schlage ANSI

**ND40S F76**  
**Bath/bedroom privacy lock**

- Push-button locking.
- Unlocked from outside with a small screwdriver.
- Turn inside lever or close door to release button.
- Inside lever always free for immediate egress.

Outside

Inside



Schlage ANSI

**ND44S -**  
**Hospital privacy lock**

- Push-button locking.
- Unlocked from outside by turning emergency turn-button.
- Turn inside lever or close door to release button.
- Inside lever always free for immediate egress.

Outside

Inside

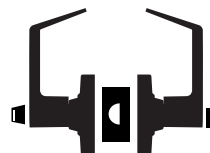

Schlage ANSI

**ND170 -**  
**Single dummy trim**

- Dummy trim for one side of door.
- Used for door pull or as matching inactive trim.

Outside/Inside



**ND Series mechanical lock**  
**Vandlgard™ function list**

Vandlgard™ trim is specifically designed for highly abusive environments. The outside lever rotates freely up and down when locked, limiting the ability of vandals to apply excessive force to the chassis

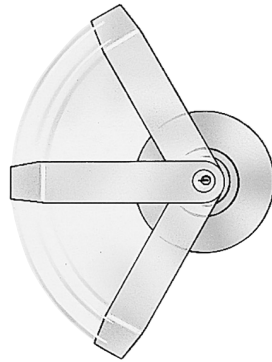

Schlage ANSI

**ND91PD F82**

**Entrance/office lock**

- Push-button locking.
- Push-button disengages outside lever until unlocked with key or by turning inside lever.
- Vandlgard allows outside spindle to disengage from latch when locked.
- Inside lever always free for immediate egress.

Outside Inside

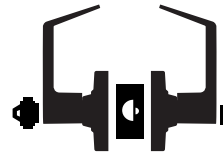

Schlage ANSI

**ND92PD F109**

**Entrance lock**

- Turn/push-button locking: Pushing and turning button disengages outside lever, requiring using of key until button is manually unlocked.
- Push-button locking: Pushing button disengages outside lever until unlocked by key or by turning inside lever.
- Vandlgard allows outside spindle to disengage from latch when locked.
- Inside lever always free for immediate egress.

Outside Inside

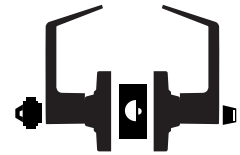

Schlage ANSI

**ND93PD F88**

**Vestibule lock**

- Latch retracted by key from outside when outside lever is disengaged by key in inside lever.
- Vandlgard allows outside spindle to disengage from latch when locked.
- Inside lever always free for immediate egress.

Outside Inside

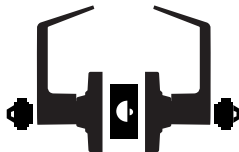

Schlage ANSI

**ND94PD F84**

**Classroom lock**

- Outside lever disengaged and unlocked by key.
- Vandlgard allows outside spindle to disengage from latch when locked.
- Inside lever always free for immediate egress.

Outside Inside

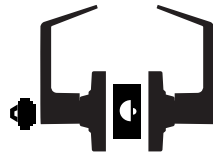

Schlage ANSI

**ND95PD -**

**Classroom security lock**

- Key in either lever locks or unlocks outside lever.
- Vandlgard allows outside spindle to disengage from latch when locked.
- Inside lever always free for immediate egress.

Outside Inside



Schlage ANSI

**ND96PD F86**

**Storeroom lock**

- Outside lever always disengaged.
- Entrance by key only.
- Vandlgard allows outside spindle to disengage from latch when locked.
- Inside lever always free for immediate egress.

Outside Inside

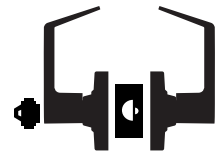

Available with RX

## Ordering instructions

### Example

	Function + cylinder	Outside		Inside		Door				
		Lever	Finish	Lever	Finish	Latch	Strike	Thickness	Extension	Dimension
Mechanical	ND53PD	ATH	626							
Wired electrified	ND80EUL	RHO	605	SPA	619	14-048	10-013	214	EE	118
Wireless electronic	NDE80BD	SPA	619							

### Detail

Function	Mechanical: See pages 12-17 Wired electrified: See pages 18-19 Wireless electronic: NDE80; see pages 20-21
Cylinder	Standard: P (Patented Everest 29) L (less cylinder) C (less double cylinder) Z (Everest SL) Full size Interchangeable (FSIC): R (FSIC, Patented Everest29) J (FSIC, less core) T (FSIC, Construction Core) Small format Interchangeable: GD (SFIC, Patented Everest 29) BD (SFIC, less core) BDC (SFIC, disposable core) HD (SFIC, construction core)
	For non-Schlage cylinders please see page 24
Outside lever	ATH (Athens), RHO (Rhodes), SPA (Sparta), TLR (Tubular), OME (Omega), LAT (Latitude), LON (Longitude), BRW (Broadway), BRK (Boardwalk) Note: Specify tactile as: 8AT (Athens), 8RO (Rhodes), 8SP (Sparta), 8TR (Tubular), 8LT (Latitude), 8LN (Longitude), 8BY (Broadway), 8BK (Boardwalk)
Outside finish	605 Bright brass (US3) 606 Satin brass (US4) 612 Satin bronze (US10) 613 Oil rubbed bronze (US10B) <sup>1</sup> 619 Satin nickel (US15) 622 Matte black (US19) 626 Satin chrome (US26D) 626AM Satin chrome anti-microbial 625 Bright chrome (US26) 643e Aged bronze (US11)
	<sup>1</sup> Not available NDE wireless electronic
Inside lever	Specify only if different from outside lever. Same options as outside lever.
Inside finish	Specify only if different from outside finish. Same options as outside finish.
Latch	Specify only if different from standard latch; see page 24 for options.
Strike	Specify only if different from standard strike; see page 24 for options.
Door thickness	Specify only if outside standard door range (1 <sup>5</sup> / <sub>8</sub> "-2 <sup>1</sup> / <sub>8</sub> "). Extended door thickness not available NDE wireless electronic.
Extension	Specify only for doors 2 <sup>1</sup> / <sub>8</sub> " or greater. Example: EE = Extended Equally, EI = Extended Inside, EO = Extended Outside, ED = Extended Differently
Dimension	Specify only for non-standard strike lip length.
Options	Specify any additional requirements or options. Example: KA = Keyed Alike, KD = Keyed Different, Obit, etc.



# L Series

Grade 1 mortise locks

- Mechanical
- Wired electrified
- Wireless electronic
- Multi-point













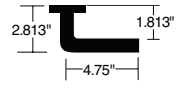

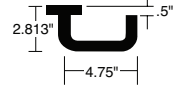

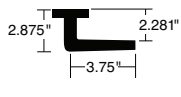



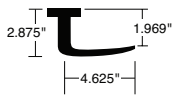



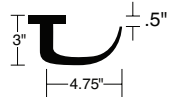

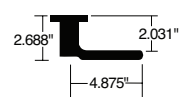
Designs and finishes

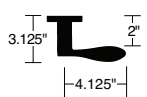
# The Standard Collection

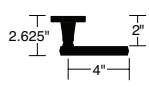
The Standard Collection levers can be paired with exit devices and locks from our trusted Schlage and Von Duprin brands. And, they are built to the same exacting standards. Our Standard Collection levers offer a more traditional style that is appropriate for use in a number of commercial applications.

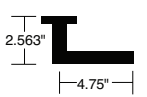
<p><b>01</b> ♿</p> 		<p><b>02</b> ♿</p> 		<p><b>03</b> ♿</p> 	
<p><b>05</b> ♿</p> 		<p><b>06</b> ♿</p> 		<p><b>07</b> ♿</p> 	
<p><b>12</b> ♿</p> 		<p><b>17</b> ♿</p> 		<p><b>18</b> ♿</p> 	
<p><b>Accent</b> ♿</p> 		<p><b>Asti</b> ♿</p> 		<p><b>Latitude</b> ♿</p> 	

Note: Levers shown with Schlage L Series mortise "A" rose. Knobs shown with rose that is unavailable in the L Series. Additional rose and escutcheon designs available.

## Trim and special accessories

### Escutcheons and roses

Three escutcheons and five roses are available to help to match the design and performance needed for your application.

#### Escutcheons



##### L full face

Specify by adding 'L' after lever design.

**Material:** Cold-forged brass, bronze or stainless steel

**Finishes:** 605, 606, 609, 612, 613, 619, 622, 625, 626, 629, 630, 643e

**Size:** 8" x 1 3/4" x 7/16"  
(203 mm x 44 mm x 11 mm)



##### L concealed

Specify by adding 'C' suffix to function and by adding 'L' after lever design.

**Material:** Cold-forged brass, bronze or stainless steel

**Finishes:** 605, 606, 609, 612, 613, 619, 622, 625, 626, 629, 630, 643e

**Size:** 8" x 1 3/4" x 7/16"  
(203 mm x 44 mm x 11 mm)



##### N full face

Specify by adding 'N' after lever design.

**Material:** Heavy wrought reinforced brass, bronze or stainless steel

**Finishes:** 605, 606, 609, 612, 613, 619, 622, 625, 626, 629, 630, 643e

**Size:** 8" x 2 9/16" x 7/16"  
(203 mm x 65 mm x 11 mm)

#### Roses

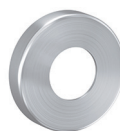

##### A rose

2 1/8" (54 mm) diameter  
Available for use on L Series knob and lever designs. Specify by adding 'A' after lever design

**Finishes:** 605, 606, 609, 612, 613, 619, 622, 625, 626, 629, 630, 643e

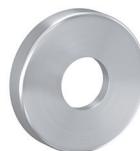

##### B rose

2 9/16" (65 mm) diameter  
Available for use on L Series knob and lever designs. Specify by adding 'B' after lever design.

**Finishes:** 605, 606, 609, 612, 613, 619, 622, 625, 626, 629, 630, 643e

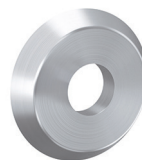

##### C rose

2 5/8" (66 mm) diameter  
Available for use on L Series knob and lever designs. Specify by adding 'C' after lever design.

**Finishes:** 605, 606, 609, 619, 622, 625, 626, 629, 630, 643e

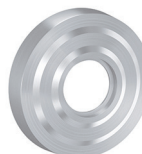

##### AVA rose

2 5/8" (66 mm) diameter  
Available for use on ACC lever, other levers upon request.

**Finishes:** 605, 606, 609, 619, 622, 625, 626, 643e

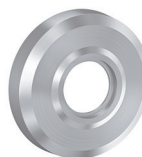









##### MER rose

2 5/8" (66 mm) diameter  
Available for use on MER lever, other levers upon request.

**Finishes:** 605, 606, 609, 619, 622, 625, 626, 643e

L Series mechanical lock functions

Single cylinder deadbolt functions







Schlage	ANSI	Schlage	ANSI	Schlage	ANSI	Schlage	ANSI
<b>L9456</b> <b>LV9456</b>	<b>F13</b>	<b>L9465</b>	<b>—</b>	<b>L9473</b>	<b>F21</b>	<b>L9480</b> <b>LV9480</b>	<b>—</b>
<b>Corridor lock</b>		<b>Closet/storeroom lock</b>		<b>Dormitory/bedroom lock</b>		<b>Storeroom lock with deadbolt</b>	
<ul style="list-style-type: none"> <li>Latchbolt retracted by lever/knob from either side</li> <li>Deadbolt actuation by key or thumbturn rotation</li> <li>Throwing deadbolt locks outside lever/knob</li> <li>Turning inside knob/lever retracts both deadbolt and latchbolt and unlocks outside lever/knob</li> <li>Inside lever always free for immediate egress</li> </ul>		<ul style="list-style-type: none"> <li>Latchbolt retracted by lever/knob from either side</li> <li>Deadbolt actuation by key</li> </ul>		<ul style="list-style-type: none"> <li>Latchbolt retracted by lever/knob from either side</li> <li>Deadbolt actuation by outside key or inside thumbturn</li> </ul>		<ul style="list-style-type: none"> <li>Latchbolt retracted by outside key or inside knob/lever</li> <li>Outside knob/lever always fixed</li> <li>Deadbolt actuation by outside key or inside thumbturn</li> <li>Inside knob/lever actuation retracts both deadbolt and latchbolt</li> <li>Auxiliary latch deadlocks latchbolt when door is closed</li> <li>Inside lever always free for immediate egress</li> </ul>	
							
Schlage	ANSI	Schlage	ANSI	Schlage	ANSI	Schlage	ANSI
<b>L9485</b> <b>LV9485</b>	<b>—</b>	<b>L9486</b> <b>LV9486</b>	<b>F15</b>	<b>L9486 x L583-375</b> <b>LV9486 x L583-375</b>	<b>—</b>	<b>L9496</b>	<b>—</b>
<b>Faculty/hotel/restroom lock</b>		<b>L/LV9485 with 09-611 "DO NOT DISTURB" indicator for rose trim</b>		<b>L/LV9485 with "OCCUPIED" indicator for rose trim</b>		<b>Privacy with 09-611 "OCCUPIED" indicator for rose trim</b>	
<ul style="list-style-type: none"> <li>Latchbolt retracted by outside key or inside knob/lever</li> <li>Outside knob/lever always fixed</li> <li>Deadbolt actuation by thumbturn</li> <li>All keys (except emergency and display keys) inoperative when deadbolt is thrown</li> <li>Inside knob/lever retracts both deadbolt and latchbolt</li> <li>Auxiliary latch deadlocks latchbolt when door is closed</li> <li>Inside lever always free for immediate egress</li> </ul>		<ul style="list-style-type: none"> <li>Latchbolt retracted by outside key or inside knob/lever</li> <li>Outside knob/lever always fixed</li> <li>Deadbolt actuation by thumbturn</li> <li>When deadbolt is thrown "DO NOT DISTURB" message is displayed and all keys (except emergency and display keys) become inoperative</li> <li>Inside knob/lever retracts both deadbolt and latchbolt</li> <li>Auxiliary latch deadlocks latchbolt when door is closed</li> <li>Inside lever always free for immediate egress</li> </ul>		<ul style="list-style-type: none"> <li>Latchbolt retracted by outside key or inside knob/lever</li> <li>Outside knob/lever always fixed</li> <li>Deadbolt actuation by thumbturn</li> <li>When deadbolt is thrown "OCCUPIED" message is displayed and all keys (except emergency and display keys) become inoperative</li> <li>Inside knob/lever retracts both deadbolt and latchbolt</li> <li>Auxiliary latch deadlocks latchbolt when door is closed</li> <li>Inside lever always free for immediate egress</li> </ul>		<ul style="list-style-type: none"> <li>Latchbolt retracted by knob/lever from either side</li> <li>Deadbolt actuation by outside key or inside thumbturn</li> <li>Thrown deadbolt displays "OCCUPIED" message and locks outside lever</li> <li>Inside knob/lever retracts both deadbolt and latchbolt and unlocks outside lever</li> <li>Inside lever always free for immediate egress</li> </ul>	
		 <small>DO NOT DISTURB</small>		 <small>OCCUPIED</small>		 <small>OCCUPIED</small>	

Trim and special accessories

# Thumbturns and indicators

Choose from these variations of thumbturn locks that help you meet the demands of specialized projects.

## Thumbturns

					
<b>Standard turn</b> 09-509	<b>ADA turn</b> 09-509 x L583-363 Available with all thumbturn-function L Series locks except L9463 and L463	<b>Coin turn</b> L283-124 For lock functions L9044 and L9444 with rose trim.	<b>Emergency button</b> K510-330 For lock functions L9040 and L9440	<b>Ligature resistant turn</b> 09-029	<b>Cylinder turn</b> 09-90x For L463 and L9463 classroom function deadlocks

## Indicators

The 180 degree visibility indicator offers unparalleled visibility and flexibility. The unique features of the indicator make it ideally suited for classroom security applications as well as traditional occupied/vacant applications.

- 2" x 1/2" display for easy viewing at a distance
- 180° window for visibility at any angle
- High-mount placement for quick assessment
- High contrast colors for ease of reading
- Available for over 30 functions, inside or outside of door (see Functions section for availability)
- Retrofit kit allows indicator upgrades to already installed L Series mortise locks
- Indicator text available in English or French

### N escutcheon indicators

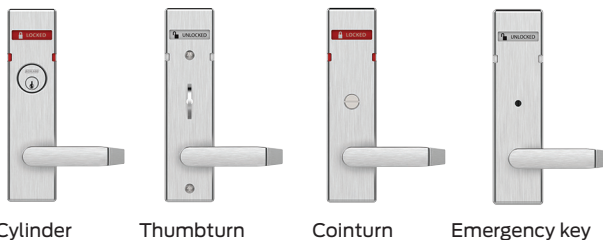



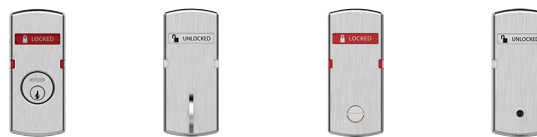

Cylinder      Thumbturn      Cointurn      Emergency key

### Sectional indicators



Cylinder      Thumbturn      Cointurn      Emergency key

	 LOCKED	 OCCUPIED	 DO NOT DISTURB	 UNLOCKED
Inside trim	L283-711	L283-712	L283-713	L283-714
Outside trim	L283-721	L283-722	L283-723	L283-724

## Legacy indicator



### Hotel occupancy indicator

09-611

For lock function L9486P, used with A or B roses on section trim. Three available messages: "OCCUPIED", "DO NOT DISTURB" or "LOCKED".

## L Series mechanical lock functions

### Legend

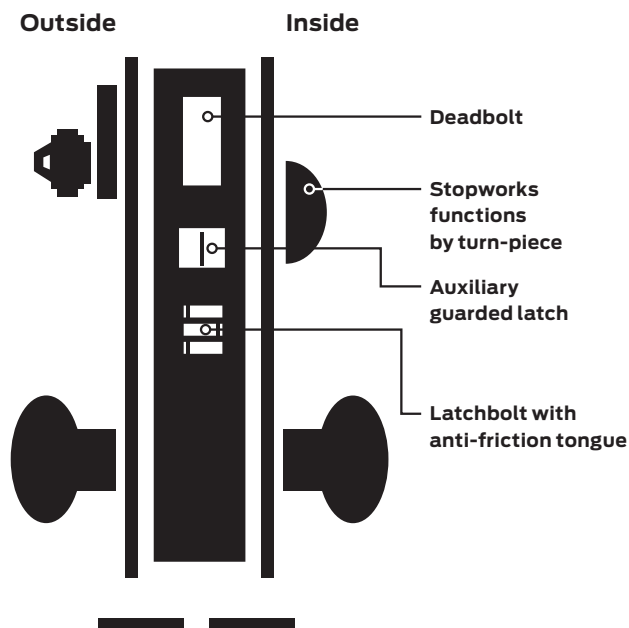

### Key

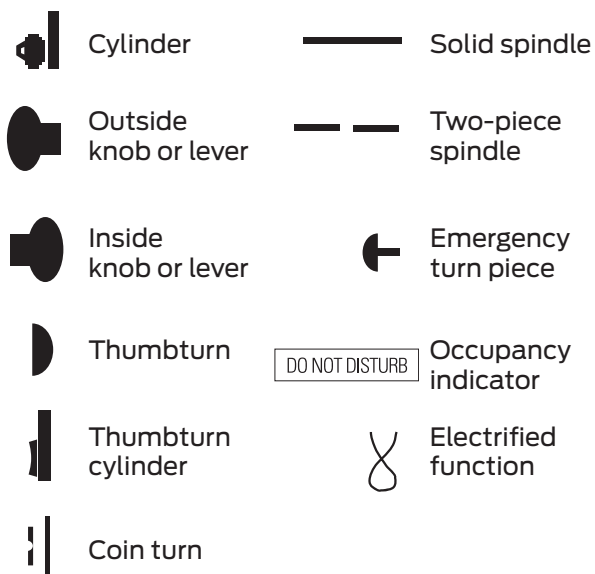

**LV** Vandlgard function allows exterior lever to rotate freely down, while remaining securely locked.

 180 degree messaging indicator available. See options section in price book for details.

### Product identification guide

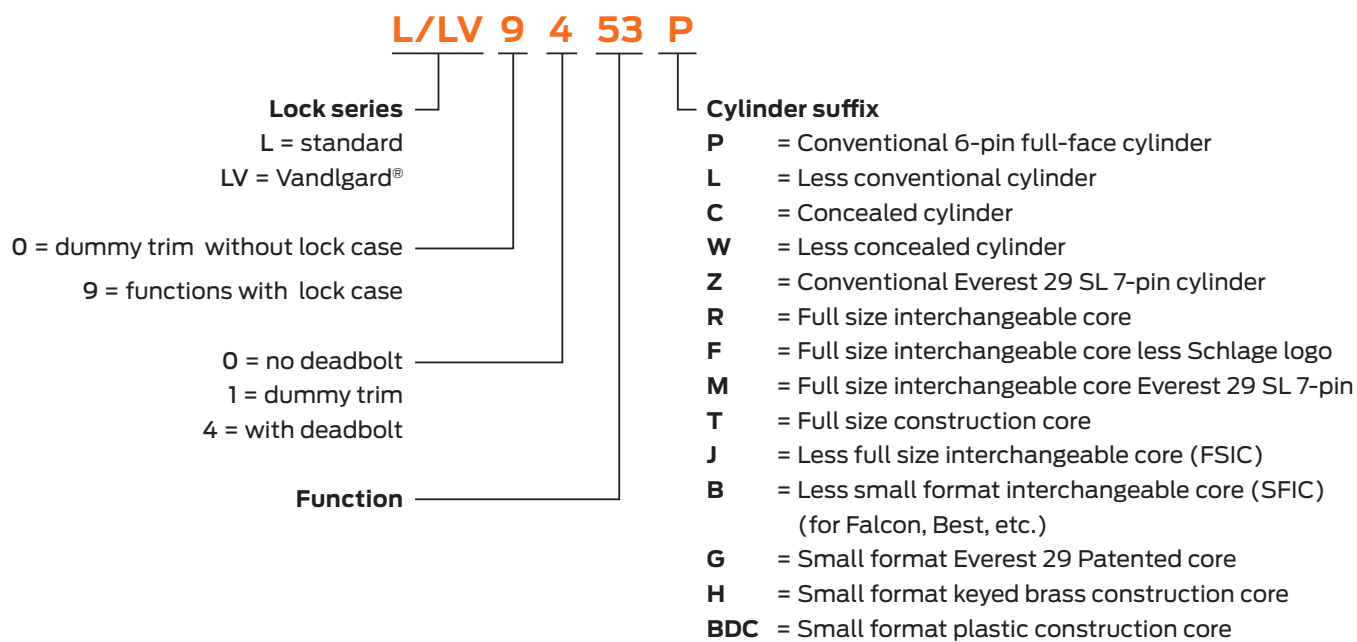

**VON DUPRIN®**

98/99™  
Series

Exit device



# 98/99 Rim exit device



The 299 Strike ships standard, optional strikes available

**98 and 99 Rim exit devices** for all types of single and double doors with mullion, UL listed for panic exit hardware. Devices are ANSI A156.3 – 2014 Grade 1. The 98 device has a smooth mechanism case and the 99 device has a grooved case. The rim device is non-handed except when the following device options are used: SD (special dogging), -2 (double cylinder) or SS (signal switch). See Opposite page for available outside trim and device functions. Covers stock hollow metal doors with 86 or 161 cutouts on single doors (may cover cutouts on pairs – consult template).

Hex key dogging comes standard on 98/99 Rim exit devices



**Finishes** – US3, US3A, US4, US4A, US10, US26, US26D, US26D-AM Antimicrobial, US28, 313, 315 & 643E. US15 and US32D available with 98 Series only.

## Specifications

Device functions	Device ships EO/DT/NL. Field selectable. For TP, K or L remove NL drive screw from device.	
Device lengths	3'	2'4" to 3' (711mm to 914 mm) Door size
	4'	2'10" to 4' (864 mm to 1219 mm) Door size
Device centerline from finished floor	39 <sup>13</sup> / <sub>16</sub> " (1011 mm) 39 <sup>11</sup> / <sub>16</sub> " (1008 mm) with mullion	
Center case dimensions	8" x 2 <sup>3</sup> / <sub>4</sub> " x 2 <sup>3</sup> / <sub>8</sub> " (203mm x 70mm x 60mm)	
Mechanism case dimensions	2 <sup>1</sup> / <sub>4</sub> " x 2 <sup>1</sup> / <sub>4</sub> " (57mm x 57mm)	
Projection	Pushbar neutral – 3 <sup>13</sup> / <sub>16</sub> " (97 mm) Pushbar depressed – 3 <sup>1</sup> / <sub>16</sub> " (78 mm)	
Latch bolt	Deadlocking, <sup>3</sup> / <sub>4</sub> " (19mm) throw	
Fasteners & sex bolts (SNB)	Includes screw pack for 1 <sup>3</sup> / <sub>4</sub> " (44mm) and 2 <sup>1</sup> / <sub>4</sub> " (57mm) thick metal or wood doors. Optional 425 SNB available, see page 9 for quantities.	
Electric options	<b>LX</b>	Latchbolt monitor switch
	<b>RX</b>	Pushpad monitor switch
	<b>RX2</b>	Double pushpad monitor switch
	<b>E</b>	Electric locking & unlocking trim
	<b>EL</b>	Electric latch retraction
	<b>QEL</b>	Quiet electric latch retraction
	<b>SS</b>	Signal switch
	<b>CX</b>	Chexit delayed exit
	<b>ALK</b>	Alarm exit kit
	<b>WP-RX</b>	Waterproof request to exit
	<b>CON</b>	Allegion Connect
Mechanical options	<b>-2</b>	Double cylinder
	<b>AX</b>	Accessible device
	<b>GBK</b>	Glass bead kit
	<b>PN</b>	Pneumatic latch retraction
	<b>XP</b>	Extra protection
	<b>SNB</b>	Sex bolts
	<b>SEC</b>	Security screws
Dogging feature	Hex key dogging standard	
Dogging options	<b>CD</b>	Cylinder dogging
	<b>SD</b>	Special center case dogging
	<b>LD</b>	Less dogging
	<b>DI</b>	Dogging indicator
	<b>CI</b>	Cylinder dogging indicator
Strikes	<b>299</b> – Dull black	

**XP**  
**Extra protection**

- 90° latch-to-strike contact
- Force resistance of 2,000+ lbs.

**CD**  
**Cylinder dogging**

- Replaces hex key dogging
- Requires 1 1/4" mortise cylinder with inverted cam

**QEL**  
**Quiet electric latch retraction**

- Bolt retraction via switch
- Converts exit door to push-pull operation

**RX**  
**Pushpad monitor switch**

- Signals use of an opening
- SPDT switch to monitor pushpad

**CX**  
**Chexit delayed exit**

- Meets NFPA 101 requirements
- Self-contained controls, locking, alarm

**AX**  
**Accessible device**

- UL certified to meet new 5 lb. maximum operating force requirement
- Exceeds ANSI/BHMA requirements

**EL**  
**Electric latch retraction**

- Enables remote unlatching
- Alternative to manual dogging

**ALK**  
**Alarm exit kit**

- Unauthorized opening triggers 85-decibel horn
- Set in armed or disarmed mode by key

**PN**  
**Pneumatic latch retraction**

- For areas where electrical devices banned
- Special linkage for mechanical or pneumatic dogging

**CON**  
**Allegion Connectors**

- Common connectors to connect various door hardware all the way to the power supply

98/99 Rim exit device

# Nomenclature – how to order

		EL	99	27	-L	-16	-F	LBR	3'	US3	RHR
<b>None</b>	Standard										
<b>SD</b>	Special dogging R/VR - panic only										
<b>CD</b>	Cylinder dogging - panic only										
<b>CX</b>	Chexit										
<b>E</b>	Electric locking mortise/lever										
<b>QEL</b>	Quiet electric latch retraction										
<b>EL</b>	Electric latch retraction										
<b>LX</b>	Latch bolt monitoring										
<b>RX</b>	Request to exit										
<b>RX2</b>	Double request to exit										
<b>SS</b>	Signal switch										
<b>AX</b>	Accessible device										
<b>PL</b>	Pullman latch										
<b>PN</b>	Pneumatic latch retraction										
<b>WS</b>	Surface vertical rod exit device										
<b>XP</b>	Heavy protection - rim										
<b>WS</b>	Tornado & hurricane tested										
<b>98</b>	Series 98-smooth										
<b>99</b>	Series 99-grooved										
<b>None</b>	Rim device										
<b>27</b>	Surface mounted vertical rod device										
<b>47</b>	Concealed vertical rod device										
<b>47WDC</b>	Concealed vertical rod wood door device										
<b>48</b>	Concealed vertical rod device										
<b>49</b>	Concealed vertical cable device										
<b>49WDC</b>	Concealed vertical cable wood door device										
<b>57</b>	Three-point latch device										
<b>75</b>	Mortise lock device										
<b>AD</b>	AD Trim (to come from client)										
<b>DT</b>	Dummy trim										
<b>EO</b>	Exit only										
<b>HL</b>	Hospital pull trim										
<b>K</b>	Knob										
<b>K-BE</b>	Knob - blank escutcheon										
<b>K-DT</b>	Knob, rigid - dummy trim										
<b>K-NL</b>	Knob, rigid - night latch										
<b>L</b>	Lever (classroom)										
<b>L-BE</b>	Lever - blank escutcheon										
<b>L-DT</b>	Lever, rigid - dummy trim										
<b>L-NL</b>	Lever, rigid - night latch										
<b>NL</b>	Night latch										
<b>NL-OP</b>	Night latch cylinder assembly, optional pull										
<b>TL</b>	Turn lever										
<b>TL-BE</b>	Turn lever - blank escutcheon										
<b>TP</b>	Thumbpiece										
<b>TP-BE</b>	Thumbpiece - blank escutcheon										
<b>XX</b>	Lever style 06 standard Optional 01, 02, 03, 05, 07, 12 (Handed), 16 (Omega), 17, 18, Accent, Asti, Merano, St. Annes										
<b>F</b>	Fire exit device										
<b>-2</b>	Double cylinder (rim & mortise only)										
<b>LBR</b>	Less bottom rod										
<b>LBL</b>	Less bottom latch										
<b>SG</b>	Safety glow (luminescent) touchpad										
<b>ALK</b>	Alarm kit										
<b>CON</b>	Allegion Connect										
<b>2'</b>	2' Device (2' door size) 27, 47 or 49 only										
<b>3'</b>	3' Device (2' 4"- 3' door size)										
<b>4'</b>	4' Device (2' 10"- 4' door size)										
<b>Finishes</b>	US3, US4, US10, US26, US26D, US28, 313, 315 US32D – 98 ONLY -AM Antimicrobial (available US26D and US32D)										
<b>-LHR</b>	Left hand reverse										
<b>-RHR</b>	Right hand reverse										



# 98/99 RIM PANIC DEVICE

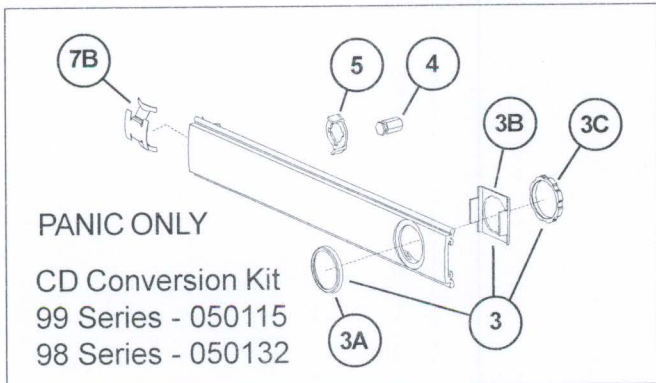
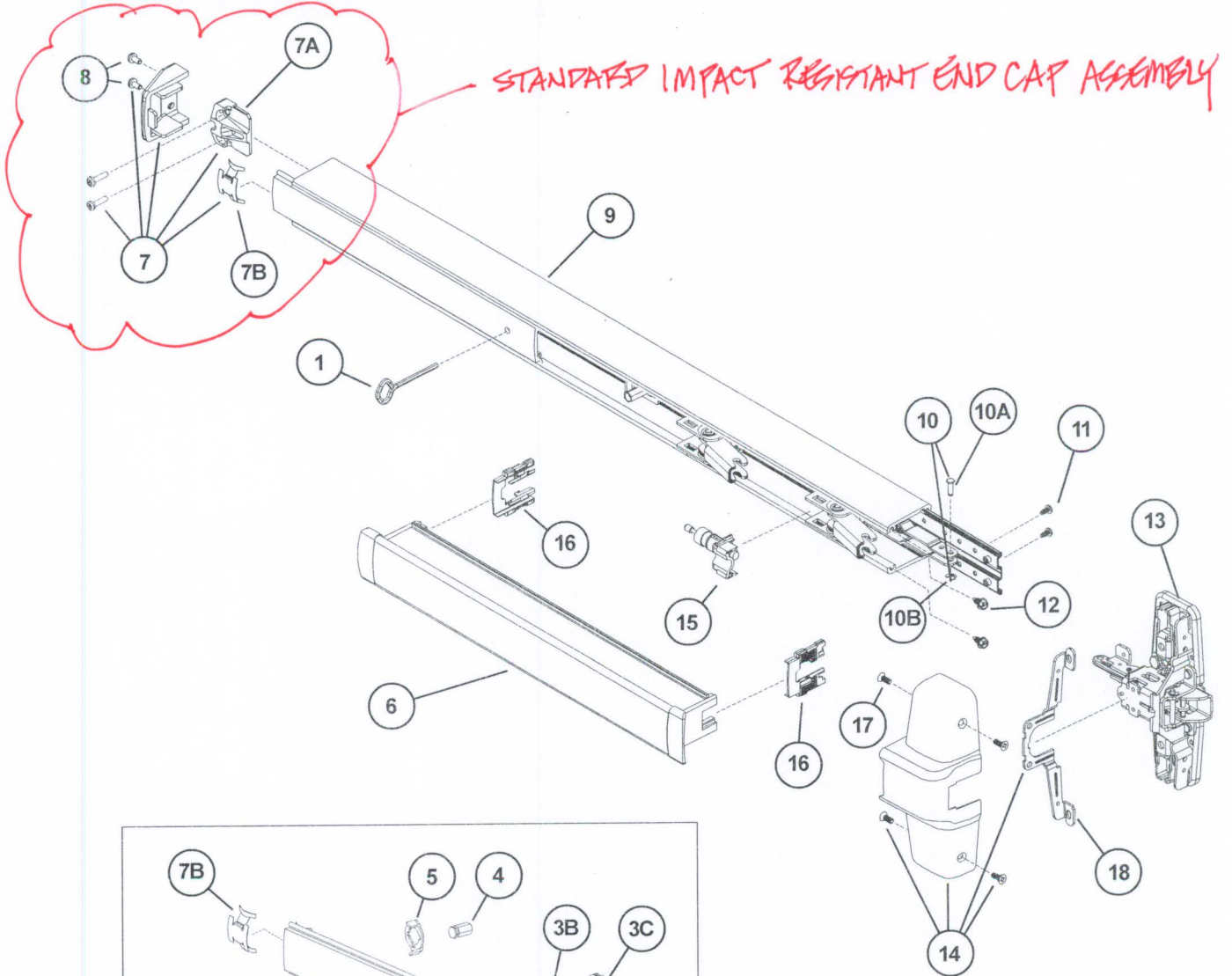

## 98/99 RIM PANIC DEVICE

Item No.	Quantity	Part No.	Description	Finish
	1	900561	98/99 Series Mounting Pkg. (1-3/4 & 2-1/4)	
1	1	090085	227 Dog Key 5/32" Hex (Pkg of 10)	
1	1	090005	227 Dog Key 5/32" Hex (Pkg of 2)	
2	1	090040	Hex Dog Shaft (Pkg of 2)	
3	1	107813	Cylinder Mounting Pkg	X
3A	1	050525	Cylinder Collar	X
3B	1	050490	Cylinder Locating Washer - CD/SS	
3C	1	050526	Cylinder Locknut	
4	1	090046	CD Dogging Plug (Pkg of 2)	
5	1	090045	CD Actuator Arm (Pkg of 2)	
6	1	*PBKIT	98/99 Series Push Bar Retrofit Kit - 3' Door	X
6	1	*PBKIT	98/99 Series Push Bar Retrofit Kit - 4' Door	X
7	1	050014	98/99 Series End Cap Kit	X
7A	1	050524	Impact Resistant End Cap Bracket	
7B	1	090036	Cover Plate Anti-rattle Spring (Pkg of 10)	
8	1	900597	Device End Cap and C/Case Screw Pkg.	X
9	1	968144	99 Series Mechanism Case - 3' Door	X
9	1	968146	99 Series Mechanism Case - 4' Door	X
9	1	970191	98 Series Mechanism Case - 3' Door	X
9	1	970192	98 Series Mechanism Case - 4' Door	X
10	1	050529	98/99 Series Control Link Pin & Ret. Ring	
10A	1	090031	98/99 Series Control Link Pin (Pkg of 10)	
10B	1	090107	Retaining Ring (Pkg of 10)	
11	2	090037	#8-32 x 3/8" Baseplate Screw (Pkg of 10)	
12	2	090073	Mechanism Case Bracket Screw (Pkg of 10)	
13***	1	050020	98/99 Rim Center Case Less Cover	
14**	1	050071	98/99 Rim Center Case Cover Kit	X
15	1	050491	Shock Absorber & Holder Assembly	
16	2	090049	Push Bar Guide (Pkg of 10)	
17	4	900892	Center Case Cover Screws (Pkg of 4)	X
18	1	050564	Center Case Cover Bracket	

X in "Finish" column designates finished items; finish must be specified when ordering.

\* To order, specify device type, size, and finish. Example: PBKIT 98 3' US28

\*\*Includes parts for three piece cover conversion

\*\*\*Center case assembly parts shown on page 9.



LCN®

Door  
controls





The 4040XP is LCN's most durable and flexible heavy duty closer designed for institutional and other demanding high traffic applications.

<b>Certifications</b>	Grade 1 - ANSI A156.4, UL 10C, ADA, 100 Hour Salt Spray, Meets BAA - Buy American Act	<b>Cover</b>	<ul style="list-style-type: none"> <li>Plastic, Standard</li> <li>Metal, Optional</li> </ul>
<b>Body Construction</b>	<ul style="list-style-type: none"> <li>Cast Iron Body</li> <li>Full Complement Bearings</li> <li>1-1/2" Diameter Piston</li> <li>3/4" Diameter Double Heat Treated Pinion Journal</li> </ul>	<b>Fasteners</b>	Self Reaming and Tapping Screws (SRT)
<b>Fluid</b>	All Weather Liquid X Fluid	<b>Mounting</b>	Hinge (Pull Side), Top Jamb (Push Side), Parallel Arm (Push Side)
<b>Handing</b>	Non-Handed	<b>Arms</b>	Regular Arm
<b>Templating</b>	Peel-n-Stick templates - 2-1/4" x 5" Mounting Hole Pattern	<b>Finishes/Colors/Powder Coat</b>	<ul style="list-style-type: none"> <li>Aluminum (689)</li> <li>Statuary Bronze (690)</li> <li>Light Bronze (691)</li> <li>Black (693)</li> <li>Dark Bronze (695)</li> <li>Brass (696)</li> <li>Custom colors optional</li> </ul>
<b>Size</b>	Adjustable Spring Size 1-6, includes Patented Green Dial		<ul style="list-style-type: none"> <li>Optional SRI primer - powder coat only</li> <li>Optional plated finishes</li> </ul>
<b>Warranty</b>	30 years		

**Special Templates**

Customized installation templates or products may be available to solve unusual applications. Contact LCN Product Support for assistance.

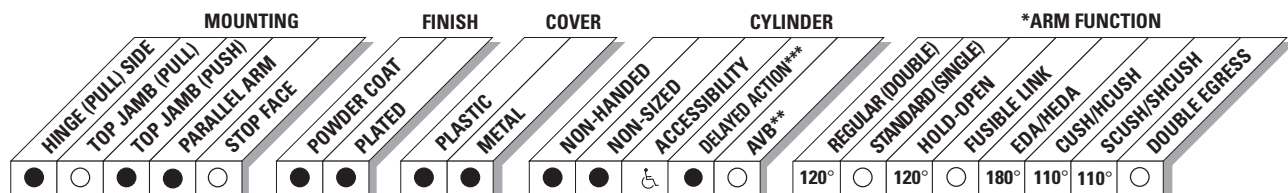

● AVAILABLE  
○ NOT AVAILABLE

♿ Closer available with less than 5.0 lbs. opening force on 36" door.  
 \* Maximum opening/hold-open point with standard template.  
 \*\* Advanced Variable Backcheck.  
 \*\*\* Delay feature incorporates standard 4040 cylinder (not XP).

### How-to-order 4040XP Series closers

#### 1. Select finish

- Standard Powder Coat \_\_\_\_\_  
Aluminum, Dark Bronze, Statuary,  
Light Bronze, Black, Brass.

#### Closer will be shipped with:

- Standard cylinder
- Standard cover
- Regular arm
- Self-reaming and tapping screws  
unless options listed below are selected.

### Closer options

#### Cylinder

- Delayed Action (4041 DEL)

#### Cover

- Metal (specify right or left hand) (MC)

#### Finish

- Custom Powder Coat (RAL) \_\_\_\_\_  
(handed metal cover required)
- Plated Finish, US \_\_\_\_\_  
(handed metal cover required)
- SRI primer (use with powder coat finishes only)

#### Arm

- Regular (REG)
- Regular w/62PA (Rw/PA)
- Regular w/62A (R/62A)
- Long (LONG)
- Extra Long (XLONG)
- Hold-Open (H)
- Hold-Open w/62PA (Hw/PA)
- Long Hold-Open (HLONG)
- Extra Duty Arm (EDA)
- Extra Duty Arm with 62G (EDA/62G)
- Hold Open Extra Duty Arm (HEDA)  
(Handed)
- Hold Open Extra Duty Arm with 62  
(HEDA/62G)(Handed)
- Cush-N-Stop (CUSH)
- HCush-N-Stop (HCUSH)
- Spring Cush (SCUSH)
- Spring HCush (SHCUSH)

#### Optional Screw Packs

- TB\* w/Self-Reaming and Tapping (TBSRT)
- Wood & Machine Screw (WMS)
- TB\*, Wood & Machine Screw (TBWMS)
- TORX Machine Screw (TORX)
- TB\* & TORX Machine Screw (TBTRX)  
\* Specify door thickness if other than  
1-3/4".

#### Installation Accessories

- Plate, 4040XP-18
- Plate, 4040XP-18TJ
- Plate, 4040XP-18G
- Plate, 4040XP-18PA
- CUSH Shoe Support, 4040XP-30
- Blade Stop Spacer, 4040XP-61
- Auxiliary Shoe, 4040XP-62A
- PA Flush Panel Adapter, 4040XP-419

#### Special Template

- ST- \_\_\_\_\_

### Table of sizes

- 4040XP cylinders are adjustable from size 1 through size 6 and is shipped set to size 3
- Closing power of 4040XP Series closers may be adjusted 50%

#### Exterior (and vestibule) door width



#### Interior door width

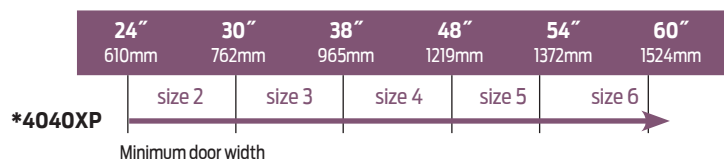

Indicates recommended range of door width for closer size. \*Adjustable Size 1 thru 6.

### Reduced opening force 4040XP Series closers

**CAUTION!** Any manual door closer, including those certified by BHMA to conform to ANSI Standard A156.4, that is selected, installed and adjusted based on ADA or other reduced opening force requirements may not provide sufficient power to reliably close and latch a door.

Refer to POWER OPERATORS section for information on systems that meet reduced opening force requirements without effecting closing power.

	DOOR WIDTH	36"	42"	48"
	8.5* lbs.	4040XP	4040XP	4040XP
5.0* lbs.	4040XP	4040XP	4040XP	

\* Maximum opening force.

**Arm Options**

- STD - Standard Arm
- REG - Regular Arm
- Rw/PA - Regular Arm with Parallel Arm Shoe
- R/62A - Regular Arm with Auxiliary Parallel Arm Shoe
- H - Hold Open Arm
- Hw/PA - Hold Open Arm with Parallel Arm Shoe
- LONG - Long Arm
- XLONG - Extra Long Arm
- HLONG - Hold Open Long Arm
- EDA - Extra Duty Arm
- EDAw/62G - Extra Duty Arm with Thick Hub Shoe
- HEDA - Hold Open Extra Duty Arm
- HEDAw/62G - Hold Open Extra Duty Arm w/ Thick Hub Shoe
- CUSH - Cush -n- Stop Arm
- HCUSH - Hold Open Cush -n- Stop Arm
- SCUSH(SCNS) - Spring Cush -n- Stop Arm
- SHCUSH(SHCNS) - Spring Hold Open Cush -n- Stop Arm
- SF - Swing Free Arm
- DE - Double Egress Arm
- FL - Fusible Link Arm

**Control Box Options**

- SC - Standard Control Box

**Cylinder Options**

- STD - Standard Cylinder
- DEL(DA) - Delayed Action Cylinder
- AVB - Advanced Variable Backcheck
- B80 - Bypass 80 Degree ME Cylinder
- B140 - Bypass 140 Degree ME Cylinder
- TEL - Telephone Cylinder

**Cover Option**

- STD - Standard Plastic Cover
- MC - Metal Cover
- FC - Full Cover
- CL - Cover Length
- DSI - Designer Series Cover

**Track Options**

- STD - Standard Track
- HO - Hold Open Track
- BUMPER - Track with Bumper
- HBUMPER - Hold Open Track with Bumper

**Fastener Pack Options**

- WMS - Wood & Machine Screws
- TBWMS - Thru-Bolt, Wood & Machine Screws
- SRT - Self Reaming & Tapping Screws
- TBSRT - Thru-Bolt, Self Reaming & Tapping Screws
- TORX - 'TORX' Machine Screws
- TBTRX - Thru-Bolt, 'TORX' Machine Screws
- UNIV - Universal Screw Pack

**Motor Gearbox Options**

- SF - Standard Force Motor Gearbox

**Powder Coat Finishes**

- AL - Aluminum
- DKBRZ - Dark Bronze
- STAT - Statuary Bronze
- LTBRZ - Light Bronze
- BLK - Black
- BRASS - Brass

**Miscellaneous Terms**

- ELR - Extra Long Rod
- SRI - Special Rust Inhibitor
- SE - Single Point Electronic
- ME - Multi-Point Electronic
- PAH - Parallel Arm Holder
- HSA - Hold Open / Scanner Activated
- ES - Electric Strike Relay (Control Boxes)
- S - Sequential (Control Boxes)
- RF - Radio Frequency
- TJ - Top Jamb
- PA - Parallel Arm
- G - Flush Ceiling
- T - Track
- DPS - Door Position Switch
- LR - Long Rod
- ST - Special Template
- RH - Right Hand
- LH - Left Hand
- HL - Header Length
- DD - Double Door Header
- POS - Positive Mechanical Stop
- BKY - Panic Breakaway Stop
- XP - Extra Protection



## Lever Extension Flush Bolt No. 555

**Material:** Brass

**Finishes:** Available in standard architectural finishes (see page 9)

**Fastener:** 8 ea. #8 x 3/4" FH combo screws

**Features:**

- For Fire Rated Hollow Metal Swinging Doors measuring up to 4'w x 10'h rated up to and including 3 Hours
- Fits ANSI A115 door and frame preparation
- 3/4" bolt throw, 3/4" rod backset
- 12" rod length (center of face to bolt end - retracted)
- 1 1/2" adjustable bolt head

**Options:**

- Other size rods available are 18", 24", 36", 48"
- Extra long bolt head - 2 1/2" (or to your specification)
- Use No. 570 Dust Proof Strike (shown on page E4) to prevent dirt blocking bottom strike

No.	Size	Weight	ANSI A156.16
555	Face plate: 1" x 6 3/4" Strike: 1 5/16" x 2 1/4" Guide: 1" x 2"	1.5 lbs./2	L04251



## Lever Extension Flush Bolt with Bottom Fire Bolt No. 555 x 18BFB

**Material:** Flush bolt – brass  
Bottom fire bolt – stainless steel

**Finishes:** Available in standard architectural finishes (see page 9)

**Fastener:** 8 ea. #8 x 3/4" FH combo screws

**Features:**

- For Fire Rated Hollow Metal Swinging Doors measuring up to 4'w x 9'h rated up to and including 3 Hours
- Fits ANSI A115 door and frame preparation
- 3/4" bolt throw, 3/4" rod backset
- 12" rod length (center of face to bolt end - retracted)
- 1 1/2" adjustable bolt head
- When door is subjected to 230°F the plug and black plastic cover will melt allowing the bolt to project, locking the leaves together
- Bottom fire bolt eliminates need for floor prep.
- Oversize fire bolt strike hole allows for slight door misalignment

**Options:**

- Other size rods available are 18", 24", 36", 48"
- Extra long bolt head – 2 1/2" (or to your specification)

No.	Size	Weight
555 x 18BFB	Top bolt: 1" x 6 3/4" Bottom bolt: 1 3/16" dia.	0.9 lbs.

**ASSA ABLOY**

The global leader in  
door opening solutions

800-458-2424 | [www.assaabloydooraccessories.us](http://www.assaabloydooraccessories.us)  
Check the web site for the up-to-date catalog

Copyright © 2012-2018, ASSA ABLOY Accessories and Door Controls Group, Inc. All rights reserved. Reproduction in whole or in part without the express written permission of ASSA ABLOY Accessories and Door Controls Group, Inc. is prohibited.



## Lever Extension Flush Bolt No. 556WS Windstorm

The Rockwood 556WS Flush Bolt is part of a UL certified assembly from ASSA ABLOY. Listed for use on both in-swing or out-swing paired applications, the full assembly includes doors from Ceco Door, Curries or Fleming and latching hardware from Corbin Ruswin, SARGENT or Yale.

- Material:** Brass and Stainless Steel
- Finishes:** 26D or 32D.
- Fastener:** 8 ea. #8 - 32 x 1/4" FH MS in Stainless Steel
- Features:**
- 3/4" bolt throw, 3/4" rod backset
  - 12" Stainless Steel rod length (center of face to bolt end - retracted).
  - UL Certified
  - Tested to ASTM E330, E1886, E1996 and the TAS 201, 202, and 203. Assembly approved for use in the state of Florida including the High Velocity Hurricane Zone (HVHZ)

No.	Size	Material	Weight	ANSI A156.16
556WS	Face plate: 1" x 6 <sup>3</sup> / <sub>4</sub> " x 1/8" Mortise Body 1" x 5 <sup>1</sup> / <sub>4</sub> " x 1 <sup>3</sup> / <sub>8</sub> " Rod 12" x 1/2"D Strike: 1 <sup>5</sup> / <sub>16</sub> " x 2 <sup>1</sup> / <sub>4</sub> " Guide: 1" x 2"	Brass Brass Stainless Steel Stainless Steel Stainless Steel	2.5 lbs./2	L04251



## Lever Extension Flush Bolt No. 557

- Material:** Cast brass
- Finishes:** Available in standard architectural finishes (see page 9)
- Fastener:**
- 7 ea. #8 x 3/4" FH combo screws
  - 4 ea. #8 - 32 x 1/2" FH MS
  - 4 ea. #8 counter sunk washer
- Features:**
- For Fire Rated Plastic & Wood Covered Doors measuring up to 4'w x 10'h rated up to and including 1 1/2 Hours
  - 3/4" bolt throw, 3/4" backset; door strength maintained by corner reinforcing plate
- Options:** Use No. 570 Dust Proof Strike (shown on page E4) to prevent dirt blocking bottom strike

No.	Size	Weight	ANSI A156.16
557	Face plate: 1" x 6 <sup>3</sup> / <sub>4</sub> " Strike: 1 <sup>5</sup> / <sub>16</sub> " x 2 <sup>1</sup> / <sub>4</sub> "	1.7 lbs./2	L04261

800-458-2424 | [www.assaabloydooraccessories.us](http://www.assaabloydooraccessories.us)  
Check the web site for the up-to-date catalog

Copyright © 2012-2018, ASSA ABLOY Accessories and Door Controls Group, Inc. All rights reserved. Reproduction in whole or in part without the express written permission of ASSA ABLOY Accessories and Door Controls Group, Inc. is prohibited.

**ASSA ABLOY**

The global leader in  
door opening solutions





## Automatic Flush Bolts No. 2840 (Automatic Top Bolt Only) No. 2842 (Set) (replaces the No. 1840 and No. 1842)

**Material:** Brass, stainless steel

**Finishes:** US3, US4, US10, US10BE, US26, US26D, US32D

**Fastener:** No. 2842: 20 ea. #8 x 3/4" FH combo screws, 2 ea. #6-8 plastic anchors  
No. 2840: 10 ea. #8 x 3/4" FH combo screws. NOTE: No plastic anchor required for top only

**Features:**

- For Fire Rated Metal Doors labeled A, B, C, D & E up to 4'w x 8'h
- Non-handed
- Fully automatic— opening active door retracts top and bottom bolts
- Override feature prevents damage to doors or bolts if bolt heads are blocked from entering strikes
- Bolt head rods are adjustable up to 1 1/2"
- Thermal lock automatically locks the inactive door under high heat conditions due to fire

**Options:** No. 2842 can be used with the No. 570 Dust Proof Strike (shown on page E4).

No.	Size	Weight	ANSI A156.3
2840	1" x 6 3/4"	1.2 lbs.	Type 25
2842	1" x 6 3/4"	2.4 lbs.	Type 25



## Combination Flush Bolts No. 2805 (Self Latching Top Bolt Only) No. 2845 (Set) (replaces No. 1805 and No. 1845)

**Material:** Brass, stainless steel

**Finishes:** US3, US4, US10, US10BE, US26, US26D, US32D

**Fastener:** Top: 8 ea. #8 x 3/4" FH combo screws. NOTE: No plastic anchor required for top only.  
Bottom (No. 2845 only) 18 ea. #8 x 3/4" FH combo screws, 2 ea. #6-8 plastic anchors.

**Features:**

- For Fire Rated Metal Doors labeled A, B, C, D & E up to 4'w x 8'h

**Top Bolt**

- Automatically engages when the inactive door closes. When the active door is opened, the inactive door stays latched at the top until the top bolt is released by pressing the plunger button on the bolt face

**Bottom Bolt (No. 2845 only)**

- Non-handed
- Fully automatic — opening active door retracts bottom bolt
- Override feature prevents damage to door or bolt if bolt head is blocked from entering strike
- Bolt head rod is adjustable up to 1 1/2"
- Thermal lock automatically locks the inactive door under high heat conditions due to fire

**Options:** No. 2845 can be used with the No. 570 Dust Proof Strike (shown on page E4)

No.	Size	Weight	ANSI A156.3
2805	1" x 6 3/4"	1.2 lbs.	Type 27
2845	1" x 6 3/4"	2.4 lbs.	Type 27

# ASSA ABLOY

The global leader in  
door opening solutions

800-458-2424 | [www.assaabloydooraccessories.us](http://www.assaabloydooraccessories.us)

Check the web site for the up-to-date catalog

Copyright © 2012-2018, ASSA ABLOY Accessories and Door Controls Group, Inc. All rights reserved. Reproduction in whole or in part without the express written permission of ASSA ABLOY Accessories and Door Controls Group, Inc. is prohibited.

## SECTION 08 8000

### GLAZING

#### PART 1 GENERAL

##### 1.01 SECTION INCLUDES

- A. Insulating glass units.
- B. Monolithic Glazing units.
- C. Glazing compounds and accessories.

##### 1.02 RELATED REQUIREMENTS

- A. Section 07 2500 - WEATHER BARRIERS.
- B. Section 08 1113 - Hollow Metal Doors and Frames: Glazed lites in doors and borrowed lites.
- C. Section 08 4313 - ALUMINUM ENTRANCES and STOREFRONTS: Glazing furnished as part of storefront assembly.
- D. Section 08 4413 - ALUMINUM CURTAIN WALL: Glazing furnished as part of wall assembly.
- E. Section 10 2800 - TOILET ACCESSORIES: Mirrors.

##### 1.03 REFERENCE STANDARDS

- A. 16 CFR 1201 - Safety Standard for Architectural Glazing Materials; current edition.
- B. ANSI Z97.1 - American National Standard for Safety Glazing Materials Used in Buildings, Safety Performance Specifications and Methods of Test; 2010.
- C. ASCE 7 - Minimum Design Loads for Buildings and Other Structures; 2010, with 2013 Supplements and Errata.
- D. ASTM C864 - Standard Specification for Dense Elastomeric Compression Seal Gaskets, Setting Blocks, and Spacers; 2005 (Reapproved 2011).
- E. ASTM C920 - Standard Specification for Elastomeric Joint Sealants; 2014.
- F. ASTM C1036 - Standard Specification for Flat Glass; 2011.
- G. ASTM C1048 - Standard Specification for Heat-Strengthened and Fully Tempered Flat Glass; 2012.
- H. ASTM C1172 - Standard Specification for Laminated Architectural Flat Glass; 2014.
- I. ASTM C1193 - Standard Guide for Use of Joint Sealants; 2013.
- J. ASTM C1376 - Standard Specification for Pyrolytic and Vacuum Deposition Coatings on Flat Glass; 2015.
- K. ASTM E1300 - Standard Practice for Determining Load Resistance of Glass in Buildings; 2012a.
- L. ASTM E2190 - Standard Specification for Insulating Glass Unit Performance and Evaluation; 2010.
- M. California Code of Regulations, Title 24, Part 11 California Green Building Standards Code, "CAL-Green".

- N. California Code of Regulations, Title 24, Part 2, California Building Code (CBC), International Building Code with California Amendments.
- O. GANA (GM) - GANA Glazing Manual; 2009.
- P. GANA (SM) - GANA Sealant Manual; 2008.
- Q. GANA (LGRM) - Laminated Glazing Reference Manual; 2009.
- R. IGMA TM-3000 - North American Glazing Guidelines for Sealed Insulating Glass Units for Commercial & Residential Use; 1990 (2004).
- S. ITS (DIR) - Directory of Listed Products; current edition.
- T. NFRC 100 - Procedure for Determining Fenestration Product U-factors; 2014.
- U. NFRC 200 - Procedure for Determining Fenestration Product Solar Heat Gain Coefficient and Visible Transmittance at Normal Incidence; 2014.
- V. NFRC 300 - Test Method for Determining the Solar Optical Properties of Glazing Materials and Systems; 2014.
- W. UL (DIR) - Online Certifications Directory; current listings at [database.ul.com](http://database.ul.com).

#### 1.04 DEFINITIONS

- A. Manufacturers of Glass Products: Firms that produce primary glass, fabricated glass, or both, as defined in referenced glazing publications.
- B. Glass Thicknesses: Indicated by thickness designations in millimeters according to ASTM C 1036.
- C. Interspace: Space between lites of an insulating-glass unit that contains dehydrated air or a specified gas.
- D. Deterioration of Coated Glass: Defects developed from normal use that are attributed to the manufacturing process and not to causes other than glass breakage and practices for maintaining and cleaning coated glass contrary to manufacturer's written instructions. Defects include peeling, cracking, and other indications of deterioration in metallic coating.
- E. Deterioration of Insulating Glass: Failure of hermetic seal under normal use that is attributed to the manufacturing process and not to causes other than glass breakage and practices for maintaining and cleaning insulating glass contrary to manufacturer's written instructions. Evidence of failure is the obstruction of vision by dust, moisture, or film on interior surfaces of glass.
- F. Deterioration of Laminated Glass: Defects developed from normal use that are attributed to the manufacturing process and not to causes other than glass breakage and practices for maintaining and cleaning laminated glass contrary to manufacturer's written instructions. Defects include edge separation, delamination materially obstructing vision through glass, and blemishes exceeding those allowed by referenced laminated-glass standard.
- G. Glazing Units Surfaces:
  - 1. Insulated units:
    - a. Side 1 - Exterior surface of outer pane.
    - b. Side 2 - Interior surface of outer pane.
    - c. Side 3 - Interior surface of inner pane.
    - d. Side 4 - Exterior surface of inner pane

2. Laminated units:
  - a. Side 1 - Top surface of top outer pane in horizontal orientation.
  - b. Interlayer: PVB material between two pieces of monolithic glass
  - c. Side 2 - Underside of bottom outer pane in horizontal orientation.

#### 1.05 SUBMITTALS

- A. See Section 01 3000 - Administrative Requirements, for submittal procedures.
- B. Product Data on Insulating Glass Unit and Glazing Unit Glazing Types: Provide structural, physical and environmental characteristics, size limitations, special handling and installation requirements.
- C. Product Data on Glazing Compounds and Accessories: Provide chemical, functional, and environmental characteristics, limitations, special application requirements, and identify available colors.
- D. Preconstruction Compatibility and Adhesion Test Report: Submit statement from sealant manufacturer indicating that glass and glazing materials have been tested for compatibility and adhesion with glazing sealants and interpreting test results relative to material performance, including recommendations for primers and substrate preparation needed to obtain adhesion.
- E. CAL-GREEN Submittals:
  1. Product Data - VOC Limits: For adhesives sealants, fillers and primers, documentation including printed statement of VOC contents, comply with limits specified in Section 01 6116.
- F. Samples: Submit two samples 12 by 12 inch (\_\_\_ by \_\_\_ mm) in size of glass units.
- G. Samples: Submit 2 inch (\_\_\_ mm) long bead of glazing sealant, color as selected.
- H. Certificate: Certify that products of this section meet or exceed specified requirements.
- I. Warranty Documentation: Submit manufacturer warranty and ensure that forms have been completed in Owner's name and registered with manufacturer.
- J. Maintenance Materials: Furnish the following for Owner's use in maintenance of project.
  1. See Section 01 6000 - Product Requirements, for additional provisions.
  2. Extra Insulating Glass Units: One of each glass size and each glass type.

#### 1.06 QUALITY ASSURANCE

- A. Perform Work in accordance with GANA (GM), GANA (SM), GANA (LGRM), IGMA TM-3000, and SIGMA TM-3000 for glazing installation methods. Maintain one copy on site.
- B. Manufacturer Qualifications: Company specializing in manufacturing the products specified in this section with minimum three years of documented experience.
- C. Installer Qualifications: An experienced installer who has completed glazing similar in material, design, and extent to that indicated for this Project; whose work has resulted in glass installations with a record of successful in-service performance; and who employs glass installers for this Project who are certified under the National Glass Association Glazier Certification Program as Level 2 (Senior Glaziers) or Level 3 (Master Glaziers).
- D. Glass Product Testing: Obtain glass test results for product test reports in "Submittals" Article from a qualified testing agency based on testing glass products.

1. Glass Testing Agency Qualifications: An independent testing agency with the experience and capability to conduct the testing indicated, as documented according to ASTM E 548.
- E. Elastomeric Glazing Sealant Product Testing: Obtain sealant test results for product test reports in "Submittals" Article from a qualified testing agency based on testing current sealant formulations within a 36-month period.
  1. Sealant Testing Agency Qualifications: An independent testing agency qualified according to ASTM C 1021 to conduct the testing indicated, as documented according to ASTM E 548.
  2. Test elastomeric glazing sealants for compliance with requirements specified by reference to ASTM C 920, and where applicable, to other standard test methods.
- F. Glazing for Fire-Rated Door Assemblies: Glazing for assemblies that comply with NFPA 80 and that are listed and labeled by a testing and inspecting agency acceptable to authorities having jurisdiction, for fire-protection ratings indicated, based on testing according to NFPA 252.
- G. Glazing for Fire-Rated Window Assemblies: Glazing for assemblies that comply with NFPA 80 and that are listed and labeled by a testing and inspecting agency acceptable to authorities having jurisdiction, for fire ratings indicated, based on testing according to NFPA 257.
- H. Safety Glazing Products: Comply with testing requirements in 16 CFR 1201 .
  1. Provide safety glazing products permanently marked with certification label of the Safety Glazing Certification Council (SGCC) <<http://www.sgcc.org/>> or another certification agency acceptable to authorities having jurisdiction.
  2. Where glazing units, including Kind FT glass and laminated glass, are specified in Part 2 articles for glazing lites, provide glazing products that comply with Category II materials only.
- I. Insulating-Glass Certification Program: Permanently marked either on spacers or on at least one component lite of units with appropriate certification label of the following testing and inspecting agency:
  1. Insulating Glass Certification Council.
  2. Associated Laboratories, Inc.
- J. Source Limitations for Glass: Provide materials produced by a single manufacturer or fabricator for each kind and condition of glass indicated and composed of primary glass obtained from a single source for each type and class required.
- K. Source Limitations for Glazing Accessories: Obtain glazing accessories through one source from a single manufacturer for each product and installation method indicated.

#### **1.07 MOCK-UPS**

- A. See Section 01 4000 - Quality Requirements, for additional mock-up requirements.
- B. Provide mock-up of storefront / curtain wall assembly including glass and air barrier and vapor retarder seal.
- C. Locate where directed.
- D. Mock-ups may remain as part of the Work.

#### **1.08 FIELD CONDITIONS**

- A. Do not install glazing when ambient temperature is less than 40 degrees F (4 degrees C).

- B. Maintain minimum ambient temperature before, during and 24 hours after installation of glazing compounds.

#### **1.09 WARRANTY**

- A. See Section 01 7000 - Closeout Submittals, for additional warranty requirements.
- B. Insulating Glass Units: Provide a ten (10) year manufacturer warranty to include coverage for seal failure, interpane dusting or misting, including providing products to replace failed units.
- C. Laminated Glass: Provide a ten (10) year manufacturer warranty to include coverage for delamination, including providing products to replace failed units.
- D. Manufacturer's Special Warranty for Coated-Glass Products: Manufacturer's standard form, made out to Owner and signed by coated-glass manufacturer agreeing to replace coated-glass units that deteriorate as defined in "Definitions" Article, f.o.b. the nearest shipping point to Project site, within specified warranty period indicated below.
  - 1. Warranty Period: Ten (10) years from date of Substantial Completion.

### **PART 2 PRODUCTS**

#### **2.01 MANUFACTURERS**

- A. Glass Fabricators:
  - 1. Any of the glass manufacturers named below.
  - 2. Viracon, Inc: [www.viracon.com/#sle](http://www.viracon.com/#sle).
  - 3. Substitutions: Refer to Section 01 6000 - Product Requirements.
- B. Float Glass Manufacturers:
  - 1. Guardian Glass, LLC: [www.guardianglass.com/#sle](http://www.guardianglass.com/#sle).
  - 2. Pilkington North America Inc: [www.pilkington.com/na/#sle](http://www.pilkington.com/na/#sle).
  - 3. Vitro Architectural Glass (formerly PPG Glass): [www.vitroglazings.com/#sle](http://www.vitroglazings.com/#sle).
  - 4. Substitutions: Refer to Section 01 6000 - Product Requirements.

#### **2.02 PERFORMANCE REQUIREMENTS - EXTERIOR GLAZING ASSEMBLIES**

- A. General: Provide glazing systems capable of withstanding normal thermal movement and wind and impact loads (where applicable) without failure, including loss or glass breakage attributable to the following: defective manufacture, fabrication, and installation; failure of sealants or gaskets to remain watertight and airtight; deterioration of glazing materials; or other defects in construction.
- B. VOC Limits for all adhesives sealants, fillers, primers and coatings: Comply with limits specified in Section 01 6116.
- C. Glass Design: Glass thickness designations indicated are minimums and are for detailing only. Confirm glass thicknesses by analyzing Project loads and in-service conditions. Provide glass lites in the thickness designations indicated for various size openings, but not less than thicknesses and in strengths (annealed or heat treated) required to meet or exceed the following criteria.
- D. Provide type and thickness of exterior glazing assemblies to support assembly dead loads, and to withstand live loads caused by positive and negative wind pressure acting normal to plane of glass.
  - 1. Specified Design Wind Loads: As indicated on structural drawings, but not less than wind loads applicable to Project as required by ASCE 7 "Minimum Design Loads for Buildings and Other Structures": Section 6.0 "Wind Loads."

2. Comply with ASTM E1300 for design load resistance of glass type, thickness, dimensions, and maximum lateral deflection of supported glass.
  3. Probability of Breakage for Vertical Glazing: 8 lites per 1000 for lites set vertically or not more than 15 degrees off vertical and under wind action.
    - a. Load Duration: 3 seconds.
  4. Seismic Loads: Design and size glazing components to withstand seismic loads and sway displacement in accordance with the requirements of ASCE 7.
  5. Provide glass edge support system sufficiently stiff to limit the lateral deflection of supported glass edges to less than 1/175 of their lengths under specified design load.
  6. Glass thicknesses listed are minimum.
- E. Vapor Retarder and Air Barrier Seals: Provide completed assemblies that maintain continuity of building enclosure vapor retarder and air barrier.
1. In conjunction with vapor retarder and joint sealer materials described in other sections.
    - a. Refer to Section 07 2500.
  2. To utilize the inner pane of multiple pane insulating glass units for the continuity of the vapor retarder and air barrier seal.
  3. To maintain a continuous vapor retarder and air barrier throughout the glazed assembly from glass pane to heel bead of glazing sealant.
- F. Thermal Movements: Provide glazing that allows for thermal movements resulting from the following maximum change (range) in ambient and surface temperatures acting on glass framing members and glazing components. Base engineering calculation on surface temperatures of materials due to both solar heat gain and nighttime-sky heat loss.
1. Temperature Change (Range): 120 deg F (67 deg C), ambient; 180 deg F (100 deg C), material surfaces.
- G. Thermal and Optical Performance: Provide exterior glazing products with performance properties as indicated. Performance properties are in accordance with manufacturer's published data as determined with the following procedures and/or test methods:
1. Center of Glass U-Value: Comply with NFRC 100 using Lawrence Berkeley National Laboratory (LBNL) WINDOW 6.3 computer program.
  2. Center of Glass Solar Heat Gain Coefficient (SHGC): Comply with NFRC 200 using Lawrence Berkeley National Laboratory (LBNL) WINDOW 6.3 computer program.
  3. Solar Optical Properties: Comply with NFRC 300 test method.
- H. Provide Kind FT (fully tempered) glass lites or laminated glass in all locations.

## 2.03 GLASS MATERIALS

- A. Float Glass: Provide float glass based glazing unless otherwise indicated.
1. Kind HS - Heat-Strengthened Type: Complies with ASTM C1048.
  2. Kind FT - Fully Tempered Type: Complies with ASTM C1048.
  3. Fully Tempered Safety Glass: Complies with ANSI Z97.1 or 16 CFR 1201 criteria for safety glazing used in hazardous locations.
  4. Patterned Glass Type: ASTM C1036, Type II - Patterned Flat Glass, Quality - Q5, Form 3 - Patterned glass, with color and performance characteristics as indicated.
  5. Thicknesses: As indicated; provide greater thickness as required for exterior glazing wind load design.
- B. Laminated Glass: Float glass laminated in accordance with ASTM C1172.
1. Laminated Safety Glass: Complies with ANSI Z97.1 - Class B or 16 CFR 1201 - Category I impact test requirements.
  2. Polyvinyl Butyral (PVB) Interlayer: 0.060 inch (1.524 mm) thick, minimum.

- C. Sputter-Coated Float Glass: ASTM C 1376, float glass with metallic-oxide or -nitride coating deposited by vacuum deposition process after manufacture and heat treatment (if any), and complying with other requirements specified.
1. Approved Manufacturers:
    - a. "Solarban 60 Solar Control Low-E Glass"; PPG Industries <<http://corporateportal.ppg.com>>(800-377-5267)
    - b. "Comfort Ti-AC-40"; AGC Flat Glass North America <<http://www.afgglass.com>> (800-251-0441)
    - c. "Sunguard SN-68"; Guardian Industries <<http://www.guardian.com>> (248-340-1800)
    - d. "Solarscreen 2000 - VE1-2M"; Viracon, Inc. <<http://www.viracon.com/index.php>> (800-533-2080)

## 2.04 INSULATING GLASS UNITS

- A. Manufacturers:
1. Any of the manufacturers specified for float glass.
  2. Fabricator certified by glass manufacturer for type of glass, coating, and treatment involved and capable of providing specified warranty.
  3. Guardian Glass, LLC: [www.guardianglass.com](http://www.guardianglass.com).
  4. Viracon, Apogee Enterprises, Inc: [www.viracon.com](http://www.viracon.com).
  5. Vitro Architectural Glass (formerly PPG Glass): [www.vitroglazings.com/#sle](http://www.vitroglazings.com/#sle).
  6. Substitutions: Refer to Section 01 6000 - Product Requirements.
- B. Insulating Glass Units: Types as indicated.
1. Durability: Certified by an independent testing agency to comply with ASTM E2190.
  2. Coated Glass: Comply with requirements of ASTM C1376 for pyrolytic (hard-coat) or magnetic sputter vapor deposition (soft-coat) type coatings on flat glass; coated vision glass, Kind CV; coated overhead glass, Kind CO; or coated spandrel glass, Kind CS.
  3. Metal Edge Spacers: Aluminum, bent and soldered corners.
  4. Spacer Color: Black.
  5. Edge Seal:
    - a. Dual-Sealed System: Provide polyisobutylene sealant as primary seal applied between spacer and glass panes, and silicone, polysulfide, or polyurethane sealant as secondary seal applied around perimeter.
  6. Color: Black.
  7. Purge interpane space with dry air, hermetically sealed.
- C. Type Clear - Sealed Insulating Glass Units: Vision glazing, low-E.
1. Application: All exterior glazing unless otherwise indicated.
  2. Substitutions: Refer to Section 01 6000 - Product Requirements.
    - a. Other products of the basis of design manufacturer and products of other manufacturers will be considered provided the overall performance is within the specified range(s) and the overall appearance is not significantly different from that of the specified product.
    - b. Architect's decision on substitutions is final.
  3. Between-lite space filled with air.
  4. Thermal Resistance (U-Value): 0.29, maximum.
  5. Total Solar Heat Gain Coefficient: 0.39, maximum.
  6. Total Visible Light Transmittance: 0.70 percent, minimum.
  7. Basis of Design: PPG Industries, Inc: [www.ppgideascape.com](http://www.ppgideascape.com).
  8. Outboard Lite: Fully tempered float glass, 1/4 inch (6 mm) thick, minimum.



- a. Coating: PPG Solarban 60 on # 2 surface, no coating on #3 surface.
  - b. Tint: None (clear).
  9. Inboard Lite: Fully tempered float glass, 1/4 inch (6 mm) thick.
    - a. Tint: None (clear).
  10. Total Thickness: 1 inch (25 mm).
- D. Type Blue Tinted - Sealed Insulating Glass Units: Vision glazing, low-E.
1. Substitutions: Refer to Section 01 6000 - Product Requirements.
    - a. Other products of the basis of design manufacturer and products of other manufacturers will be considered provided the overall performance is within the specified range(s) and the overall appearance is not significantly different from that of the specified product.
    - b. Architect's decision on substitutions is final.
  2. Between-lite space filled with air.
  3. Thermal Resistance (U-Value): 0.29, maximum.
  4. Total Solar Heat Gain Coefficient: 0.28, maximum.
  5. Total Visible Light Transmittance: 0.54 percent, minimum.
  6. Basis of Design: PPG Industries, Inc: [www.ppgideascape.com](http://www.ppgideascape.com).
  7. Outboard Lite: Fully tempered float glass, 1/4 inch (6 mm) thick, minimum.
    - a. Coating: PPG Solarban 60 on # 2 surface, no coating on #3 surface.
    - b. Tint: Azuria (light blue).
  8. Inboard Lite: Fully tempered float glass, 1/4 inch (6 mm) thick.
    - a. Tint: None (clear).
  9. Total Thickness: 1 inch (25 mm).
- E. Type Gray Tinted - Sealed Insulating Glass Units: Vision glazing, low-E.
1. Application: All exterior glazing unless otherwise indicated.
  2. Substitutions: Refer to Section 01 6000 - Product Requirements.
    - a. Other products of the basis of design manufacturer and products of other manufacturers will be considered provided the overall performance is within the specified range(s) and the overall appearance is not significantly different from that of the specified product.
    - b. Architect's decision on substitutions is final.
  3. Between-lite space filled with air.
  4. Thermal Resistance (U-Value): 0.32, maximum.
  5. Total Solar Heat Gain Coefficient: 0.12, maximum.
  6. Total Visible Light Transmittance: 0.34 percent, minimum.
  7. Basis of Design: PPG Industries, Inc: [www.ppgideascape.com](http://www.ppgideascape.com).
  8. Outboard Lite: Fully tempered float glass, 1/4 inch (6 mm) thick, minimum.
    - a. Coating: PPG Solarcool on #2 surface and Sungate 400 on #3 surface.
    - b. Tint: Graylite.
  9. Inboard Lite: Fully tempered float glass, 1/4 inch (6 mm) thick.
    - a. Tint: None (clear).
  10. Total Thickness: 1 inch (25 mm).

## 2.05 GLAZING UNITS

- A. Type G-2 - Monolithic Interior Vision Glazing:
1. Applications: Interior glazing unless otherwise indicated.
  2. Glass Type: Fully tempered float glass.
  3. Tint: Clear.
  4. Thickness: 1/4 inch (6.4 mm), nominal.

- B. Type G-3 - Fire-Resistance-Rated Glazing: Type, thickness, and configuration of glazing that contains flame, smoke, and blocks radiant heat, as required to achieve indicated fire-rating period exceeding 45 minutes.
  - 1. Applications:
  - 2. Provide products listed by ITS (DIR) or UL (DIR) and approved by authorities having jurisdiction.
  - 3. Safety Glazing Certification: 16 CFR 1201 Category II.
  - 4. Fire-Rating Period: 60 minutes.
- C. Type G-15 - Satin-Etched Glazing: Etched glass patterns as full-coverage or as discrete designs, applied to single side or to both sides.
  - 1. Applications: Locations as indicated on drawings.
  - 2. Tint: Clear.
  - 3. Glass Type: Annealed; monolithic glass system.

## 2.06 GLAZING COMPOUNDS

- A. Butyl Sealant: Single component; ASTM C920, Grade NS, Class 12-1/2, Uses M and A, Shore A hardness of 10 to 20; black color.
- B. Silicone Sealant: Single component; neutral curing; capable of water immersion without loss of properties; non-bleeding, non-staining; ASTM C920, Type S, Grade NS, Class 25, Uses M, A, and G; with cured Shore A hardness range of 15 to 25; black color.

## 2.07 ACCESSORIES

- A. Setting Blocks: Silicone, with 80 to 90 Shore A durometer hardness; ASTM C864 Option II. Length of 0.1 inch for each square foot (25 mm for each square meter) of glazing or minimum 4 inch (100 mm) by width of glazing rabbet space minus 1/16 inch (1.5 mm) by height to suit glazing method and pane weight and area.
- B. Spacer Shims: Neoprene, 50 to 60 Shore A durometer hardness; ASTM C864 Option II. Continuous by one half the height of the glazing stop by thickness to suit application, self adhesive on one face.
- C. Glazing Tape, Back Bedding Mastic Type: Preformed, butyl-based, 100 percent solids compound with integral resilient spacer rod applicable to application indicated; 5 to 30 cured Shore A durometer hardness; coiled on release paper; black color.
  - 1. Width: As required for application.
  - 2. Thickness: As required for application.
  - 3. Spacer Rod Diameter: As required for application.
  - 4. Manufacturers:
    - a. Pecora Corporation; \_\_\_\_: [www.pecora.com/#sle](http://www.pecora.com/#sle).
    - b. Substitutions: Refer to Section 01 6000 - Product Requirements.
- D. Glazing Splines: Resilient silicone extruded shape to suit glazing channel retaining slot; ASTM C864 Option II; color black.

## 2.08 SOURCE QUALITY CONTROL

- A. Provide shop inspection and testing for insulated glass.

### **PART 3 EXECUTION**

#### **3.01 VERIFICATION OF CONDITIONS**

- A. Verify that openings for glazing are correctly sized and within tolerances, including those for size, squareness, and offsets at corners.
- B. Verify that the minimum required face and edge clearances are being provided.
- C. Verify that surfaces of glazing channels or recesses are clean, free of obstructions that may impede moisture movement, weeps are clear, and support framing is ready to receive glazing system.
- D. Verify that sealing between joints of glass framing members has been completed effectively.
- E. Glass Product:
  - 1. Verify that each piece of glass is free of scratches or marred surfaces.
  - 2. Verify that all edges are clean cut and finished in the specified manner.
- F. Obtain installers written report listing conditions detrimental to performance of glazing work. Proceed with glazing system installation only after unsatisfactory conditions have been corrected.

#### **3.02 PREPARATION**

- A. Clean contact surfaces with appropriate solvent and wipe dry within maximum of 24 hours before glazing. Remove coatings that are not tightly bonded to substrates.
- B. Seal porous glazing channels or recesses with substrate compatible primer or sealer.
- C. Prime surfaces scheduled to receive sealant where required for proper sealant adhesion.

#### **3.03 INSTALLATION, GENERAL**

- A. Install glazing in compliance with written instructions of glass, gaskets, and other glazing material manufacturers, unless more stringent requirements are indicated, including those in glazing referenced standards.
- B. Install glazing sealants in accordance with ASTM C1193, GANA (SM), and manufacturer's instructions.
- C. Do not exceed edge pressures around perimeter of glass lites as stipulated by glass manufacturer.
- D. Protect glass from edge damage during handling and installation. Inspect glass during installation and discard pieces with edge damage that could affect glass performance.
  - 1. Use a rolling block in rotating glass units to prevent damage to glass corners.
  - 2. Do not impact glass with metal framing.
  - 3. Use suction cups to shift glass units within openings; do not raise or drift glass with a pry bar.
  - 4. Rotate glass with flares or bevels along one horizontal edge which would occur in vicinity of setting blocks so that these are located at top of opening.
  - 5. Discard glass units with edge damage or other imperfections of kind that, when installed, weakens glass and impairs performance and appearance.
- E. Provide spacers for glass lites where length plus width is larger than 50 -inches (1270 mm) as follows:
  - 1. Locate spacers directly opposite each other on both inside and outside faces of glass. Install correct size and spacing to preserve required face clearances, unless gaskets and

glazing tapes are used that have demonstrated ability to maintain required face clearances and to comply with system performance requirements.

2. Provide 1/8-inch (3-mm) minimum bite of spacers on glass and use thickness equal to sealant width. With glazing tape, use thickness slightly less than final compressed thickness of tape.
- F. Set glass lites of system with uniform pattern, draw, bow, and similar characteristics.
- G. Set glass lites in proper orientation so that coatings face exterior or interior as indicated.
- H. Provide edge blocking where indicated or needed to prevent glass lites from moving sideways in glazing channel, as recommended in writing by glass manufacturer and according to requirements in referenced glazing publications.
- I. Install so that appropriate rating agency markings remain permanently visible.
- J. Prevent glass from contact with any contaminating substances that may be the result of construction operations such as, and not limited to the following: weld splatter, fire-safing, plastering, mortar droppings, etc.

#### **3.04 INSTALLATION - WET/DRY GLAZING METHOD (PREFORMED TAPE AND SEALANT)**

- A. Application - Exterior Glazed: Set glazing infills from the exterior of the building.
- B. Cut glazing tape to length and set against permanent stops, 3/16 inch (5 mm) below sight line. Seal corners by butting tape and dabbing with butyl sealant.
- C. Apply heel bead of butyl sealant along intersection of permanent stop with frame ensuring full perimeter seal between glass and frame to complete the continuity of the air and vapor seal.
- D. Place setting blocks at 1/4 points with edge block no more than 6 inch (152 mm) from corners.
- E. Rest glazing on setting blocks and push against tape and heel bead of sealant with sufficient pressure to attain full contact at perimeter of pane or glass unit.
- F. Install removable stops, with spacer strips inserted between glazing and applied stops 1/4 inch (6.4 mm) below sight lines.
  1. Place glazing tape on glazing pane of unit with tape flush with sight line.
- G. Fill gap between glazing and stop with silicone type sealant to depth equal to bite of frame on glazing, but not more than 3/8 inch (9 mm) below sight line.
- H. Apply cap bead of silicone type sealant along void between the stop and the glazing, to uniform line, flush with sight line. Tool or wipe sealant surface smooth.

#### **3.05 INSTALLATION - WET/DRY GLAZING METHOD (TAPE AND SEALANT)**

- A. Application - Interior Glazed: Set glazing infills from the interior of the building.
- B. Cut glazing tape to length and install against permanent stops, projecting 1/16 inch (1.6 mm) above sight line.
- C. Place setting blocks at 1/4 points with edge block no more than 6 inch (152 mm) from corners.
- D. Rest glazing on setting blocks and push against tape to ensure full contact at perimeter of pane or unit.

- E. Install removable stops, spacer shims inserted between glazing and applied stops at 24 inch (610 mm) intervals, 1/4 inch (6 mm) below sight line.
- F. Fill gaps between pane and applied stop with silicone type sealant to depth equal to bite on glazing, to uniform and level line.
- G. Carefully trim protruding tape with knife.

### **3.06 TOLERANCES**

- A. Erection Tolerances: Install components plumb, level, accurately aligned, and located in reference to column lines and floor levels. Erection tolerances indicated below are the maximum allowable for both no-load and full-load conditions and are not cumulative. Adjust work to conform to the following tolerances:
  - 1. Plumb: 1/8 -inch in 10 -feet; 1/4 -inch in 40 -feet.
  - 2. Level: 1/8 -inch in 20 -feet; 1/4 -inch in 40 -feet.
  - 3. Alignment: Limit offset of member alignment to 1/16 -inch where surfaces are flush or less than 1/2 -inch out of flush and separated by less than 3 -inches by protruding work; otherwise limit offsets to 1/8 inch.

### **3.07 FIELD QUALITY CONTROL**

- A. Glass and Glazing product manufacturers to provide field surveillance of the installation of their products.
- B. Monitor and report installation procedures and unacceptable conditions.

### **3.08 CLEANING**

- A. Remove excess glazing materials from finish surfaces immediately after application using solvents or cleaners recommended by manufacturers.
- B. Remove non-permanent labels immediately after glazing installation is complete.
- C. Clean glass and adjacent surfaces after sealants are fully cured.
- D. Clean glass on both exposed surfaces not more than 4 days prior to Date of Substantial Completion in accordance with glass manufacturer's written recommendations.

### **3.09 PROTECTION**

- A. After installation, mark pane with an 'X' by using removable plastic tape or paste; do not mark heat absorbing or reflective glass units.
- B. Examine glass surfaces adjacent to or below exterior concrete and other masonry surfaces at frequent intervals during construction, but not less often than once a month, for build-up of dirt, scum, alkali deposits or staining. When examination reveals presence of these forms of residue, remove by method recommended by glass manufacturer.
- C. Remove and replace glass that is damaged during construction period prior to Date of Substantial Completion.

**END OF SECTION**

## SECTION 08 9100

### LOUVERS

#### PART 1 GENERAL

##### 1.01 SECTION INCLUDES

- A. Section specifies shop fabricated and manufactured metal louvers and vents which are not an integral part of the mechanical system. Metal mesh screens are also specified.

##### 1.02 RELATED REQUIREMENTS

- A. Section 07 2500 - WEATHER BARRIERS: Sealing frames to weather barrier installed on adjacent construction.
- B. Section 07 9200 - Joint Sealants: Sealing joints between frames and adjacent construction.
- C. Section \_\_\_\_\_: Door louvers.
- D. Pertinent sections of Division 15 specifying ductwork, mechanical registers, and mechanical systems connecting to louvers.

##### 1.03 REFERENCE STANDARDS

- A. AAMA 611 - Voluntary Specification for Anodized Architectural Aluminum; 2012.
- B. AAMA 2604 - Voluntary Specification, Performance Requirements and Test Procedures for High Performance Organic Coatings on Aluminum Extrusions and Panels; 2013.
- C. AAMA 2605 - Voluntary Specification, Performance Requirements and Test Procedures for Superior Performing Organic Coatings on Aluminum Extrusions and Panels; 2013.
- D. AMCA 500-L - Laboratory Methods of Testing Louvers for Rating; 2012.
- E. AMCA 511 - Certified Ratings Program for Air Control Devices; 2010.
- F. ASTM A666 - Standard Specification for Annealed or Cold-Worked Austenitic Stainless Steel Sheet, Strip, Plate, and Flat Bar; 2015.
- G. ASTM B209 - Standard Specification for Aluminum and Aluminum-Alloy Sheet and Plate; 2014.
- H. ASTM B221 - Standard Specification for Aluminum and Aluminum-Alloy Extruded Bars, Rods, Wire, Profiles, and Tubes; 2014.

##### 1.04 SUBMITTALS

- A. See Section 01 3300 - Submittals for submittal procedures.
- B. Product Data: Provide data describing design characteristics, maximum recommended air velocity, design free area, materials and finishes.
- C. Shop Drawings: Indicate louver layout plan and elevations, opening and clearance dimensions, tolerances; head, jamb and sill details; blade configuration, screens, blackout areas required, and frames.
- D. Samples: Submit two samples 2 by 2 inches (50 by 50 mm) in size illustrating finish and color of exterior and interior surfaces.
- E. Test Reports: Independent agency reports showing compliance with specified performance criteria.

- F. Manufacturer's Certificate: Certify that products meet or exceed specified requirements.

#### 1.05 QUALITY ASSURANCE

- A. Manufacturer Qualifications: Company specializing in manufacturing products of the type specified in this section, with minimum three years of documented experience.

#### 1.06 PROJECT CONDITIONS

- A. Coordinate work of this section with installation of mechanical ductwork .

#### 1.07 WARRANTY

- A. See Section 01 7000 - Contract Closeout, for additional warranty requirements.
- B. Provide five year manufacturer's warranty against distortion, metal degradation, and connection failures of louver components.
1. Finish: Include twenty year coverage against degradation of exterior finish.

### PART 2 PRODUCTS

#### 2.01 MANUFACTURERS

- A. Airolite Company, LLC: [www.airolite.com/#sle](http://www.airolite.com/#sle).
- B. American Warming and Ventilating: [www.awv.com/#sle](http://www.awv.com/#sle).
- C. Construction Specialties, Inc: [www.c-sgroup.com/#sle](http://www.c-sgroup.com/#sle).
- D. Ruskin Company: [www.ruskin.com/#sle](http://www.ruskin.com/#sle).
- E. Substitutions: See Section 01 6000 - Product Requirements.

#### 2.02 LOUVERS

- A. Louvers: Factory fabricated and assembled, complete with frame, mullions, and accessories; AMCA Certified in accordance with AMCA 511.
1. Wind Load Resistance: Design to resist positive and negative wind load of 25 psf (1.2 kPa) without damage or permanent deformation.
  2. Intake Louvers: Design to allow maximum of 0.01 oz/sq ft (3.1 g/sq m) water penetration at calculated intake design velocity based on design air flow and actual free area, when tested in accordance with AMCA 500-L.
  3. Drainable Blades: Continuous rain stop at front or rear of blade aligned with vertical gutter recessed into both jambs of frame.
- B. Stationary Louvers: Horizontal blade, extruded aluminum construction, with intermediate mullions matching frame.
1. Free Area: 50 percent, minimum.
  2. Static Pressure Loss: As required for proper operation of mechanical systems as designed. Provide test data confirming appropriate values in inches wg maximum per square foot of free area at indicated velocity(ies) in fpm, when tested in accordance with AMCA 500-L.
  3. Blades: Drainable.
  4. Frame: 4 inches (100 mm) deep, channel profile; corner joints mitered and provided with sill pan and flashing flanges at head and jamb..
  5. Aluminum Thickness: Frame 12 gage, 0.0808 inch (2.05 mm) minimum; blades 12 gage, 0.0808 inch (2.05 mm) minimum.

### **2.03 MATERIALS**

- A. Extruded Aluminum: ASTM B221 (ASTM B221M).

### **2.04 FINISHES**

- A. Superior Performing Organic Coatings System: Polyvinylidene fluoride (PVDF) multi-coat superior performing organic coatings system complying with AAMA 2605, including at least 70 percent PVDF resin, and at least 80 percent of aluminum extrusion and panels surfaces having minimum total dry film thickness (DFT) of 1.2 mils, 0.0012 inch (0.030 mm).
  - 1. Manufacturers:
    - a. PPG Metal Coatings; Duranar: [www.ppgmetalcoatings.com/#sle](http://www.ppgmetalcoatings.com/#sle).
    - b. Sherwin-Williams Company; SHER-NAR 5000: [oem.sherwin-williams.com/#sle](http://oem.sherwin-williams.com/#sle).
    - c. Valspar; Fluropon: [www.valsparcoilextrusion.com/#sle](http://www.valsparcoilextrusion.com/#sle).
    - d. Substitutions: See Section 01 6000 - Product Requirements.
- B. Color(s) as selected by Architect from:
  - 1. Manufacturer's full range of available colors, including premium Pearlescent Metallic selections, minimum 18 premium selections.
- C. Touch-Up Materials: As recommended by coating manufacturer for field application.

### **2.05 ACCESSORIES**

- A. Blank-Off Panels: Same material as louver, painted black on exterior side; provide where duct connected to louver is smaller than louver frame, sealing off louver area outside duct.
- B. Insect Screen: 18 x 16 size aluminum mesh.
- C. Fasteners and Anchors: Stainless steel.
- D. Flashings: Of same material as louver frame, formed to required shape, single length in one piece per location.
- E. Sealant for Setting Sills and Sill Flashing: Non-curing butyl type.

## **PART 3 EXECUTION**

### **3.01 EXAMINATION**

- A. Verify that prepared openings and flashings are ready to receive this work and opening dimensions are as indicated on shop drawings.
- B. Verify that field measurements are as indicated.

### **3.02 INSTALLATION**

- A. Install louver assembly in accordance with manufacturer's instructions.
- B. Install louvers level and plumb.
- C. Set sill members and sill flashing in continuous bead of sealant.
- D. Install flashings and align louver assembly to ensure moisture shed from flashings and diversion of moisture to exterior.
- E. Integrate Air-Weather Barrier of wall assembly with louver flashing flanges.
- F. Secure louver frames in openings with concealed fasteners.



**3.03 CLEANING**

- A. Strip protective finish coverings.
- B. Clean surfaces and components.
- C. Touch-up surfaces damaged after installation so that no unfinished substrate is visible in completed assemblies, including joint edges.

**END OF SECTION**

**SECTION 09 0511**  
**CONCRETE FLOOR PREPARATION**

**PART 1 GENERAL**

**1.01 SUMMARY**

- A. Mechanical cleaning of new concrete floor surfaces for application of finished flooring.

**1.02 RELATED REQUIREMENTS**

- A. Section 01 8113 - Sustainable Design Requirements.
- B. Division 03 Section - Cast-In-Place Concrete for concrete floor slabs.
- C. Division 07 Section - Water Vapor Emission Control System.
- D. Division 09 Sections for applied floor finishes.

**1.03 REFERENCES**

- A. ASTM C1583 - Standard Test Method for Tensile Strength of Concrete Surfaces and the Bond Strength or Tensile Strength of Concrete Repair and Overlay Materials by Direct Tension (Pull-off Method).
- B. ASTM D4258 - Standard Practice for Surface Cleaning Concrete for Coating.
- C. ASTM D4259 - Standard Practice for Abrading Concrete.
- D. California Code of Regulations, Title 24, Part 11 California Green Building Standards Code, "CAL-Green".
- E. California Code of Regulations, Title 24, Part 2, California Building Code (CBC), International Building Code.
- F. International Concrete Repair Institute (ICRI) Guideline No. 03732- Selecting and Specifying Concrete; Surface Preparation for Sealers, Coatings and Polymer Overlays.

**1.04 ADMINISTRATIVE REQUIREMENTS**

- A. Preinstallation Conference: Conduct conference at Project site to comply with requirements in Division 1 Section "Project Management and Coordination."
  - 1. Review conditions affecting substrate preparation.
  - 2. Review procedures that will be used for substrate preparation.
  - 3. Require attendance by Water Vapor Emission Control and Finish Flooring installers to review preparation requirements of floor finish product and flooring adhesive manufacturers

**1.05 SUBMITTALS**

- A. Product Data: For each type of mechanical cleaning equipment used on the project.
- B. CAL-Green Submittals:
  - 1. Dust Control Plan: Written description of materials and procedures used to control and remove dust from working area, prevent contamination of HVAC systems.
- C. Informational Submittals
  - 1. Qualification Data: For Installer performing surface preparation.
  - 2. Field quality-control reports.
    - a. Submit report of observations.

- b. Certify installation is complete in accordance with acceptance criteria specified.
- c. Indicate supplementary instructions provided for Project specific conditions.

#### **1.06 QUALITY ASSURANCE**

- A. **Installer Qualifications:** An entity that employs installers and supervisors who are trained in the use of the equipment and techniques required to produce the specified results.
- B. **Mockups:** Provide field mockups to set quality standards for surface preparation execution and for preconstruction testing.
  - 1. Provide mockup of typical surface preparation, minimum 100 sq. ft. area. Coordinate required size with requirements for preconstruction testing.
  - 2. Approval of mockups does not constitute approval of deviations from the Contract Documents contained in mockups unless Architect specifically approves such deviations in writing.
  - 3. Subject to compliance with requirements, approved mockups may become part of the completed Work..

#### **PART 2 PRODUCTS - NOT USED**

#### **PART 3 EXECUTION**

##### **3.01 EXAMINATION**

- A. Verify new concrete floors have cured minimum 28 days.
- B. Examine substrates, with Installer (s) present, for compliance with requirements for surface contamination, damage, and other conditions affecting performance of the Work.
- C. Examine substrate to determine repairs required to restore substrate surface to be within tolerances required for floor finishes specified in other sections, prior to completing Work of this section.
- D. Examine substrate to verify surfaces prepared in accordance with this section will be suitable for application of finishes specified in other sections.
- E. Prepare written report, endorsed by Installer, listing conditions detrimental to performance with recommendations for methods and materials required to correct conditions before proceeding with work of this section.
- F. Proceed with surface preparation only after unsatisfactory conditions have been corrected.
  - 1. Proceeding with surface preparations indicates acceptance and of surfaces and conditions of substrate.

##### **3.02 SURFACE PREPARATION EQUIPMENT**

- A. **Mechanical Cleaning Equipment:** Automatic, dry shot blast type, self contained capable of recycling blast materials and collecting surface abrasions.

##### **3.03 SURFACE PREPARATION**

- A. **Protection:** Mask and protect walls, equipment from adjacent work and finishes during installation process.
- B. **Mechanically clean concrete substrate and create surface profile in existing concrete substrate in accordance with ASTM D 4259 as required to meet acceptance criteria specified.**
  - 1. Acceptable methods include shotblasting, scarifying or grinding. Grinding is only acceptable in locations unreachable by shotblast or scarification equipment.
- C. **Acceptance Criteria:**

1. Surface profile of ICRI CSP 3 minimum, and greater as required by coating manufacturer in related sections, all in accordance with ICRI Technical Bulletin No. 03732.
  2. Tensile Strength of Concrete Surface: 200 psi minimum according to ASTM C1583 Test Method.
  3. Free of laitance, oil, grease, flooring adhesive, paint, and other surface contaminants capable of affecting bond of specified floor coatings and finishes to concrete substrate.
- D. If floor develops areas of surface roughness greater than ICRI CSP-4 during preparation, apply patching/leveling compound in those areas and re-abrade to produce specified profile.
- E. Repair surface irregularities after cleaning.
1. Fill bugholes, spalls, cracks, deteriorated joints and other surface damage exposed or created as a result of substrate cleaning operations flush with adjacent surfaces to provide sound substrate for specified floor finish.
- F. Dry broom or vacuum clean concrete substrates immediately before application of specified floor finishes in accordance with ASTM D 4258 to remove loose materials on substrate surface.
- G. When field quality control report indicates portions are unsatisfactory, repeat process until field quality control report indicates there are no unsatisfactory portions remaining.
1. Areas of insufficient strength shall be ground to remove weak materials and abrasively prepared again using appropriately modified methods. Retest these areas for tensile strength until compliance is determined.

#### **3.04 FIELD QUALITY CONTROL**

- A. Testing Agency: Owner will engage a qualified testing and inspecting agency to perform the following field tests and inspections and prepare test reports:
1. Visual inspection of completed substrate preparation to verify contamination is removed.
  2. Visual inspection of completed substrate preparation to verify surface profile matches ICRI profile required for specified coating or finish, using ICRI standard rubber mold for visual comparison.
  3. Test tensile strength of the concrete surface according to ASTM C1583 Test Method to verify tensile strength of 200 psi minimum.
  4. Prepare field quality control report. Clearly indicate the locations, extents, and conditions of areas where surface preparation does not conform to specified profile and cleanliness. Document observed conditions with digital photographs.
  5. Repeat inspections when additional surface preparation for unsatisfactory conditions indicated in the previous field quality control report is completed.

#### **3.05 PROTECTION**

- A. Protect prepared concrete substrates from contamination. Reclean substrates that are contaminated by construction operations prior to installation of specified floor coatings or finishes.

**END OF SECTION**

## SECTION 09 0512

### CONCRETE FLOOR MOISTURE CONTENT AND PH TESTING

#### PART 1 GENERAL

##### 1.01 SUMMARY

- A. Concrete moisture content testing using relative humidity method.
- B. Concrete pH testing.

##### 1.02 RELATED REQUIREMENTS

- A. Pertinent section of Division 07 specifying water vapor emission control coating.
- B. Pertinent section of Division 09 specifying concrete floor preparation.
- C. Division 09 flooring sections specifying flooring and accessories requiring moisture and pH testing.

##### 1.03 REFERENCES

- A. ASTM F2170-09 Standard Test Method for Determining Relative Humidity in Concrete Floor Slabs Using in situ Probes.
- B. California Code of Regulations, Title 24, Part 11 California Green Building Standards Code, "CAL-Green".
- C. California Code of Regulations, Title 24, Part 2, California Building Code (CBC), International Building Code with California Amendments.

##### 1.04 ADMINISTRATIVE REQUIREMENTS

- A. Preinstallation Conference: Conduct conference at Project site to comply with requirements in Division 1 Section "Project Management and Coordination."
- B. Scheduling: Schedule work to permit concrete moisture testing to be completed minimum one week and maximum 3 weeks before floor coverings are installed.

##### 1.05 SUBMITTALS

- A. Product Data:
  - 1. Submit data indicating model, manufacturer, and calibration record for relative humidity measuring equipment.
  - 2. Submit data for pH test material products.
- B. Shop Drawings:
  - 1. Indicate test locations shown on building floor plan,
- C. Informational Submittals:
  - 1. Test Reports: Based on evaluation of comprehensive tests performed by a qualified testing agency, for concrete moisture acceptable limits. Report test results in chart form.
    - a. Relative Humidity Test Method: Indicate test dates, time, depth of test well, in-situ temperature, relative humidity and pH levels.
    - b. Submit record of ambient air temperature, ambient relative humidity, and floor slab surface temperature when test sites are prepared, start of test, and end of test.
    - c. Indicate condition of building enclosure including position of operable windows and exterior doors when test sites are prepared, start of test, and end of test.
    - d. Submit transcript of datalogger.

- e. Indicate operational status of HVAC systems maintaining environmental condition of spaces where tests are conducted when test sites are prepared, start of test, and end of test.

## **1.06 FIELD CONDITIONS**

### **A. Ambient Conditions:**

1. Do not perform concrete moisture testing until building is enclosed and HVAC system is operational.
2. Maintain building test areas at design operating conditions for minimum 48 hours before, during, and continuously after conducting testing.
3. When HVAC system is not operational at start of tests, maintain ambient conditions within test areas at 65 to 85 degrees F and 40 to 60 percent relative humidity for minimum 48 hours before, during, and continuously after conducting testing until building HVAC system is capable of maintaining design operating conditions.

## **PART 2 PRODUCTS**

### **2.01 RELATIVE HUMIDITY TEST EQUIPMENT**

- A. Manufacturers: Subject to compliance with requirements, provide products by one of the following:
  1. Vaisala [www.vaisala.com](http://www.vaisala.com).
  2. Wagner Moisture Meters, Rapid RH, [www.wagnermeters.com](http://www.wagnermeters.com).
  3. Substitutions: Section 01 6000.
- B. Humidity and Temperature Probe and Meter: Comply with ASTM F2170.

### **2.02 PH TEST MATERIALS**

- A. Manufacturers: Subject to compliance with requirements, provide products by one of the following:
  1. Micro Essential Laboratory [www.microessentiallab.com](http://www.microessentiallab.com).
  2. Substitutions: Section 01 6000.
- B. pH Test Paper: Capable of indicating minimum 7.0 to 13 pH range.
- C. pH Color Gage: Furnish pH test paper manufacturer's visual color gage to identify measured pH.
- D. Water: Distilled or de-ionized.

## **PART 3 EXECUTION**

### **3.01 EXAMINATION**

- A. Verify new concrete floors have cured minimum 28 days.

### **3.02 PREPARATION**

- A. When a building HVAC system is not operational and maintaining test areas at design operational conditions, install recording hygrometer or data logger in each separate test area to record ambient temperature and relative humidity beginning 48 hours before start of tests until completion of tests within each area.
- B. Identify three moisture test sites for first 1,000 sf and one moisture test site for each additional 1,000 sf of floor area receiving floor covering on each separate floor slab.
  1. Uniformly distribute test site locations throughout each test area.

### 3.03 FIELD QUALITY CONTROL

- A. Testing Agency: Owner will engage a qualified testing and inspecting agency to perform concrete moisture tests and inspections and prepare test reports.
  - 1. Test all concrete slabs (on grade and elevated) in accordance with ASTM F-2170, not more than 45 days prior to the installation of the finished flooring. Test all floors scheduled to receive adhered floor coverings, such as hardwood, wood athletic flooring, bamboo, carpet, resilient tile, resilient sheet goods, rubber, fluid-applied, cork tile, ceramic tile, cementitious and epoxy resin terrazzo, and porcelain tile.
- B. Acceptance Criteria at HVAC Design Operating Conditions:
  - 1. Relative Humidity Test Result: 75 percent maximum relative humidity.
  - 2. pH Test Result: Within alkalinity range of 7.0 to 9.0.
- C. Concrete Moisture Testing – General
  - 1. Conduct relative humidity test at each test site.
  - 2. Conduct one pH test at each test site.
- D. Relative Humidity Testing:
  - 1. Perform tests in accordance with ASTM F2170.
  - 2. Conduct relative humidity testing at the following depths:
    - a. Slabs-On-Grade: Measure temperature and relative humidity at 40 percent of slab thickness measured from top surface.
    - b. Elevated Slabs: Measure temperature and relative humidity at 20 percent of slab thickness measured from top surface.
  - 3. Drill test hole at each test site to accommodate test sleeve.
    - a. Hole Diameter: In accordance with test equipment manufacturer’s instructions.
    - b. Drilling Fluids: Not permitted.
  - 4. Vacuum dust and debris from test hole.
  - 5. Insert sleeve, to the full depth of test hole. Cap or plug sleeve to prevent test hole contamination.
  - 6. Permit the test site to acclimate for minimum 72 hours before measuring relative humidity.
  - 7. Remove sleeve plug and insert probe to bottom of test hole. Allow test probe to reach temperature equilibration with concrete slab.
  - 8. Measure and record temperature and relative humidity at the test site.
  - 9. Record and report results.
- E. pH Testing:
  - 1. Place several drops of water onto the concrete surface to form a puddle approximately 1 inch in diameter.
  - 2. Allow the water to set for approximately 60 seconds
  - 3. After 60 seconds, dip the pH paper into the water and remove immediately, compare color to chart provided by paper supplier to determine pH reading.
  - 4. Record and report results.

### 3.04 PROTECTION

- A. Protect tested concrete substrates from contamination. Reclean substrates that are contaminated by construction operations prior to installation of specified water vapor emission control coating, floor coatings or finishes.

**END OF SECTION**

**SECTION 09 2116  
GYPSUM BOARD ASSEMBLIES**

**PART 1 GENERAL**

**1.01 SECTION INCLUDES**

- A. Gypsum board furring systems.
- B. Shaft wall system.
- C. Gypsum wallboard.
- D. Joint treatment and accessories.
- E. Trim and accessories.
- F. Textured finish system.

**1.02 RELATED REQUIREMENTS**

- A. Section 01 6116 - Volatile Organic Compound (VOC) Content Restrictions.
- B. Section 06 1000 - Rough Carpentry: Building framing and sheathing.
- C. Section 07 2100 - Board and Batt [Building] Insulation.
- D. Section 07 8400 - Firestopping.
- E. Division 09: Pertinent sections specifying finishes installed over gypsum board substrates.
- F. Divisions 22 and 23: Pertinent sections specifying building utility systems penetrating gypsum board.

**1.03 REFERENCE STANDARDS**

- A. ANSI A108.11 - American National Standard Specifications for Interior Installation of Cementitious Backer Units; 2010 (Reaffirmed 2016).
- B. ANSI A118.9 - American National Standard Specifications for Test Methods and Specifications for Cementitious Backer Units; 1999 (Reaffirmed 2016).
- C. ASTM C475/C475M - Standard Specification for Joint Compound and Joint Tape for Finishing Gypsum Board; 2015.
- D. ASTM C557 - Standard Specification for Adhesives for Fastening Gypsum Wallboard to Wood Framing; 2003 (Reapproved 2009).
- E. ASTM C 635, Standard Specifications for Metal Suspension Systems.
- F. ASTM C 636, Recommended Practice for Installation of Metal Suspension Systems.
- G. ASTM C645 - Standard Specification for Nonstructural Steel Framing Members; 2014.
- H. ASTM C754 - Standard Specification for Installation of Steel Framing Members to Receive Screw-Attached Gypsum Panel Products; 2015.
- I. ASTM C840 - Standard Specification for Application and Finishing of Gypsum Board; 2013.
- J. ASTM C954 - Standard Specification for Steel Drill Screws for the Application of Gypsum Panel Products or Metal Plaster Bases to Steel Studs From 0.033 in. (0.84 mm) to 0.112 in. (2.84 mm) in Thickness; 2015.



- K. ASTM C1002 - Standard Specification for Steel Self-Piercing Tapping Screws for Application of Gypsum Panel Products or Metal Plaster Bases to Wood Studs or Steel Studs; 2014.
- L. ASTM C1047 - Standard Specification for Accessories For Gypsum Wallboard and Gypsum Veneer Base; 2014a.
- M. ASTM C1178/C1178M - Standard Specification for Coated Glass Mat Water-Resistant Gypsum Backing Panel; 2013.
- N. ASTM C1325 - Specification for Non-Asbestos Fiber-Mat Reinforced Cementitious Backer Units; 2014.
- O. ASTM C1396/C1396M - Standard Specification for Gypsum Board; 2014.
- P. ASTM C1629/C1629M - Standard Classification for Abuse-Resistant Nondecorated Interior Gypsum Panel Products and Fiber-Reinforced Cement Panels; 2015.
- Q. ASTM C1658/C1658M - Standard Specification for Glass Mat Gypsum Panels; 2013.
- R. ASTM D3273 - Standard Test Method for Resistance to Growth of Mold on the Surface of Interior Coatings in an Environmental Chamber; 2012.
- S. ASTM E84 - Standard Test Method for Surface Burning Characteristics of Building Materials; 2015a.
- T. ASTM E 119 - Standard Test Methods for Fire Tests of Building Construction and Materials; 1995a.
- U. ASTM E413 - Classification for Rating Sound Insulation; 2010.
- V. CISCA Ceiling Systems Installation Handbook.
- W. California Code of Regulations, Title 24, Part 2, California Building Code (CBC), International Building Code.
- X. California Code of Regulations, Title 24, Part 11, California Green Building Standards Code, "CAL-Green".
- Y. Division of the State Architect (DSA) Interpretation of Regulations: IR 25-3, Drywall Ceiling Suspension Conventional Construction One-Layer.
- Z. GA-214 - Recommended Levels of Gypsum Board Finish; Gypsum Association; 2007
- AA. GA-216 - Application and Finishing of Gypsum Board; 2013.
- AB. GA-226 - Application of Gypsum Board to Form Curved Surfaces; Gypsum Association; 2008.
- AC. California Building Code, Title 24, Part 2, California Building Code, Chapter 8.

#### **1.04 SUBMITTALS**

- A. See Section 01 3300 - Submittals, for submittal procedures.
- B. Provide complete submittals at the same time as submittals for work in related sections to permit review of complete and integrated systems and assemblies.
- C. Shop Drawings: Indicate special details associated with fireproofing and metal suspension systems.
  - 1. Reflected ceiling plans: Submit ceiling suspension system layout indicating dimensions, lighting fixture locations, and related mechanical components.

2. Assembly drawings: Indicate installation details, accessory attachments and installation of related lighting fixtures and related mechanical system components.
  3. System details: Submit manufacturer's catalogue cuts or standard drawing showing details of system with project conditions clearly identified and manufacturer's recommended installation instructions.
- D. Product Data: For each type of product indicated, demonstrate compliance with specified attributes.
- E. Product Data: Provide data on metal framing, gypsum board, accessories, and tackboard.
- F. CAL-GREEN Submittals: Product Data – VOC Limits: For adhesives sealants, fillers, primers and coatings, documentation including printed statement of VOC contents, comply with limits specified in related section.
- G. Samples: Submit two samples of gypsum board finished with proposed texture application, 12 by 12 inches (300 by 300 mm) in size, illustrating finish color and texture.
- H. Two samples 8 x 10 inch in size of tack board substrate, with manufacturer's labeling attached.

#### **1.05 QUALITY ASSURANCE**

- A. Perform in accordance with ASTM C 840. Comply with requirements of GA-600 for fire-rated assemblies.
1. Maintain one copy of standards at project site.
- B. Installer Qualifications: Company specializing in performing gypsum board installation and finishing, with minimum five years of experience.

#### **1.06 REGULATORY REQUIREMENTS**

- A. Conform to applicable code for fire rated assemblies as indicated on drawings.

### **PART 2 PRODUCTS**

#### **2.01 PERFORMANCE REQUIREMENTS**

- A. VOC Limits for adhesives, sealants, fillers, primers and coatings . Comply with limits specified in related section.

#### **2.02 BOARD MATERIALS**

- A. Manufacturers - Gypsum-Based Board:
1. Georgia-Pacific Gypsum: [www.gpgypsum.com](http://www.gpgypsum.com).
  2. National Gypsum Company: [www.nationalgypsum.com](http://www.nationalgypsum.com).
  3. PABCO Gypsum: [www.pabco gypsum.com](http://www.pabco gypsum.com).
  4. USG Corporation: [www.usg.com](http://www.usg.com).
- B. Gypsum Wallboard: Paper-faced gypsum panels as defined in ASTM C1396/C1396M; sizes to minimize joints in place; ends square cut.
1. Application: Use for vertical surfaces and ceilings, unless otherwise indicated.
  2. Glass mat faced gypsum panels as defined in ASTM C1658/C1658M, suitable for paint finish, of the same core type and thickness may be substituted for paper-faced board.
  3. Mold Resistance: Score of 10, when tested in accordance with ASTM D3273.
    - a. Mold resistant board is required at all locations.
  4. At Assemblies Indicated with Fire-Rating: Use type required by indicated tested assembly; if no tested assembly is indicated, use Type X board, UL or WH listed.
  5. Thickness:

- a. Vertical Surfaces: 5/8 inch.
- b. Ceilings: 5/8 inch.
- c. Multi-Layer Assemblies: Thicknesses as indicated on drawings.
6. Mold Resistant Paper Faced Products:
  - a. Georgia-Pacific Gypsum; ToughRock Fireguard X Mold-Guard.
  - b. National Gypsum Company; Gold Bond XP Gypsum Board.
  - c. Substitutions: See Section 01 6000 - Product Requirements.
7. Glass Mat Faced Products:
  - a. Georgia-Pacific Gypsum; DensArmor Plus Fireguard C.
  - b. National Gypsum Company; Gold Bond eXP Fire-Shield Interior Extreme Gypsum Panel.
  - c. Substitutions: See Section 01 6000 - Product Requirements.
- C. Impact Resistant Wallboard:
  1. Application: High-traffic areas indicated.
  2. Indentation: Level 1, minimum, when tested in accordance with ASTM C1629/C1629M.
  3. Soft Body Impact: Level 3, minimum, when tested in accordance with ASTM C1629/C1629M.
  4. Hard Body Impact: Level 2, minimum, when tested in accordance with ASTM C1629/C1629M.
  5. Mold Resistance: Score of 10, when tested in accordance with ASTM D3273.
  6. Paper-Faced Type: Gypsum wallboard as defined in ASTM C1396/C1396M.
  7. Type: Fire resistance rated Type X, UL or WH listed.
  8. Thickness: 5/8 inch.
  9. Edges: Tapered.
- D. Backing Board For Wet Areas:
  1. Application: Surfaces behind tile in wet areas including tub and shower surrounds and shower ceilings.
  2. Mold Resistance: Score of 10, when tested in accordance with ASTM D3273.
  3. ANSI Cement-Based Board: Non-gypsum-based; aggregated Portland cement panels with glass fiber mesh embedded in front and back surfaces complying with ANSI A118.9 or ASTM C1325.
    - a. Thickness: 1/2 inch.
    - b. Products:
      - 1) Custom Building Products: [www.custombuildingproducts.com/#sle](http://www.custombuildingproducts.com/#sle).
      - 2) National Gypsum Company; PermaBase Cement Board: [www.nationalgypsum.com/#sle](http://www.nationalgypsum.com/#sle).
      - 3) USG Corporation: [www.usg.com/#sle](http://www.usg.com/#sle).
  4. Glass Mat Faced Board: Coated glass mat water-resistant gypsum backing panel as defined in ASTM C1178/C1178M.
    - a. Fire Resistant Type: Type X core, thickness 5/8 inch.
    - b. Products:
      - 1) Georgia-Pacific Gypsum; DensShield Tile Backer.
      - 2) Substitutions: See Section 01 6000 - Product Requirements.
- E. Moisture-Resistant Gypsum Backing Board: ASTM C1396/C1396M; ends square cut. Fire-rated Type X where occurring in designated rated assemblies.
  1. Thickness: 5/8 inch.
  2. Edges: tapered.

### 2.03 Gypsum Wallboard ACCESSORIES

- A. Acoustic Insulation: Acoustic fiberglass batt type specified in Section 07 2100. Thickness as shown on drawings or as specifically noted; Provide to fill framing cavity depth otherwise.
- B. Board Insulation in furring cavities: Rigid polyisocyanurate, type specified in Section 07 2100.
- C. Finishing Accessories: ASTM C1047, galvanized steel or rolled zinc, unless otherwise indicated. Mechanically fastened.
  - 1. Types: As detailed or required for finished appearance.
  - 2. Special Shapes: In addition to conventional cornerbead and control joints, provide U-bead at exposed panel edges.
- D. Beads, Joint Accessories, and Other Trim: ASTM C1047, rigid plastic, galvanized steel, or rolled zinc, unless noted otherwise.
  - 1. Corner Beads: Low profile, for 90 degree outside corners.
    - a. Products:
      - 1) CertainTeed Corporation; No-Coat Drywall Corner: [www.certainteed.com/#sle](http://www.certainteed.com/#sle).
      - 2) ClarkDietrich; Strait-Flex Big-Stick: [www.clarkdietrich.com/#sle](http://www.clarkdietrich.com/#sle).
      - 3) Phillips Manufacturing Co; Everlast Corner Bead: [www.phillipsmfg.com/#sle](http://www.phillipsmfg.com/#sle).
      - 4) Substitutions: See Section 01 6000 - Product Requirements.
    - 2. Corner Beads: Low profile, for archways.
      - a. Products:
        - 1) ClarkDietrich; Strait-Flex Arch-Stick: [www.clarkdietrich.com/#sle](http://www.clarkdietrich.com/#sle).
    - 3. Expansion Joints:
      - a. Type: V-shaped metal with factory-installed protective tape.
  - E. Decorative Metal Trim:
    - 1. Material: Extruded aluminum alloy 6063-T5 temper.
    - 2. Finish: Anodized, clear.
    - 3. Type: Profile as selected from manufacturer's standard range.
    - 4. Corner Trim: As indicated.
    - 5. Reveal Trim: Fry DA.1; Width and Depth as indicated on Drawings, minimum 1/2 inch by 1/2 inch. If no dimensions are shown, request dimensions from Architect.
    - 6. Products:
      - a. Fry Reglet Corporation.
      - b. Substitutions: See Section 01 6000 - Product Requirements.
  - F. Joint Materials: ASTM C 475 and as recommended by gypsum board manufacturer for project conditions. Water resistant where used with water resistant backer board.
    - 1. Tape: 2 inch (50 mm) wide, creased paper tape for joints and corners, USG "Perf-A-Tape", or equal.
    - 2. Joint Compound: Drying type, vinyl-based, ready-mixed.
  - G. Finishing Compound: Surface coat and primer, takes the place of skim coating.
  - H. High Build Drywall Surfacers: Vinyl acrylic latex-based coating for spray application, designed to take the place of skim coating and separate paint primer in achieving Level 5 finish.
  - I. Screws for Fastening of Gypsum Panel Products to Cold-Formed Steel Studs Less than 0.033 inch (0.84 mm) in Thickness and Wood Members: ASTM C1002; self-piercing tapping screws, corrosion resistant.

- J. Screws for Fastening of Gypsum Panel Products to Steel Members from 0.033 to 0.112 inch (0.84 to 2.84 mm) in Thickness: ASTM C954; steel drill screws, corrosion resistant.
- K. Anchorage to Substrate: Tie wire, nails, screws, and other metal supports, of type and size to suit application; to rigidly secure materials in place.
- L. Adhesives
  - 1. Modified contact adhesive: As recommended by the gypsum board manufacturer and having a placement time before setting of at least 15 minutes.
  - 2. Joint compound adhesive: As recommended by the gypsum board manufacturer.

### **PART 3 EXECUTION**

#### **3.01 EXAMINATION**

- A. Verify that project conditions are appropriate for work of this section to commence.
- B. Verify that framed substrates demonstrate flatness characteristics such that work of this section will meet specified tolerances.

#### **3.02 INSTALLATION - GENERAL**

- A. Install materials in accordance with gypsum board application and finishing standards referenced.
  - 1. Single layer application: Screw attachment.
  - 2. Float interior angles, except where required to conform to fire or acoustical separation requirements.
  - 3. Do not install scored, scratched, broken, damp, or otherwise damaged boards.
  - 4. Smooth cut edges and ends to obtain neat fitting joints.

#### **3.03 ACOUSTIC ACCESSORIES INSTALLATION**

- A. Acoustic Insulation: Place tightly within spaces, around cut openings, behind and around electrical and mechanical items within partitions, and tight to items passing through partitions.
- B. Acoustic Sealant: Install in accordance with manufacturer's instructions.
  - 1. Place one bead continuously on substrate before installation of perimeter framing members.
  - 2. Place continuous bead at perimeter of each layer of gypsum board.
  - 3. Seal around all penetrations by conduit, pipe, ducts, and rough-in boxes, except where firestopping is provided.

#### **3.04 BOARD INSTALLATION**

- A. Comply with ASTM C840, GA-216, and manufacturer's instructions. Install to minimize butt end joints, especially in highly visible locations.
- B. Single-Layer Non-Rated: Install gypsum board in most economical direction, with ends and edges occurring over firm bearing.
- C. Double-Layer Non-Rated: Use gypsum board for first layer, placed parallel to framing or furring members, with ends and edges occurring over firm bearing. Use glass mat faced gypsum board at exterior walls and at other locations as indicated. Place second layer perpendicular to framing or furring members. Offset joints of second layer from joints of first layer.

- D. Fire-Rated Construction: Install gypsum board in strict compliance with requirements of assembly listing.
- E. Exposed Gypsum Board in Interior Wet Areas: Seal joints, cut edges, and holes with water-resistant sealant.
- F. Impact Resistant Gypsum Board: Install as for gypsum board. Do not install over faced insulation or other vapor-retarders.
- G. Cementitious Backing Board: Install over steel framing members and plywood substrate where indicated, in accordance with ANSI A108.11 and manufacturer's instructions.
- H. Installation on Metal Framing: Use screws for attachment of gypsum board except face layer of non-rated double-layer assemblies, which may be installed by means of adhesive lamination.
- I. Installation on Wood Framing: For rated assemblies, comply with requirements of listing authority. For non-rated assemblies, install as follows:
  - 1. Single-Layer Applications: Screw attachment.
  - 2. Double-Layer Applications: Install base layer using screws. Install face layer by screws.
- J. Curved Surfaces: Apply gypsum board to curved substrates in accordance with GA-226.
- K. Moisture Protection: Treat cut edges and holes in moisture resistant gypsum board with sealant.

### **3.05 INSTALLATION OF TRIM AND ACCESSORIES**

- A. Control Joints: Place control joints consistent with lines of building spaces and as directed.
- B. Corner Beads: Install at external corners, using longest practical lengths.
- C. Edge Trim: Install at locations where gypsum board abuts dissimilar materials.

### **3.06 JOINT TREATMENT**

- A. Glass Mat Faced Gypsum Board and Exterior Glass Mat Faced Sheathing: Use fiberglass joint tape, embed and finish with setting type joint compound.
- B. Finish gypsum board in accordance with levels defined in ASTM C 840, and required by Section 09 9000 Painting and Coating, as follows:
  - 1. Level 5: Corridor walls to receive eggshell paint finish.
  - 2. Level 5: Walls and ceilings to receive semi-gloss or gloss paint finish and other areas specifically indicated.
  - 3. Level 4: Walls and ceilings to receive paint finish or wall coverings, unless otherwise indicated.
  - 4. Level 3: Walls to receive textured wall finish.
  - 5. Level 3: Ceilings to receive glued on acoustical ceiling tiles.
  - 6. Level 2: Behind cabinetry and on backing board to receive tile finish.
  - 7. Level 1: Fire rated wall areas above finished ceilings, whether or not accessible in the completed construction.
- C. Tape, fill, and sand exposed joints, edges, and corners to produce smooth surface ready to receive finishes.
  - 1. Feather coats of joint compound so that camber is maximum 1/32 inch (0.8 mm).

- D. Where Level 5 finish is indicated, spray apply high build drywall surfacer over entire surface after joints have been properly treated; achieve a flat and tool mark-free finish.

**3.07 TEXTURE FINISH**

- A. Apply finish texture coating by means of spraying apparatus in accordance with manufacturer's instructions and to match approved sample.
- B. Texture Required: .
  - 1. Finish Texture: Medium Orange Peel at walls and ceiling unless otherwise noted.
  - 2. No finish texture at Level 5 joint treatment walls and ceilings as noted.

**3.08 TOLERANCES**

- A. Maximum Variation of Finished Gypsum Board, Tack Board, or Cementitious Board Surface from True Flatness: 1/8 inch in 10 feet (3 mm in 3 m) in any direction.

**END OF SECTION**

## SECTION 09 2513

### ACRYLIC-MODIFIED PORTLAND CEMENT PLASTER

#### PART 1 GENERAL

##### 1.01 SECTION INCLUDES

- A. Acrylic-Modified Portland cement plaster assemblies for installation over metal lath.
  - 1. Over framed substrates.
  - 2. Over solid substrates.
  - 3. Over architectural foam shapes.
  - 4. As substrate for adhered veneer or tile.
  - 5. As substrate for custom polymer texture finishes.

##### 1.02 RELATED SECTIONS

- A. Pertinent Sections specifying Volatile Organic Compound (VOC) Content Restrictions.
- B. Section 04 2200 - Concrete Unit Masonry
- C. Sections specifying structural support framing for plaster.
- D. Section 07 2500 specifying Weather Barriers.
- E. Section 07 6200 - Sheet Metal Flashing and Trim.
- F. Section 07 9200 - Joint Sealers.
- G. Sections specifying work penetrating plaster assemblies.
- H. Sections specifying adhered veneers and tile installed on plaster substrates.

##### 1.03 REFERENCES

- A. California Building Code (CBC) Title 24, Part 2, Chapter 25 and DSA IR 25-4.
- B. California Code of Regulations, Title 24, Part 11 California Green Building Standards Code, "CAL-Green".
- C. ASTM C 847 - Standard Specification for Metal Lath.
- D. ASTM C 926 - Standard Specification for Application of Portland Cement-Based Plaster; 1998a.
- E. ASTM C 1032 - Standard Specification for Woven Wire Lath
- F. ASTM C1063 - Standard Specification for Installation of Lathing and Furring to Receive Interior and Exterior Portland Cement-Based Plaster.
- G. Manufacturer's specifications and recommendations.

##### 1.04 SUBMITTALS

- A. See Section 01 3300 - Submittals, for submittals procedures.
- B. Product Data: Provide data on plaster materials, characteristics and limitations of products specified. Include mix design for each coat. Demonstrate compliance with specified requirements.
- C. CAL-GREEN VOC Submittals: For adhesives sealants, fillers, coatings and primers, documentation including printed statement of VOC contents, comply with limits specified in related section.



- D. Samples: Submit two samples, 12 x 12 inch (\_\_\_\_x\_\_\_\_ mm) in size illustrating finish color and texture. Provide color samples of sealants. Provide physical samples of each type of fastener and anchorage.
- E. Shop Drawings:
  - 1. Location, installation and pattern, fully dimensioned, of all control joints, expansion joints, embedments, inserts, penetrations and all other items that will visually affect the plaster surface for all visible portions of the plaster surfaces.
  - 2. Shop drawings shall be to scale and depict all visible surfaces.
  - 3. Include plans, elevations, sections, details of components, and attachments to other work.
  - 4. Locations and installation details of architectural foam shapes, including accessories, flashings and sealing.
  - 5. Location of all elements and joints is subject to approval of the Architect.
- F. Installer's Qualification statement.
- G. Warranties: Special warranties specified in this Section.

#### **1.05 QUALITY ASSURANCE**

- A. Perform Work in accordance with ASTM C 926.
- B. Regulatory requirements: All plaster work shall be performed in accordance with requirements of California Building Code (CBC) Title 24, Part 2, Chapter 25, ASTM C1063 and DSA IR 25-4.
- C. Fire-Resistance Ratings: Where fire resistance ratings are indicated on the drawings, provide portland cement plaster assemblies identical to those of assemblies tested for fire resistance per ASTM E 119 by a qualified testing agency. Identify products with appropriate markings of applicable testing agency.
  - 1. Conform to California Building code for fire rated assemblies as indicated on drawings.
  - 2. Coordinate components of fire rated assemblies with materials specified for support of plaster in other sections.
- D. Sound-Transmission Characteristics: Where indicated, provide portland cement plaster assemblies identical to those of assemblies tested for STC ratings per ASTM E 90 and classified according to ASTM E 413 by a qualified testing agency.
- E. Manufacturer Qualifications: Company specializing in manufacturing the products of this section with minimum five years of documented experience.
- F. Installer Qualifications: Installer shall be listed with Acrylic-Modified Portland Cement Plaster Systems Manufacturer as a trained contractor and shall possess a current Manufacturer-trained contractor certificate.

#### **1.06 MOCK-UP**

- A. Construct mock-up of exterior wall, 8 feet long by 8 feet wide, illustrating surface finish.
  - 1. Locate where directed.
  - 2. Mock-up may remain as part of the Work.
- B. Mockups: Build mockups to demonstrate aesthetic effects and set quality standards for materials and execution.
  - 1. Within 120 days of mobilization, provide minimum 4'-0" x 12'-0" x 8'-0" tall onsite mock up, including field area, outside corner, full window opening (with window, head and jamb trim and sill), and representative examples of other design conditions for review and approval by Architect prior to commencing actual work.

- a. Combine mockup with that specified for adhered veneer cladding in related section(s). Show relationships and transitions between materials.
  - b. Use adhered veneer selected by verification samples.
  - c. Demonstrate the proposed range of color, texture and workmanship to be expected in the completed work, including Specialty Finishes where indicated.
  - d. Include through-wall flashing installed for a 24-inch length in corner of mockup approximately 16 inches down from top of mockup, with a 12-inch length of flashing left exposed to view (omit finish above half of flashing).
  - e. Include framing studs, sheathing, flashing in exterior wall mockup.
  - f. Show a cut-away in the panel exposing the water-resistive barriers, metal lath and drainage weep of the system on a perimeter edge of the panel.
  - g. Install plaster over the top of the mockup to duplicate the project plaster parapet, including waterproofing material and parapet cap.
  - h. Include foundation weep screed, corner trim, vertical expansion joint and horizontal control joint.
  - i. Include a sealant-filled joint at least 48 inches long in mockup.
  - j. Construct additional panels until finish, color and consistency is approved by Architect.
2. Obtain Architect's acceptance of visual qualities of the sample panel. Approval of mockups is for color, texture, tooling of joints; and aesthetic qualities of workmanship.
    - a. Approval of mockups is also for other material and construction qualities Architect specifically approves in writing, including required tests of installed windows, as described in related Sections specifying Windows and Curtain Wall.
    - b. Approval of mockups does not constitute approval of deviations from the Contract Documents contained in mockups unless Architect specifically approves such deviations in writing.
  3. Mock up or portions of mockup may require more than one iteration and shall be erected in a long term location near the building.
  4. Approved mockup will become the standard for comparison for Architect's judging aesthetic qualities of the finished work.
  5. Maintain and protect mockup throughout the construction process and dispose of when project is completed.

#### **1.07 FIELD CONDITIONS**

- A. Do not apply plaster when substrate or ambient air temperature is outside the manufacturer's recommended ranges.
- B. Maintain manufacturer's recommended minimum ambient temperature during installation of plaster and until cured.
- C. Application of materials shall not take place during inclement weather unless appropriate protection is provided. Protect materials from inclement weather.
- D. Load roofing materials onto the roof and stock interior gypsum wallboard in the building prior to the installation of cement plaster.
- E. Protect the materials from uneven and excessive evaporation in warm windy weather. Always work the shady side of the wall.

#### **1.08 WARRANTY**

- A. Warranty: Standard form in which manufacturer agrees to repair or replace plaster system finishes that fail in materials or workmanship within specified warranty period.
  1. Failures include, but are not limited to, the following:
    - a. Manufacturing defects.
    - b. Structural failures including cracking in excess of 3/32 -inch or by PCA standards.

- c. Shrinkage.
  - d. Finish coat color fading.
  - e. Failure of system to resist penetration of water.
  - f. Failure of system to resist damage from wind.
  - g. Hairline cracking due to temperature or shrinkage is not considered structural failure.
2. Single Source System Warranty Period: 15 years from date of Substantial Completion covering base coats, lamina, primer and 100% acrylic or elastomeric finish.
- B. Assist the Owner to properly execute the warranty request forms.

## **PART 2 PRODUCTS**

### **2.01 SYSTEM DESCRIPTION**

- A. VOC Limits for adhesives sealants, fillers and primers. Comply with limits specified in related section.
- B. Design Requirements:
1. Extend complete plaster assembly behind surface installed fixtures and trim.
  2. Two layers of building paper beneath lath at all locations.
- C. Provide Products exhibiting the following characteristics when tested as follows:
1. ASTM C 109: Compressive Strength: 13.9 Mpa (2020 psi)
  2. ASTM C 348: Flexural Strength: 3.0 Mpa (570 psi)
  3. ASTM C 190: Tensile Strength: 1.2 Mpa(180 psi)
  4. ICBO Procedure: Freeze/Thaw cycling: No cracking, checking or delamination
  5. ASTM E 514: Water Vapor Permeability: 415 ng/ (7.2 Perms)
  6. ASTM E 72: Transverse Load Strength: Wood Studs - 468.7 kg. m2 (96 psf) Metal Studs -673.8 kg/ m2 (138 psf)
  7. ASTM E 119: Fire Resistive Wall Assembly, acceptable as part of One-Hour Assembly.
  8. MIL STD 810B: Mildew Fungus Resistance -Passed
  9. ASTM B 117: Salt Spray Resistance - 300 hrs, no deleterious effects.
  10. ASTM D 968: Abrasion Resistance - 500 L(132 gal), no deleterious effects.
  11. ASTM G 53: Accelerated Weathering - 5000 hrs, Passed.
- D. Expansion Control: Design orientation, and location of expansion and control joints shall be determined by the Architect and as shown on the drawings. If joints are required by the following criteria and are not shown on the drawings, recommend joint locations on Shop Drawings for the Architect's approval. Do not modify aesthetic effect of joint locations shown on drawings or provide joints not shown on drawings without Architect's written approval.
1. Expansion Joints: Required at the following locations:
    - a. Where expansion joints occur in the substrate system.
    - b. Where building expansion joints occur.
    - c. At floor lines.
    - d. Where plaster abuts dissimilar materials.
    - e. Where the substrate material changes.
    - f. Where significant structural movement occurs such as changes in roofline, building shape or structural system.
  2. Control joints: Horizontal and Vertical, required in accordance with ASTM C 1063 and as indicated on the contract drawings in the following locations:
    - a. Corners of openings
    - b. Such that monolithic wall areas do not exceed 144 ft2.
    - c. Length to width ratios of wall areas shall not exceed 2.5:1.
    - d. Maximum spacing of control joints shall not exceed 18 ft.
    - e. At intersections of natural breaks in walls and above opening jambs.

- E. Performance Requirements:
  - 1. Finish surfaces flat, true, and plumb to plus or minus 1/4-inch in 10 feet.
  - 2. Provide weather tight assembly.

## 2.02 MANUFACTURER

- A. Source Limitations: All components of the Acrylic-Modified Plaster System shall be provided from a single manufacturer.
- B. Provide factory-mixed plaster. Job-site mixed plaster is not acceptable.
  - 1. Provide ready-mixed products in minimum 90 lb. sacks, supersacks or in pre-mixed silos.
- C. Basis of Design Products:
  - 1. BMI 690 Plaster with 100 % Acrylic Primer & Finish, manufactured by BMI Products, 990 Ames Avenue, Milpitas, CA 95035-6303, (408) 293-4008, www.bmi-products.com.
    - a. ICC-ES Report ESR 2535.
- D. Acceptable Alternate:
  - 1. Dryvit CCP with TAFS (Textured Acrylic Finishes).
- E. Substitutions: See Section 01 6000.

## 2.03 PLASTER MATERIALS

- A. Plaster Base Coat: "BMI 690 Plaster": A premium pre-blended cement-lime-sand mixture with fiber that has been specially formulated for the scratch and brown coat. This pre-blended product assures consistent quality throughout the project.
- B. Polymer-Modified Base Coat: Apply in thin layer over Brown Coat as Lamina/Leveling Coat to embed reinforcing lamina and mesh and provide uniform substrate for finish application.
  - 1. BMI 777 base coat, fiber-reinforced, high-performance polymer modified dry cementitious base coat specifically formulated for use in embedding mesh. Mix with water per instructions.
- C. Reinforcing Mesh: "Standard Reinforcing Mesh": Open-weave fiberglass mesh with integral treatment for related materials compatibility. Manufacturer's standard products in 4.5 oz and 6.0 oz./ sq. yd. as appropriate for application.
- D. Primer: 100% acrylic color primer; Water-based, pigmented acrylic primer applied over the cured plaster base coat to improve adhesion and provide more uniform finish appearance.
  - 1. BMI 100 Acrylic Primer.
- E. Textured Finish: 100% acrylic finish with integral color and texture.
  - 1. BMI 400 Medium Finish, "Sandblast" medium texture. Color as noted in drawings.

## 2.04 WEATHER-RESISTIVE BARRIER

- A. Building Paper: Type specified in related Section 07 2500.
- B. Flexible Flashing: Type specified in related Section 07 2500.
- C. Sheet Metal Flashing: Type specified in related Section 07 6200.

## 2.05 METAL LATH

- A. Lath:
  - 1. Sheathed Framed Walls: Metal Lath conforming to CBC Chapter 25, ASTM C847, ASTM C1032 and ASTM C1063, un-backed, for installation over two continuous layers of building paper as required by code.

- a. Metal Lath: Self-Furred Diamond Mesh Metal Lath (grooved), ASTM C 847 with ASTM A 653/A 653M, G60 (Z180), hot-dip galvanized zinc coating, 2.5 lbs/sq.yd. as manufactured by CEMCO, [www.cemcosteel.com](http://www.cemcosteel.com).
  - b. Welded Wire Lath: 1.14 lbs/sq.yd., galvanized steel, "Structalath, No.17, SF CR Twin trac" (ICC ESR-2017) as manufactured by Structa Wire Lath, [www.structawire.com](http://www.structawire.com).
  - c. Woven Wire Fabric lath: ASTM C1032, 1-1/2 inch opening, 17 gauge, self-furring with stiffener wire, un-backed.
2. Framed horizontal soffits:
- a. Flat Rib Expanded metal lath, ASTM C847 with ASTM A 653/A 653M, G60 (Z180), hot-dip galvanized zinc coating: 3.4 lbs./sq. yd., galvanized steel, 3/8 inch rib as manufactured by CEMCO.
  - b. Welded wire lath: 2.2lbs./sq.yd., galvanized steel, paper backed "V Truss Wall & Ceiling - Rib lath" (ICC ESR-2017) as manufactured by Structa Wire Lath, [www.structawire.com](http://www.structawire.com).
- B. Lath Anchorage: Nails, or other metal supports conforming to requirements of referenced standards, of type and size to suit application and conforming to requirements of CBC Chapter 25 for conditions indicated, galvanized, to rigidly secure lath and associated metal accessories in place.
1. Install metal lath on sheathed framed walls using only specified fasteners. Staples are not permitted for lath attachment on walls.
  2. Install expanded metal lath on framed horizontal soffits using specified fasteners, staples and j-nails as detailed on the Drawings. Staples may be provided only where specifically detailed on the Drawings.

## 2.06 LATH ACCESSORIES

- A. General: Galvanized steel, unless otherwise specified.
- B. Manufacturers:
1. Alabama Metal Industries Corporation (AMICO); a Gibraltar Industries company.
  2. CEMCO.
  3. Clark Western Building Systems.
  4. Stockton Products, [www.stocktonproducts.com](http://www.stocktonproducts.com).
  5. Substitutions: Section 01 6000.
- C. Reinforcement
1. Interior Corners: CEMCO, No. 30 Corner Expansion Joint.
  2. Exterior Corners: CEMCO No. 1A Expanded Corner Bead.
- D. Screeds and Molds: Per Plaster and Drywall Systems Manual, size and profile as indicated on the Drawings and as necessary to suit application.
1. 22 gauge galvanized steel. Hem exposed edges. Furnish in longest possible lengths.
  2. Furnish drip screeds with weep holes every 2-inches.
- E. Expansion and Control Joints
1. Vertical Joints
    - a. Control Joints: CEMCO No.XJ-15; Size as noted on Drawings.
    - b. Expansion Joints: CEMCO No. 40; Size as noted on Drawings.
  2. Horizontal Control Joints: CEMCO No. 15; Size as noted on Drawings.
  3. Two-Piece Expansion Joints (story drift): Fabricated from zinc or zinc-coated (galvanized) steel; formed to produce slip-joint and square-edged reveal that is adjustable from 1/4 -inch to 5/8 -inch wide; with perforated flanges. Fabricate with 3 -inch minimum vertical legs.
  4. Diagonal Joints: Type as noted on Drawings.

- F. Extruded Aluminum Accessories: Provide components fabricated from 6063-T5 aluminum alloy and temper. Provide metal reveals, drip screeds, and other shapes and sizes as indicated on the Drawings, in sizes required for plaster thickness.
1. Manufacturer:
    - a. Fry Reglet Corporation; [www.fryreglet.com](http://www.fryreglet.com).
    - b. Substitutions: Section 01 6000. Acceptance is subject to compliance with specified design criteria, as evidenced by submittal of specified product data.
  2. Narrow V-screeds for horizontal soffits: Profiles as indicated on the Drawings.
  3. Stress Relief for Expansion and Control Joints: WLPDIA Detail 40 stress relief control joints, as dimensioned on the Drawings.
  4. Expansion screeds shall be 2-piece split plaster channel type equal to Fry Reglet PCS-75-25 2-PC.
    - a. Expansion screeds and vent screeds: Provide with nonstaining strippable tape or other suitable protective material to prevent plugging of perforations.
  5. Provide factory fabricated channel screed connector clips for alignment of intersections and splices.
  6. Clear Anodized Finish: Architectural 200R1 medium etch (AA-M32c10A21), clear color.

## 2.07 MISCELLANEOUS MATERIALS

- A. Water for Mixing: Potable and free of substances capable of affecting plaster set or of damaging plaster, lath, or accessories.
- B. Base Coat Fiber Reinforcing: Propex Concrete Systems, [www.fibermesh.com](http://www.fibermesh.com), "FiberCast 500®"; 100% virgin polypropylene, fibers containing no reprocessed olefin materials and specifically manufactured for use as cementitious micro-reinforcement; ASTM C 1116, Type III 4.1.3, performance level 1. and ACI 524R-93. Detergent admixtures or clay to aid in pumping plaster will not be permitted.
- C. Crack Limitation Membrane: Resin coated, open weave, glass fiber mesh treated for compatibility with base coat material; weight: 4.5 oz./square yard minimum weight.
- D. Bonding Compound: ASTM C 932.
- E. Wire: ASTM A 641/A 641M, Class 1 zinc coating, soft temper, not less than 0.0475 -inch (1.21-mm) diameter, unless otherwise indicated.

## 2.08 SEALANT

- A. Single-Component, Nonsag, Neutral-Curing Silicone Joint Sealant: ASTM C 920, Type S, Grade NS, Class 100/50, for Use NT, complying with requirements of related Section 07 9005. Type as recommended by wall finish manufacturer for conditions indicated, and as required to maintain single-source warranty continuity.
  1. Color: As selected by Architect from manufacturer's standards.

## 2.09 PLASTER MIXES

- A. General: Comply with ASTM C 926 for applications indicated.
- B. Base Coat: BMI 690 basecoat, is a pre-blended product and therefore can be mixed in a continuous mixer or a mechanical plaster mixer.
- C. Mix per manufacturer instructions for three minutes, but never more than five minutes, Do NOT over mix.
- D. Traditional application or scratch and brown coat, double back method of application, or single pass of basecoats 3/4 inch - 7/8 inch in thickness is acceptable based on BMI Products ICC-ES Report ESR 2535.

E. Protect mixtures from freezing, frost, contamination, and excessive evaporation.

F. Do not retemper mixes after initial set has occurred.

### **PART 3 EXECUTION**

#### **3.01 EXAMINATION**

A. Examine substrates and conditions, with Installer present, for compliance with requirements for installation tolerances and other conditions affecting performance of the Work.

B. Proceed with installation only after unsatisfactory conditions have been corrected.

C. Framed Substrates: Verify that sheathing, weather barriers, continuous insulation, building papers and flashings specified in related sections are complete and ready to receive work of this section.

D. Masonry: Verify joints are cut flush and surface is ready to receive work of this section. Verify no bituminous or water repellent coatings exist on masonry surface.

E. Concrete: Verify surfaces are flat, honeycomb are filled flush, and surfaces are ready to receive work of this section. Verify no bituminous, water repellent, or form release agents exist on concrete surface that are detrimental to plaster bond.

F. Mechanical and Electrical: Verify services within walls have been tested and accepted.

#### **3.02 PREPARATION**

A. Protect adjacent work from soiling, spattering, moisture deterioration, and other harmful effects caused by plastering.

B. Prepare smooth, solid substrates for plaster according to ASTM C 926.

#### **3.03 INSTALLATION, GENERAL**

A. Fire-Resistance-Rated Assemblies: Install components according to requirements for design designations from listing organization and publication indicated on Drawings.

#### **3.04 LATHING**

A. Metal Lath: Install according to ASTM C 1063 and as detailed on the Drawings. Fasten securely in place.

B. General: Comply with CBC Table 2507.2 and the following;

1. Install metal lath taut, using only specified and detailed fasteners, with long dimension perpendicular to supports, over sheathing and water-resistive barrier at walls and over ceiling framing at soffits, as indicated.
2. Attach at maximum 6 -inch intervals conforming to requirements of ASTM C1063.
  - a. Use wire ties or screws at metal framing and powder driven wide-shouldered forced entry fasteners at solid metal backing.
  - b. All fasteners shall penetrate into structural support.
  - c. Use furring nails and hook staples only as detailed at wood framed soffits.
3. Lap sides not less than 1/2 -inch and ends not less than 1 -inch. Lap wire fabric not less than one mesh at sides and ends or 1 -inch, whichever is greater. Lap rib lath at sides by nesting outside ribs. Stagger ends to differing supports and lap.
4. Where solid backing is not provided, securely tie ends of lapped sheets not occurring over supports with minimum 18-gauge tie wire.
5. Reinforce internal and external corners with lath.
  - a. Continuously reinforce internal angles with corner mesh, return metal lath 3 -inches from corner to form the angle reinforcement; Fasten only at perimeter edges.

6. Insert lath as far as possible into reentrant space of metal frames, and notch to pass around jamb anchors.
- C. Horizontal Surfaces: Install as specified for vertical surfaces except attach ribbed lath to horizontal supports with wire ties or hook staples as described in CBC 2507.3 in addition to the methods described in Table 2507.2. Install as specifically detailed on drawings.

### 3.05 ACCESSORY INSTALLATION

- A. Fasten accessories in place at both ends and at a maximum of 12 -inches on center along sides, and as required to prevent dislodging or misalignment by subsequent operations.
- B. Install accessories to provide required depth of plaster and to bring plaster surface to required plane.
- C. Set accessories straight, plumb, level and true to line. Shim as required to proper grounds. Align joints with concealed splices or tie plates. Trim or cope screeds and accessories to coordinate, lap or be lapped with flashings and work provided by other sections. Ensure all laps of accessories and flashings weather to exterior and away from flow direction of water behind the plaster.
- D. Neatly miter or cope corners and intersections of accessories to fit exposed edges. Make tight hairline joints.
- E. Butt and align accessory joints at ends and intersections and seal. Vertical accessories shall run continuous, interrupting horizontal accessories.
- F. Continuously reinforce angles and fasten only at perimeter edges. Connect lengths of accessories as recommended by the manufacturer to assure a continuous line.
- G. Extend accessories into niches and recesses, around interior and exterior wall corners, and around all sides of columns and similar building elements. Continue control joint patterns and molding alignments on walls of arcades, passages and all similar locations to match or extend those shown on exterior elevations, whether or not individual conditions are specifically shown, noted or elevated.
  1. Locations and extents indicated on drawings are the minimum required. If joints shown on the drawings are fewer, recommend joints as specified here and request confirmation of layout by Architect.
- H. Weep Screeds - Foundation: Provide typically and as indicated.
  1. Install foundation weep screeds at all bottom of walls to receive lath and plaster.
  2. Place the bottom edge of the foundation weep screed not less than 1 -inch (25 mm) below the joint formed by the foundation and framing.
  3. The nose of the screed shall be placed not less than 4 -inches (102 mm) above raw earth.
  4. The nose of the screed shall be placed not less than 2 -inches (51 mm) above paved surfaces.
  5. The weather resistant barrier (Building Papers) and lath shall entirely cover the vertical attachment flange and terminate at the top edge of the nose or ground flange.
- I. Beads and Reinforcements:
  1. Use single length of metal beads wherever length of run does not exceed longest standard stock length available.
  2. Provide casing beads at terminations of plaster finish and at the following locations. Butt and align ends. Secure rigidly in place:
    - a. Where plaster abuts another material or dissimilar construction.
    - b. At perimeter of openings where edges of plaster will not be concealed by other work
    - c. Locations indicated and where an exposed plaster edge would occur otherwise.
  3. Corner Beads: Install for full length of outside corners, fastened at outer edges only.



4. Cornerite Reinforcements: Install at inside corners, except where lath is carried around corners at least 3 -inches (75 mm).
5. Strip Lath Reinforcement:
  - a. Reinforce corners of openings diagonally with 9 -inch by 24 -inch strips of metal lath, tied to reinforcement.
  - b. Place 4-inch wide strips of metal lath centered over junctions of dissimilar backing materials. Secure rigidly in place.
6. Stress Relief Joints: Space joints as indicated on Contract Drawings. Locations and extents indicated on drawings are the minimum required. If joints shown on the drawings are fewer than minimum required by this specification, recommend joints as specified here and request confirmation of layout by Architect.
  - a. Coordinate joint placement to preserve visual alignment with other work acceptable to Architect.
  - b. Cut and separate reinforcement behind expansion and control joints.
  - c. Use double casing bead spaced 1/4-inch (6 mm) apart to form joint.

### 3.06 PREPARATION - SOLID BASES

- A. Dampen masonry surfaces to reduce excessive suction.
- B. Clean concrete surfaces of foreign matter. Clean surfaces using acid solutions, solvents, or detergents. Wash surfaces with clean water.
- C. Roughen smooth concrete surfaces and apply bonding agent in accordance with manufacturer's instructions.

### 3.07 PLASTERING

- A. General: Comply with ASTM C 926.
  1. Do not deviate more than plus or minus 1/4 inch in 10 feet (6 mm in 3 m) from a true plane in finished plaster surfaces when measured by a 10-foot (3-m) straightedge placed on surface.
  2. Finish plaster flush with metal frames and other built-in metal items or accessories that act as a plaster ground unless otherwise indicated. Where casing bead does not terminate plaster at metal frame, cut base coat free from metal frame before plaster sets and groove finish coat at junctures with metal.
  3. Provide plaster surfaces that are ready to receive field-applied finishes indicated.
- B. Apply plaster in accordance with manufacturer's instructions, and ICC-ES Report.
- C. Three-Coat Application Over Metal Lath per manufacturer unstructions, or for field-mixed plaster:
  1. Apply first coat to a nominal thickness of 3/8 inch (9 mm). Apply plaster scratch coat to embed lath completely so that no lath is visible. Scratch or score vertical surfaces horizontally at even intervals for mechanical key.
  2. Apply second coat to a nominal thickness of 3/8 inch (9 mm) once the first coat is sufficiently rigid to accept the application without being disturbed. Apply evenly, using a rod, darby or other straightedge, bring surface t to a true, even plane, flush with plaster grounds.
  3. Float surface with a wood or hard rubber float to promote densification and ensure a surface with adequate "tooth" receptive to bonding of the finish coat.
  4. Apply finish coat to a nominal thickness of 1/8 inch (3 mm) per manufacturer instructions.
- D. Three-Coat Application Over Solid Bases:
  1. Bonding Compound: Apply on unit masonry and concrete substrates for direct application of plaster.
  2. Apply first coat to a nominal thickness of 1/4 inch (6 mm).

3. Apply second coat to a nominal thickness of 1/4 inch (6 mm).
  4. Apply finish coat to a nominal thickness of 1/8 inch (3 mm).
- E. Curing: Base requires adequate moisture to allow continuous hydration of the cement.
1. Minimum four (4) days of moist curing shall be provided.
  2. Provide additional moist curing to conform to code requirements, manufacturer recommendations, local practices and climatic conditions and as otherwise required to provide acceptable substrate for finish coat.
  3. Base coat shall be allowed to cure for a minimum of 7 days prior to coating with primer and textured finish.
- F. Reinforced Leveling Coat:
1. Ensure that the surface of the wall is cured, clean, dry and free of efflorescence, oil or other contaminants that would impair adhesion.
  2. Apply polymer-modified base coat mixture in continuous layer approximately 1/16 -1/8 inch thick.
  3. Apply a layer of Reinforcing Mesh into the wet mixture and trowel smooth until mesh is fully embedded. Lap adjoining pieces of mesh 2-1/2 inches minimum and as described in the manufacturer's written instructions and technical bulletins.
  4. Cure for a minimum of 24 hours, until dry, or longer as required by weather conditions.
- G. Primer Application:
1. Ensure that the surface of the wall is cured, clean, dry and free of efflorescence, oil or other contaminants that would impair adhesion.
  2. Primer color shall closely match that of the selected finish.
  3. Stir to a smooth homogeneous consistency and apply to the wall using a roller, brush or airless spray equipment. Refer to manufacturer's published data sheet for more complete instructions.
  4. Allow to completely dry.
- H. Finish Application:
1. Ensure that the surface of the wall is clean, dry and free of any contaminants that may impair the adhesion of surface finish.
  2. Spray or trowel apply textured finish to dried primer.
  3. Apply finish to natural breaks to avoid visible cold joints.
  4. Always work the shady side of the wall or provide temporary shading to avoid application in direct sunlight.
  5. Apply in accordance with manufacturer directions for the specific finish and texture being used.
- I. Concealed Exterior Plaster: Where plaster application is used as a base for adhered finishes, omit finish coat.
- J. Concealed Interior Plaster:
1. Where plaster application is concealed behind built-in cabinets, similar furnishings, and equipment, apply finish coat.
  2. Where plaster application is concealed above suspended ceilings and in similar locations, omit finish coat.
  3. Where tile or other finishes are adhered to plaster, verify that plaster work specified complies with requirements for setting materials.
  4. Where plaster application is used as a base for adhesive application of tile and similar finishes, omit finish coat.
- K. Adhered Veneer Cladding: Install as specified in related sections.
- L. Specialty Finishes: Install as specified in related sections.

**3.08 PLASTER REPAIRS**

- A. Repair or replace work to eliminate cracks, dents, blisters, buckles, crazing and check cracking, dry outs, efflorescence, sweat outs, and similar defects and where bond to substrate has failed.
- B. Remove and replace material that is stained, damaged or that does not match specified finishes. Provide new matching finish as specified, without evidence of replacement.

**3.09 CLEANING AND PROTECTION**

- A. Clean installed surfaces in accordance with manufacturer's instructions; do not clean surfaces with products not specified in manufacturer's instructions. Clean as work progresses, remove residue without delay.
- B. Protect metal surfaces and plumbing fixtures. Flush surfaces with clean water before and after cleaning.
- C. Protect finished work from damage until acceptance by Owner.

**END OF SECTION**

## SECTION 09 3000

### TILING

#### PART 1 GENERAL

##### 1.01 SECTION INCLUDES

- A. Tile: Ceramic, ceramic mosaic, and quarry tile for floor, wall, and interior applications.
- B. Cementitious backer board as tile substrate.
- C. Coated glass mat backer board as tile substrate.
- D. Ceramic trim.

##### 1.02 RELATED REQUIREMENTS

- A. Section 01 6116 - Volatile Organic Compound (VOC) Content Restrictions.
- B. Section 06 1000 - Rough Carpentry: Wood frame substrates.
- C. Section 08 3100 - Access Doors.
- D. Pertinent Sections specifying work penetrating tile surfaces.

##### 1.03 REFERENCE STANDARDS

- A. ANSI A108/A118/A136 - American National Standard Specifications for the Installation of Ceramic Tile (Compendium); 2017.
- B. Manufacturer's specifications and recommendations for mounting in exterior or wet areas.
- C. ASTM C1178/C1178M - Standard Specification for Coated Glass Mat Water-Resistant Gypsum Backing Panel; 2013.
- D. ASTM D4068 - Standard Specification for Chlorinated Polyethylene (CPE) Sheeting for Concealed Water-Containment Membrane; 2015.
- E. California Code of Regulations, Title 24, Part 2, California Building Code (CBC), International Building Code.
- F. California Code of Regulations, Title 24, Part 11 California Green Building Standards Code, "CAL-Green".
- G. Division of the State Architect Interpretation of Regulations (IR) 23-3: Approved Alternate for Toilet Room Curb, latest edition.
- H. TCNA (HB) - Handbook for Ceramic, Glass, and Stone Tile Installation; 2015.

##### 1.04 DEFINITIONS

- A. General: Definitions in the ANSI A108 series of tile installation standards and in ANSI A137.1 apply to Work of this Section unless otherwise specified.
  - 1. ANSI A108 Series: ANSI A108.01, ANSI A108.02, ANSI A108.1A, ANSI A108.1B, ANSI A108.1C, ANSI A108.4, ANSI A108.5, ANSI A108.6, ANSI A108.8, ANSI A108.9, ANSI A108.10, ANSI A108.11, ANSI A108.12, ANSI A108.13, ANSI A108.14, ANSI A108.15, ANSI A108.16, and ANSI A108.17, which are contained in its "Specifications for Installation of Ceramic Tile."
- B. Module Size: Actual tile size plus joint width indicated.
- C. Face Size: Actual tile size, excluding spacer lugs.
- D. Large Format Tile: Tile that is greater than 15 inches (381 mm) in width or length.

- E. Wet Area: Includes tile surfaces that are either soaked, saturated, or regularly and frequently subjected to moisture such as tub enclosures, showers, swimming pools, commercial kitchens and exterior areas.

#### 1.05 SUBMITTALS

- A. See Section 01 3300 - Submittal Procedures.
- B. Product Data: Provide manufacturers' data sheets on tile, mortar, grout, grout sealer and accessories. Include instructions for using grouts and adhesives.
  - 1. Identify additional requirements and areas where manufacturer's installation instructions differ from TCNA documents.
- C. CAL-GREEN Submittals:
  - 1. Product Data - VOC Limits: For adhesives, sealants, fillers, primers and coatings, documentation including printed statement of VOC contents, comply with limits specified in related section.
  - 2. Product Data - Low/No-VOC Paints, Coatings and Tile Sealers. Provide certification that all primers and coatings meet VOC emission limits specified in in related section. List manufacturer, brand, application, type (flat or non-flat), number of gallon, and the VOC emissions in grams/liter. Include MSDS and product data sheet indicating VOC limits for each product provided.
- D. Shop Drawings: Indicate tile layout, patterns, color arrangement, perimeter conditions, junctions with dissimilar materials, control and expansion joints, thresholds, ceramic accessories, and setting details.
- E. Samples for Selection:
  - 1. Two manufacturer color charts consisting of actual tiles or sections of tile showing full range of standard and custom colors, textures and patterns available for each type of tile indicated.
  - 2. Grout and accessories requiring color selection.
- F. Installation Instructions: Manufacturer's printed instructions for each product.
- G. Manufacturer's Certificate: Certify that products meet or exceed specified requirements.
- H. Maintenance Data: Include recommended cleaning methods, cleaning materials, and stain removal methods.
- I. Maintenance Materials: Furnish the following for Owner's use in maintenance of project.
  - 1. See Section 01 6000 - Product Requirements, for additional provisions.
  - 2. Extra Tile: 1 percent of each size, color, and surface finish combination, but not less than 10 square feet of each type.
  - 3. Leftover Materials: all leftover materials not installed.

#### 1.06 QUALITY ASSURANCE

- A. Maintain one copy of and ANSI A108/A118/A136 and TCNA (HB) on site.
- B. Manufacturer Qualifications: Company specializing in manufacturing the types of products specified in this section, with minimum five years of documented experience.
- C. Installer Qualifications:
  - 1. Company specializing in performing tile installation, with minimum of five years of documented experience.

#### 1.07 MOCK-UP

- A. See Section 01 4000 - Quality Control, for general requirements for mock-up.

- B. Construct tile mock-up in a mutually accepted location, incorporating all components specified for the location. Minimum size 8 feet long by full height of indicated tile extent.
- C. Approved mock-up may remain as part of the Work.

**1.08 DELIVERY, STORAGE, AND HANDLING**

- A. Deliver and store packaged materials in original containers with seals unbroken and labels intact until time of use. Prevent damage or contamination to materials by water, freezing, foreign matter or other causes.
  - 1. Provide heated and dry storage facilities on site.
- B. Package labeling in accordance with ANSI A137.1. Retain labels and packaging until disposal is authorized by Architect.
- C. Protect adhesives from freezing or overheating in accordance with manufacturer's instructions. Do not use frozen materials.
- D. Deliver and store materials on site at least 24 hours before work begins.

**1.09 FIELD CONDITIONS**

- A. Maintain environmental conditions and protect work during and after installation to comply with referenced standards and manufacturer's printed recommendations.

**PART 2 PRODUCTS**

**2.01 DESIGN REQUIREMENTS**

- A. VOC Limits for adhesives, sealants, fillers, primers and coatings . Comply with limits specified in related section.
- B. Slip Resistance: For tile installed on walking surfaces, stair treads and landings, provide products with the following values as determined by testing identical products per ANSI A137.1-2012, Section 9.6
  - 1. Method: Dynamic Coefficient of Friction DCOF AcuTest method, wet test using 0.05 percent sodium lauryl sulfate solution.
  - 2. Application: Level interior flooring surface
  - 3. Tested value: 0.42 or greater
- C. Expansion Joints: In accordance with EJ-171 of the Tile Installation Handbook. Provide at expansion joints in the backing materials, cold joints in concrete substrate or where backing materials change.
  - 1. Exterior Work and Interior Wet Locations: Provide on all surfaces maximum 12-feet on center in both axes.
  - 2. Interior Work, not otherwise specified: Provide on continuous floor areas at intervals of 24-feet.
- D. Wainscots: Make top course full uncut tile. Extend wainscot to higher elevation by adding horizontal courses of tile as required to completely surround access panels, switch or outlet covers with finished tile. Do not permit these items penetrating tile surfaces to split the boundary of the tile surface.

**2.02 TILE**

- A. General:
  - 1. Field and accent tiles shall be of the same caliper.
- B. Manufacturers: All products by the same manufacturer.
  - 1. Dal-Tile Corporation: [www.daltile.com/#sle](http://www.daltile.com/#sle).
  - 2. Substitutions: See Section 01 6000 - Product Requirements.

- C. Ceramic Mosaic Tile: ANSI A137.1, standard grade.
  - 1. Shape: As indicated in drawings.
  - 2. Edges: Square.
  - 3. Surface Finish: Unglazed.
  - 4. Color:
    - a. Field: As indicated in Drawings
    - b. Accent: As indicated in Drawings.
  - 5. Pattern: As indicated; if none indicated, allow for field and accent colors, (two colors) and request pattern.
  - 6. Trim Units: Matching bead, cove, and surface bullnose shapes in sizes coordinated with field tile.
  - 7. Products:
    - a. Daltile; Keystones™.
- D. Glazed Wall Tile: ANSI A137.1, standard grade.
  - 1. Moisture Absorption: 7.0 to 20.0 percent as tested in accordance with ASTM C373.
  - 2. Edges: Cushioned.
  - 3. Surface Finish: High gloss.
  - 4. Color: Field colors As scheduled
  - 5. Pattern: As indicated; if none indicated, allow for field and two accent colors (three colors) and request pattern.
  - 6. Trim Units: Matching bead, bullnose, cove, and base shapes in sizes coordinated with field tile.
- E. Glazed Wall Tile : ANSI A137.1, and as follows:
  - 1. Size: As indicated on drawings
  - 2. Thickness: 5/16 inch.
  - 3. Edges: Cushioned.
  - 4. Surface Finish: Glazed.
  - 5. Color: As indicated in drawings
  - 6. Pattern: As indicated in drawings
  - 7. Trim Units: Matching bead, bullnose, cove, and base shapes in sizes coordinated with field tile.
  - 8. Products:
    - a. Daltile; Semi-Gloss™ and Semi-Gloss™ Color Trends.
    - b. Substitutions: See Section 01 6000 - Product Requirements.

### **2.03 TRIM AND ACCESSORIES**

- A. Ceramic Trim: Matching bullnose, double bullnose, cove base, and cove ceramic shapes in sizes coordinated with field tile.
  - 1. Applications:
    - a. Open Edges: Bullnose.
    - b. Inside Corners: Coved.
    - c. Floor to Wall Joints: Cove base.
  - 2. Manufacturers: Same as for tile.

### **2.04 SETTING MATERIALS**

- A. Acceptable Manufacturers:
  - 1. Custom Building Products; 13001 Seal Beach Blvd., Seal Beach, CA 90740, (800) 272-8786  
John Gallup - (209) 518-1153 johng@cbpmail.net, www.custombuildingproducts.com
  - 2. LATICRETE International, Inc; www.laticrete.com.
  - 3. Mapei Corporation; www.mapei.com..
  - 4. Substitutions: See Section 01 6000 - Product Requirements.

- B. Source Limitations: Provide tile grout, setting materials, additives, and factory-prepared dry-set mortars and surface preparation materials, waterproofing and crack isolation membranes, and self-leveling underlayments from the same manufacturer.
- C. Latex-Portland Cement Mortar Bond Coat: 1, 1, or [\_\_\_\_].
  - 1. Applications: Use this type of bond coat where indicated and where no other type of bond coat is indicated.
  - 2. Products:
    - a. Custom Building Products; [www.custombuildingproducts.com](http://www.custombuildingproducts.com).
      - 1) Premium Plus Thin Set Mortar gauged with Thin-Set Mortar Additive.
      - 2) ProLite Lightweight Fortified Thin-Set Mortar, gauged with water only.
      - 3) MegaFlex Fortified ThinSet Mortar, gauged with water only.
    - b. LATICRETE International, Inc; LATICRETE 254 Platinum: [www.laticrete.com/#sle](http://www.laticrete.com/#sle).
    - c. Mapei; [www.mapei.com](http://www.mapei.com).
      - 1) Kerabond Thin-set Mortar gauged with Keralastic Latex Additive
      - 2) UltraFlex3 gauged with water only.
      - 3) Ultra Lite fortified thin-set mortar gauged with water only.
    - d. Substitutions: See Section 01 6000 - Product Requirements.
- D. Epoxy Adhesive and Mortar Bond Coat: ANSI A118.3.
  - 1. Applications: Where indicated on drawings and as required by TCNA methods specified.
  - 2. Products:
    - a. Custom Building Products; EBMLite - Lightweight Epoxy Bonding Mortar or CEGLite - Lightweight Commercial Epoxy Grout - Setting and Grouting Epoxy [www.custombuildingproducts.com](http://www.custombuildingproducts.com).
    - b. LATICRETE International, Inc; LATICRETE LATAPOXY 300 Adhesive: [www.laticrete.com/#sle](http://www.laticrete.com/#sle).
    - c. Substitutions: See Section 01 6000 - Product Requirements.
- E. Mortar Bed Materials: Pre-packaged mix of Portland cement, sand, latex additive, and water.
  - 1. Products:
    - a. Custom Building Products; Thick Bed Bedding Mortar: [www.custombuildingproducts.com](http://www.custombuildingproducts.com).
    - b. LATICRETE International, Inc; LATICRETE 3701 Fortified Mortar Bed: [www.laticrete.com/#sle](http://www.laticrete.com/#sle).
    - c. Mapei; 4 To 1 Mud Bed Mix: [www.mapei.com](http://www.mapei.com).
    - d. Substitutions: See Section 01 6000 - Product Requirements.

## 2.05 GROUTS

- A. Manufacturers:
  - 1. Custom Building Products: [www.custombuildingproducts.com](http://www.custombuildingproducts.com)
  - 2. LATICRETE International, Inc; LATICRETE PERMACOLOR Grout: [www.laticrete.com/#sle](http://www.laticrete.com/#sle).
  - 3. Mapei Corporation: [www.mapei.com](http://www.mapei.com).
  - 4. Substitutions: See Section 01 6000 - Product Requirements.
- B. Epoxy Grout: ANSI A118.3 chemical resistant and water-cleanable epoxy grout with a VOC content of 65 g/L or less and a System Warranty of Twenty-Five Years.
  - 1. Applications: Where indicated.
  - 2. Color(s): As selected by Architect from manufacturer's full line.
  - 3. Products:
    - a. Custom Building Products; CEGLite Lightweight Commercial Epoxy Grout.



- b. LATICRETE International, Inc; LATICRETE SPECTRALOCK PRO Premium Grout:  
[www.laticrete.com/#sle](http://www.laticrete.com/#sle).
- c. Mapei; Kerapoxy.

## 2.06 MAINTENANCE MATERIALS

- A. Tile Sealant: Gunnable, silicone, siliconized acrylic, or urethane sealant; moisture and mildew resistant type.
  - 1. Applications: Between tile and plumbing fixtures.
  - 2. Color(s): As selected by Architect from manufacturer's full line.
  - 3. Products:
    - a. LATICRETE International, Inc; LATICRETE LATASIL: [www.laticrete.com/#sle](http://www.laticrete.com/#sle).
    - b. Substitutions: See Section 01 6000 - Product Requirements.
- B. Grout Sealer: Liquid-applied, moisture and stain protection for existing or new Portland cement grout that does not change color or appearance of grout. Colorless, no-sheen, water-based penetrating slip and stain-resistant sealer, not affecting color or physical properties of surfaces as recommended by tile manufacturers..
  - 1. Composition: Water-based colorless silicone.
  - 2. Products:
    - a. Aqua Mix® Sealers Choice® Gold as manufactured by CUSTOM Building Products, [www.custombuildingproducts.com](http://www.custombuildingproducts.com)
    - b. DuPont™ StoneTech® Professional Impregnator Pro® Sealer as manufactured by Dupont, [www2.dupont.com](http://www2.dupont.com) as supplied by Laticrete, [www.laticrete.com](http://www.laticrete.com).
    - c. MAPEI Corporation, [www.mapei.com](http://www.mapei.com), Ultracare™ line of products.
    - d. Miracle, [www.miraclesealants.com](http://www.miraclesealants.com), Impregnator 511 (Original).
    - e. Substitutions: See Section 01 6000 - Product Requirements.

## 2.07 ACCESSORY MATERIALS

- A. Waterproofing Membrane at Floors: Specifically designed for bonding to cementitious substrate under thick mortar bed or thin-set tile; complying with ANSI A118.10.
  - 1. Fluid or Trowel Applied Type:
    - a. Material: Synthetic rubber.
    - b. Thickness: 25 mils (0.6 mm), minimum, dry film thickness.
    - c. Products:
      - 1) Custom Building Products; RedGard Crack Prevention and Waterproofing Membrane: [www.custombuildingproducts.com/#sle](http://www.custombuildingproducts.com/#sle).
      - 2) LATICRETE International, Inc; LATICRETE HYDRO BAN: [www.laticrete.com/#sle](http://www.laticrete.com/#sle).
      - 3) Substitutions: See Section 01 6000 - Product Requirements.
- B. Waterproofing Membrane at Showers and Tiled Tubs: Specifically designed for bonding to cementitious substrate under thick mortar bed or thin-set tile; complying with ANSI A118.10.
  - 1. Fluid or Trowel Applied Type:
    - a. Material: Synthetic rubber.
    - b. Thickness: 25 mils (0.6 mm), minimum, dry film thickness.
    - c. Products:
      - 1) Custom Building Products; Redgard Crack Prevention and Waterproofing Membrane: [www.custombuildingproducts.com](http://www.custombuildingproducts.com).
      - 2) LATICRETE International, Inc; LATICRETE HYDRO BAN: [www.laticrete.com/#sle](http://www.laticrete.com/#sle).
      - 3) Substitutions: See Section 01 6000 - Product Requirements.
- C. Waterproofing Membrane Under Thick Mortar Bed at Showers and Tiled Tubs:

1. Material: Chlorinated polyethylene sheet, 40 mils (1.0 mm) thick, minimum; complying with ASTM D4068.
2. Products:
  - a. Noble Company; Chloraloy Shower Pan Liner: [www.noblecompany.com/#sle](http://www.noblecompany.com/#sle).
  - b. Substitutions: See Section 01 6000 - Product Requirements.
- D. Cleavage Membrane Under Thick Mortar Bed:
  1. Material: No. 15 (6.9 kg) asphalt saturated felt.
- E. Reinforcing Mesh: 2 by 2 inch (51 by 51 mm) size weave of 16/16 wire size; welded fabric, galvanized.
- F. Membrane at Walls:
  1. Material: 4 mil (0.1 mm) thick polyethylene film.
- G. Underlayment at Floors: Specifically designed for bonding to thin-set setting mortar; not primarily a waterproofing material and having the following characteristics:
  1. Crack Resistance: No failure at 1/16 inch (1.6 mm) gap, minimum; comply with ANSI A118.12.
  2. Uncoupling Function: Allow for separation between membrane and the mortar adhering tile to the membrane when subjected to excessive substrate movement.
  3. Suitable for installation over green concrete.
  4. Suitable for installation over wood-based substrates.
  5. Type: Fluid or Trowel Applied.
    - a. Products:
      - 1) Custom Building Products; Redgard Crack Prevention and Waterproofing Membrane: [www.custombuildingproducts.com](http://www.custombuildingproducts.com).
      - 2) LATICRETE International, Inc; LATICRETE 125 Sound and Crack Adhesive: [www.laticrete.com/#sle](http://www.laticrete.com/#sle).
      - 3) Substitutions: See Section 01 6000 - Product Requirements.
- H. Backer Board: Cementitious type complying with ANSI A118.9; high density, glass fiber reinforced, 1/2 inch (12.7 mm) thick; 2 inch (51 mm) wide coated glass fiber tape for joints and corners.
- I. Backer Board: Coated glass mat type complying with ASTM C1178/C1178M; inorganic fiberglass mat on both surfaces and integral acrylic coating vapor retarder.
- J. Mesh Tape: 2 inch (50 mm) wide self-adhesive fiberglass mesh tape.
- K. Cleaning solutions
  1. Glazed tile: Acid or pH-neutral solutions as approved by the grout and tile manufacturers.
  2. Unglazed Tile: Clean with pH-neutral solutions.
- L. Tile Polish: As recommend by tile and grout manufacturers.

## **2.08 MIXES**

- A. Proportion and mix materials in accordance with manufacturer's instructions and applicable ANSI standards.

## **PART 3 EXECUTION**

### **3.01 EXAMINATION**

- A. Examine, with installer present, surfaces to receive tile work and conditions under which tile will be installed. Do not proceed with tile work until surfaces and conditions comply with requirements indicated in referenced tile installation standards and manufacturer's printed

instructions. Prepared substrates to be in accordance with ANSI A108, A3.1 and Tile Council of North America (TCNA) recommendations.

- B. Verify that sub-floor surfaces are smooth and flat within the tolerances specified for that type of work and are ready to receive tile.
- C. Verify that wall surfaces are smooth and flat within the tolerances specified for that type of work, are dust-free, and are ready to receive tile.
- D. Verify that sub-floor surfaces are dust-free and free of substances that could impair bonding of setting materials to sub-floor surfaces.
- E. Verify that required floor-mounted utilities are in correct location.

### **3.02 PREPARATION**

- A. Protect surrounding work from damage.
- B. Vacuum clean surfaces and damp clean.
- C. Seal substrate surface cracks with filler. Level existing substrate surfaces to acceptable flatness tolerances. Shim wood framingsubstrates to acceptable flatness tolerances.
- D. Install backer board in accordance with ANSI A108.11 and board manufacturer's instructions. Tape joints and corners, cover with skim coat of setting material to a feather edge.
- E. Blend tile before installation and ensure that variations are uniform in each location.

### **3.03 INSTALLATION - GENERAL**

- A. Install tile and thresholds and grout in accordance with applicable requirements of ANSI A108.1 through A108.13, manufacturer's instructions, and TCNA Handbook recommendations.
- B. Lay tile to pattern indicated. Do not interrupt tile pattern through openings.
  - 1. Align joints when adjoining tile on floor, base, walls and trim are same size.
  - 2. Layout tile work and center tile fields in both directions in each space or on each wall area.
  - 3. Provide minimum 1/2 tile at field edges.
  - 4. Adjust to minimize tile cutting. Provide uniform joint widths.
- C. Place thresholds at exposed tile edges.
- D. Cut and fit tile to penetrations through tile, leaving sealant joint space. Form corners and bases neatly. Align floor joints.
- E. Place tile joints uniform in width, subject to variance in tolerance allowed in tile size. Make grout joints without voids, cracks, excess mortar or excess grout, or too little grout.
- F. Extend tile work into recesses and under or behind equipment and fixtures, to form a complete covering without interruptions. Terminate work neatly at obstructions, edges and corners without disrupting pattern or joint alignments.
- G. Form internal angles square and external angles bullnosed.
- H. Accurately form intersections and returns.
  - 1. Perform cutting and drilling of tile without marring visible surfaces.
  - 2. Carefully grind cut edges of tile abutting trim, finish or built-in items to produce straight aligned joints.
  - 3. Fit tile closely to electrical outlets, piping, fixtures and other penetrations so that plates, collars, or covers overlap tile.

4. Terminate tile at center line of doors, unless otherwise indicated.
  5. Ensure that joints are symmetrical and that tile surfaces are plumb, true to line, and parallel to the room axis
- I. Sound tile after setting. Replace hollow sounding units.
  - J. Install expansion and control joints in accordance with TCNA method EJ171.
  - K. Keep control and expansion joints free of mortar, grout, and adhesive.
  - L. In areas with floor drains, maintain design floor elevation at walls; slope surfaces uniformly to drains at 1/8 inch per foot nominal without retention of water or ponding.
  - M. Prior to grouting, allow installation to completely cure; minimum of 48 hours.
  - N. Grout tile joints. Conform to requirements of ANSI A108.10.
  - O. At changes in plane and tile-to-tile control joints, use tile sealant instead of grout, with either bond breaker tape or backer rod as appropriate to prevent three-sided bonding.
  - P. Apply sealant to junction of tile and dissimilar materials and junction of dissimilar planes.
    1. Seal joint between wainscots and fixtures; seal around pipes penetrating wainscots. Tool exposed sealant joints to a uniformly smooth surface without laps, sags or depressions.
  - Q. Grout Sealing: Test sealer before application and assure that sealer will not stain grout.
    1. Test sealer before application and assure that sealer will not stain grout.
    2. Seal joints between wainscots and fixtures, seal around pipes penetrating wainscots.
    3. Tool exposed sealant joints to uniform smooth surface without laps, sags or depressions.
  - R. Cracked, split, chipped, misaligned or broken tiles will not be accepted in finished work.

#### **3.04 INSTALLATION - FLOORS - THIN-SET METHODS**

- A. Over interior concrete substrates, install in accordance with TCNA (HB) Method F113, dry-set or latex-Portland cement bond coat, with standard grout, unless otherwise indicated.
- B. Quarry Tile over interior concrete substrates, install in accordance with TCNA Handbook Method F115, with epoxy grout.
- C. Install tile-to-tile floor movement joints in accordance with TCNA (HB) Method EJ171F.

#### **3.05 INSTALLATION - FLOORS - MORTAR BED METHODS**

- A. Over interior concrete substrates, install in accordance with TCNA Handbook Method F112, bonded .
  1. Where waterproofing membrane is indicated, with standard grout or no mention of grout type, install in accordance with TCNA Handbook Method F121.
  2. Where epoxy bond coat and grout are indicated, install in accordance with TCNA Handbook Method F132, bonded.
- B. Cleavage Membrane: Seal joints and penetrations, Lap edges and ends.
- C. Mortar Bed Thickness: 5/8 inch (15.9 mm), unless otherwise indicated.

#### **3.06 INSTALLATION - WALL TILE**

- A. Over cementitious backer units on studs, install in accordance with TCNA Handbook Method W244C, using membrane at toilet rooms.
- B. Over coated glass mat backer board on studs, install in accordance with TCNA Handbook Method W245, using membrane at toilet rooms.

- C. Over interior concrete and masonry install in accordance with TCNA (HB) Method W211, bonded mortar bed without membrane.

### 3.07 GROUTING

- A. Grout joints in accordance with manufacturer's instructions and ANSI A108.10.
- B. Clean sanding water, dust, and foreign substances from joints to be grouted.
- C. Clean and dry tile surfaces.
- D. After grouting, remove all grout residue promptly.

### 3.08 TOLERANCES

- A. Variation from Plumb: For vertical joints, external corners, and other conspicuous lines, do not exceed 1/8 inch in 10 feet.
- B. Variation in Level: For horizontal joints and other conspicuous lines, do not exceed 1/4 inch in 20 feet (6 mm in 6 m), or 1/2 -inch (12 mm) maximum.
- C. Maximum Variation of Surface Flatness For Tile Floors: 1/8 inch in ten feet, non-cumulative, free of ponding, all water flows to drains.
- D. Maximum Variation of Surface Flatness For Tile Walls: 1/8 inch in ten feet, non-cumulative.
- E. Variation in Plane between Adjacent Units (Lipping): Do not exceed the following differences between faces of adjacent units as measured from a straightedge parallel to stone tiled surface:
  - 1. Units with Polished Faces: 1/64 -inch (0.4 mm).
  - 2. Units with Honed Faces: 1/32 -inch (0.8 mm).
  - 3. Units with Sand-Rubbed Faces: 1/32 -inch (0.8 mm).
  - 4. Units with Thermal-Finished Faces: Depth of thermal finish or 3/16 -inch (5 mm), whichever is less.
  - 5. Units with Natural-Cleft Faces: Depth of natural-cleft finish or 3/16 -inch (5 mm), whichever is less.
- F. Variation in Joint Width: Do not vary joint thickness more than 1/16 -inch (1.6 mm) or one-fourth of nominal joint width, whichever is less.
- G. Correct surfaces if tolerances are not as specified.
- H. Correct defects by removal and replacement of the defective work. Areas requiring corrective work will be identified. Re-measure corrected areas for compliance.

### 3.09 ADJUSTING AND CLEANING

- A. Remove and replace tile that is damaged or that does not match adjoining tile. Provide new matching units, installed as specified and in a manner to eliminate evidence of replacement.
- B. Allow grout to cure 14 days before cleaning. Clean all ceramic tile surfaces so they are free of foreign matter. Flush surface with clean water before and after cleaning.
- C. Clean tile and grout surfaces.
- D. Protect metal surfaces, cast iron and vitreous plumbing fixtures from effects of acid cleaning.
- E. Before final inspection, remove protective coverings and rinse neutral cleaner from tile surfaces.

### **3.10 PROTECTION**

- A. Do not permit traffic over finished floor surface for 7 days after installation.
- B. Floors: Protect from all traffic for at least 72 hours after installation.
  - 1. Do not step on floor for at least 24 hours; if traffic is unavoidable after that, use plywood stepping boards.
  - 2. Protect from heavy traffic for at least 7 days after installation.
  - 3. When fast-setting materials are used to allow faster occupancy, comply with the manufacturer's recommendations.
  - 4. Protect installed tile work with kraft paper or other heavy covering during construction period to prevent staining, damage and wear.
- C. Walls: Protect from impact, vibration and heavy hammering on adjacent and opposite walls for at least 14 days after installation, unless manufacturer's instructions allow a shorter period.
- D. Protect from food products and chemicals which can cause staining for at least 14 days.
- E. Protect from freezing and total water immersion for at least 21 days after installation.

**END OF SECTION**

**SECTION 09 5100**  
**ACOUSTICAL CEILINGS**

**PART 1 GENERAL**

**1.01 SECTION INCLUDES**

- A. Suspended metal grid ceiling systems, seismically restrained.
- B. Acoustical units.

**1.02 RELATED REQUIREMENTS**

- A. Section 01 6116 - Volatile Organic Compound (VOC) Content Restrictions.
- B. Section 01 8113 - Sustainable Design Requirements.
- C. Section 07 2100 - BOARD AND BATT BUILDING INSULATION: Acoustical insulation.
- D. Section 08 3100 - Access Doors and Panels: Access panels.
- E. Division 21: Pertinent sections specifying fire suppression work above and in ceilings.
- F. Division 23: Pertinent sections specifying mechanical work above and in ceilings.
- G. Division 26: Pertinent sections specifying electrical work above and in ceilings.
- H. Division 27 and 28: Pertinent sections specifying signal and fire alarm work above and in ceilings.

**1.03 REFERENCE STANDARDS**

- A. ASTM C635/C635M - Standard Specification for the Manufacture, Performance, and Testing of Metal Suspension Systems for Acoustical Tile and Lay-in Panel Ceilings; 2013a.
- B. ASTM C636/C636M - Standard Practice for Installation of Metal Ceiling Suspension Systems for Acoustical Tile and Lay-In Panels; 2013.
- C. ASTM E580/E580M - Standard Practice for Installation of Ceiling Suspension Systems for Acoustical Tile and Lay-in Panels in Areas Subject to Earthquake Ground Motions; 2014.
- D. ASTM E1264 - Standard Classification for Acoustical Ceiling Products; 2014.
- E. CHPS (HPPD) - High Performance Products Database; Current Edition at [www.chps.net/](http://www.chps.net/).
- F. CISCA (Ceilings and Interior Systems Contractors Association) - Acoustical Ceilings: Use and Practice.
- G. UL (FRD) - Fire Resistance Directory; current edition.
- H. California Code of Regulations, Title 24, Part 11, California Green Building Standards Code, "CAL-Green".
- I. California Building Code (CBC), Title 24, Part 2, Section 1616A.
- J. Division of the State Architect (DSA) Interpretation of Regulations (IR) 25-2.13: Metal Suspension Systems for Lay-In Panel Ceilings, revised 02-10-16
- K. ASCE 7-05, Minimum Design Loads for Buildings and Other Structures, American Society for Civil Engineers

#### **1.04 ADMINISTRATIVE REQUIREMENTS**

- A. Sequence work to ensure acoustical ceilings are not installed until building is enclosed, sufficient heat is provided, dust generating activities have terminated, and overhead work is completed, tested, and approved.
- B. Do not install acoustical units until after interior wet work is dry.

#### **1.05 SUBMITTALS**

- A. See Section 01 3300 - Submittals, for submittal procedures.
- B. Provide complete submittals at the same time as submittals for work in related sections to permit review of complete and integrated systems and assemblies.
- C. Shop Drawings: Indicate grid layout and related dimensioning, junctions with other ceiling finishes, mechanical and electrical items installed in the ceiling, and locations and spacing of seismic restraint elements.
- D. Product Data: Provide data on suspension system components and acoustical units.
- E. CAL-GREEN Submittals: Product Data – VOC Limits: For adhesives sealants, fillers, primers and coatings, documentation including printed statement of VOC contents, comply with limits specified in related section.
- F. Samples: Submit two samples 6 x 6 inch in size illustrating each type and finish of acoustical units, and two samples 12 inches long of each type and finish of suspension system main runner.
- G. Manufacturer's Installation Instructions: Indicate special procedures and perimeter conditions requiring special attention.
- H. Maintenance Materials: Furnish the following for Owner's use in maintenance of project.
  - 1. See Section 01 6000 - Product Requirements, for additional provisions.
  - 2. Extra Acoustical Units: Quantity equal to 5 percent of total installed.
- I. Manufacturer's recommendations for cleaning and refinishing acoustical units and suspension system, including precautions against materials and methods detrimental to finishes and acoustical performances.

#### **1.06 QUALITY ASSURANCE**

- A. Conform to CISCA requirements.
- B. Requirements of regulatory agencies: Conform to governing codes and regulations. All materials shall be UL tested, listed and labeled.
- C. Suspension System Manufacturer Qualifications: Company specializing in manufacturing the products specified in this section with minimum three years documented experience.
- D. Acoustical Unit Manufacturer Qualifications: Company specializing in manufacturing the products specified in this section with minimum three years documented experience.

#### **1.07 PROJECT CONDITIONS**

- A. Before installation acoustical material, ensure that temperature and humidity conditions approximate interior conditions to exist when room is occupied. Maintain this conditions during and after installation.



- B. Maintain uniform temperature of minimum 60 degrees F (16 degrees C), and maximum humidity of 70 percent prior to, during, and after acoustical unit installation.
- C. Sequence work to ensure acoustical ceilings are not installed until building is enclosed, sufficient heat is provided, dust generating activities have terminated, and overhead work is completed, tested, and approved.
- D. Install acoustical units after interior wet work, including painting and coating, is dry.
- E. Protect completed work above suspension system from damage during installation of suspension system components.

#### 1.08 EXTRA MATERIALS

- A. See Section 01 7000 - Contract Closeout for additional provisions.
- B. Provide 96 sq ft (\_\_\_\_ sq m) (12 count) 24" x 48") of each type of acoustical unit for Owner 's use in maintenance of project.
- C. Provide equivalent area of wood grille panels and acoustic infill accessories.

### PART 2 PRODUCTS

#### 2.01 PERFORMANCE REQUIREMENTS

- A. Design Load Requirements:
  - 1. Hangers and Connections: Capable of carrying at least five times design load indicated in ASTM C 635; and minimum of 100 pounds.
  - 2. Ultimate strength of connections in tension of at least 280 pounds or twice actual load whichever is greater.
- B. Installed System: Comply with all requirements of DSA IR 25.2-13.
  - 1. Grid System to be Heavy Duty Rated as defined by ASTM C635.
  - 2. Meet requirements of Seismic Zone Categories D, E, and F for ASTM C636 and ASTM E580.
- C. VOC Limits for adhesives, sealants, fillers, primers and coatings . Comply with limits specified in related section.
- D. Composite Wood products must meet current CARB Airborne Toxic Control Measure (ATCM) for Composite Wood Formaldehyde Limits by Mandatory Compliance Dates as specified in Section 01 6116.
- E. Grid: True plane and level within tolerances specified.
- F. Surface burning less than 25 in accordance with ASTM E 84.
- G. Insulating Material Standards: All insulation materials must comply with the California Referenced Standards Code, California Code of Regulations, Title 24, Part 12 / Chapter 12-13 Standards for Insulating Material.

#### 2.02 MANUFACTURERS

- A. Acoustic Tiles/Panels:
  - 1. Armstrong World Industries, Inc: [www.armstrong.com/#sle](http://www.armstrong.com/#sle).
  - 2. Substitutions: See Section 01 6000 - Product Requirements.
- B. Suspension Systems:
  - 1. Same as for acoustical units.

### 2.03 ACOUSTICAL UNITS

- A. Acoustical Units - General: ASTM E1264, Class A.
  - 1. VOC Content: As specified in Section 01 6116.
  - 2. VOC Content: Certified as Low Emission by one of the following:
    - a. Product listing in CHPS (HPPD).
- B. Acoustical Tile Type Calla Tegular: Wet-formed mineral fiber, with acoustically transparent membrane with the following characteristics:
  - 1. ASTM E162 Classification, Type IV, Form 2, Pattern E.
  - 2. Fire Class A.
  - 3. Humidity / Sag Resistant.
  - 4. Mold / Mildrew Protection: Bio-Block/
  - 5. GreenGuard Gold Certified.
  - 6. >50% recycled content.
  - 7. Sizes as indicated on the Drawings.
  - 8. Thickness: 1 inch.
  - 9. Light Reflectance: 0.85 percent, determined in accordance with ASTM E1264.
  - 10. NRC Range: 0.85 to 0.85, determined in accordance with ASTM E1264.
  - 11. Ceiling Attenuation Class (CAC): 35, determined in accordance with ASTM E1264.
  - 12. Edge: Square tegular.
  - 13. Surface Color: To be selected by Architect from manufacturer's standard line.
  - 14. Surface Pattern: Smooth.
  - 15. Products:
    - a. Armstrong Calla Square Tegular Panels.
    - b. Substitutions: See Section 01 6000 - Product Requirements.
- C. Acoustical Panels: Painted mineral fiber, ASTM E1264 Type III, with the following characteristics:
  - 1. Size: 12 by 24 inches (300 by 600 mm).
  - 2. Fire Hazard Classification: Class A (Flame spread 25 Smoke Developed 25 or under), UL Labeled, meeting ASTM E 1264 and E 84.
  - 3. Edge: Square.
  - 4. Surface Color: White.
  - 5. Surface Pattern: Non-directional fissured.
  - 6. Product: Cortega 769 by Armstrong, "Radar" by USG.
- D. Acoustical Panels Type 2: Painted mineral fiber, conforming to the following:
  - 1. Size: 24 x 24 inches (600 x 600 mm).
  - 2. Thickness: 3/4 inches (19 mm).
  - 3. Fire Hazard Classification: Class A (Flame spread 25 Smoke Developed 25 or under), UL Labeled, meeting ASTM E 1264 and E 84.
  - 4. Panel Edge: Type "FL Fineline".
  - 5. Surface Pattern: Non-directional fine textured appearance.
  - 6. Surface Color: Color as selected from manufacturer's standards.
  - 7. Product: "Eclipse" by U.S. Gypsum.
- E. Acoustical Panels Type Kitchen Zone: Wet-formed mineral fiber with factory-applied latex paint, listed and approved by USDA and FDA for use in food service areas and conforming to the following:
  - 1. ASTM E1264 Classification: Type IX, Form 2, Pattern G.
  - 2. Fire Class A.
  - 3. Humidity / Sag Resistance.

4. Mold /Mildew Protection: Bio-Guard.
5. GreenGuard Certified.
6. Size: As indicated on Drawings.
7. Thickness: 5/8 inch.
8. Light Reflectance: 0.89 percent.
9. NRC Range: NA to NA.
10. CAC: 33 to 33.
11. Edge: Square.
12. Surface Color: White.
13. Surface Pattern: smooth.
14. Product: Kitchen Zone by Armstrong.

#### **2.04 SUSPENSION SYSTEM(S)**

- A. Suspension Systems - General: ASTM C635; die cut and interlocking components, with stabilizer bars, clips, splices, perimeter moldings, and seismic clips as required. Pull-out tension values greater than 300 lbs
- B. Exposed Steel Suspension System: Formed steel, commercial quality cold rolled; heavy-duty.
- C. Factory Finish: Painted, color as selected. Multiple colors will be required.
- D. Profile: Tee; 15/16 inch (24 mm) wide face.
  1. Construction: Double web.
  2. Product: Prelude XL by Armstrong. ICC-ESR-1308
    - a. Main Runner: 7301.
    - b. Cross Runner: XL7340.
    - c. Seismic Clip: MB with ESR4 expansion sleeve.
    - d. Wall Clip: BERC2
  3. Product: Seismic 1200 by Chicago Metallic ICC-ESR-2282 (Seismic Clip) & ICC-ESR-2631
    - a. Main Runner: 200.
    - b. Cross Runner: 1214.
    - c. Seismic Clip: SST.
    - d. Wall Clip: 1496
  4. Product: "DX 26" Heavy Duty by U. S. Gypsum. ICC-ESR-1222
    - a. Main Runner: DX24.
    - b. Cross Runner: DX424.
    - c. Seismic Clip: ACM7.
    - d. Wall Clip ACM7
- E. Profile: Tee; 9/16 inch (14 mm) wide face.
  1. Construction: Double web.
  2. Product: Suprafine XL by Armstrong. ICC-ESR-1308
    - a. Main Runner: 7301.
    - b. Cross Runner: XL7340.
    - c. Seismic Clip: MB with ESR4 expansion sleeve.
    - d. Wall Clip: BERC2

#### **2.05 FINISHES**

- A. Acoustic Unit and Suspension System Color(s) as selected by Architect from:
  1. Manufacturer's full range of standard colors.

- B. Multiple color selections will be required as shown on the Drawings. If none are shown, request from the Architect.

## **2.06 ACCESSORIES**

- A. Support Channels and Hangers, stabilizer bars, clips, splices: Galvanized steel; size and type to suit application, seismic requirements, and ceiling system flatness requirement specified.
- B. Perimeter Moldings: Same metal and finish as grid.
  - 1. Size: As required for installation conditions and specified Seismic Design Category.
  - 2. Angle Molding: L-shaped, for mounting at same elevation as face of grid.
  - 3. Acoustical Sealant For Perimeter Moldings: Non-hardening, non-skinning, for use in conjunction with suspended ceiling system.
  - 4. At Exposed Grid: Provide L-shaped molding for mounting at same elevation as face of grid.
- C. Ceiling Suspension Wire: Class 1 zinc coated (galvanized) carbon steel conforming to ASTM A641-09a, #12 gage (0.106 inch diameter) with soft temper and minimum tensile strength = 70 ksi.
- D. Galvanized Sheet Steel (including that used for metal stud and track compression struts/posts): ASTM A653-11, or other equivalent sheet steel listed in Section A2.1 of the North American Specification for the Design of Cold-Formed Steel Structural Members 2007, including supplement 2 dated 2010 (AISI S100-07/S2-10).
  - 1. Material 43 mil (18 gage) and lighter: minimum yield strength of 33 ksi.
  - 2. Material 54 mil (16 gage) and heavier: minimum yield strength of 50 ksi.
- E. Electrical Metallic Tube (EMT): ANSI C80.3/UL 797 carbon steel with G90 galvanizing; minimum yield strength (Fy) of 30 ksi and minimum ultimate strength (Fu) of 48 ksi.
- F. Sheet Metal Screws: ASTM C1513-10, ASME B18.6.4-89 (R2005). Length as required so that penetration of screws through joined material shall not be less than three exposed threads.
- G. Acoustical Sealant For Perimeter Moldings: Non-hardening, non-skinning, for use in conjunction with suspended ceiling system., type recommended by ceiling manufacturer and complying with requirements of Section 07 9200.
- H. Gasket For Perimeter Moldings: Closed cell rubber sponge tape.
- I. Touch-up Paint: Type and color to match acoustical and grid units.

## **PART 3 EXECUTION**

### **3.01 EXAMINATION**

- A. Verify existing conditions before starting work.
- B. Verify that layout of hangers will not interfere with other work.

### **3.02 INSTALLATION - SUSPENSION SYSTEM**

- A. Install suspension system in accordance with ASTM C636/C636M, ASTM E580/E580M, and manufacturer's instructions and as supplemented in this section.
  - 1. Install suspension system as required by California Code of Regulations Chapter 1616A.1.21, DSA IR(s), and as supplemented in this section.
- B. Rigidly secure system, including integral mechanical and electrical components, for maximum deflection of 1:360.

- C. Locate system on room axis according to reflected plan.
- D. Coordinate layout with lighting fixtures, air outlets, partitions and other adjoining work.
- E. In exitways install with a main runner or cross-runner surrounding all sides of each ceiling unit and each light fixture or grille.
- F. Provide expansion joints at intersections and junctions of corridors, lobbies and other similar areas.
- G. Attach surface mounted fixtures to the main runner with at least two positive clamping devices composed of minimum 14 gauge steel. Rotational spring catches do not comply.
- H. Locate concrete reinforcement and prestressing tendons by non-destructive means prior to installing post - installed anchors. Do not damage reinforcing or tendons by anchor placement.
- I. Welding: In accordance with AWS D1.3 using E60XX series electrodes.
- J. Seismic Restraints: install in accordance with ASTM E 580, referenced standards and governing codes.
- K. Install after major above-ceiling work is complete. Coordinate the location of hangers with other work.
- L. Provide hanger clips during steel deck erection. Provide additional hangers and inserts as required.
- M. Hang suspension system independent of walls, columns, ducts, pipes and conduit. Where carrying members are spliced, avoid visible displacement of face plane of adjacent members.
- N. Where ducts or other equipment prevent the regular spacing of hangers, reinforce the nearest affected hangers and related carrying channels to span the extra distance.
- O. Do not eccentrically load system or induce rotation of runners.
- P. Form expansion joints as detailed. Accommodate plus or minus movement as indicated and to conform to referenced requirements. Maintain visual closure.

**3.03 FACILITY SERVICES WITHIN THE CEILING:**

- A. Positively attach all flexible sprinkler hose fitting mounting brackets, ceiling-mounted air terminals, light fixtures, and other similar facility service items to the ceiling suspension systems by means of screws or approved fasteners with a minimum of two attachments required at each component.
- B. Provide #12 gage slack safety wire (s) attached from the service item to the structure above to each item as described below:
  - 1. Items weighing less than or equal to 20 lb. shall have one (1) safety wire.
  - 2. Items weighing more than 20 lb. but less than or equal to 56 lb. shall have two (2) safety wires (at diagonal corners).
  - 3. Items weighing more than 56 lb. shall be supported directly from the structure above by not less than four (4) taut #12 gage hanger wires or other approved hangers attached from the item to the structure above.
- C. Miscellaneous Devices: Attach all lightweight miscellaneous devices, such as strobe lights, occupancy sensors, speakers, exit signs, video cameras, etc., to the ceiling grid.

1. For Devices weighing more than 10 lbs., provide #12 gage slack safety wire anchored to the structure above.
2. For Devices weighing more than 20 lb., provide support independently from the structure above.

### **3.04 INSTALLATION - ACOUSTICAL UNITS**

- A. Install acoustical units in accordance with manufacturer's instructions.
- B. Fit acoustical units in place, free from damaged edges or other defects detrimental to appearance and function.
- C. Fit border trim neatly against abutting surfaces.
- D. Install units after above-ceiling work is complete.
- E. Install acoustical units level, in uniform plane, and free from twist, warp, and dents.
- F. Cutting Acoustical Units:
  1. Cut to fit irregular grid and perimeter edge trim.
  2. Make field cut edges of same profile as factory edges.
  3. Double cut and field paint exposed reveal edges.
- G. Install inserted acoustic infill accessories into all wood grille units to match manufacturer details. Trim edges for secure fit without gaps or overlapping.

### **3.05 TOLERANCES**

- A. Maximum Variation from Flat and Level Surface: 1/8 inch in 10 feet (3 mm in 3 m).
- B. Maximum Variation from Plumb of Grid Members Caused by Eccentric Loads: 2 degrees.

### **3.06 TESTING**

- A. Perform all field testing in the presence of the project inspector.
- B. Post-Installed Anchors In Concrete: Field test power actuated fasteners for 200 lbs. in tension.
  1. Hanger Wire Anchors: Test at a frequency of 10 percent.
  2. Bracing Wire Anchors: Test at a frequency of 50 percent in accordance with CBC Section 1913A.7.
  3. All Other Post-Installed Anchors: Test in accordance with CBC Section 1913A.7.

### **3.07 CLEANING**

- A. Comply with requirements of Section 01 7000.
- B. Clean soiled surfaces in accordance with manufacturer's printed instructions. Remove and replace, with new materials, tiles and suspension systems that are damaged or cannot be acceptably cleaned to the Architect's satisfaction.
- C. Repainting exposed parts of suspension system shall be with a paint type and application method recommended for use over metal surfaces.
- D. Upon completion of the work, remove all materials, containers, equipment and debris. Leave area in a clean condition.

**END OF SECTION**

**SECTION 09 5133**  
**METAL ACOUSTICAL CEILINGS**

**PART 1 GENERAL**

**1.01 SECTION INCLUDES**

- A. Suspended metal grid ceiling systems, seismically restrained.
- B. Metal Faced Acoustical units.
- C. Accessories: Provide all other necessary items including devices for attachment to overhead construction, secondary members, splines, splices, connecting clips, wall connectors, wall angles, and all other devices required for a complete installation.

**1.02 RELATED REQUIREMENTS**

- A. Section 01 6116 - Volatile Organic Compound (VOC) Content Restrictions.
- B. Section 01 8113 - Sustainable Design Requirements.
- C. Section 08 3100 - Access Doors and Panels: Access panels.
- D. Division 21: Pertinent sections specifying fire suppression work above and in ceilings.
- E. Division 23: Pertinent sections specifying mechanical work above and in ceilings.
- F. Division 26: Pertinent sections specifying electrical work above and in ceilings.
- G. Division 27 and 28: Pertinent sections specifying signal and fire alarm work above and in ceilings.

**1.03 REFERENCE STANDARDS**

- A. ASTM C635/C635M - Standard Specification for the Manufacture, Performance, and Testing of Metal Suspension Systems for Acoustical Tile and Lay-in Panel Ceilings; 2013a.
- B. ASTM C636/C636M - Standard Practice for Installation of Metal Ceiling Suspension Systems for Acoustical Tile and Lay-In Panels; 2013.
- C. ASTM E580/E580M - Standard Practice for Installation of Ceiling Suspension Systems for Acoustical Tile and Lay-in Panels in Areas Subject to Earthquake Ground Motions; 2014.
- D. CISCA (Ceilings and Interior Systems Contractors Association) - Acoustical Ceilings: Use and Practice.
- E. UL (FRD) - Fire Resistance Directory; current edition.
- F. California Code of Regulations, Title 24, Part 11, California Green Building Standards Code, "CAL-Green".
- G. California Building Code (CBC), Title 24, Part 2, Section 1616A.
- H. Division of the State Architect (DSA) Interpretation of Regulations (IR) 25-2.13: Metal Suspension Systems for Lay-In Panel Ceilings, revised 02-10-16.
- I. ASCE 7-05, Minimum Design Loads for Buildings and Other Structures, American Society for Civil Engineers

**1.04 ADMINISTRATIVE REQUIREMENTS**

- A. Sequence work to ensure acoustical ceilings are not installed until building is enclosed, sufficient heat is provided, dust generating activities have terminated, and overhead work is completed, tested, and approved.

- B. Do not install acoustical units until after interior wet work is dry.

#### **1.05 SUBMITTALS**

- A. See Section 01 3300 - Submittals, for submittal procedures.
- B. Provide complete submittals at the same time as submittals for work in related sections to permit review of complete and integrated systems and assemblies.
- C. Shop Drawings: Indicate grid layout and related dimensioning, junctions with other ceiling finishes, mechanical and electrical items installed in the ceiling, and locations and spacing of seismic restraint elements.
- D. Product Data: Provide data on suspension system components and acoustical units.
- E. CAL-GREEN Submittals: Product Data – VOC Limits: For adhesives sealants, fillers, primers and coatings, documentation including printed statement of VOC contents, comply with limits specified in related section.
- F. Samples: Submit two samples 6 x 6 inch in size illustrating each type and finish of acoustical units, and two samples 12 inches long of each type and finish of suspension system main runner.
- G. Manufacturer's Installation Instructions: Indicate special procedures and perimeter conditions requiring special attention.
- H. Maintenance Materials: Furnish the following for Owner's use in maintenance of project.
  - 1. See Section 01 6000 - Product Requirements, for additional provisions.
  - 2. Extra Acoustical Units: Quantity equal to 5 percent of total installed.
- I. Manufacturer's recommendations for cleaning and refinishing acoustical units and suspension system, including precautions against materials and methods detrimental to finishes and acoustical performances.

#### **1.06 QUALITY ASSURANCE**

- A. Conform to CISCA requirements.
- B. Requirements of regulatory agencies: Conform to governing codes and regulations. All materials shall be UL tested, listed and labeled.
- C. Suspension System Manufacturer Qualifications: Company specializing in manufacturing the products specified in this section with minimum three years documented experience.
- D. Acoustical Unit Manufacturer Qualifications: Company specializing in manufacturing the products specified in this section with minimum three years documented experience.

#### **1.07 DELIVERY, STORAGE, AND HANDLING**

- A. Deliver acoustical metal ceiling units and suspension system components in original, unopened packages clearly labeled with the following information: name of manufacturing source and location; product type, description and quantity; clients name and shipping address.
- B. Panels' protective layer to be removed after installation is complete to help prevent panel surface damage.
- C. Store components in a fully enclosed space where they will be protected against physical damage from direct moisture, direct sunlight, surface contamination, and any other causes.



- D. Exercise care in handling components to prevent damage to the surfaces and edges and prevent distortion or other physical damage. Comply with prescribed stacking instructions to prevent damage to components

#### **1.08 PROJECT CONDITIONS**

- A. Before installation acoustical material, ensure that temperature and humidity conditions approximate interior conditions to exist when room is occupied. Maintain this conditions during and after installation.
- B. Maintain uniform temperature of minimum 60 degrees F (16 degrees C), and maximum humidity of 70 percent prior to, during, and after acoustical unit installation.
- C. Sequence work to ensure acoustical ceilings are not installed until building is enclosed, sufficient heat is provided, dust generating activities have terminated, and overhead work is completed, tested, and approved.
- D. Install acoustical units after interior wet work, including painting and coating, is dry.
- E. Protect completed work above suspension system from damage during installation of suspension system components.

#### **1.09 WARRANTY**

- A. Provide Manufacturers standard five year warranty against defects in materials or workmanship.

### **PART 2 PRODUCTS**

#### **2.01 PERFORMANCE REQUIREMENTS**

- A. Design Load Requirements:
  - 1. Hangers and Connections: Capable of carrying at least five times design load indicated in ASTM C 635; and minimum of 100 pounds.
  - 2. Ultimate strength of connections in tension of at least 280 pounds or twice actual load whichever is greater.
- B. Installed System: Comply with all requirements of DSA IR 25.2-13.
  - 1. Grid System to be Heavy Duty Rated as defined by ASTM C635.
  - 2. Meet requirements of Seismic Zone Categories D, E, and F for ASTM C636 and ASTM E580.
- C. VOC Limits for adhesives, sealants, fillers, primers and coatings . Comply with limits specified in related section.
- D. Fire-Test-Response Characteristics: Provide acoustical metal pan ceilings that comply with one of the following requirements:
  - 1. Fire-response tests performed by UL, ITS/Warnock Hersey, or another independent testing and inspecting agency that is acceptable to authorities having jurisdiction and that performs testing and follow-up services.
  - 2. Surface-burning characteristics of acoustical metal pan ceilings comply with ASTM E 1264 for Class A materials as determined by testing identical products per ASTM E 84.
- E. Composite Wood products must meet current CARB Airborne Toxic Control Measure (ATCM) for Composite Wood Formaldehyde Limits by Mandatory Compliance Dates as specified in Section 01 6116.
- F. Grid: True plane and level within tolerances specified.
- G. Surface burning less than 25 in accordance with ASTM E 84.

- H. Insulating Material Standards: All insulation materials must comply with the California Referenced Standards Code, California Code of Regulations, Title 24, Part 12 / Chapter 12-13 Standards for Insulating Material.

## 2.02 MANUFACTURERS

- A. Basis of Design: "Illusions" by Ceilings Plus - 6711 E. Washington Blvd., Los Angeles, CA 90040. 800-822-3411 - www.ceilingsplus.com. Contact: CADE Architectural Resources, E. Earl Carter, ecarter@caderesources.com, (415) 805-8584.
- B. Substitutions: See Section 01 6000 - Product Requirements.

## 2.03 ACOUSTICAL UNITS

- A. Ceiling Type MAC-1 - "Illusions" - Perforated - ### finish to match architects sample; or approved equal.
1. All panels are to be manufactured from single sheets of aluminum selected for surface flatness, smoothness and freedom from surface blemishes where exposed to view in a finished unit. Do not use material where the exposed surface exhibit pitting, seam marks, roller marks, stains, discolorations, or variations in flatness exceeding those permitted by referenced standards for stretcher-leveled aluminum alloy sheets.
  2. All panels are to be die formed with a minimum 1 ¼" integral return edge on all four panel sides. Steel clips that locate and align panels to the grid with torsion springs, are to be factory machine riveted to the return edge of the panels using counter sunk rivet holes that allow the flat heads of the counter sunk rivets to be flush the face of the panel return. No fasteners of any kind shall be visible on exposed face surfaces of ceiling panels or support tees. Down light openings and other ceiling penetrations shall be factory precision cut whenever viable.
  3. Panel material shall be primed aluminum sheet type 3105 (painted) / 5005 (anodized) series alloy that has a minimum 70% (50% @ 5005) recycled content. It shall be machine stretcher-leveled and a minimum of .032" thickness, or greater if required, so that the panel deflection does not exceed L/360.
  4. Panel Finish: One of the following, as selected by Architect
    - a. "Sarante" PVC free, faux wood veneer that is permanently bonded to the aluminum sheet with formaldehyde free, water based adhesive of minimum bond strength of 8 psi @ 25 degrees C.
    - b. "Arboreal" real wood veneer that is permanently bonded to the aluminum sheet with formaldehyde free, water based adhesive of minimum bond strength of 8 psi @ 25 degrees C.
    - c. Polyester "Painted" finish - 3105 alloy
    - d. Fluoropolymer "Painted" finish - 3105 alloy
    - e. "Anodized" finish - 5005 alloy
  5. Panel sizes as per architectural drawings. Field cut panels at non modular perimeter conditions, at column interfaces or as detailed or specified.
  6. Edge Profile: Panel joints are butt condition (concealed tee - as per ASTM A 1264) both directions (as per architectural drawings) unless specified otherwise.
  7. Perforation shall be (PARTí custom) (as selected by the architect from Ceilings Plus' standard patterns). Panels to have (full-bleed perforations) (solid non-perforated borders) along all sides.
  8. Sound-Absorptive Fabric Layer: Provide manufacturer's acoustic pads sized to fit concealed surface of panel. Material shall be both non-flammable and sound-absorptive.
    - a. Fire Class shall be Class-A, with surface-burning characteristics for flame-spread rating of 25 or less and smoke developed rating of 50 or less. Provide independent accredited lab test results showing compliance with Class-A rating as per ASTM E 84.

- b. Achieve absorption value of not less than .70 - .80 NRC. Provide independent accredited laboratory test results illustrating compliance with acoustical requirements as per ASTM C 423.
  - c. At all acoustical metal panel ceilings, provide recycled "Soundtex" nonwoven acoustical fleece in accordance with minimum NRC rating specified.
  - d. At all acoustical metal panel ceilings, provide recycled cotton "Ultrasorb" in sufficient thickness and density to attain minimum NRC rating specified.
9. The plenum shall be 100% accessible. Every panel must be removable. Progressive panel access is not acceptable. Heavy duty torsion springs and steel clip assemblies to be mounted to every panel for downward access, without potential for damage to panel face or hinge assembly. Hinge assembly shall be mounted to every panel with minimum two flush to face, counter sunk chamfered fasteners. Attaching torsion spring directly to panel with fastener will not be acceptable.
10. Fire Tests: Complete system test including suspension, primed aluminum and finish shall meet ASTM E84 Class A.
11. Provide and install matching finish trim on all sides of each suspended area (or as specified). Profile of trim to be minimum 4 ½" tall @ floating conditions or as detailed.

#### 2.04 SUSPENSION SYSTEM(S)

- A. Suspension Systems - General: ASTM C635; die cut and interlocking components, with stabilizer bars, clips, splices, perimeter moldings, and seismic clips as required. Pull-out tension values greater than 300 lbs.
- B. Exposed Steel Suspension System: Formed steel, commercial quality cold rolled; heavy-duty.
- C. Factory Finish: Painted, color as selected. Multiple colors will be required.

#### 2.05 METAL SUSPENSION SYSTEMS. GENERAL

- A. Metal Suspension System Standard: Provide panel manufacturer's metal suspension systems of types, structural classifications, materials, and finishes indicated that comply with applicable ASTM C 635 requirements. Provide systems complete with splice plates, connector/alignment clips, hangers, trim, seismic load clips and struts, and other suspension components required to support ceiling and other ceiling supported construction (some of these parts may be supplied by the installer).
  1. Standard "Heavy Duty" tee bar (as per ASTM A 635), factory slotted to receive torsion springs.
- B. Attachment Devices: Size for five times design load indicated in ASTM C 635, Table 1, Direct Hung, unless otherwise indicated – supplied by installer
  1. Cast-in-Place and Post installed Anchors in Concrete: Anchors of type and material indicated below, with holes or loops for attaching hangers of type indicated and with capability to sustain, without failure, a load equal to five times that imposed by ceiling construction, as determined by testing per ASTM E488, conducted by a qualified testing agency.
    - a. Type: Cast-in-place anchors.
    - b. Type: Post-installed expansion anchors.
    - c. Type: Chemical anchors.
    - d. Corrosion Protection: Carbon steel components zinc plated to comply with ASTM B 633, Class Fe/Zn 5 (5cm) for Class SC service conditions (mild).
    - e. Corrosion Protections: Stainless-steel components complying with ASTM F 593 and ASTM F 594, Group 1 alloy 304 or 316 for bolts; alloy 304 or 316 for anchor.
    - f. Corrosion Protection: Components fabricated from nickel-copper-alloy rods complying with ASTM B 164 for UNS No. N04400 alloy.

## 2.06 FINISHES

- A. Acoustic Unit and Suspension System Color(s) as selected by Architect from:
  - 1. Manufacturer's full range of standard colors.
- B. Multiple color selections will be required as shown on the Drawings. If none are shown, request from the Architect.

## 2.07 ACCESSORIES

- A. Support Channels and Hangers, stabilizer bars, clips, splices: Galvanized steel; size and type to suit application, seismic requirements, and ceiling system flatness requirement specified.
- B. Perimeter Moldings: Same metal and finish as grid.
  - 1. Size: As required for installation conditions and specified Seismic Design Category.
  - 2. Angle Molding: L-shaped, for mounting at same elevation as face of grid.
  - 3. Acoustical Sealant For Perimeter Moldings: Non-hardening, non-skinning, for use in conjunction with suspended ceiling system.
  - 4. At Exposed Grid: Provide L-shaped molding for mounting at same elevation as face of grid.
- C. Ceiling Suspension Wire: Class 1 zinc coated (galvanized) carbon steel conforming to ASTM A641-09a, #12 gage (0.106 inch diameter) with soft temper and minimum tensile strength = 70 ksi.
- D. Galvanized Sheet Steel (including that used for metal stud and track compression struts/posts): ASTM A653-11, or other equivalent sheet steel listed in Section A2.1 of the North American Specification for the Design of Cold-Formed Steel Structural Members 2007, including supplement 2 dated 2010 (AISI S100-07/S2-10).
  - 1. Material 43 mil (18 gage) and lighter: minimum yield strength of 33 ksi.
  - 2. Material 54 mil (16 gage) and heavier: minimum yield strength of 50 ksi.
- E. Electrical Metallic Tube (EMT): ANSI C80.3/UL 797 carbon steel with G90 galvanizing; minimum yield strength (Fy) of 30 ksi and minimum ultimate strength (Fu) of 48 ksi.
- F. Sheet Metal Screws: ASTM C1513-10, ASME B18.6.4-89 (R2005). Length as required so that penetration of screws through joined material shall not be less than three exposed threads.
- G. Acoustical Sealant For Perimeter Moldings: Non-hardening, non-skinning, for use in conjunction with suspended ceiling system., type recommended by ceiling manufacturer and complying with requirements of Section 07 9200.
- H. Gasket For Perimeter Moldings: Closed cell rubber sponge tape.
- I. Touch-up Paint: Type and color to match acoustical and grid units.

## PART 3 EXECUTION

### 3.01 EXAMINATION

- A. Examine substrates and structural framing to which acoustical metal panels attach or abut, with Installer present, for compliance with requirements specified in this and other Sections that affect installation and anchorage, and other conditions affecting performance of acoustical metal pan ceilings.
- B. Verify that layout of hangers will not interfere with other work.
- C. Proceed with installation only after unsatisfactory conditions have been corrected.

### 3.02 INSTALLATION - SUSPENSION SYSTEM

- A. Install suspension system in accordance with ASTM C636/C636M, ASTM E580/E580M, and manufacturer's instructions and as supplemented in this section.
  - 1. Install suspension system as required by California Code of Regulations Chapter 1616A.1.21, DSA IR(s), and as supplemented in this section.
- B. Rigidly secure system, including integral mechanical and electrical components, for maximum deflection of 1:360.
- C. Locate system on room axis according to reflected ceiling plan.
  - 1. Measure each ceiling area and establish layout of acoustical metal pan units to balance border widths at opposite edges of each ceiling. Avoid using less-than-half-width units at borders, and comply with layout shown on reflected ceiling plans.
- D. Coordinate layout with lighting fixtures, air outlets, partitions and other adjoining work.
- E. In exitways install with a main runner or cross-runner surrounding all sides of each ceiling unit and each light fixture or grille.
- F. Provide expansion joints at intersections and junctions of corridors, lobbies and other similar areas.
- G. Attach surface mounted fixtures to the main runner with at least two positive clamping devices composed of minimum 14 gauge steel. Rotational spring catches do not comply.
- H. Locate concrete reinforcement and prestressing tendons by non-destructive means prior to installing post - installed anchors. Do not damage reinforcing or tendons by anchor placement.
- I. Welding: In accordance with AWS D1.3 using E60XX series electrodes.
- J. Seismic Restraints: install in accordance with ASTM E 580, referenced standards and governing codes.
- K. Install after major above-ceiling work is complete. Coordinate the location of hangers with other work.
- L. Provide hanger clips during steel deck erection. Provide additional hangers and inserts as required.
- M. Hang suspension system independent of walls, columns, ducts, pipes and conduit. Where carrying members are spliced, avoid visible displacement of face plane of adjacent members.
- N. Where ducts or other equipment prevent the regular spacing of hangers, reinforce the nearest affected hangers and related carrying channels to span the extra distance.
- O. Do not eccentrically load system or induce rotation of runners.
- P. Form expansion joints as detailed. Accommodate plus or minus movement as indicated and to conform to referenced requirements. Maintain visual closure.

### 3.03 INSTALLATION

- A. General: Install acoustical metal pan ceilings to comply with publications referenced below, per manufacturer's written instructions, and Cisca "Ceiling Systems Handbook."
  - 1. Standard for Ceiling Suspension System Installations: Comply with ASTM C 636.
  - 2. Standard for Ceiling Suspension Systems Requiring Seismic Restraint: Comply with ASTM E 580 and CBC California Building Code) standard for Seismic Zone indicated.
- B. Suspend ceiling hangers from building's structural members and as follow:

1. Install hangers plumb and free from contact with insulation or other objects within ceiling plenum that are not part of supporting structure or of ceiling suspension system.
  2. Splay hangers only where required to miss obstructions; offset resulting horizontal forces by bracing, counter-splaying, or other equally effective means.
  3. Where width of ducts and other construction within ceiling plenum produces hanger spacings that interfere with location of hangers at spacing required to support standard suspension system members, install supplemental suspension members and hangers in form of trapezes or equivalent devices. Size supplemental suspension members and hangers to support ceiling loads within performance limits established by referenced standards and publications.
  4. Where used secure wire hangers to ceiling suspension members and to supports above with a minimum of three tight turns. Connect hangers directly either to structures or to inserts, eye screws, or other devices that are secure; that are appropriate for substrate; and that will not deteriorate or otherwise fail due to age, corrosion, or elevated temperatures.
  5. Space hangers not more than 48 inches on center, along each member supported directly from hangers, unless otherwise indicated; and provide hangers not more than 8 inches from ends of each member. Supply supporting calculations from licensed structural Architect verifying hanger spacing meets all requirements.
  6. Fine level grid to 1/8 inch in 10 feet from specified elevation(s), square and true.
- C. Secure bracing wires to ceiling suspension members and to supports acceptable to Architect. Suspend bracing from building's structural members as required for hangers, without attaching to permanent metal forms, steel deck, or steel deck tabs. Where approved by the Architect, fasten bracing into concrete with cast-in-place or post-installed anchors.
- D. Install edge moldings and trim of type indicated at perimeter of acoustical ceiling area and where necessary to conceal edges of acoustical metal pan. Method of edge trim attachment and design of edge trims to be approved by Architect.
1. Apply acoustical sealant in a continuous ribbon concealed on back of vertical legs of moldings before they are installed.
  2. Screw attach moldings to substrate at intervals not more than 18" O.C. and not more than 6" from ends, leveling with ceiling suspension system to a tolerance of 1/8" in 10'. Miter corners accurately and connect securely.
  3. Do not use exposed fasteners, including pop rivets, on moldings and trim without prior written approval. Or unless detailed otherwise
- E. Install suspension system runners so they are square (within .5 degree from 90 degrees) and securely interlocked with one another. Remove and replace dented, bent, or kinked members.
- F. Scribe and cut acoustical metal panel units for accurate fit at penetrations by, other work through ceilings. Stiffen edges of cut units as required to eliminate evidence of buckling or variations in flatness exceeding referenced standards for stretcher-leveled metal sheet.
- G. Install acoustical metal panel units in coordination with suspension system.
1. Align joints in adjacent courses to form uniform, straight joints parallel to room axis in both directions, unless otherwise indicated. Install directionally patterned or textured panels in directions indicated on approved shop drawings. Panel-joints shall flow smoothly and in a straight line within 1/8" in 10'. Intersections shall be continuous.
  2. Fit adjoining units to form flush, tight joints. Scribe and cut units for accurate fit at borders and around construction penetrating ceiling.
  3. Remove protective film from panels only when space is completely clean and free of airborne particles. Use white cotton gloves for final installation of panels into grid system.

**3.04 FACILITY SERVICES WITHIN THE CEILING:**

- A. Positively attach all flexible sprinkler hose fitting mounting brackets, ceiling-mounted air terminals, light fixtures, and other similar facility service items to the ceiling suspension systems by means of screws or approved fasteners with a minimum of two attachments required at each component.
- B. Provide #12 gage slack safety wire (s) attached from the service item to the structure above to each item as described below:
  - 1. Items weighing less than or equal to 20 lb. shall have one (1) safety wire.
  - 2. Items weighing more than 20 lb. but less than or equal to 56 lb. shall have two (2) safety wires (at diagonal corners).
  - 3. Items weighing more than 56 lb. shall be supported directly from the structure above by not less than four (4) taut #12 gage hanger wires or other approved hangers attached from the item to the structure above.
- C. Miscellaneous Devices: Attach all lightweight miscellaneous devices, such as strobe lights, occupancy sensors, speakers, exit signs, video cameras, etc., to the ceiling grid.
  - 1. For Devices weighing more than 10 lbs., provide #12 gage slack safety wire anchored to the structure above.
  - 2. For Devices weighing more than 20 lb., provide support independently from the structure above.

**3.05 TOLERANCES**

- A. Maximum Variation from Flat and Level Surface: 1/8 inch in 10 feet (3 mm in 3 m).
- B. Maximum Variation from Plumb of Grid Members Caused by Eccentric Loads: 2 degrees.

**3.06 TESTING**

- A. Perform all field testing in the presence of the project inspector.
- B. Post-Installed Anchors In Concrete: Field test power actuated fasteners for 200 lbs. in tension.
  - 1. Hanger Wire Anchors: Test at a frequency of 10 percent.
  - 2. Bracing Wire Anchors: Test at a frequency of 50 percent in accordance with CBC Section 1913A.7.
  - 3. All Other Post-Installed Anchors: Test in accordance with CBC Section 1913A.7.

**3.07 CLEANING**

- A. Comply with requirements of Section 01 7000.
- B. Clean soiled surfaces in accordance with manufacturer's printed instructions. Remove and replace, with new materials, tiles and suspension systems that are damaged or cannot be acceptably cleaned to the Architect's satisfaction.
- C. Repainting exposed parts of suspension system shall be with a paint type and application method recommended for use over metal surfaces.
- D. Upon completion of the work, remove all materials, containers, equipment and debris. Leave area in a clean condition.

**END OF SECTION**

**SECTION 09 6500**  
**RESILIENT FLOORING**

**PART 1 GENERAL**

**1.01 SECTION INCLUDES**

- A. Resilient sheet flooring.
- B. Resilient base.
- C. Installation accessories.

**1.02 RELATED REQUIREMENTS**

- A. Section 01 6116 - Volatile Organic Compound (VOC) Content Restrictions.
- B. Section 01 8113 - Sustainable Design Requirements.
- C. Section 03 3000 - Cast-in-Place Concrete: Restrictions on curing compounds for concrete slabs and floors.
- D. Section 03 3000 - Cast-In-Place Concrete.
- E. Pertinent sections specifying Concrete Floor Preparation, Concrete Floor Moisture Content & pH Testing and Water Vapor Emission Control Coating (Moisture Mitigation System).

**1.03 REFERENCE STANDARDS**

- A. ASTM E648 - Standard Test Method for Critical Radiant Flux of Floor-Covering Systems Using a Radiant Heat Energy Source; 2014c.
- B. ASTM F710 - Standard Practice for Preparing Concrete Floors to Receive Resilient Flooring; 2011.
- C. ASTM F1066 - Standard Specification for Vinyl Composition Floor Tile; 2004 (Reapproved 2014).
- D. ASTM F1303 - Standard Specification for Sheet Vinyl Floor Covering with Backing; 2004 (Reapproved 2014).
- E. ASTM F1344 - Standard Specification for Rubber Floor Tile; 2015.
- F. ASTM F1859 - Standard Specification for Rubber Sheet Floor Covering Without Backing; 2014.
- G. ASTM F1861 - Standard Specification for Resilient Wall Base; 2008 (Reapproved 2012).
- H. ASTM F2195 - Standard Specification for Linoleum Floor Tile; 2013.
- I. California Code of Regulations, Title 24, Part 2, California Building Code (CBC), International Building Code.
- J. California Code of Regulations, Title 24, Part 11 California Green Building Standards Code, "CAL-Green".
- K. ASTM F 1869 - Standard Test Method for Measuring Moisture Vapor Emission Rate of Concrete Subfloor Using Anhydrous Calcium Chloride, latest Edition.
- L. NFPA 253 - Standard Method of Test for Critical Radiant Flux of Floor Covering Systems Using a Radiant Heat Energy Source; 2015.



#### **1.04 SUBMITTALS**

- A. See Section 01 3300 - Submittals, for submittal procedures.
- B. Provide complete submittals at the same time as submittals for work in related sections to permit review of complete and integrated systems and assemblies.
- C. Product Data: Provide data on specified products, describing physical and performance characteristics; including sizes, patterns and colors available; and installation instructions.
- D. CAL-GREEN Submittals:
  - 1. Product Data - VOC Limits: For adhesives sealants, fillers, primers and coatings, documentation including printed statement of VOC contents, comply with limits specified in related section.
  - 2. Product Data - Resilient Flooring: Documentation from an independent testing agency indicating compliance with the FloorScore Standard, or evidence of listing on the RFCI FloorScore database, or evidence of listing on the CHPS Product Registry.
- E. Shop Drawings: Indicate seaming plan for sheet goods. Indicate floor pattern layout and color selections for each field and accent color. Request floor patterns from Architect where no patterns are indicated.
- F. Selection Samples: Submit manufacturer's complete set of color samples for Architect's initial selection.
- G. Verification Samples: Submit two samples, \_\_\_ by \_\_\_ inch (\_\_\_ by \_\_\_ mm) in size illustrating color and pattern for each resilient flooring product specified.
- H. Maintenance Data: Include maintenance procedures, recommended maintenance materials, and suggested schedule for cleaning, stripping, and re-waxing.

#### **1.05 DELIVERY, STORAGE, AND HANDLING**

- A. Protect roll materials from damage by storing on end.

#### **1.06 FIELD CONDITIONS**

- A. Store materials for not less than 48 hours prior to installation in area of installation at a temperature of 70 degrees F (21 degrees C) to achieve temperature stability. Thereafter, maintain conditions above 55 degrees F (13 degrees C).

#### **1.07 EXTRA MATERIALS**

- A. See Section 01 6000 - Product Requirements, for additional provisions.
- B. Provide 100 sq ft (\_\_\_ sq m) of flooring, 50 lineal feet (\_\_\_ m) of base, and 5 percent of installed stair materials of each type and color specified.

### **PART 2 PRODUCTS**

#### **2.01 PERFORMANCE REQUIREMENTS**

- A. VOC Limits for adhesives, sealants, fillers, primers and coatings . Comply with limits specified in related section.
- B. Resilient Flooring VOC Emission Limits: Comply with CAL-GREEN 5.504.4.6; products must be listed on one of the following databases.
  - 1. Collaborative for High Performance Schools (CHPS) 2009 CA Criteria and Low Emitting Materials List (Product Registry); [www.chps.net](http://www.chps.net).
  - 2. Resilient Floor Covering Institute (RFCI) FloorScore Program, database of certified products; [www.scsglobalservices.com/services/floorscore](http://www.scsglobalservices.com/services/floorscore).

- C. ASTM D2047 Slip-Resistance: All Resilient Flooring Products shall meet or exceed Federal ADA recommendations of minimum Coefficient Of Friction of 0.6 for flat surfaces and 0.8 for sloped surfaces.
- D. Critical Radiant Flux (CRF): Minimum 0.45 watt per square centimeter, when tested in accordance with ASTM E 648 or NFPA 253.

## 2.02 SHEET FLOORING

- A. Rubber Sheet Flooring: 100 percent rubber composition, color and pattern through total thickness.
  - 1. Manufacturers:
    - a. Mondo [www.mondocontractflooring.com](http://www.mondocontractflooring.com).
    - b. Substitutions: See Section 01 6000 - Product Requirements.
  - 2. Minimum Requirements: Comply with ASTM F1859, Type 1, without backing.
  - 3. Critical Radiant Flux (CRF): Minimum 0.45 watt per square centimeter, when tested in accordance with ASTM E 648 or NFPA 253.
  - 4. Product: Kayar
  - 5. Color: As indicated on drawings
  - 6. Sheet Width: As indicated on drawings

## 2.03 TILE FLOORING

- A. Vinyl Composition Tile: Homogeneous, with color extending throughout thickness.
  - 1. Manufacturers:
    - a. Tarkett: Meshwork
    - b. Substitutions: See Section 01 6000 - Product Requirements.
  - 2. Minimum Requirements: Comply with ASTM F1066, of Class corresponding to type specified.
  - 3. Critical Radiant Flux (CRF): Minimum 0.45 watt per square centimeter, when tested in accordance with ASTM E 648 or NFPA 253.
  - 4. Tile shall be slip resistant.
  - 5. Size: As indicated on drawings.
  - 6. VOC Content Limits: As specified in Section 01 6116.
  - 7. Thickness: 0.120 inch (3.05mm)
  - 8. Pattern: As indicated on drawings.
  - 9. Colors: As indicated on the drawings.
- B. Linoleum Tile: Homogeneous wear layer bonded to backing, with color and pattern through wear layer thickness.
  - 1. Minimum Requirements: Comply with ASTM F2195, Type corresponding to type specified.
  - 2. Tile shall be slip resistant.
  - 3. Backing: Synthetic fabric.
  - 4. Thickness: 0.100 inch (2.5 mm), minimum, excluding backing.

## 2.04 RESILIENT BASE

- A. Base: Type TP, rubber, thermoplastic; top set Style A - Straight at Carpet flooring, Style B - Coved at resilient flooring.:
  - 1. Manufacturers:
    - a. Burke Flooring: [www.burkeflooring.com/#sle](http://www.burkeflooring.com/#sle).
    - b. Substitutions: See Section 01 6000 - Product Requirements.
  - 2. Critical Radiant Flux (CRF): Minimum 0.45 watt per square centimeter, when tested in accordance with ASTM E 648 or NFPA 253.
  - 3. Height: As indicated inch (\_\_\_\_ mm).
  - 4. Thickness: 0.125 inch (3.2 mm).

5. Finish: Satin.
6. Length: Roll.
7. Color: As indicated on drawings
8. Accessories: Premolded external corners and internal corners.

## **2.05 WATER VAPOR EMISSION CONTROL COATING**

- A. Type specified in Section 07 2633.

## **2.06 ACCESSORIES**

- A. Subfloor Filler: White premix latex; type recommended by adhesive material manufacturer.
  1. Exception: Provide grey cementitious types where required by flooring manufacturers.
- B. Primers, Adhesives, and Seam Sealer: Waterproof; types recommended by flooring manufacturer.
- C. Moldings, Transition and Edge Strips: Rubber.
  1. Types as indicated or required for specific applications.
- D. Filler for Coved Base: Plastic.
- E. Sealer and Wax: Types recommended by flooring manufacturer.

## **PART 3 EXECUTION**

### **3.01 EXAMINATION**

- A. Verify that wall surfaces are smooth and flat within the tolerances specified for that type of work, are dust-free, and are ready to receive resilient base.
- B. Cementitious Subfloors:
  1. Verify that substrates have been prepared and tested for moisture content and pH as specified in related sections.
  2. Verify preparation of substrate to specified flatness and levelness tolerances.
  3. Verify installation of Water Vapor Emission Control Coating (Moisture Mitigation System Coating) as specified in related section is complete.
  4. Verify that concrete sub-floor surfaces with Water Vapor Emission Control Coating are ready for resilient flooring installation by testing for moisture emission rate and alkalinity; obtain instructions if test results are not within limits recommended by resilient flooring manufacturer and adhesive materials manufacturer.
    - a. Test completed Water Vapor Emission Control Coating in accordance with ASTM F1869.
- C. Verify that required floor-mounted utilities are in correct location.

### **3.02 PREPARATION**

- A. If test results from Section 09 0512 are within limits recommended by resilient flooring manufacturer and adhesive materials manufacturer, prepare floor substrates for installation of flooring in accordance with Section 09 0511 and as recommended by flooring and adhesive manufacturers.
- B. If test results from Section 09 512 are not within limits recommended by resilient flooring manufacturer and adhesive materials manufacturer, verify installation of Water Vapor Emission Control Coating as specified in Section 07 2633 is complete.
- C. Remove sub-floor ridges and bumps. Fill minor low spots, cracks, joints, holes, and other defects with sub-floor filler to achieve smooth, flat, hard surface. Repair damage to Water Vapor Emission Control Coating where occurs and re-test as specified in Section 07 2633.
- D. Prohibit traffic until filler is fully cured.

- E. Clean substrate.
- F. Apply primer as required to prevent "bleed-through" or interference with adhesion by substances that cannot be removed.

### **3.03 Installation - General**

- A. Starting installation constitutes acceptance of sub-floor conditions.
- B. Install in accordance with manufacturer's written instructions.
- C. Adhesive-Applied Installation:
  - 1. Spread only enough adhesive to permit installation of materials before initial set.
  - 2. Fit joints and butt seams tightly.
  - 3. Set flooring in place, press with heavy roller to attain full adhesion.
- D. Where type of floor finish, pattern, or color are different on opposite sides of door, terminate flooring under centerline of door.
- E. Install edge strips at unprotected or exposed edges, where flooring terminates, and where indicated.
  - 1. Metal Strips: Attach to substrate before installation of flooring using stainless steel screws.
  - 2. Resilient Strips: Attach to substrate using adhesive.
- F. Scribe flooring to walls, columns, cabinets, floor outlets, and other appurtenances to produce tight joints.
- G. Install flooring in recessed floor access covers, maintaining floor pattern.
- H. At movable partitions, install flooring under partitions without interrupting floor pattern.

### **3.04 Installation - Sheet Flooring**

- A. Install in accordance with manufacturer's instructions.
- B. Spread only enough adhesive to permit installation of materials before initial set.
- C. Set flooring in place, press with heavy roller to attain full adhesion.
- D. Lay flooring with joints and seams parallel to longer room dimensions, to produce minimum number of seams. Lay out seams to avoid widths less than 1/3 of roll width; match patterns at seams.
- E. Double cut sheet at seams.
- F. Where floor finishes are different on opposite sides of door, terminate flooring under centerline of door.
- G. Install edge strips at unprotected or exposed edges, where flooring terminates, and where indicated. Secure resilient strips by adhesive.
- H. Scribe flooring to walls, columns, cabinets, floor outlets, and other appurtenances to produce tight joints.
- I. Inlay color feature strips for athletic striping, floor patterns or other designs to layout indicated. If no pattern layout is indicated, Architect will provide prior to installation.

### **3.05 Installation - Tile Flooring**

- A. Install in accordance with manufacturer's instructions.

- B. Mix tile from container to ensure shade variations are consistent when tile is placed, unless otherwise indicated in manufacturer's installation instructions.
- C. Spread only enough adhesive to permit installation of materials before initial set.
- D. Set flooring in place, press with heavy roller to attain full adhesion.
- E. Lay flooring with joints and seams parallel to building lines to produce symmetrical pattern.
  - 1. Lay grain all in one direction.
- F. Install plank tile with a random offset of at least 6 inches (152 mm) from adjacent rows.
- G. Lay out floor tile pattern for approval by Architect.
- H. Where floor finishes are different on opposite sides of door, terminate flooring under centerline of door.
- I. Install edge strips at unprotected or exposed edges, where flooring terminates, and where indicated.
- J. Scribe flooring to walls, columns, cabinets, floor outlets, and other appurtenances to produce tight joints.

### **3.06 Installation - Resilient Base**

- A. Fit joints tightly and make vertical. Maintain minimum dimension of 18 inches (45 mm) between joints.
- B. Miter internal corners. At external corners, use premolded units. At exposed ends, use premolded units.
- C. Install base on solid backing. Bond tightly to wall and floor surfaces.
- D. Scribe and fit to door frames and other interruptions.

### **3.07 CLEANING**

- A. Remove excess adhesive from floor, base, and wall surfaces without damage.
- B. Clean in accordance with manufacturer's written instructions.
- C. Clean, seal, and wax resilient flooring in accordance with manufacturer's instructions using manufacturer recommended products.

### **3.08 PROTECTION AND ADJUSTING OF FINISHED WORK**

- A. Prohibit traffic on resilient flooring for 48 hours after installation.
- B. Linoleum "Drying Room Film": Expose installed linoleum to either natural or artificial light to allow "drying room film" (the yellow film is a natural occurrence of the oxidation of the linseed oil in linoleum products) on installed linoleum flooring to disappear prior to initiating temporary protection procedures.
- C. Protect flooring during construction period in accordance with resilient flooring manufacturer's directions.
  - 1. Protect resilient flooring against damage from rolling loads for initial period following installation by covering with plywood or hardboard. Use dollies to move stationary equipment or furnishings across floors.
  - 2. Cover resilient flooring with undyed, untreated building paper until inspection for substantial completion.

- D. Adjusting: Following Owner's move-in, replace resilient flooring indicated as damaged by move-in operation, up to five percent of completed floor area.

**END OF SECTION**

**SECTION 09 6556**  
**SLIP-RESISTANT RESILIENT FLOORING**

**PART 1 GENERAL**

**1.01 SECTION INCLUDES**

- A. Resilient sheet flooring, slip-resistant, fabricated of recycled materials.
- B. Installation accessories.

**1.02 RELATED REQUIREMENTS**

- A. Section 01 6116 - Volatile Organic Compound (VOC) Content Restrictions.
- B. Section 01 8113 - Sustainable Design Requirements.
- C. Section 03 3000 - Cast-in-Place Concrete: Restrictions on curing compounds for concrete slabs and floors.
- D. Pertinent sections specifying Concrete Floor Preparation, Concrete Floor Moisture Content & pH Testing and Water Vapor Emission Control Coating (Moisture Mitigation System).

**1.03 REFERENCE STANDARDS**

- A. ASTM E648 - Standard Test Method for Critical Radiant Flux of Floor-Covering Systems Using a Radiant Heat Energy Source; 2014c.
- B. ASTM F710 - Standard Practice for Preparing Concrete Floors to Receive Resilient Flooring; 2011.
- C. ASTM F1066 - Standard Specification for Vinyl Composition Floor Tile; 2004 (Reapproved 2014).
- D. ASTM F1303 - Standard Specification for Sheet Vinyl Floor Covering with Backing; 2004 (Reapproved 2014).
- E. ASTM F1344 - Standard Specification for Rubber Floor Tile; 2015.
- F. ASTM F1861 - Standard Specification for Resilient Wall Base; 2008 (Reapproved 2012).
- G. California Code of Regulations, Title 24, Part 2, California Building Code (CBC), International Building Code.
- H. California Code of Regulations, Title 24, Part 11 California Green Building Standards Code, "CAL-Green".
- I. ASTM F 1869 - Standard Test Method for Measuring Moisture Vapor Emission Rate of Concrete Subfloor Using Anhydrous Calcium Chloride, latest Edition.

**1.04 SUBMITTALS**

- A. See Section 01 3300 - Submittals, for submittal procedures.
- B. Provide complete submittals at the same time as submittals for work in related sections to permit review of complete and integrated systems and assemblies.
- C. Product Data: Provide data on specified products, describing physical and performance characteristics; including sizes, patterns and colors available; and installation instructions.
- D. CAL-GREEN Submittals:
  - 1. Product Data - VOC Limits: For adhesives sealants, fillers, primers and coatings, documentation including printed statement of VOC contents, comply with limits specified in related section.

2. Product Data – Resilient Flooring: Documentation from an independent testing agency indicating compliance with the FloorScore Standard, or evidence of listing on the RFCI FloorScore database, or evidence of listing on the CHPS Product Registry.
- E. Shop Drawings: Indicate seaming plan for sheet goods. Indicate floor pattern layout and color selections for each field and accent color. Request floor patterns from Architect where no patterns are indicated.
- F. Selection Samples: Submit manufacturer's complete set of color samples for Architect's initial selection.
- G. Verification Samples: Submit two samples, 6 by 6 inch (\_\_\_ by \_\_\_ mm) in size illustrating color and pattern for each resilient flooring product specified.
- H. Maintenance Data: Include maintenance procedures, recommended maintenance materials, and suggested schedule for cleaning, stripping, and re-waxing.

#### 1.05 QUALITY ASSURANCE

- A. Manufacturer Qualifications: Company specializing in manufacturing specified flooring with minimum three years documented experience.
- B. Installer Qualifications: Company specializing in installing specified flooring with minimum three years documented experience and approved by flooring manufacturer.

#### 1.06 DELIVERY, STORAGE, AND HANDLING

- A. Protect roll materials from damage by storing on end.

#### 1.07 FIELD CONDITIONS

- A. Comply with manufacturer's written instructions for substrate temperature and humidity, ambient temperature and humidity, ventilation, and other conditions affecting the installation of Eco-Grip.
- B. Environmental Limitations: Do not install Eco-Grip flooring until building is enclosed and weatherproof, wet work is complete, and the HVAC system or temporary heating maintains temperature and humidity at normal occupancy levels.
  1. Acclimate Eco-Grip flooring parts for a minimum of 24 hours to the ambient temperature and humidity levels of spaces in which they are to be installed
- C. Verify that concrete substrate conditions provide for slope to drains allowing water flow without assistance to drainage points. ¼" per 1-foot average slope for radius' to 4' from drain center points are required.
  1. Verify that floor drains are set ¼" above with finished concrete surface, and that floor waste/grease sinks and troughs are level and set ¼" above the finished concrete surface to prevent floor drainage to those elements once the ¼" Eco-Grip floor is installed tight to these penetrations.
    - a. Slab substrates must be dry and free of curing compounds, sealers, hardeners, and other materials whose presence would interfere with bonding of adhesive.
- D. Verify a clean, dry, and structurally sound surface to accept adhesive, free of cracks, ridges, depression, scales, and foreign deposits of any kind.
- E. Verify that sub-floor concrete surfaces are ready for resilient flooring installation by testing moisture emission rate and alkalinity, in accordance with ASTM F 710; obtain instructions if test results are not within limits recommended by resilient flooring manufacturer and adhesive materials manufacturer.
  1. Reference ASTM F 710 - Standard Practice for Preparing Concrete Floors to Receive Resilient Flooring.



2. Do not begin installation of Eco-Grip flooring until all Project Conditions have been met.

#### **1.08 EXTRA MATERIALS**

- A. See Section 01 6000 - Product Requirements, for additional provisions.
- B. Provide 100 sq ft (\_\_\_\_ sq m) of flooring, 50 lineal feet (\_\_\_\_ m) of base, of each type and color specified.

#### **1.09 WARRANTY**

- A. Manufacturer must provide a limited 10-year product warranty against manufacturing defects. (With continued use of Eco-Grip Floor Cleaner)
- B. Eco-Grip factory trained installer must provide a 1-year installation defect warranty.

### **PART 2 PRODUCTS**

#### **2.01 PERFORMANCE REQUIREMENTS**

- A. VOC Limits for adhesives, sealants, fillers, primers and coatings . Comply with limits specified in related section.
- B. Resilient Flooring VOC Emission Limits: Comply with CAL-GREEN 5.504.4.6; products must be listed on one of the following databases.
  1. Collaborative for High Performance Schools (CHPS) 2009 CA Criteria and Low Emitting Materials List (Product Registry); [www.chps.net](http://www.chps.net).
  2. Resilient Floor Covering Institute (RFCI) FloorScore Program, database of certified products; [www.scsglobalservices.com/services/floorscore](http://www.scsglobalservices.com/services/floorscore).
- C. ASTM D2047 Slip-Resistance: All Resilient Flooring Products shall meet or exceed Federal ADA recommendations of minimum Coefficient Of Friction of 0.6 for flat surfaces and 0.8 for sloped surfaces.
- D. Critical Radiant Flux (CRF): Minimum 0.45 watt per square centimeter, when tested in accordance with ASTM E 648 or NFPA 253.

#### **2.02 SHEET FLOORING**

- A. Eco-Grip Safety Flooring as manufactured by Allied Industries International, Inc.
  1. Eco-Grip Commercial Flooring. Sheets 5' x 8' in 1/4" thickness.
  2. Made of recycled materials.
  3. Color as indicated on drawings.
  4. Performance Criteria:
    - a. ASTM G-21 Bacteria & Mildew Resistance: Excellent.
    - b. ASTM D-751 Breaking Strength (md) 405lbs.
    - c. ASTM D-751 Breaking Strength (cmd) 723lbs.
    - d. ASTM D-2047 Coefficient of Friction (avg) Dry 1.31.
    - e. ASTM D-695 Compressive Strength @ 20% Deformation 641 psi.
    - f. ASTM D-751 Elongation (md) 76.5%.
    - g. ASTM D-751 Elongation (cmd) 88.5%.
    - h. ASTM E-648 Critical Radiant Flux 1.05W/cm<sup>2</sup> - Type 1 NFPA fire classification.
    - i. ASTM E-648 Burn Distance 12 cm.
    - j. Shore A Hardness 85-90 avg.
    - k. ASTM D-751 Tear Strength (md) 76.5lbs.
    - l. ASTM D-751 Tear Strength (cmd) 84lbs.
    - m. NFSI UWT-101A Coefficient of Friction Standard >.06.
- B. Substitutions: See Section 01 6000 - Product Requirements.

- C. Accessories:
  - 1. Eco-Grip Epoxy Flooring Adhesive.
  - 2. Eco-Grip V-Rod, welding rod or SpeedFlex Liquid Welding System.
  - 3. Eco-Grip Polyvinyl Cove Base Cap (high impact Polyvinyl), Stainless Steel Base Cap, or Aluminum Base Cap.
  - 4. Stainless Steel drain rings and transition strips, and #10 stainless screws and lead anchors as required
  - 5. Eco-Grip sealants
  - 6. Other installation materials as required and supplied by Eco-Grip.
- D. Integral coved base with cap strip.

### **2.03 WATER VAPOR EMISSION CONTROL COATING**

- A. Type specified in Section 07 2633.

### **2.04 ACCESSORIES**

- A. Eco-Grip Epoxy Flooring Adhesive.
- B. Eco-Grip V-Rod, welding rod or SpeedFlex Liquid Welding System.
- C. Eco-Grip Polyvinyl Cove Base Cap (high impact Polyvinyl), Stainless Steel Base Cap, or Aluminum Base Cap.
- D. Stainless Steel drain rings and transition strips, and #10 stainless screws and lead anchors as required
- E. Eco-Grip sealants.
- F. Other installation materials as required and supplied by Eco-Grip.
- G. Subfloor Filler: White premix latex; type recommended by adhesive material manufacturer.
  - 1. Exception: Provide grey cementitious types where required by flooring manufacturers.
- H. Primers, Adhesives, and Seam Sealer: Waterproof; types recommended by flooring manufacturer.
- I. Moldings, Transition and Edge Strips: Rubber.
  - 1. Types as indicated or required for specific applications.
- J. Filler for Coved Base: Plastic.
- K. Sealer and Wax: Types recommended by flooring manufacturer.

## **PART 3 EXECUTION**

### **3.01 EXAMINATION**

- A. Verify that wall surfaces are smooth and flat within the tolerances specified for that type of work, are dust-free, and are ready to receive resilient base.
- B. Cementitious Subfloors:
  - 1. Verify that substrates have been prepared and tested for moisture content and pH as specified in related sections.
  - 2. Verify preparation of substrate to specified flatness and levelness tolerances.
  - 3. Verify installation of Water Vapor Emission Control Coating (Moisture Mitigation System Coating) as specified in related section is complete.
  - 4. Verify that concrete sub-floor surfaces with Water Vapor Emission Control Coating are ready for resilient flooring installation by testing for moisture emission rate and alkalinity; obtain instructions if test results are not within limits recommended by resilient flooring manufacturer and adhesive materials manufacturer.

- a. Test completed Water Vapor Emission Control Coating in accordance with ASTM F1869.
- C. Verify that required floor-mounted utilities are in correct location.

### **3.02 PREPARATION**

- A. If test results from Section 09 0512 are within limits recommended by resilient flooring manufacturer and adhesive materials manufacturer, prepare floor substrates for installation of flooring in accordance with Section 09 0511 and as recommended by flooring and adhesive manufacturers.
- B. If test results from Section 09 512 are not within limits recommended by resilient flooring manufacturer and adhesive materials manufacturer, verify installation of Water Vapor Emission Control Coating as specified in Section 07 2633 is complete.
- C. Remove sub-floor ridges and bumps. Fill minor low spots, cracks, joints, holes, and other defects with sub-floor filler to achieve smooth, flat, hard surface. Repair damage to Water Vapor Emission Control Coating where occurs and re-test as specified in Section 07 2633.
- D. Prohibit traffic until filler is fully cured.
- E. Clean substrate.
- F. Apply primer as required to prevent "bleed-through" or interference with adhesion by substances that cannot be removed.

### **3.03 Installation - General**

- A. Starting installation constitutes acceptance of sub-floor conditions.
- B. Install in accordance with manufacturer's written instructions.
- C. Adhesive-Applied Installation:
  - 1. Spread only enough adhesive to permit installation of materials before initial set.
  - 2. Fit joints and butt seams tightly.
  - 3. Set flooring in place, press with heavy roller to attain full adhesion.
- D. Where type of floor finish, pattern, or color are different on opposite sides of door, terminate flooring under centerline of door.
- E. Install edge strips at unprotected or exposed edges, where flooring terminates, and where indicated.
  - 1. Metal Strips: Attach to substrate before installation of flooring using stainless steel screws.
  - 2. Resilient Strips: Attach to substrate using adhesive.
- F. Scribe flooring to walls, columns, cabinets, floor outlets, and other appurtenances to produce tight joints.
- G. Install flooring in recessed floor access covers, maintaining floor pattern.
- H. At movable partitions, install flooring under partitions without interrupting floor pattern.

### **3.04 INSTALLATION - SLIP-RESISTANT RESILIENT SHEET FLOORING**

- A. Follow manufacturer recommendations for laying sheets out. All welded joints must be offset with flooring sheets installed in an Ashlar fashion.
- B. Flooring must be cut tight to all penetrations.

- C. Adhere the floor material with Eco-Grip 2-part Epoxy mastic using the manufacturer's recommended trowel notch size (3/32).
- D. Eco-Grip seal cartridge adhesive/sealant should be used to seal base top and cap per the "Base Cap Detail" drawing, around all drains and sinks, and at all floor penetrations and transitions.
- E. Roll floor into adhesive with 100lb roller immediately
- F. Install floor drains in accordance with drawing for "Stainless Collar Floor Drain Detail" drawings. Stainless steel drain rings are to be routed into floor surface and mounted flush with top of flooring. Secure drain rings using stainless steel fasteners and lead anchors that will properly anchor the ring to the substrate.
- G. Install cove base as recommended by manufacturer with proper adhesive and top sealant.
  - 1. Route out V-grooves between sheets and weld all seams using Eco-Grip 7mm V- shaped welding rod or Eco-Grip SpeedFlex liquid weld system along with specified tools in accordance with Eco-Grip Floorings installation guidelines.
    - a. 16-gauge Stainless steel transitions are to be installed at all doorways and transition areas. Use stainless steel fasteners, and lead anchors to secure.
- H. All exposed edges are to be sealed with manufacturer's recommended sealant to assure a watertight seal.
- I.

### **3.05 CLEANING**

- A. Remove excess adhesive from floor, base, and wall surfaces without damage.
- B. Sweep-clean the floor after installation and clear area of scrap materials. The floor can be saturated and then deck brushed, power washed, or power scrubbed (only use the 3M Green Cleaning Pad) to remove construction debris.
- C. Clean in accordance with manufacturer's written instructions.
- D. Clean, seal, and wax resilient flooring in accordance with manufacturer's instructions using manufacturer recommended products.

### **3.06 PROTECTION AND ADJUSTING OF FINISHED WORK**

- A. Prohibit traffic on resilient flooring for 48 hours after installation.
- B. Protect flooring during construction period in accordance with resilient flooring manufacturer's directions.
  - 1. Protect resilient flooring against damage from rolling loads for initial period following installation by covering with plywood or hardboard. Use dollies to move stationary equipment or furnishings across floors.
  - 2. Cover resilient flooring with undyed, untreated building paper until inspection for substantial completion.
- C. Adjusting: Following Owner's move-in, replace resilient flooring indicated as damaged by move-in operation, up to five percent of completed floor area.

**END OF SECTION**

**SECTION 09 6700**  
**FLUID-APPLIED FLOORING**

**PART 1 GENERAL**

**1.01 SECTION INCLUDES**

- A. Fluid-applied flooring and base.
  - 1. Medium Duty.

**1.02 RELATED REQUIREMENTS**

- A. Section 01 6116 - Volatile Organic Compound (VOC) Content Restrictions.
- B. Section 03 3000 - Cast In Place Concrete
- C. Pertinent sections specifying Concrete Floor Preparation and Concrete Floor Moisture Content.

**1.03 REFERENCE STANDARDS**

- A. ASTM C 307 - Standard Test Method for Tensile Strength of Chemical Resistant Mortar, Grouts, and Monolithic Surfacing.
- B. ASTM C 413 - Standard Test Method for Absorption of Chemical-Resistant Mortars, Grouts, Monolithic Surfacing, and Polymer Concretes.
- C. ASTM C579 - Standard Test Method for Compressive Strength of Chemical Resistant Mortar, Grouts, Monolithic Surfacing and Polymer Concretes.
- D. ASTM D570 - Standard Test Method for Water Absorption of Plastics; 1998 (Reapproved 2010).
- E. ASTM D638 - Standard Test Method for Tensile Properties of Plastics; 2014.
- F. ASTM D905 - Standard Test Method for Strength Properties of Adhesive Bonds in Shear by Compression Loading; 2008 (Reapproved 2013).
- G. ASTM D2047 - Standard Test Method for Static Coefficient of Friction of Polish-Coated Flooring Surfaces as Measured by the James Machine, 2004.
- H. ASTM D2794 - Standard Test Method for Resistance of Organic Coatings to the Effects of Rapid Deformation (Impact), 2010.
- I. ASTM E648 - Standard Test Method for Critical Radiant Flux of Floor-Covering Systems Using a Radiant Heat Energy Source; 2014c.
- J. MIL-PRF-24613A, Performance Specification: Deck Covering Materials, Interior, Cosmetic Polymeric (03 Nov 2007).

**1.04 SUBMITTALS**

- A. See Section 01 3300 - Submittals, for submittal procedures.
- B. Product Data: Provide data on specified products, describing physical and performance characteristics; sizes, patterns and colors available . Demonstrate compliance with specified attributes.
- C. VOC Submittals:
  - 1. Product Data - VOC Limits: For adhesives sealants, fillers and primers, documentation including printed statement of VOC contents.

- D. Qualifications: For Manufacturer and Applicator. Demonstrate compliance with specified attributes.
- E. Samples: Submit two samples,   8  by  8   inch (      by       mm) in size illustrating color and pattern for each floor material for each color specified.
- F. Manufacturer's Installation Instructions: Indicate special procedures.
- G. Maintenance Data: Include maintenance procedures, recommended maintenance materials, procedures for stain removal, repairing surface, and suggested schedule for cleaning.
- H. Maintenance Materials: Furnish the following for Owner's use in maintenance of project.
  - 1. See Section 01 6000 - Product Requirements, for additional provisions.
  - 2. Extra Top Coat Materials: 2 gallons (8 liters).

#### **1.05 QUALITY ASSURANCE**

- A. Manufacturer Qualifications: Company specializing in manufacturing products specified in this section with minimum three years documented experience.
- B. Applicator Qualifications: Manufacturer's Applicators specializing in performing work of this section with minimum ten years experience.
- C. Manufacturer's representative shall be available to advise applicator on proper surface preparation and application techniques.

#### **1.06 MOCK-UP**

- A. Construct mock-up(s) of fluid applied flooring to serve as basis for evaluation of texture and workmanship.
  - 1. Number of Mock-Ups to be Prepared: One.
  - 2. Use same materials and methods for use in the work.
  - 3. Use approved design samples as basis for mock-ups.
  - 4. Locate where directed.
  - 5. Minimum Size: 48 inches by 48 inches (1220 mm by 1220 mm).
- B. Obtain approval of mock-up by Architect before proceeding with work.

#### **1.07 MOCK-UP**

- A. Following review of complete submittals, Provide complete mock-up, 6 feet (       m) long by 6 feet (       m) wide, illustrating finish color and texture.
- B. Locate where directed.
- C. Mock-up may remain as part of the Work.

#### **1.08 DELIVERY, STORAGE, AND HANDLING**

- A. Store resin materials in a dry, secure area.
- B. Store materials for three days prior to installation in area of installation to achieve temperature stability.

#### **1.09 PROJECT CONDITIONS**

- A. Sequence cabinet base and wall finish installation prior to fluid flooring to enable installation of integral coved flooring base in a single operation.
- B. Coordinate fluid flooring installation with size, location and installation of service utilities.

## 1.10 FIELD CONDITIONS

- A. Maintain minimum temperature in storage area of 55 degrees F (13 degrees C).
- B. Maintain ambient temperature required by manufacturer 72 hours prior to, during, and 24 hours after installation of materials.

## PART 2 PRODUCTS

### 2.01 MANUFACTURERS

- A. Fluid-Applied Flooring:
  - 1. Tera-Lite, Inc.; www.tera-lite.com
- B. Substitutions: See Section 01 6000 - Product Requirements.

### 2.02 Fluid-Applied Flooring SYSTEMS

- A. VOC Limits for adhesives sealants, fillers, coatings and primers. Comply with limits specified in Section 01 6116.
- B. Provide Fluid-Applied Flooring with specified adhesion to concrete floors at up to 100% Relative Humidity as measured by ASTM D 2170, in situ probe testing.
- C. Fluid-Applied Troweled Flooring System, Medium Duty Type FF1: Epoxy, polymer modified, water-dispersed cementitious, three component, nominal 3/16 inch thickness.
  - 1. Products:
    - a. Tera-Lite; Tera-Gem III Decorative Quality (DQ) Troweled.
    - b. Substitutions: See Section 01 6000 - Product Requirements.
  - 2. Components:
    - a. Epoxy Primer: Manufacturer's standard penetrating two-component type.
    - b. Base Coat: 1/8 inch (3 mm) thick; selected color, three component mortar consisting of epoxy resin, curing agent and finely graded aggregates.
    - c. Undercoat (Receiving Coat): 100% solids epoxy formulation, three component, free-flowing.
    - d. Top Coat: Epoxy, single component; UV resistant, 1/16 inch (\_\_\_\_ mm) thick; clear color.
    - e. Non-slip Surfacing: Quartz Aggregate, manufacturer's standard integral color type, suitable for broadcast application, selected color blend. Install to produce Coefficient of Friction between 0.7 and 0.8
  - 3. Performance Criteria:
    - a. Tensile Strength: 2,000 psi (1,700 MPa), when tested in accordance with ASTM D 307.
    - b. Compressive Strength: 7,500 psi (10,000 MPa), when tested in accordance with ASTM C 579.
    - c. Water Absorption: <0.1 percent, when tested in accordance with ASTM C 413 for 24 hr.
    - d. Mildew Resistance: No growth.
    - e. Adhesion in Shear (Bond) Strength: 300 PSI or failure of concrete bond minimum, when tested in accordance with ASTM D4541.
    - f. Impact Resistance: \_\_\_\_ in/lb (60 Nm); no cracking, chipping or delamination, when tested in accordance with ASTM D2794 or MILPRF24613.
    - g. Flammability: Self-Extinguishing (Class I) per ASTM E648.
    - h. Color: Selected from full range of available colors. Minimum of 7 colors in product line.
    - i. VOC Content: 100 g/l or less.

- j. Coefficient of Friction, Installed: 0.60 minimum, wet, measured in accordance with ASTM D2047.
- D. Topical Vapor Control Coating for Fluid Flooring: Cementitious, polymer-modified three component, nominal 1/16 - 1/8 inch thickness, compatible with fluid-applied flooring. Allow successful installation of fluid applied flooring over concrete of 100 % Relative Humidity as measured by ASTM D2170 in situ probe.
  - 1. Primer: Manufacturer's standard penetrating type.
  - 2. Base Coat: 1/8 inch (3 mm) thick; selected color, polymer-modified mortar consisting of liquid latex resin and finely graded aggregates.

### **2.03 FINISHES**

- A. Color(s) as indicated on drawings.
- B. Multiple color selections will be required as shown on the Drawings. If none are shown, request from the Architect.

### **2.04 ACCESSORIES**

- A. Base caps: Type recommended by manufacturer for conditions required.
- B. Cant Strips: Molded of flooring resin material.
- C. Primer: Type recommended by manufacturer for substrate and body coats indicated.
- D. Patching and Fill Material: Resinous product of or approved by epoxy coating manufacturer and recommended by manufacturer for application indicated.
- E. Sealant: manufacturer's recommended type, suitable for conditions required.
- F. Cleaners: Heavy-duty industrial detergent, manufacturer's recommended type, suitable for conditions required.
- G. Primers and Adhesives: Waterproof; types recommended by flooring manufacturer.

## **PART 3 EXECUTION**

### **3.01 EXAMINATION**

- A. Cementitious Subfloors:
  - 1. Verify that substrates have been prepared and tested for moisture content and pH as specified in related sections.
  - 2. Verify preparation of substrate to specified flatness and levelness tolerances as specified in related sections.
  - 3. Verify substrate has been mechanically cleaned and surface profiled as specified in related sections.
- B. Verify that sub-floor surfaces are dust-free and free of substances that could impair bonding of materials to sub-floor surfaces.
- C. Verify that sub-floor surfaces are sloped to drain, free of ponding areas or conditions which would impair positive drainage when installation is complete. Flood-test with water to confirm free drainage.
- D. Verify that required floor-mounted utilities are in correct location.

### **3.02 PREPARATION**

- A. Crack Repair: Repair concrete slab cracks as recommended, using materials recommended by the flooring manufacturer and included in their warranty. Quantity Allowance: One lineal foot of crack repair per square foot of floor installation.



- B. Apply, trowel, and float filler to achieve smooth, flat, hard surface with positive drainage configuration. Grind irregularities above the surface level. Prohibit traffic until filler is cured.
- C. Vacuum clean substrate.
- D. Apply primer to surfaces required by flooring manufacturer.
- E. Install topical vapor control coating for fluid flooring complete with primer and recommended accessories at all areas indicated to receive fluid-flooring.

### **3.03 INSTALLATION - Accessories**

- A. Install cant strips at base of walls where flooring is to be extended up wall as base.
- B. Install terminating cap strip at top of base; install "H" or "T" channel configurations as required to suit specific conditions where wall panel finishes abut base; attach securely to wall substrate.

### **3.04 INSTALLATION - FLOORING**

- A. Apply in accordance with manufacturer's instructions.
- B. Apply each coat to minimum thickness required by manufacturer, free from trowel marks, swirls, pooled glaze or imperfections. Completed mock-up shall serve as appearance and texture standard for completed work.
- C. Apply first coat of clear sealer and broadcast aggregate to refusal and allow to cure as required by manufacturer. Sweep off excess aggregate and apply second seal coat to obtain specified thickness and surface finish textures matching approved mockups.
- D. Finish to smooth level surface with positive drainage as indicated. No ponding or birdbaths, all surface water flows to drain.
- E. Fillet and cove at vertical surfaces.
- F. Install sealants at perimeter and transition conditions in accordance with manufacturer's standard details and installation recommendations.

### **3.05 FIELD QUALITY CONTROL**

- A. Following manufacturer's recommended curing period, and prior to installation of further work, flood completed floor with water in presence of Owner's Inspector to verify positive drainage.
- B. Completed work shall exhibit positive drainage, free from ponding or "birdbaths", with uniform color and texture consistent with the granular character of the flooring material, free of pooled,"swirled", or glazed topcoat, with surface finish textures matching approved mockups.
- C. Immediately remove and replace work not conforming to these requirements.
- D. Adjust textures at no cost to Owner at locations where finish textures do not match approved mockups:
  - 1. Too Rough: Apply additional coats of glaze topcoat until texture is acceptable.
  - 2. Too Smooth: Apply additional broadcast of aggregate and lock-in with additional glaze top coat until texture is acceptable.

### **3.06 PROTECTION**

- A. Prohibit traffic on floor finish for 48 hours after installation.

- B. Barricade area to protect flooring until fully cured.

**3.07 SCHEDULE**

- A. Epoxy Floor Coating - Medium Duty: Total Assembly thickness 3/16 inch (188 mil) minimum.
1. Surface Preparation - Concrete: SSPC-SP13 / NACE No. 6 Surface Preparation of Concrete, minimum concrete surface profile (CSP) 4-6 per ICRI Technical Guideline 03741, as recommended by Fluid Flooring Manufacturer.
  2. Repair cracks.
  3. Topical Vapor Control Coating: If floor substrate Relative Humidity is outside manufacturer's recommended range, apply Topical Vapor Control Coating to horizontal surfaces, over prime coats as recommended by Manufacturer.
  4. Primer: Apply prime coats to surfaces if recommended by Manufacturer.
  5. Mortar / Slurry Base Coat: 3/16 inch (188 mils) DFT.
  6. Color Finish / Topcoat: Color as selected; 8.0 to 12.0 mils DFT.
  7. Integral Color Aggregate Broadcast to Refusal.
  8. Clear Topcoat, minimum two: 8.0 to 12.0 mils DFT, total.

**END OF SECTION**

**SECTION 09 6770**  
**FLUID-APPLIED CORK FLOORING**

**PART 1 GENERAL**

**1.01 SECTION INCLUDES**

- A. Fluid applied, seamless resilient floor covering, made from vegetable oil, linseed oil, wood and cork powder, limestone, cork and other natural pigments, and base.

**1.02 RELATED REQUIREMENTS**

- A. Section 01 6116 - Volatile Organic Compound (VOC) Content Restrictions.
- B. Section 07 9200 - Joint Sealants: Sealing joints between fluid-applied flooring and adjacent construction and fixtures.
- C. Section 03 3000 - Cast In Place Concrete
- D. Pertinent sections specifying Concrete Floor Preparation and Concrete Floor Moisture Content.

**1.03 REFERENCE STANDARDS**

- A. ASTM C 307 - Standard Test Method for Tensile Strength of Chemical Resistant Mortar, Grouts, and Monolithic Surfacing.
- B. ASTM C 413 - Standard Test Method for Absorption of Chemical-Resistant Mortars, Grouts, Monolithic Surfacing, and Polymer Concretes.
- C. ASTM C579 - Standard Test Method for Compressive Strength of Chemical Resistant Mortar, Grouts, Monolithic Surfacing and Polymer Concretes.
- D. ASTM D905 - Standard Test Method for Strength Properties of Adhesive Bonds in Shear by Compression Loading; 2008 (Reapproved 2013).
- E. ASTM D2794 - Standard Test Method for Resistance of Organic Coatings to the Effects of Rapid Deformation (Impact), 2010.
- F. ASTM E648 - Standard Test Method for Critical Radiant Flux of Floor-Covering Systems Using a Radiant Heat Energy Source; 2014c.

**1.04 SUBMITTALS**

- A. See Section 01 3300 - Submittals, for submittal procedures.
- B. Product Data: Provide data on specified products, describing physical and performance characteristics; sizes, patterns and colors available . Demonstrate compliance with specified attributes.
- C. VOC Submittals:
  - 1. Product Data - VOC Limits: For adhesives sealants, fillers and primers, documentation including printed statement of VOC contents.
- D. Qualifications: For Manufacturer and Applicator. Demonstrate compliance with specified attributes.
- E. Samples: Submit two samples,   8   by   8   inch (       by        mm) in size illustrating color and pattern for each floor material for each color specified.
- F. Manufacturer's Installation Instructions: Indicate special procedures.

- G. Maintenance Data: Include maintenance procedures, recommended maintenance materials, procedures for stain removal, repairing surface, and suggested schedule for cleaning.
- H. Maintenance Materials: Furnish the following for Owner's use in maintenance of project.
  - 1. See Section 01 6000 - Product Requirements, for additional provisions.
  - 2. Extra Top Coat Materials: 2 gallons (8 liters).

#### **1.05 QUALITY ASSURANCE**

- A. Manufacturer Qualifications: Company specializing in manufacturing products specified in this section with minimum three years documented experience.
- B. Applicator Qualifications: Company specializing in performing the work of this section.
  - 1. Approved by manufacturer.
- C. Manufacturer's representative shall be available to advise applicator on proper surface preparation and application techniques.

#### **1.06 MOCK-UP**

- A. Construct mock-up(s) of fluid applied flooring to serve as basis for evaluation of texture and workmanship.
  - 1. Number of Mock-Ups to be Prepared: One.
  - 2. Use same materials and methods for use in the work.
  - 3. Use approved design samples as basis for mock-ups.
  - 4. Locate where directed.
  - 5. Minimum Size: 48 inches by 48 inches (1220 mm by 1220 mm).
- B. Obtain approval of mock-up by Architect before proceeding with work.

#### **1.07 MOCK-UP**

- A. Following review of complete submittals, Provide complete mock-up, 6 feet (\_\_\_ m) long by 6 feet (\_\_\_ m) wide, illustrating finish color and texture.
- B. Locate where directed.
- C. Mock-up may remain as part of the Work.

#### **1.08 DELIVERY, STORAGE, AND HANDLING**

- A. Store materials in a dry, secure area.
- B. Store materials for three days prior to installation in area of installation to achieve temperature stability.

#### **1.09 PROJECT CONDITIONS**

- A. Sequence cabinet base and wall finish installation prior to fluid flooring to enable installation of integral coved flooring base in a single operation.
- B. Coordinate fluid flooring installation with size, location and installation of service utilities.

#### **1.10 FIELD CONDITIONS**

- A. Maintain ambient temperature required by manufacturer 72 hours prior to, during, and 24 hours after installation of materials.

## **PART 2 PRODUCTS**

### **2.01 PERFORMANCE CRITERIA**

- A. VOC Limits for adhesives sealants, fillers, coatings and primers. Comply with limits specified in Section 01 6116.
- B. Comply with the following:
  - 1. Californian CDPH Standard Practice, also called Section 1350, often used for LEED IEQ specifications.
  - 2. Cradle to Cradle.
  - 3. FloorScore (resilient floorings, USA).
  - 4. Green Label by CRI (Carpets, adhesives, cleaners, USA).
  - 5. Indoor Advantage by SCS (USA).

### **2.02 Fluid-Applied Flooring SYSTEMS**

- A. Provide Fluid-Applied Flooring with specified adhesion to concrete floors at up to 100% Relative Humidity as measured by ASTM D 2170, in situ probe testing.
- B. Fluid-Applied Cork Flooring System, Type FF1: Vegetable oil, linseed oil, wood and cork powder, limestone, cork and other natural pigments, nominal 3/16 inch thickness.
  - 1. Products:
    - a. Verduren, [www.verduren.com](http://www.verduren.com)
    - b. Substitutions: See Section 01 6000 - Product Requirements.
  - 2. Free of chlorine and PVC.
  - 3. Free of plasticizers.
  - 4. Odor free.
  - 5. Antimicrobial.
  - 6. Binder: Biopolymer, linseed oil.
  - 7. Performance Criteria:
    - a. Tensile Strength: Appr. 20N/ mm<sup>2</sup>.
    - b. Compressive Strength: Appr. 20N/ mm<sup>2</sup>.
    - c. Mildew Resistance: No growth.
    - d. Adhesion in Shear (Bond) Strength: > 3N/mm<sup>2</sup> or failure of concrete bond minimum, when tested in accordance with ASTM D4541.
    - e. Impact Resistance: \_\_\_\_ in/lb (60 Nm); no cracking, chipping or delamination, when tested in accordance with ASTM D2794 or MILPRF24613.
    - f. Flammability: Self-Extinguishing (Class I) per ASTM E648.
    - g. Color: as indicated on the drawings.
    - h. VOC Content: 100 g/l or less.
    - i. Coefficient of Friction, Installed: 0.60 minimum, wet, measured in accordance with ASTM D2047.
- C. Topical Vapor Control Coating for Fluid Flooring: Type specified in Section 07 2633.

### **2.03 FINISHES**

- A. Color(s) as indicated on the plans.
- B. Multiple color selections will be required as shown on the Drawings. If none are shown, request from the Architect.

### **2.04 ACCESSORIES**

- A. Base caps: Type recommended by manufacturer for conditions required.
- B. Cant Strips: Molded of flooring resin material.

- C. Primer: Type recommended by manufacturer for substrate and body coats indicated.
- D. Patching and Fill Material: Resinous product of or approved by flooring manufacturer and recommended by manufacturer for application indicated.
- E. Sealant: manufacturer's recommended type, suitable for conditions required.
- F. Cleaners: Heavy-duty industrial detergent, manufacturer's recommended type, suitable for conditions required.
- G. Primers and Adhesives: Waterproof; types recommended by flooring manufacturer.

### **PART 3 EXECUTION**

#### **3.01 EXAMINATION**

- A. Cementitious Subfloors:
  - 1. Verify that substrates have been prepared and tested for moisture content and pH as specified in related sections.
  - 2. Verify preparation of substrate to specified flatness and levelness tolerances as specified in related sections.
  - 3. Verify substrate has been mechanically cleaned and surface profiled as specified in related sections.
- B. Verify that sub-floor surfaces are dust-free and free of substances that could impair bonding of materials to sub-floor surfaces.
- C. Verify that sub-floor surfaces are sloped to drain, free of ponding areas or conditions which would impair positive drainage when installation is complete. Flood-test with water to confirm free drainage.
- D. Verify that required floor-mounted utilities are in correct location.

#### **3.02 PREPARATION**

- A. Crack Repair: Repair concrete slab cracks as recommended, using materials recommended by the flooring manufacturer and included in their warranty. Quantity Allowance: One lineal foot of crack repair per square foot of floor installation.
- B. Apply, trowel, and float filler to achieve smooth, flat, hard surface with positive drainage configuration. Grind irregularities above the surface level. Prohibit traffic until filler is cured.
- C. Vacuum clean substrate.
- D. Apply primer to surfaces required by flooring manufacturer.
- E. Install topical vapor control coating for fluid flooring complete with primer and recommended accessories at all areas indicated to receive fluid-flooring.

#### **3.03 INSTALLATION - Accessories**

- A. Install cant strips at base of walls where flooring is to be extended up wall as base.
- B. Install terminating cap strip at top of base; install "H" or "T" channel configurations as required to suit specific conditions where wall panel finishes abut base; attach securely to wall substrate.

#### **3.04 INSTALLATION - FLOORING**

- A. Apply in accordance with manufacturer's instructions.

- B. Apply each coat to minimum thickness required by manufacturer, free from trowel marks, swirls, or imperfections. Completed mock-up shall serve as appearance and texture standard for completed work.
- C. Finish to smooth level surface with positive drainage as indicated. No ponding or birdbaths, all surface water flows to drain.
- D. Fillet and cove at vertical surfaces.
- E. Install sealants at perimeter and transition conditions in accordance with manufacturer's standard details and installation recommendations.

### **3.05 FIELD QUALITY CONTROL**

- A. Following manufacturer's recommended curing period, and prior to installation of further work, flood completed floor with water in presence of Owner's Inspector to verify positive drainage.
- B. Completed work shall exhibit positive drainage, free from ponding or "birdbaths", with uniform color and texture consistent with the granular character of the flooring material, free of "swirled" topcoat, with surface finish textures matching approved mockups.
- C. Immediately remove and replace work not conforming to these requirements.
- D. Adjust textures at no cost to Owner at locations where finish textures do not match approved mockups:

### **3.06 PROTECTION**

- A. Prohibit traffic on floor finish for 48 hours after installation.
- B. Barricade area to protect flooring until fully cured.

**END OF SECTION**

**SECTION 09 6813**  
**TILE CARPETING**

**PART 1 GENERAL**

**1.01 SECTION INCLUDES**

- A. Carpet tile, fully adhered.

**1.02 RELATED REQUIREMENTS**

- A. Section 01 6116 - Volatile Organic Compound (VOC) Content Restrictions.
- B. Section 01 8113 - Sustainable Design Requirements.
- C. Pertinent sections specifying Concrete Floor Preparation, Concrete Floor Moisture Content & pH Testing and Water Vapor Emission Control Coating (Moisture Mitigation System).

**1.03 REFERENCE STANDARDS**

- A. California Code of Regulations, Title 24, Part 2, California Building Code (CBC), International Building Code.
- B. California Code of Regulations, Title 24, Part 11 California Green Building Standards Code, "CAL-Green".
- C. CRI (GLP) - Green Label Plus Testing Program - Certified Products; [www.carpet-rug.org](http://www.carpet-rug.org); current edition.
- D. NFPA 253 - Standard Method of Test for Critical Radiant Flux of Floor Covering Systems Using a Radiant Heat Energy Source; 2015.

**1.04 SUBMITTALS**

- A. See Section 01 3300 - Submittals for submittal procedures.
- B. Provide complete submittals at the same time as submittals for work in related sections to permit review of complete and integrated systems and assemblies.
- C. Product Data: Provide data on specified products, describing physical and performance characteristics; sizes, patterns, colors available, and method of installation.
- D. CAL-GREEN Submittals:
  - 1. Product Data - VOC Limits: For adhesives sealants, fillers, primers and coatings, documentation including printed statement of VOC contents, comply with limits specified in related section.
  - 2. Product Data - Low Emitting Carpet: Provide certification that all carpet is certified CRI Green Label Plus. Refer to Section 01 6116.
- E. Samples: Submit two carpet tiles illustrating color and pattern design for each carpet color selected.
- F. Submit two, \_\_\_\_ inch (\_\_\_\_ mm) long samples of edge strip, base cap, stair nosing, and \_\_\_\_.
- G. Manufacturer's Installation Instructions: Indicate special procedures.
- H. Maintenance Data: Include maintenance procedures, recommended maintenance materials, and suggested schedule for cleaning.
- I. Maintenance Materials: Furnish the following for Owner's use in maintenance of project.
  - 1. See Section 01 6000 - Product Requirements, for additional provisions.



2. Extra Carpet Tiles: Quantity equal to 5 percent of total installed of each color and pattern installed.
3. All scraps of usable size left over from installation.

### 1.05 QUALITY ASSURANCE

- A. Manufacturer Qualifications: Company specializing in manufacturing specified carpet tile with minimum three years documented experience.
- B. Installer Qualifications: Company specializing in installing carpet tile with minimum three years documented experience and approved by carpet tile manufacturer.

### 1.06 FIELD CONDITIONS

- A. Store materials in area of installation for minimum period of 24 hours prior to installation.

## PART 2 PRODUCTS

### 2.01 PERFORMANCE REQUIREMENTS

- A. VOC Limits for adhesives, sealants, fillers, primers and coatings . Comply with limits specified in related section.
- B. Carpet Tiles: Manufactured in one color dye lot.
  1. Comply with Title 24, Part 11, 5.504.4.4; meet testing and product requirements of one of the following:
    - a. Carpet & Rug Institute "Green Label Plus".
    - b. California Department of Public Health Standard Practice for testing of VOC's (Specification 01350).
    - c. NSF/ANSI 140 at Gold Level.
    - d. Scientific Certification Systems Sustainable Choice.
  2. Fade Resistance:
    - a. Lightfastness - AATC 16E-1982 Dark Color; Gray scale rating of four or better after 180 standard fading hours as compared to AATC Gray Scale for evaluation change in color.
    - b. Ozone and Gas - AATCC 129-1298 - Rating 3 or better per color AATCC transference scale.
  3. Static Resistance: Provide carpet construction to provide a minimum of 3.0 KV resistance for 20% R. H. at 70 degrees, AATCC 134.
  4. Stain Resistance: Provide carpeting with permanent stain resistant properties which cannot be removed by wear or commercial cleanings. Pass Acid Red 40 spot test AATCC 175-1991 after removal of any topical treatments.
  5. Meet or exceed all flammability requirements of the California Building and Uniform Fire Code for floor covering.
    - a. Smoke Density.ASTM E-662 (NFPA 258) Less than 450.
    - b. Methenamine Tablet Test - DOC-FF-1-70 and/or ASTM D 2859-76. Carpet shall meet the "Standards for the Surface Flammability of Carpets"
    - c. Critical Radiant Flux (CRF): Minimum 0.45 watt per square centimeter, when tested in accordance with ASTM E 648 or NFPA 253.
  6. Static Coefficient of Friction: Provide products with the following values as determined by testing identical products per ASTM C 1028:
    - a. Level Surfaces: Minimum 0.6.
    - b. Sloped Surfaces: Minimum 0.8.
  7. Accessibility: Carpet shall conform to CBC Title 24, Chapter 11B.
    - a. Carpet and installation shall meet or exceed requirements of the American Disability Act.
    - b. Pile Height: ½ inch maximum.

- c. Securely attached to the floor and edges trimmed in compliance with California Building Code, Section 1124B.

## 2.02 MANUFACTURERS

- A. Tandus: [www.tandus.com](http://www.tandus.com).

## 2.03 SUBSTITUTIONS

- A. Substitutions: See Section 01600 - Product Requirements. In addition to all requirements of 01 6000, comply with the following.
  1. All proposed substitutions shall be submitted with detailed point-by-point comparisons to the performance requirements and other characteristics in the order listed in this specification. Enclose certified test reports demonstrating that carpet meets the tuft bind, static control, edge ravel, secondary backing delamination, stain resistance, CRI Green Label Certification and flammability properties specified.
  2. Names of (5) five installations that have been in use for ten (10) years using backing technology as specified, including contact names and phone numbers.
  3. All substitutions shall be approved only in writing.
- B. Product specifications, test reports, and other documents referenced in this section.
  1. All test results for proposed substitutions shall represent averages for production goods of the specified product.
- C. Two (2) 18 inch x 18 inch samples of proposed carpet.
- D. Two (2) twelve inch long pieces of proposed moldings and any and all special treatment materials.
- E. Substitutions not conforming to the above requirements will not be considered.

## 2.04 MATERIALS

- A. Carpet Style: "Abrasive Action#02578" manufactured by Tarkett/Tandus.
  1. Face Pile: Dynex SD® Nylon/ Dynex® Nylon with Ensure soil/stain protection.
  2. Pile thickness: 0.090 " (2.34 mm)
  3. Pile Height: 0.140 " (4 mm)
  4. Stitches/Rows per Inch: 9.60 /in
  5. Construction: Stratatec® Patterned Loop.
  6. Backing System: Ethos™ Modular composite with Fiberglass reinforced sealant.
    - a. Weight: 97.2 oz/sq yd.
    - b. Density: 65 lbs/cu ft.
    - c. Thickness: 0.050 inch.
    - d. 32.7 percent total recycled content (9.7 percent pre-consumer, 23 percent post-consumer).
  7. Color: As indicated on drawings
  8. Tile Size: 24 inches x 24 inches.
  9. Critical Radiant Flux: Conform to ASTM E 648, NFPA Class 1.
  10. Surface Flammability: Passes DOC-FF-1-70 Pill Test.
  11. Smoke Density: Less than 450 per NBS Smoke Chamber NFPA 258.
  12. Electrostatic Propensity: 1.5 kv.
  13. Adhesive System: Dry adhesive system or wet adhesive as recommended by manufacturer.
  14. CRI Green Label Plus Certified: Yes.
- B. Carpet Style: "Tomorrowland #42801" manufactured by Tarkett/Tandus.
  1. Face Pile: Dynex SD® Nylon/ Dynex® Nylon with Ensure soil/stain protection.
  2. Pile thickness: 0.115 " (2.92 mm)

3. Pile Height: 0.185 " (5 mm)
4. Stitches/Rows per Inch: 8 /in
5. Construction: Accuweave® Patterned Loop
6. Backing System: Ethos™ Modular composite with Fiberglass reinforced sealant.
  - a. Weight: 97.2 oz/sq yd.
  - b. Density: 65 lbs/cu ft.
  - c. Thickness: 0.050 inch.
  - d. 32.7 percent total recycled content (9.7 percent pre-consumer, 23 percent post-consumer).
7. Color: As indicated on drawings
8. Tile Size: 24 inches x 24 inches.
9. Critical Radiant Flux: Conform to ASTM E 648, NFPA Class 1.
10. Surface Flammability: Passes DOC-FF-1-70 Pill Test.
11. Smoke Density: Less than 450 per NBS Smoke Chamber NFPA 258.
12. Electrostatic Propensity: 1.5 kv.
13. Adhesive System: Dry adhesive system or wet adhesive as recommended by manufacturer.
14. CRI Green Label Plus Certified: Yes.

## 2.05 ACCESSORIES

- A. Edge Strips: Embossed aluminum, \_\_\_\_\_ color.
- B. Carpet Tile Adhesive: Recommended by carpet tile manufacturer; releasable type.
  1. Compatible with materials being adhered; maximum VOC content as specified in Section 01 6116.

## PART 3 EXECUTION

### 3.01 EXAMINATION

- A. All floors must be inspected by a manufacturer's representative prior to installation.
- B. Cementitious Subfloors:
  1. Verify that substrates have been prepared and tested for moisture content and pH as specified in related sections.
  2. Verify preparation of substrate to specified flatness and levelness tolerances.
  3. Verify installation of Water Vapor Emission Control Coating (Moisture Mitigation System Coating) as specified in related section is complete and ready to receive flooring.
- C. Correct unsatisfactory conditions prior to commencement. Start of work indicates acceptance of substrate.
- D. Verify that required floor-mounted utilities are in correct location.

### 3.02 INSTALLATION

- A. Starting installation constitutes acceptance of sub-floor conditions.
- B. Vacuum clean substrate.
- C. Install carpet tile in accordance with manufacturer's instructions.
- D. Blend carpet from different cartons to ensure minimal variation in color match.
- E. Cut carpet tile clean. Fit carpet tight to intersection with vertical surfaces without gaps.
- F. Lay carpet tile in square pattern, with pile direction parallel to next unit, set parallel to building lines.
- G. Locate change of color or pattern between rooms under door centerline.

- H. Trim carpet tile neatly at walls and around interruptions.
- I. Complete installation of edge strips, concealing exposed edges.

**3.03 CLEANING**

- A. Stockpile usable scraps of carpet in designated location for Owner's use.
- B. Remove excess adhesive without damage, from floor, base, and wall surfaces.
- C. Clean and vacuum carpet surfaces.
- D. Protect from damage until acceptance. Replace damaged materials as required for unblemished appearance.

**END OF SECTION**

**SECTION 09 7230**  
**TACKABLE WALL COVERING**

**PART 1 GENERAL**

**1.01 SECTION INCLUDES**

- A. Tackable Wall Covering .
  - 1. Fiber Wall Covering.
  - 2. Linoleum Wall Covering.

**1.02 RELATED REQUIREMENTS**

- A. Section 01 6116 - Volatile Organic Compound (VOC) Content Restrictions.
- B. Section 01 8113 - Sustainable Design Requirements.
- C. Section 09 2116 - Gypsum Board Assemblies: Wall substrates.
  - 1. Filling of gaps and fastener depression in substrates.
- D. Section 09 9123 - Interior Painting: Preparation and priming of substrate surfaces.

**1.03 REFERENCE STANDARDS**

- A. Manufacturer's recommendations for installation.
- B. ASTM E84 - Standard Test Method for Surface Burning Characteristics of Building Materials; 2015a.
- C. California Code of Regulations, Title 24, Part 2, California Building Code (CBC), International Building Code.
- D. California Code of Regulations, Title 24, Part 11, California Green Building Standards Code, "CAL-Green".

**1.04 SUBMITTALS**

- A. See Section 01 3300 - Submittals, for submittal procedures.
- B. Provide complete submittals at the same time as submittals for work in related sections to permit review of complete and integrated systems and assemblies.
- C. Product Data: Provide data on wall covering, fillers, sealers and adhesive.
  - 1. Include data on physical properties, fire hazard classification and characteristics of wall coverings.
  - 2. Include manufacturer's recommendations for maximum permissible moisture content of substrates.
- D. CAL-GREEN Submittals: Product Data - VOC Limits: For adhesives sealants, fillers, primers and coatings, documentation including printed statement of VOC contents, comply with limits specified in related section.
- E. Shop Drawings: Indicate wall elevations with seaming layout.
- F. Samples: Submit two samples of wall covering, 7 inches by 9 inches in size illustrating color, finish, and texture.
- G. Test Reports: Indicate verification of flame and smoke ratings, when tested by UL.
- H. Manufacturer's Installation Instructions: Indicate special procedures.
- I. Maintenance Data: Submit data on cleaning, touch-up, and repair of covered surfaces.
- J. Manufacturer's Qualification Statement.

- K. Installer's Qualification Statement.
- L. Maintenance Materials: Furnish the following for Owner's use in maintenance of project.
  - 1. See Section 01 6000 - Product Requirements, for additional provisions.
  - 2. Extra Wall Covering Materials: 25 linear feet (8 linear m) of each color and pattern of wall covering; store where directed.
  - 3. Package and label each roll by manufacturer, color and pattern, and destination room number.

#### **1.05 QUALITY ASSURANCE**

- A. Manufacturer Qualifications: Company specializing in manufacturing products specified in this section with minimum three years of documented experience.
- B. Installer Qualifications: Company specializing in performing work of the type specified and with at least three years of documented experience.

#### **1.06 MOCK-UP**

- A. Provide panel, 3 panel drops wide, minimum, including an inside and outside corner, full height, illustrating installed wall covering.
- B. Locate where directed.
- C. Replace unacceptable panels as directed. Retain accepted panels as the standard of comparison for the Work.
- D. Mock-up may remain as part of the Work.

#### **1.07 DELIVERY, STORAGE, AND HANDLING**

- A. Inspect roll materials at arrival on site, to verify acceptability.
- B. Protect packaged adhesive from temperature cycling and cold temperatures.
- C. Do not store roll goods on end.

#### **1.08 FIELD CONDITIONS**

- A. Do not apply materials when surface and ambient temperatures are outside the temperature ranges required by the adhesive or wall covering product manufacturer.
- B. Maintain these conditions 72 hours before, during, and after installation of adhesive and wall covering.
- C. Provide lighting level of 80 ft candles (860 lx) measured mid-height at substrate surfaces for installation and viewing of mock-ups.
- D. Ventilation: Provide continuous ventilation during installation and for not less than the time recommended by the wall covering manufacturer for full drying or curing.

### **PART 2 PRODUCTS**

#### **2.01 PERFORMANCE REQUIREMENTS**

- A. VOC Limits for adhesives, sealants, fillers, primers and coatings . Comply with limits specified in related section.
  - 1. VOC concentration: 0.009 mg/m<sup>3</sup> (7 days). Free of formaldehyde binders.
- B. Surface Burning Characteristics: Class 1 or A, ASTM E84.Flame spread/Smoke developed index of 25/450, maximum.
- C. Extend wall coverings behind surface mounted trim plates.

- D. Produce hairline seams at all locations which exhibit no edge ravel.
- E. Produce installation which is uniformly flat with no ridges or folds.
- F. Moisture Absorption: Less than 0.03% by weight when exposed to an atmosphere of 122F at 90% relative humidity for four days. Will not rot or deteriorate in intended use conditions.
- G. All wall coverings shall contain a minimum of 45 percent recycled content.
- H. Colors selected by Architect from manufacturer's full range of available colors, minimum selection of 38 colors. Color schemes will include two selections per room, of roughly equal proportions, colors and locations to be field determined by Architect.

## **2.02 TACKABLE LINOLEUM WALL COVERINGS**

- A. Tackable Linoleum Wall Coverings: Acceptable Products.
  - 1. Forbo Bulletin Board®; [www.forbo-flooring.com](http://www.forbo-flooring.com).
  - 2. Substitutions: See Section 01 6000 - Product Requirements.
- B. Tackable Linoleum Wall Covering: Uni-color resilient homogeneous tackable linoleum surface consisting of linseed oil, granulated cork, rosin binders, and dry pigments calendered onto natural burlap backing. Color shall extend through thickness of material.
  - 1. ASTM E84: Class II (B).
  - 2. Thickness (gauge): 6 mm.
  - 3. Color: As noted on Drawings. Matte Sheen.
  - 4. Straight Match, Reverse Hang.
  - 5. Certifications:
    - a. California IAQ-01350.
- C. Include J-cap low-profile trim.

## **2.03 ACCESSORIES**

- A. Adhesive: Type recommended by wall covering manufacturer to suit application to substrate, manufactured expressly for use with the selected wall covering. Provide materials that contain mildew inhibitors that are nonstaining to the wall-covering.
- B. Termination Trim: Wall covering manufacturer's recommended type to suit application.
- C. Mechanical fasteners: Type recommended by wall covering manufacturer, length as required for 2 inch minimum penetration of supporting framing.
- D. Substrate Primer and Sealer: Type specified in Section 09 9123.

## **2.04 FINISHES**

- A. Color(s) as selected by Architect from:
  - 1. Manufacturer's full range of standard colors.
- B. Multiple color selections will be required as shown on the Drawings. If none are shown, request from the Architect.

## **2.05 SOURCE QUALITY CONTROL**

- A. Color Match: Each type and color produced from a single dye lot.

## **PART 3 EXECUTION**

### **3.01 EXAMINATION**

- A. Verify that substrate surfaces are ready to receive work, and conform to requirements of the wall covering manufacturer.

1. Verify that cracks and fastener depressions in substrate are filled as specified in related section 09 2116 - Gypsum Board Assemblies, so that surface is flat to a tolerance of 1/8-inch in 10 feet, and 1/16 inch in 1 foot with irregularities filled and sanded smooth.
  2. Verify that substrate surfaces are primed with appropriate primer as specified in related section 09 9123 - Interior Painting.
- B. Measure moisture content of surfaces using an electronic moisture meter. Do not apply wall coverings if moisture content of substrate exceeds level recommended by wall covering manufacturer.
- C. Evaluate all painted surfaces for the possibility of pigment bleed-through. Recommend corrective measures where bleed-through may occur.
- D. Correct unsatisfactory conditions prior to commencement of work.
- E. Schedule installation of wall covering as late as possible in the construction schedule to prevent damage during construction and movement of materials.
- F. Verify that materials have been supplied as ordered, free from damage or faults. Check fabric color and product labels to ensure product has been supplied correctly.
1. Where multiple rolls are required, verify that all products are supplied from one batch and that the roll numbers are sequential. Do not join different batch lots as this could result in color variation due to batch to batch variations.
- G. Inspect wall covering for defects. Do not install defective wall covering. Notify Owner's representative of any defects immediately.
1. Notify the Owner's Representative of variations in color or pattern match. Do not continue with work until instructed by Owner's Representative.

### 3.02 PREPARATION

- A. Wash impervious surfaces with tri-sodium phosphate, rinse and neutralize; wipe dry.
- B. Gloss and semi-gloss substrate finishes should be lightly sanded and dusted clean prior to application of the adhesive.
- C. Surface Appurtenances: Remove or mask electrical plates, hardware, light fixture trim, escutcheons, and fittings prior to preparing surfaces or finishing.
- D. Surfaces: Correct defects and clean surfaces that affect work of this section. Remove existing coatings that exhibit loose surface defects.
- E. Marks: Seal with shellac those that may bleed through surface finishes.
- F. Vacuum clean surfaces free of loose particles.
- G. All surfaces must be clean, dust-free and dry. Dust and moisture will adversely affect the adhesive and may result in lack of adhesion.

### 3.03 INSTALLATION

- A. Conditioning: Open rolls and permit material to "relax" for at least 24 hours before application.
- B. Lay out materials in color lot sequence. Avoid contrasts between rolls.
- C. Autex Composition™ has a pile and must be installed with the fabric pile running in the same direction to avoid the appearance of colour variations. The pile direction is marked by arrows on the back of the product. Autex recommends that the pile runs down.



- D. Adhesives should be applied strictly in accordance with the adhesive manufacturer's instructions. Refer to the product label or the technical datasheet for spread rates, tack-off times, application methods and equipment required.
  - 1. Apply adhesive and wall covering to achieve fully adhered application to substrate.
  - 2. Apply adhesive to wall surface immediately prior to application of wall covering.
- E. Autex Composition™ is designed to be butt-joined. If using Rigid Profiles, these should be installed before adhering the wall covering to the wall. A width of wall covering can be used to accurately measure where the H-Section/ Joiner Profiles are to be fixed. When applying the adhesive, ensure there is a 2.75 inch gap to each side of the Profiles to allow for tucking in.
- F. Autex Composition™ must be hung from the top down, smoothing outwards while maintaining pressure towards joints. Immediately after the drop is hung and in the correct position, roll with a hand roller to ensure adequate transfer of adhesive and a strong bond is formed. Roll drops towards the butt-joints first, then roll the entire drop. Small wallpaper and vinyl rollers must not be used. A wide roller approximately 3.93 - 5.90 inches wide is ideal.
- G. Install each roll in sequence starting from the highest to the lowest number and each strip in the same sequence as cut from the roll. Avoid excessive variation in color match, as defined by the Architect at the time of mock-up review.
- H. Cut wall-covering panels in roll number sequence. Change run numbers at partition breaks and corners only. Install wall covering with no gaps or overlaps. Match pattern 72 inches above finish floor. Trim edges for color uniformity, pattern match, and tight closure at seams and edges. Double cut seams.
  - 1. Install non-match panels on the hanging surface, reversing every other panel unless otherwise recommended by the manufacturer. Match side joints for continuity.
  - 2. Fill in over doors and windows as work progresses with panels cut in consecutive order from the roll.
  - 3. Do not allow vertical joints to occur closer than 6 inches from outside corners not indicated to receive new corner guards.
    - a. Use outside corners receiving corner guards to adjust wall-covering needing realignment due to "out-of-plumb" walls.
  - 4. Notify the Owner's Representative immediately of variations in color or pattern match. Do not continue with work until instructed by the Owner's Representative.
- I. Razor trim edges on flat work table. Do not razor cut on gypsum board surfaces.
- J. Apply wall covering smooth, without wrinkles, gaps or overlaps. Eliminate air pockets and ensure full bond to substrate surface.
- K. Joints shall be vertical, clean and flat with no gaps or visible compression marks. Adhesive spills or fabric surface contamination must be cleaned immediately strictly following the Autex Interior Acoustics Care & Maintenance Guide instructions.
- L. Horizontal seams are not acceptable.
- M. Do not seam within 6 inches (\_\_\_ mm) of internal corners or within 6 inches (150 mm) of external corners.
- N. Install wall covering before installation of bases and items attached to or spaced slightly from wall surface.
- O. Cover spaces above and below windows, above doors, in pattern sequence from roll.
- P. Install termination trim at unprotected or exposed edges, where wall covering terminates, and where indicated.

- Q. Remove excess adhesive while wet from seam before proceeding to next wall covering sheet. Wipe clean with dry cloth.
  - 1. Clean off residues of adhesives in the manner recommended jointly by the adhesive and wallcovering manufacturer. Test cleaning agent on a scrap of the vinyl tackboard before use and assure that cleaning agent will not harm finished surface.

#### **3.04 CLEANING AND ADJUSTING**

- A. Clean wall coverings of excess adhesive, dust, dirt, and other contaminants.
- B. Reinstall wall plates and accessories removed prior to work of this section.
- C. Replace areas with poor color match as directed.
- D. Apply color-matched sealant as specified in Section 07 9200 at transitions where wall covering adjoins other materials.
- E. Replace damaged or marked elements.
- F. Clean adjoining surfaces of any adhesive. Remove debris, unused materials and waste from site.
- G. Completed work shall be secure, smooth and free of air bubbles, wrinkles, gaps, stains and blemishes.

#### **3.05 PROTECTION**

- A. Do not permit construction activities at or near finished wall covering areas.
- B. Replace damaged work prior to occupancy.

**END OF SECTION**

## **SECTION 09 7723**

### **WALL PANELS**

#### **PART 1 GENERAL**

##### **1.01 SECTION INCLUDES**

- A. Fabric-Wrapped Tackboard Paneling, factory fabricated.
- B. Trim and installation accessories.

##### **1.02 RELATED SECTIONS**

- A. Section 01 6116 - Volatile Organic Compound (VOC) Content Restrictions.
- B. Section 01 8113 - Sustainable Design Requirements.
- C. Sections specifying products serving as substrates for wall panels.
- D. Pertinent sections of other Divisions specifying work penetrating wall panels.
- E. California Code of Regulations, Title 24, Part 2, California Building Code (CBC), International Building Code.
- F. California Code of Regulations, Title 24, Part 11, California Green Building Standards Code, "CAL-Green".

##### **1.03 REFERENCES**

- A. ASTM E 84 - Standard Test Method for Surface Burning Characteristics of Building Materials; 1997a.

##### **1.04 SUBMITTALS**

- A. See Section 01 3300 - Submittals, for submittal procedures.
- B. Product Data: Provide manufacturer's standard details and catalog data demonstrating compliance with referenced standards. Provide installation instructions.
- C. CAL-GREEN Submittals:
  - 1. Product Data - VOC Limits: For adhesives sealants, fillers, primers and coatings, documentation including printed statement of VOC contents, comply with limits specified in related section..
- D. Shop Drawings: Indicate wall elevations showing joint layout and items penetrating panels, such as switches, thermostats, fire alarm stations and similar items. Provide at same size, scale and using same Room Identification as contract drawings.
- E. Samples:
  - 1. Submit 6 inch (300 mm) square samples of each surface and color required.
  - 2. Submit 6 inch (300 mm) long samples of each trim profile and trim color required.
- F. Manufacturer's Installation Instructions: Indicate special procedures.
- G. Test Reports: For substrate boards, indicate conformance to specified requirements and referenced standards.

##### **1.05 DELIVERY, STORAGE, AND HANDLING**

- A. Store products indoors and protect from moisture, construction traffic, and damage.
- B. Store panels flat on clean, dry surface. Do not stand on edge or stack on fresh concrete or other surfaces that emit moisture.

- C. Store panels for at least 24 hours at temperature and humidity conditions approximating the average environment of the finished room.

**1.06 MOCK-UP**

- A. Provide mock-up, 3 panel drops wide, minimum, including an inside and outside corner, full height, illustrating installed wall covering.
- B. Locate where directed.
- C. Replace unacceptable panels as directed. Retain accepted panels as the standard of comparison for the Work.
- D. Mock-up may remain as part of the Work.

**1.07 AMBIENT CONDITIONS**

- A. Do not apply materials when surface and ambient temperatures are outside the temperature ranges required by the adhesive or wall panel product manufacturer.
- B. Maintain these conditions 72 hours before, during, and after installation of adhesive and wall covering.
- C. Provide lighting level of 80 ft candles (860 lx) measured mid-height at substrate surfaces for installation and viewing of mock-ups.
- D. Ventilation: Provide continuous ventilation during installation and for not less than the time recommended by the wall covering manufacturer for full drying or curing.

**1.08 EXTRA MATERIALS**

- A. See Section 01 6000 - Product Requirements, for additional provisions.
- B. Supply five percent of installed area of each material and color for Owner 's use in maintenance of project.

**PART 2 PRODUCTS**

**2.01 PERFORMANCE REQUIREMENTS**

- A. VOC Limits for adhesives, sealants, fillers, primers and coatings . Comply with limits specified in related section.
- B. Produce hairline joints at all locations.
- C. Produce wrapped fabric installation which is uniformly flat with no ridges, "mole trail" or folds.

**2.02 FIBERGLASS REINFORCED COMPOSITE PANELS**

- A. General: Fiberglass reinforced composite panels.
  - 1. Composite plastic panels of random chopped fiber glass roving, modified polyester copolymer, inorganic fillers, and pigments.
  - 2. Resistant to rot, corrosion, staining, denting, peeling, and splintering.
  - 3. USDA accepted.
  - 4. Comply with ASTM D 3841, Type CC2.
- B. Sequentia Structoglas FRP Wall and Ceiling Panels; "FRFRJ/FX".
  - 1. Surface burning classification: Class A.
    - a. Flame spread (ASTM E 84): 25 or less.
    - b. Smoke developed (ASTM E 84): 450 or less.
  - 2. Flexural Strength (ASTM D 790): 13,600 psi.

3. Flexural Modulus (ASTM D 790): 250,000 psi.
  4. Tensile Strength (ASTM D 638): 7,100 psi.
  5. Tensile Modulus (ASTM D 638): 920,000 psi.
  6. Impact Strength, IZOD (ASTM D 256): 12 ft-lb/in notched.
  7. Coefficient of Linear Thermal Expansion (ASTM D 696): 0.000017 in/in/degree F.
  8. Barcol Hardness (ASTM D 2583): 40.
  9. Water Absorption (ASTM D 570): 0.32 percent in 24 hrs. @ 77 degrees F (25 degree C).
- C. Sequentia Structoglas FRP Wall and Ceiling Panels; "FTSTF".
1. Surface burning classification: Class C.
    - a. Flame spread (ASTM E 84): 200 or less.
    - b. Smoke developed (ASTM E 84): 450 or less.
  2. Flexural Modulus (ASTM D 790): 250,000 psi.
  3. Tensile Modulus (ASTM D 638): 500,000 psi.
  4. Impact Strength, IZOD (ASTM D 256): 4 ft-lb/in notched.
  5. Coefficient of Linear Thermal Expansion (ASTM D 696): 0.0000225 in/in/degree F.
  6. Water Absorption (ASTM D 570): 0.75 percent in 24 hrs. @ 77 degrees F (25 K).
- D. Size:
1. Wall panel width: 48 inches (1.22 m).
  2. Wall panel length: Provide full-length panels unless substrate dimensions exceed available fabricated size.
  3. Ceiling panel width: 23-3/4 inches (603 mm).
  4. Ceiling panel length: 47-3/4 inches (1213 mm).
  5. Thickness:
  6. Dimensional Tolerances:
    - a. Width and length: +/- 1/8 inch (3.2 mm).
    - b. Thickness: +/- 10 percent.
    - c. Squareness: Not more than 1/8 inch (3.2 mm) out of square.
- E. Finishes:
1. Exposed Surface: embossed pebbled textured finish.
  2. Back Surface: Smooth. Imperfections that do not affect functional properties are not cause for rejection.
  3. Color: As selected from manufacturer's standard colors, uniform throughout.
- F. Manufacturers:
1. Crane Composites; 23525 W Eames, Channahon, IL 60410; [www.cranecomposites.com](http://www.cranecomposites.com)
  2. Marlite; 15120 Marquardt Ave., Santa Fe Springs, CA 90670; [www.marlitefrp.com](http://www.marlitefrp.com)
  3. Substitutions: See Section 01 6000 - Product Requirements.

## 2.03 ACCESSORIES

- A. Fasteners: Non-staining, as recommended by manufacturer in writing.
  1. Length to suit project conditions.
- B. Adhesive: Structural construction adhesive as recommended by manufacturer, meeting or exceeding specified fire code criteria.
- C. Sealant: Color-matched sealant as recommended by manufacturer. Clear sealant not permitted.

## 2.04 FINISHES

- A. Color(s) as selected by Architect from:
  1. Manufacturer's full range of standard colors.

- B. Multiple color selections will be required as shown on the Drawings. If none are shown, request from the Architect.

### **PART 3 EXECUTION**

#### **3.01 EXAMINATION**

- A. Examine substrates that will receive panels to ensure that surfaces are smooth, dry, true, and free of dirt, dust, oil, or grease.
- B. Remove high spots. Fill low spots.
- C. Verify that substrate construction is completed and approved.
- D. Correct deficiencies in substrate before installing panels.
- E. Allow panels to acclimate to the moisture and temperature in the room environment prior to installation, and in accordance with manufacturer's limitations.

#### **3.02 INSTALLATION - TACKABLE PANELS**

- A. Fit fabric-wrapped tackboard panels and mechanically secure in place, free from damaged edges or other defects detrimental to appearance and function.
- B. Securely fasten wall panels in vertical orientation in patterns and configurations indicated with adhesives and concealed screws at top and bottom of panels. Space fasteners as specified for panel materials in Section 09 2116.
- C. Install in uniform plane matching flatness tolerance of completed substrates specified in other sections, free from twists, warps, stains, tears, dents, damaged edges or defects impairing appearance or function.
- D. Razor-cut all panel edges, do not "score-and-break". Back-wrap and adhere fabric at all cut panel edges, no exposed panel substrate materials or substrates visible in finished work.
- E. Install fabric-wrapped metal termination trim at edges where indicated and wherever acceptable back-wrapped self-edges cannot be made.
- F. Sealants: Seal corner seams, ceiling and base junctures, around door frames and other openings, perimeters of fire protection cabinets and similar items, and between penetrating items and panel cut-outs with color-matched sealant.

#### **3.03 INTERFACE WITH OTHER WORK**

- A. Cut panels neatly to allow penetrations for switches, thermostats, fire alarms and similar wall-mounted elements that may occur in the field of the panels. Trim out penetration openings using same techniques as for panel edges. Ensure openings are sized to permit hairline gaps to be sealed to the penetrating items, or otherwise sized to ensure gaps are completely covered by escutcheons or cover plates on the penetrating item.

#### **3.04 ADJUST AND CLEAN**

- A. Remove scraps and debris from the site, and leave in a neat and clean condition.
- B. Protect installed Work from subsequent construction operations.

**END OF SECTION**

**SECTION 09 8420**  
**WOOD FIBER ACOUSTICAL WALL PANELS**

**PART 1 GENERAL**

**1.01 SECTION INCLUDES**

- A. Section specifies mechanically fastened, wood fiber acoustical panels..

**1.02 RELATED SECTIONS**

- A. Pertinent Sections specifying Volatile Organic Compound (VOC) Content Restrictions.
- B. Section 01 8113 - Sustainable Design Requirements.
- C. Section 06 1000 - Rough Carpentry.
- D. Section 06 2000 - Finish Carpentry.
- E. Section 09 5100 - Suspended Acoustic Ceilings.
- F. Section 09 5153 - Adhesive Applied Acoustic Ceilings.
- G. Divisions 23 and 26: Pertinent sections specifying mechanical and electrical work in walls.

**1.03 REFERENCES**

- A. ASTM E 84 - Standard Test Method for Surface Burning Characteristics of Building Materials.
- B. California Code of Regulations, Title 24, Part 2, California Building Code (CBC), International Building Code.
- C. California Code of Regulations, Title 24, Part 11, California Green Building Standards Code, "CAL-Green".

**1.04 SUBMITTALS**

- A. Product Data: Provide data on acoustical units.
- B. CAL-GREEN Submittals:
- C. Shop Drawings: Indicate mounting method and fastener spacing.
- D. Samples: Submit two samples, 6 x 6 inch (\_\_\_\_x\_\_\_\_ mm) in size, illustrating material and finish of acoustic units.
- E. Manufacturer's Instructions: Indicate special procedures and perimeter conditions.

**1.05 QUALITY ASSURANCE**

- A. Manufacturer Qualifications: Company specializing in manufacturing products specified in this section, with not less than five years of documented experience.
- B. Installer Qualifications: Company specializing in performing the work of this section with minimum three years of documented experience.

**1.06 MOCK-UP**

- A. Provide complete mock-up, 8 feet (\_\_\_\_ m) long by 12 feet (\_\_\_\_ m) wide, illustrating finished system.
- B. Locate where directed.
- C. Mock-up may remain as part of the Work.

### **1.07 PROJECT CONDITIONS**

- A. Sequence work to ensure acoustical panels are not installed until building is enclosed, sufficient heat is provided, dust generating activities have terminated, and overhead work is completed, tested, and approved.
- B. Install acoustical panels after interior wet work is dry.

### **1.08 AMBIENT REQUIREMENTS**

- A. Maintain uniform interior temperature of minimum 60 degrees F, and maximum humidity of 40 percent prior to, during, and after installation.
- B. Materials shall be stored at the location where they are to be installed for twenty-four hours minimum prior to application to allow adjustment to temperature and humidity conditions.

### **1.09 EXTRA MATERIALS**

- A. See Section 01 6000 - Product Requirements, for additional provisions.
- B. Supply five acoustic panels for Owner 's use in maintenance of project.

## **PART 2 PRODUCTS**

### **2.01 PERFORMANCE REQUIREMENTS**

- A. Composite Wood products must meet current CARB Airborne Toxic Control Measure (ATCM) for Composite Wood Formaldehyde Limits by Mandatory Compliance Dates as specified in Section 01 6116.
- B. Conform to applicable code for fire rated assembly and combustibility requirements for materials.
- C. Flame / Smoke Properties (in accordance with ASTM E84.):
  - 1. Flame Spread: 0-25
  - 2. Smoke Density: 0-450.

### **2.02 WOOD FIBER ACOUSTIC PANELS**

- A. Manufacturers:
  - 1. Tectum, Newark OH, 614-345-9691, [www.tectum.com](http://www.tectum.com)
- B. Acoustical panels - Wood Fiber Cementitious: Tectum "Standard";
  - 1. Material: Aspen wood fibers bonded with inorganic hydraulic cement.
  - 2. Size: As indicated on drawings.
  - 3. Thickness: As indicated, minimum 1 inch.
  - 4. Surface finish: "Image" Multiple color factory painted.
    - a. Color as selected by Architect from manufacturer's full range of available colors including premium choices.
  - 5. Edge: Square, accommodating standard internal spline mounting system.
  - 6. NRC .80 for mounting method indicated.
  - 7. Fire rating: Class A flame spread.

### **2.03 FINISHES**

- A. Multiple color selections will be required as shown on the Drawings. If none are shown, request from the Architect.

### **2.04 ACCESSORIES**

- A. Mechanical fasteners: Type recommend by manufacturer, length as required for 2" minimum penetration of substrate, painted finish.



B. Vinyl spline for kerfed panel installation: panel manufacturer's standard.

C. Acoustic Insulation: OCF 703 fiberglass insulation, panel manufacturer's recommended type.

### **PART 3 EXECUTION**

#### **3.01 EXAMINATION**

A. Verify that substrates are ready to receive work.

#### **3.02 INSTALLATION**

A. Install in accordance with manufacturer's instructions.

1. In uniform plane, free from twist, warp or dents.

B. Locate panels as indicated and scheduled.

C. Fit acoustical panels in place, free from damaged edges or other defects detrimental to appearance and function.

1. Mechanically secure each acoustical panel.

2. Mount over 1" nominal furring strips and fiberglass acoustic insulation per manufacturer's standard method C-20.

D. See Section 06 2000 - Finish Carpentry for installation of wood trim, shims and backing.

#### **3.03 ERECTION TOLERANCES**

A. Maximum Variation From True Position: 1/8 inch in 10 feet.

#### **3.04 CLEANING and PROTECTION**

A. Clean acoustic panels. Replace all panels that cannot be returned to new appearance.

B. Protect installed work from subsequent construction operations.

**END OF SECTION**

**SECTION 09 8430**  
**SOUND-ABSORBING WALL AND CEILING UNITS**

**PART 1 GENERAL**

**1.01 SECTION INCLUDES**

- A. Sound-absorbing panels, adhesively attached.

**1.02 RELATED REQUIREMENTS**

- A. Pertinent Sections specifying Volatile Organic Compound (VOC) Content Restrictions.

**1.03 REFERENCE STANDARDS**

- A. ASTM E84 - Standard Test Method for Surface Burning Characteristics of Building Materials; 2015a.
- B. California Code of Regulations, Title 24, Part 2, California Building Code (CBC), International Building Code.
- C. California Code of Regulations, Title 24, Part 11, California Green Building Standards Code, "CAL-Green".

**1.04 SUBMITTALS**

- A. See Section 01 3000 - Administrative Requirements, for submittal procedures.
- B. Product Data: Manufacturer's printed data sheets for products specified.
- C. CAL-GREEN Submittals: Product Data - VOC Limits: For adhesives sealants, fillers, primers and coatings, documentation including printed statement of VOC contents, comply with limits specified in related section.
- D. Shop Drawings: Fabrication and installation details, panel layout, and fabric orientation.
- E. Selection Samples: Manufacturer's color charts for fabric covering, indicating full range of fabrics, colors, and patterns available.
- F. Maintenance Materials: Furnish the following for Owner's use in maintenance of project.
  - 1. See Section 01 6000 - Product Requirements, for additional provisions.
  - 2. Extra Panels: Quantity equal to 5 percent of total installed, but not less than one of each type.

**1.05 DELIVERY, STORAGE, AND HANDLING**

- A. Protect acoustical units from moisture during shipment, storage, and handling. Deliver in factory-wrapped bundles; do not open bundles until units are needed for installation.
- B. Store units flat, in dry, well-ventilated space; do not stand on end.
- C. Protect edges from damage.

**1.06 MOCK-UP**

- A. See Section 01 4000 - Quality Requirements, for additional mock-up requirements.
- B. Construct mock-up of acoustical units at location as indicated by Architect.
  - 1. Minimum mock-up dimensions; 96 by 96 inches (2440 by 2440 mm).
  - 2. Approved mock-up may remain as part of the Work.

## **PART 2 PRODUCTS**

### **2.01 PERFORMANCE REQUIREMENTS**

- A. VOC Limits for adhesives, sealants, fillers, primers and coatings . Comply with limits specified in related section.

### **2.02 SOUND-ABSORBING UNITS**

- A. Sound Absorbing Units for Walls and Ceilings: 100 percent polyester panels with digital print patterns.
  - 1. Surface Burning Characteristics: Class A when tested in accordance with ASTM E84.
  - 2. Zero VOC, no formaldehyde.
  - 3. Sizes and Thickness: As indicated on the Drawings, 1/2 inch minimum.
  - 4. Acoustic Rating: 0.45 - 0.90 NRC depending on thickness.
  - 5. Colors and Patterns: As indicated on drawings.
  - 6. MDC Wall, Zintra; [www.mdcwall.com](http://www.mdcwall.com).
    - a. Substitutions: See Section 01 6000 - Product Requirements.

### **2.03 ACCESSORIES**

- A. Panel Adhesive: Acceptable to acoustical panel manufacturer for application as indicated and meeting VOC requirements in related section.

## **PART 3 EXECUTION**

### **3.01 EXAMINATION**

- A. Examine substrates for conditions detrimental to installation of acoustical units. Proceed with installation only after unsatisfactory conditions have been corrected.

### **3.02 INSTALLATION**

- A. Install acoustical units in locations as indicated, following manufacturer's installation instructions.
- B. Align panels accurately, with edges plumb and top edges level. Scribe to fit accurately at adjoining work and penetrations.
- C. Install acoustical units to construction tolerances of plus or minus 1/16 inch (1.6 mm) for the following:
  - 1. Plumb and level.
  - 2. Flatness.
  - 3. Width of joints.

### **3.03 CLEANING**

- A. Clean fabric facing upon completion of installation from dust and other foreign materials, following manufacturer's instructions.

### **3.04 PROTECTION**

- A. Provide protection of installed acoustical panels until Date of Substantial Completion.
- B. Replace panels that cannot be cleaned and repaired to satisfaction of the Architect.

**END OF SECTION**

**SECTION 09 8448**  
**METAL-FACED ACOUSTICAL PANELS**

**PART 1 GENERAL**

**1.01 SECTION INCLUDES**

- A. Perforated and un-perforated metal wall panels
- B. Acoustical backing.
- C. Suspension assemblies
- D. Accessories; provide other necessary items including devices for attachment overhead construction, secondary members, splines, splices, connecting clips, wall connectors, trims, and other devices required for a complete installation.
- E. Supplemental support framing: Provide fully engineered secondary framing as required to meet code, conforming to layout shown in drawings, to support metal wall suspension system.
- F. Reinforced corner wall trim: Provide fully engineered, reinforced corner wall trim in 1/16" thickness and custom profile; finished to match adjacent wall panels. Or as otherwise noted in the drawings.
- G. Coordinate layout and installation of items penetrating or being installed into wall systems with responsible trades.

**1.02 RELATED REQUIREMENTS**

- A. Section 01 6116 - Volatile Organic Compound (VOC) Content Restrictions.
- B. Section 01 8113 - Sustainable Design Requirements.
- C. Section 06 2000 - Finish Carpentry.
- D. Pertinent sections specifying work penetrating metal-faced panel assemblies.

**1.03 REFERENCE STANDARDS**

- A. ASTM C423 - Standard Test Method for Sound Absorption and Sound Absorption Coefficients by the Reverberation Room Method; 2009a.
- B. ASTM E84 - Standard Test Method for Surface Burning Characteristics of Building Materials; 2015a.
- C. California Code of Regulations, Title 24, Part 2, California Building Code (CBC), International Building Code.
- D. California Code of Regulations, Title 24, Part 11 California Green Building Standards Code, "CAL-Green".

**1.04 SUBMITTALS**

- A. See Section 01 3300 - Submittals, for submittal procedures.
- B. Product Data: Manufacturer's printed data sheets for products specified.
- C. CAL-GREEN Submittals:
  - 1. Product Data - VOC Limits: For adhesives, sealants, fillers, primers and coatings, documentation including printed statement of VOC contents, comply with limits specified in related section.

2. Composite Wood Formaldehyde Limits: Provide certification that all products meet current CARB Airborne Toxic Control Measure (ATCM) for Composite Wood Formaldehyde Limits by Mandatory Compliance Dates as specified in related section.
- D. Shop Drawings: Fabrication and installation details, panel layout on wall elevations, panel pattern and type.
  1. Include location of wall-mounted items and work penetrating panels, such as lighting, fire alarm and similar items.
  2. Provide full-scale drawings of perforation patterns. Provide minimum 1"=1'-0" scale layout for each panel type showing perforation layout and orientation as indicated.
- E. Selection Samples: Manufacturer's color charts, indicating full range of colors, and patterns available.
- F. Samples for Verification: Full-size units (or as specified below) of each type of wall assembly indicated; in sets for each color, texture, and pattern specified, showing the full range of variations expected in these characteristics. Submit samples for each type specified.
  1. 12-inch square, (acoustical) metal pan units.
  2. 12-inch long samples of each exposed molding or trim.
  3. 12-inch long samples of each suspension component.
- G. Test Reports: Certified test data from an independent test agency verifying that panels meet specified requirements for acoustical and fire performance.
- H. Qualification Data: For firms and persons specified in "Quality Assurance" Provide documents to demonstrate their capabilities and experience. Include lists of at least 5 completed projects with project names and addresses, names and addresses of Architects and employers, and other information specified.
- I. Maintenance Materials: Furnish the following for Owner's use in maintenance of project.
  1. See Section 01 6000 - Product Requirements, for additional provisions.
  2. Extra Panels: Quantity equal to 5 percent of total installed, but not less than one of each type.

#### 1.05 QUALITY ASSURANCE

- A. Unless accepted otherwise by the Architect, use manufacturer and installers that employ a
  1. Quality Management System complying with the program described in ISO 9001-2000, or similar system.
- B. Installer
  1. To certify a minimum 5 years experience installing similar systems and scope to those specified.
    - a. Provide list of at least 5 successful installations with similar products and scope. Include names and contact numbers of Architect and employer for reference.
- C. Manufacturer
  1. To certify a minimum of 5 years experience manufacturing similar products to those specified.
    - a. Provide support documentation including name and date of project completion. Include names and contact numbers of Architect and employers for reference.
    - b. Manufacturer shall be single source and shall be the fabricator and supplier of appropriate major components.

**1.06 DELIVERY, STORAGE, AND HANDLING**

- A. Protect acoustical panels from moisture during shipment, storage, and handling. Deliver in factory-wrapped bundles; do not open bundles until panels are needed for installation.
- B. Store panels flat, in dry, well-ventilated space; do not stand panels on end.
- C. Protect panel edges from damage.

**1.07 MOCK-UP**

- A. See Section 01 4000 - Quality Requirements, for additional mock-up requirements.
- B. For approval of assembly, sequence of installation, coordination of trades involved, including ceiling panel types and shapes.
- C. Sized large enough to include a minimum of 2 adjacent panels demonstrating interface work of lighting, mechanical devices, electrical, railing, anchoring method and accessories.
- D. Construct mock-up of acoustical panels at location indicated by Architect.
  - 1. Minimum mock-up dimensions: 96 x 96 inches (2440 x 2440 mm). Provide wall and ceiling mock-ups in the same room.
  - 2. Approved mock-up may remain as part of the Work.
- E. Obtain Architect's approval of mock-ups before starting construction of acoustical metal pan walls. Submit detailed, ACAD shop drawing illustrating extent and scope of mock-ups. Do not proceed without approval of these drawings.
- F. Pre-installation Conference: Conduct conference at Project site as directed by the project Architect.

**1.08 DELIVERY, STORAGE, AND HANDLING**

- A. Deliver acoustical metal wall units and suspension system components in original, unopened packages clearly labeled with the following information: name of manufacturing source and location; product type, description and quantity; clients name and shipping address.
- B. Panel's protective layer to be removed only after installation is complete to help prevent panel surface damage.
- C. Store components in a fully enclosed space where they will be protected against physical damage from direct moisture, significant change in humidity, direct sunlight, significant change in temperature, surface contamination, and any other preventable cause.
- D. Exercise care in handling components to prevent damage to the surfaces and edges and prevent distortion or other physical damage. Comply with prescribed stacking instructions to prevent damage to thee components

**1.09 PROJECT CONDITIONS**

- A. Environmental Limitations
  - 1. Do not install acoustical metal pan walls until after spaces are enclosed and weather tight and after any wet work and work around walls is complete and accepted by project Architect.
  - 2. Maintain environmental conditions (temperature, humidity and ventilation) within limits recommended by manufacturer for optimum results. Do not install products under environmental conditions outside manufacturer's absolute limits. Allow materials to

reach ambient temperature and humidity for a minimum of 24 hours (48 hours recommended), prior to starting installation.

3. Coordinate with other work supported by, adjacent to or penetrating through the wall system.

#### **1.10 WARRANTY**

- A. Provide Manufacturers standard five year warranty against defects in materials or workmanship.

### **PART 2 PRODUCTS**

#### **2.01 PERFORMANCE REQUIREMENTS**

- A. VOC Limits for adhesives, sealants, fillers, primers and coatings . Comply with limits specified in related section.
- B. Fire-Test-Response Characteristics: Provide acoustical metal pan walls that comply with one of the following requirements:
  1. Fire-response tests performed by UL, ITS/Warnock Hersey, or another independent testing and inspecting agency that is acceptable to authorities having jurisdiction and that performs testing and follow-up services.
  2. Surface-burning characteristics of acoustical metal pans comply with ASTM E 1264 for Class A materials as determined by testing identical products per ASTM E 84.
- C. Composite Wood products must meet current CARB Airborne Toxic Control Measure (ATCM) for Composite Wood Formaldehyde Limits by Mandatory Compliance Dates as specified in Section 01 6116.

#### **2.02 MANUFACTURERS**

- A. Basis of design: "WallForms" by Ceilings Plus - 6711 E. Washington Blvd., Los Angeles, CA 90040, (800) 822-3411 - www.ceilingplus.com. Contact: CADE Architectural Resources, E. Earl Carter, ecarter@caderesources.com, (415) 805-8584.
- B. Substitutions: See Section 01 6000 - Product Requirements.
- C. Provide all products by one manufacturer.

#### **2.03 METAL ACOUSTICAL PANELS**

- A. Panel Type MAP-1 - Ceilings Plus "WallForms™" - Perforated - finish to match Architect's sample; or approved equal.
  1. Panels are to be manufactured from single sheets of aluminum selected for surface flatness, smoothness and freedom from surface blemishes where exposed to view in a finished unit. Do not use material where the exposed surface exhibit pitting, seam marks, roller marks, stains, discolorations, or variations in flatness exceeding those permitted by referenced standards for stretcher-leveled aluminum alloy sheets.
  2. Panels are to be die-formed with a minimum 1 1/2" integral return edge on each of the four panel sides. Hooks to engage the panels into a factory engineered hat channel, shall be an integral part of the panel flange. No fasteners of any kind shall be visible on exposed face surfaces of ceiling panels or support tees. Wall penetrations shall be factory precision cut whenever viable.
  3. Panel material shall be primed aluminum sheet type 3105 (painted) / 5005 (anodized) series alloy that has a minimum 70% (50% @ 5005) recycled content. It shall be machine stretcher-leveled and a minimum of .032" thickness, or greater if required, so that the panel deflection does not exceed L/360.
  4. Panel Finish: One or more of the following as indicated on the Drawings;

09 8448 - METAL-FACED ACOUSTICAL PANELS

- a. "Sarante" PVC free, faux wood veneer that is permanently bonded to the aluminum sheet with formaldehyde free, water based adhesive of minimum bond strength of 8 psi @ 25 degrees C.
  - b. "Arboreal" real wood veneer that is permanently bonded to the aluminum sheet with formaldehyde free, water based adhesive of minimum bond strength of 8 psi @ 25 degrees C.
  - c. Polyester "Painted" finish - 3105 alloy
  - d. Flouropolymer "Painted" finish - 3105 alloy
  - e. "Anodized" finish - 5005 alloy
5. Panel sizes as per drawings. Field-cut panels at non-modular perimeter conditions, at column interfaces or as detailed or specified.
  6. Edge Profile: Panel joints are butt condition (concealed suspension) both directions (or as per drawings) unless specified otherwise.
  7. Perforation shall be as selected by the Architect from Ceilings Plus' standard patterns. Panels to have solid non-perforated borders along each of the four sides.
  8. Sound-Absorptive Fabric Layer: Provide manufacturer's acoustic pads sized to fit concealed surface of panel. Material shall be both non-flammable and sound-absorptive.
    - a. Fire Class shall be Class A, with surface-burning characteristics for flame-spread rating of 25 or less and smoke developed rating of 50 or less. Provide independent accredited lab test results showing compliance with Class-A rating as per ASTM E 84.
    - b. Achieve absorption value of not less than 0.70 NRC. Provide independent accredited laboratory test results illustrating compliance with acoustical requirements as per ASTM C 423.
    - c. Acoustical metal panel wall to provide recycled cotton, "Ultrasorb" in sufficient thickness to achieve NRC rating specified.
    - d. Install acoustical pads to the backside of the perforated panels, unless otherwise directed by the Architect.
  9. The plenum shall be 100% accessible. Every panel must be removable. Progressive panel access is not acceptable.
  10. Fire Tests: Complete system test including suspension, primed aluminum and finish shall meet ASTM E 84 Class A.
  11. Provide and install matching finish trim on each side of each area (or as specified).

#### **2.04 METAL SUSPENSION SYSTEMS. GENERAL**

- A. Metal Suspension Standard: Provide panel manufacturer's metal suspension systems of materials and finishes indicated.
  1. Hat channels to made of minimum 22-gauge steel.
  2. Backer plates to made of minimum 18-gauge steel.
  3. Face of hat channels and backer plates to be factory-finished matte black unless known otherwise.
  4. Face of hat channels to be factory slotted to receive panel hooks
  5. Provide suspension system made from steel sheet with an average recycled content such that post consumer recycled content plus one half or pre-consumer content is not less than 25 percent.
- B. Suspension Systems: Provide complete suspensions systems with vertical hat channels, backer plates, trim molding and other suspension components required to support wall and other wall supported construction (some of these parts may be supplied by the installer).
- C. Attachment Devices: Size for five times design load, unless otherwise indicated (supplied by installer)



1. Provide anchor, for use in the particular application, as approved by the "Structural Engineer of record".
2. Structural substrate, as indicated to support attachment device, also to be approved by the "Structural Engineer of record".
3. Anchors specified must provide corrosion resistance as per metal type and application.

## **2.05 FABRICATION**

- A. General: Fabricate panels to sizes and configurations indicated, with panel facing installed without defects, blisters, or visible seams.
  1. All edges and faces fully formed and finished, no cut edges or exposed panel filler.
- B. Tolerances: Fabricate to finished tolerance of plus or minus 1/16 inch (1.6 mm) for thickness, overall length and width, and squareness from corner to corner.

## **2.06 ACCESSORIES**

- A. Spline-Mounting Accessories: Manufacturer's standard concealed connecting splines of extruded aluminum designed for screw attachment to walls, with coordinating moldings and trim for interior and exterior corners and miscellaneous conditions.
  1. Color of Exposed Trim: As selected from manufacturer's standards.
- B. Trim Moldings: Manufacturer's standard metal trim moldings for concealing panel joints; color as selected from manufacturer's standards.

## **PART 3 EXECUTION**

### **3.01 EXAMINATION**

- A. Examine substrates and structural framing to which acoustical metal panels attach or abut, with Installer present, for compliance with requirements specified in this and other Sections that affect installation and anchorage, and other conditions affecting performance of metal panel walls.
- B. Proceed with installation only after unsatisfactory conditions have been corrected.

### **3.02 PREPARATION**

- A. Coordination: Furnish layouts for cast-in-place anchors, clips, and other anchors whose installation is specified in other Sections.
- B. Measure each wall area and establish layout of acoustical metal pan units to balance border widths at opposite edges of each wall. Avoid using less-than-half-width units at borders, and comply with layout shown on elevation plan layouts.
- C. Survey substrate for wall attachment to assure squareness and proper elevation for wall panel installation.

### **3.03 INSTALLATION**

- A. General: Install acoustical metal pan walls, per manufacturers shop drawings provided, per manufacturer's written instructions.
- B. Suspend hat channels and backer plates from building's approved structural substrates and as follows:
  1. Install hat channels and backer plates plumb and free from contact with insulation or other objects within wall system that are not structural support members
  2. Space hangers not more than 48 inches on center, along each member supported directly from hangers, unless otherwise indicated; and provide hangers not more than 8 inches

- from ends of each member. Supply supporting calculations from licensed Structural Engineer verifying mount spacing meets all requirements, when spacings exceed those recommended.
3. Fine level suspension to 1/8 inch in 10 feet from specified elevation(s), square and true.
  4. Adjust suspension system runners so they are square (within .5 degree from 90 degrees) and securely interlocked with one another. Remove and replace dented, bent, or kinked members.
- C. Install edge moldings and trim of type indicated at perimeter of acoustical wall areas and where necessary to conceal edges of acoustical metal pan. Method of edge trim attachment and design of edge trims to be approved by Architect.
1. Screw attach moldings to substrate at intervals not more than 18" O.C. and not more than 6" from ends, leveling with wall suspension system to a tolerance of 1/8" in 10'. Miter corners accurately and connect securely.
  2. Do not use exposed fasteners, including pop rivets, on moldings and trim without prior written approval. Or unless detailed otherwise.
- D. Scribe and cut acoustical metal panel units for accurate fit at penetrations by, other work through walls. Stiffen edges of cut units as required to eliminate evidence of buckling or variations in flatness exceeding referenced standards for stretcher-leveled metal sheet.
- E. Install acoustical metal panel units in coordination with suspension system.
1. Align joints in adjacent courses to form uniform, straight joints parallel to room axis in both directions, unless otherwise indicated. Install directionally patterned or textured panels in directions indicated on approved shop drawings. Panel-joints shall flow smoothly and in a straight line within 1/8" in 10'. Intersections shall be continuous.
  2. Fit adjoining units to form flush, tight joints. Scribe and cut units for accurate fit at borders and around construction penetrating wall.
  3. Remove protective film from panels only when space is completely clean and free of airborne particles. Use white cotton gloves for final installation of panels into grid system.
- F. Install panels to construction tolerances of plus or minus 1/16 inch (1.6 mm) for the following:
1. Plumb and level.
  2. Flatness.
  3. Width of joints.

### **3.04 ADJUSTING AND CLEANING**

- A. Adjust wall components to provide a consistent finish and appearance in conformity with established tolerances and requirements.
- B. Clean exposed surfaces of acoustical metal panel walls. Comply with manufacturer's written instructions for cleaning and touchup of minor finish damage.
- C. Remove and replace work that cannot be successfully cleaned and repaired to permanently eliminate evidence of damage, including dented and bent units.

### **3.05 PROTECTION**

- A. Provide protection of installed acoustical panels until completion of the work.

**END OF SECTION**

**SECTION 09 8448**  
**METAL-FACED ACOUSTICAL PANELS**

**PART 1 GENERAL**

**1.01 SECTION INCLUDES**

- A. Perforated and un-perforated metal wall panels
- B. Acoustical backing.
- C. Suspension assemblies
- D. Accessories; provide other necessary items including devices for attachment overhead construction, secondary members, splines, splices, connecting clips, wall connectors, trims, and other devices required for a complete installation.
- E. Supplemental support framing: Provide fully engineered secondary framing as required to meet code, conforming to layout shown in drawings, to support metal wall suspension system.
- F. Reinforced corner wall trim: Provide fully engineered, reinforced corner wall trim in 1/16" thickness and custom profile; finished to match adjacent wall panels. Or as otherwise noted in the drawings.
- G. Coordinate layout and installation of items penetrating or being installed into wall systems with responsible trades.

**1.02 RELATED REQUIREMENTS**

- A. Section 01 6116 - Volatile Organic Compound (VOC) Content Restrictions.
- B. Section 01 8113 - Sustainable Design Requirements.
- C. Section 06 2000 - Finish Carpentry.
- D. Pertinent sections specifying work penetrating metal-faced panel assemblies.

**1.03 REFERENCE STANDARDS**

- A. ASTM C423 - Standard Test Method for Sound Absorption and Sound Absorption Coefficients by the Reverberation Room Method; 2009a.
- B. ASTM E84 - Standard Test Method for Surface Burning Characteristics of Building Materials; 2015a.
- C. California Code of Regulations, Title 24, Part 2, California Building Code (CBC), International Building Code.
- D. California Code of Regulations, Title 24, Part 11 California Green Building Standards Code, "CAL-Green".

**1.04 SUBMITTALS**

- A. See Section 01 3300 - Submittals, for submittal procedures.
- B. Product Data: Manufacturer's printed data sheets for products specified.
- C. CAL-GREEN Submittals:
  - 1. Product Data - VOC Limits: For adhesives, sealants, fillers, primers and coatings, documentation including printed statement of VOC contents, comply with limits specified in related section.

2. Composite Wood Formaldehyde Limits: Provide certification that all products meet current CARB Airborne Toxic Control Measure (ATCM) for Composite Wood Formaldehyde Limits by Mandatory Compliance Dates as specified in related section.
- D. Shop Drawings: Fabrication and installation details, panel layout on wall elevations, panel pattern and type.
  1. Include location of wall-mounted items and work penetrating panels, such as lighting, fire alarm and similar items.
  2. Provide full-scale drawings of perforation patterns. Provide minimum 1"=1'-0" scale layout for each panel type showing perforation layout and orientation as indicated.
- E. Selection Samples: Manufacturer's color charts, indicating full range of colors, and patterns available.
- F. Samples for Verification: Full-size units (or as specified below) of each type of wall assembly indicated; in sets for each color, texture, and pattern specified, showing the full range of variations expected in these characteristics. Submit samples for each type specified.
  1. 12-inch square, (acoustical) metal pan units.
  2. 12-inch long samples of each exposed molding or trim.
  3. 12-inch long samples of each suspension component.
- G. Test Reports: Certified test data from an independent test agency verifying that panels meet specified requirements for acoustical and fire performance.
- H. Qualification Data: For firms and persons specified in "Quality Assurance" Provide documents to demonstrate their capabilities and experience. Include lists of at least 5 completed projects with project names and addresses, names and addresses of Architects and employers, and other information specified.
- I. Maintenance Materials: Furnish the following for Owner's use in maintenance of project.
  1. See Section 01 6000 - Product Requirements, for additional provisions.
  2. Extra Panels: Quantity equal to 5 percent of total installed, but not less than one of each type.

#### **1.05 QUALITY ASSURANCE**

- A. Unless accepted otherwise by the Architect, use manufacturer and installers that employ a
  1. Quality Management System complying with the program described in ISO 9001-2000, or similar system.
- B. Installer
  1. To certify a minimum 5 years experience installing similar systems and scope to those specified.
    - a. Provide list of at least 5 successful installations with similar products and scope. Include names and contact numbers of Architect and employer for reference.
- C. Manufacturer
  1. To certify a minimum of 5 years experience manufacturing similar products to those specified.
    - a. Provide support documentation including name and date of project completion. Include names and contact numbers of Architect and employers for reference.
    - b. Manufacturer shall be single source and shall be the fabricator and supplier of appropriate major components.

#### **1.06 DELIVERY, STORAGE, AND HANDLING**

- A. Protect acoustical panels from moisture during shipment, storage, and handling. Deliver in factory-wrapped bundles; do not open bundles until panels are needed for installation.

- B. Store panels flat, in dry, well-ventilated space; do not stand panels on end.
- C. Protect panel edges from damage.

#### **1.07 MOCK-UP**

- A. See Section 01 4000 - Quality Requirements, for additional mock-up requirements.
- B. For approval of assembly, sequence of installation, coordination of trades involved, including ceiling panel types and shapes.
- C. Sized large enough to include a minimum of 2 adjacent panels demonstrating interface work of lighting, mechanical devices, electrical, railing, anchoring method and accessories.
- D. Construct mock-up of acoustical panels at location indicated by Architect.
  - 1. Minimum mock-up dimensions: 96 x 96 inches (2440 x 2440 mm). Provide wall and ceiling mock-ups in the same room.
  - 2. Approved mock-up may remain as part of the Work.
- E. Obtain Architect's approval of mock-ups before starting construction of acoustical metal pan walls. Submit detailed, ACAD shop drawing illustrating extent and scope of mock-ups. Do not proceed without approval of these drawings.
- F. Pre-installation Conference: Conduct conference at Project site as directed by the project Architect.

#### **1.08 DELIVERY, STORAGE, AND HANDLING**

- A. Deliver acoustical metal wall units and suspension system components in original, unopened packages clearly labeled with the following information: name of manufacturing source and location; product type, description and quantity; clients name and shipping address.
- B. Panel's protective layer to be removed only after installation is complete to help prevent panel surface damage.
- C. Store components in a fully enclosed space where they will be protected against physical damage from direct moisture, significant change in humidity, direct sunlight, significant change in temperature, surface contamination, and any other preventable cause.
- D. Exercise care in handling components to prevent damage to the surfaces and edges and prevent distortion or other physical damage. Comply with prescribed stacking instructions to prevent damage to thee components

#### **1.09 PROJECT CONDITIONS**

- A. Environmental Limitations
  - 1. Do not install acoustical metal pan walls until after spaces are enclosed and weather tight and after any wet work and work around walls is complete and accepted by project Architect.
  - 2. Maintain environmental conditions (temperature, humidity and ventilation) within limits recommended by manufacturer for optimum results. Do not install products under environmental conditions outside manufacturer's absolute limits. Allow materials to reach ambient temperature and humidity for a minimum of 24 hours (48 hours recommended), prior to starting installation.
  - 3. Coordinate with other work supported by, adjacent to or penetrating through the wall system.

### 1.10 WARRANTY

- A. Provide Manufacturers standard five year warranty against defects in materials or workmanship.

## PART 2 PRODUCTS

### 2.01 PERFORMANCE REQUIREMENTS

- A. VOC Limits for adhesives, sealants, fillers, primers and coatings . Comply with limits specified in related section.
- B. Fire-Test-Response Characteristics: Provide acoustical metal pan walls that comply with one of the following requirements:
  - 1. Fire-response tests performed by UL, ITS/Warnock Hersey, or another independent testing and inspecting agency that is acceptable to authorities having jurisdiction and that performs testing and follow-up services.
  - 2. Surface-burning characteristics of acoustical metal pans comply with ASTM E 1264 for Class A materials as determined by testing identical products per ASTM E 84.
- C. Composite Wood products must meet current CARB Airborne Toxic Control Measure (ATCM) for Composite Wood Formaldehyde Limits by Mandatory Compliance Dates as specified in Section 01 6116.

### 2.02 MANUFACTURERS

- A. Basis of design: "WallForms" by Ceilings Plus - 6711 E. Washington Blvd., Los Angeles, CA 90040, (800) 822-3411 - www.ceilingplus.com. Contact: CADE Architectural Resources, E. Earl Carter, ecarter@caderesources.com, (415) 805-8584.
- B. Substitutions: See Section 01 6000 - Product Requirements.
- C. Provide all products by one manufacturer.

### 2.03 METAL ACOUSTICAL PANELS

- A. Panel Type MAP-1 - Ceilings Plus "WallForms™" - Perforated - finish to match Architect's sample; or approved equal.
  - 1. Panels are to be manufactured from single sheets of aluminum selected for surface flatness, smoothness and freedom from surface blemishes where exposed to view in a finished unit. Do not use material where the exposed surface exhibit pitting, seam marks, roller marks, stains, discolorations, or variations in flatness exceeding those permitted by referenced standards for stretcher-leveled aluminum alloy sheets.
  - 2. Panels are to be die-formed with a minimum 1 1/2" integral return edge on each of the four panel sides. Hooks to engage the panels into a factory engineered hat channel, shall be an integral part of the panel flange. No fasteners of any kind shall be visible on exposed face surfaces of ceiling panels or support tees. Wall penetrations shall be factory precision cut whenever viable.
  - 3. Panel material shall be primed aluminum sheet type 3105 (painted) / 5005 (anodized) series alloy that has a minimum 70% (50% @ 5005) recycled content. It shall be machine stretcher-leveled and a minimum of .032" thickness, or greater if required, so that the panel deflection does not exceed L/360.
  - 4. Panel Finish: One or more of the following as indicated on the Drawings;
    - a. "Sarante" PVC free, faux wood veneer that is permanently bonded to the aluminum sheet with formaldehyde free, water based adhesive of minimum bond strength of 8 psi @ 25 degrees C.
    - b. "Arboreal" real wood veneer that is permanently bonded to the aluminum sheet with formaldehyde free, water based adhesive of minimum bond strength of 8 psi @ 25 degrees C.

- c. Polyester "Painted" finish - 3105 alloy
- d. Fluoropolymer "Painted" finish - 3105 alloy
- e. "Anodized" finish - 5005 alloy
5. Panel sizes as per drawings. Field-cut panels at non-modular perimeter conditions, at column interfaces or as detailed or specified.
6. Edge Profile: Panel joints are butt condition (concealed suspension) both directions (or as per drawings) unless specified otherwise.
7. Perforation shall be as selected by the Architect from Ceilings Plus' standard patterns. Panels to have solid non-perforated borders along each of the four sides.
8. Sound-Absorptive Fabric Layer: Provide manufacturer's acoustic pads sized to fit concealed surface of panel. Material shall be both non-flammable and sound-absorptive.
  - a. Fire Class shall be Class A, with surface-burning characteristics for flame-spread rating of 25 or less and smoke developed rating of 50 or less. Provide independent accredited lab test results showing compliance with Class-A rating as per ASTM E 84.
  - b. Achieve absorption value of not less than 0.70 NRC. Provide independent accredited laboratory test results illustrating compliance with acoustical requirements as per ASTM C 423.
  - c. Acoustical metal panel wall to provide recycled cotton, "Ultrasorb" in sufficient thickness to achieve NRC rating specified.
  - d. Install acoustical pads to the backside of the perforated panels, unless otherwise directed by the Architect.
9. The plenum shall be 100% accessible. Every panel must be removable. Progressive panel access is not acceptable.
10. Fire Tests: Complete system test including suspension, primed aluminum and finish shall meet ASTM E 84 Class A.
11. Provide and install matching finish trim on each side of each area (or as specified).

#### **2.04 METAL SUSPENSION SYSTEMS. GENERAL**

- A. Metal Suspension Standard: Provide panel manufacturer's metal suspension systems of materials and finishes indicated.
  1. Hat channels to made of minimum 22-gauge steel.
  2. Backer plates to made of minimum 18-gauge steel.
  3. Face of hat channels and backer plates to be factory-finished matte black unless known otherwise.
  4. Face of hat channels to be factory slotted to receive panel hooks
  5. Provide suspension system made from steel sheet with an average recycled content such that post consumer recycled content plus one half or pre-consumer content is not less than 25 percent.
- B. Suspension Systems: Provide complete suspensions systems with vertical hat channels, backer plates, trim molding and other suspension components required to support wall and other wall supported construction (some of these parts may be supplied by the installer).
- C. Attachment Devices: Size for five times design load, unless otherwise indicated (supplied by installer)
  1. Provide anchor, for use in the particular application, as approved by the "Structural Engineer of record".
  2. Structural substrate, as indicated to support attachment device, also to be approved by the "Structural Engineer of record".
  3. Anchors specified must provide corrosion resistance as per metal type and application.

## **2.05 FABRICATION**

- A. General: Fabricate panels to sizes and configurations indicated, with panel facing installed without defects, blisters, or visible seams.
  - 1. All edges and faces fully formed and finished, no cut edges or exposed panel filler.
- B. Tolerances: Fabricate to finished tolerance of plus or minus 1/16 inch (1.6 mm) for thickness, overall length and width, and squareness from corner to corner.

## **2.06 ACCESSORIES**

- A. Spline-Mounting Accessories: Manufacturer's standard concealed connecting splines of extruded aluminum designed for screw attachment to walls, with coordinating moldings and trim for interior and exterior corners and miscellaneous conditions.
  - 1. Color of Exposed Trim: As selected from manufacturer's standards.
- B. Trim Moldings: Manufacturer's standard metal trim moldings for concealing panel joints; color as selected from manufacturer's standards.

## **PART 3 EXECUTION**

### **3.01 EXAMINATION**

- A. Examine substrates and structural framing to which acoustical metal panels attach or abut, with Installer present, for compliance with requirements specified in this and other Sections that affect installation and anchorage, and other conditions affecting performance of metal panel walls.
- B. Proceed with installation only after unsatisfactory conditions have been corrected.

### **3.02 PREPARATION**

- A. Coordination: Furnish layouts for cast-in-place anchors, clips, and other anchors whose installation is specified in other Sections.
- B. Measure each wall area and establish layout of acoustical metal pan units to balance border widths at opposite edges of each wall. Avoid using less-than-half-width units at borders, and comply with layout shown on elevation plan layouts.
- C. Survey substrate for wall attachment to assure squareness and proper elevation for wall panel installation.

### **3.03 INSTALLATION**

- A. General: Install acoustical metal pan walls, per manufacturers shop drawings provided, per manufacturer's written instructions.
- B. Suspend hat channels and backer plates from building's approved structural substrates and as follows:
  - 1. Install hat channels and backer plates plumb and free from contact with insulation or other objects within wall system that are not structural support members
  - 2. Space hangers not more than 48 inches on center, along each member supported directly from hangers, unless otherwise indicated; and provide hangers not more than 8 inches from ends of each member. Supply supporting calculations from licensed Structural Engineer verifying mount spacing meets all requirements, when spacings exceed those recommended.
  - 3. Fine level suspension to 1/8 inch in 10 feet from specified elevation(s), square and true.
  - 4. Adjust suspension system runners so they are square (within .5 degree from 90 degrees) and securely interlocked with one another. Remove and replace dented, bent, or kinked members.



- C. Install edge moldings and trim of type indicated at perimeter of acoustical wall areas and where necessary to conceal edges of acoustical metal pan. Method of edge trim attachment and design of edge trims to be approved by Architect.
  - 1. Screw attach moldings to substrate at intervals not more than 18" O.C. and not more than 6" from ends, leveling with wall suspension system to a tolerance of 1/8" in 10'. Miter corners accurately and connect securely.
  - 2. Do not use exposed fasteners, including pop rivets, on moldings and trim without prior written approval. Or unless detailed otherwise.
- D. Scribe and cut acoustical metal panel units for accurate fit at penetrations by, other work through walls. Stiffen edges of cut units as required to eliminate evidence of buckling or variations in flatness exceeding referenced standards for stretcher-leveled metal sheet.
- E. Install acoustical metal panel units in coordination with suspension system.
  - 1. Align joints in adjacent courses to form uniform, straight joints parallel to room axis in both directions, unless otherwise indicated. Install directionally patterned or textured panels in directions indicated on approved shop drawings. Panel-joints shall flow smoothly and in a straight line within 1/8" in 10'. Intersections shall be continuous.
  - 2. Fit adjoining units to form flush, tight joints. Scribe and cut units for accurate fit at borders and around construction penetrating wall.
  - 3. Remove protective film from panels only when space is completely clean and free of airborne particles. Use white cotton gloves for final installation of panels into grid system.
- F. Install panels to construction tolerances of plus or minus 1/16 inch (1.6 mm) for the following:
  - 1. Plumb and level.
  - 2. Flatness.
  - 3. Width of joints.

### **3.04 ADJUSTING AND CLEANING**

- A. Adjust wall components to provide a consistent finish and appearance in conformity with established tolerances and requirements.
- B. Clean exposed surfaces of acoustical metal panel walls. Comply with manufacturer's written instructions for cleaning and touchup of minor finish damage.
- C. Remove and replace work that cannot be successfully cleaned and repaired to permanently eliminate evidence of damage, including dented and bent units.

### **3.05 PROTECTION**

- A. Provide protection of installed acoustical panels until completion of the work.

**END OF SECTION**

**SECTION 09 9113**  
**EXTERIOR PAINTING**

**PART 1 GENERAL**

**1.01 SECTION INCLUDES**

- A. Surface preparation.
- B. Field application of paints.
- C. Materials for backpriming woodwork.
- D. Scope: Finish exterior surfaces exposed to view, unless fully factory-finished and unless otherwise indicated, including the following:
  - 1. Exposed surfaces of steel lintels and ledge angles.
  - 2. Mechanical and Electrical:
    - a. On the roof and outdoors, paint equipment that is exposed to weather or to view, including factory-finished materials.

**1.02 RELATED REQUIREMENTS**

- A. Section 01 6116 - Volatile Organic Compound (VOC) Content Restrictions.
- B. Pertinent sections of Division 05 specifying shop-primed and galvanized metal items.
- C. Section 09 9123 - Interior Painting.
- D. Pertinent sections specifying civil, mechanical and electrical work requiring painting.
- E. Pertinent Division 32 Section specifying Painted Pavement Markings.

**1.03 DEFINITIONS**

- A. Comply with ASTM D16 for interpretation of terms used in this section.

**1.04 REFERENCE STANDARDS**

- A. ASTM D16 - Standard Terminology for Paint, Related Coatings, Materials, and Applications; 2014.
- B. Manufacturer's recommendations and specifications, including installation instructions.
- C. MPI (APSM) - Master Painters Institute Architectural Painting Specification Manual; Current Edition, [www.paintinfo.com](http://www.paintinfo.com).
- D. SSPC-SP 1 - Solvent Cleaning; 2015.
- E. SSPC-SP 2 - Hand Tool Cleaning; 1982 (Ed. 2004).
- F. SSPC-SP 6 - Commercial Blast Cleaning; 2007.
- G. SSPC-SP 13 - Surface Preparation of Concrete; (Reaffirmed 2015); 2003.

**1.05 SUBMITTALS**

- A. See Section 01 3300 - Submittals, for submittal procedures.
- B. Product Data: Provide complete list of products to be used, with the following information for each:
  - 1. Manufacturer's name, product name and/or catalog number, and general product category (e.g. "alkyd enamel").
  - 2. MPI product number (e.g. MPI #47).

3. Cross-reference to specified paint system(s) product is to be used in; include description of each system.
  4. Manufacturer's installation instructions.
  5. If proposal of substitutions is allowed under submittal procedures, explanation of substitutions proposed.
  6. Resin Type.
  7. Total VOC Content in grams per liter.
  8. Solids Content By Volume SCBV (not solids by weight). All products shall be minimum 35% SCBV.
  9. Composition-By-Weight. Demonstrate composition by percentage related to total weight of all components.
  10. Film Thickness Per Coat, Wet and Dry.
  11. Prime Pigment: Demonstrate prime pigment by percentage related to total volume of all components.
- C. Samples: Submit three paper "draw down" samples, 8-1/2 by 11 inches (216 by 279 mm) in size, illustrating range of colors available for each finishing product specified.
1. Where sheen is specified, submit samples in only that sheen.
  2. Where sheen is not specified, discuss sheen options with Architect before preparing samples, to eliminate sheens definitely not required.
  3. Allow 30 days for approval process, after receipt of complete samples by Architect.
  4. Paint color submittals will not be considered until color submittals for major materials not to be painted, such as masonry, have been approved.
- D. Certification: By manufacturer that paints and finishes comply with VOC limits specified.
- E. Manufacturer's Instructions: Indicate special surface preparation procedures.
- F. Maintenance Data: Submit data including finish schedule showing where each product/color/finish was used, product technical data sheets, material safety data sheets (MSDS), care and cleaning instructions, touch-up procedures, repair of painted and finished surfaces, and color samples of each color and finish used.
- G. Maintenance Materials: Furnish the following for Owner's use in maintenance of project.
1. See Section 01 6000 - Product Requirements, for additional provisions.
  2. Extra Paint and Finish Materials: 1 gallon (4 L) of each color; from the same product run, store where directed.
  3. Label each container with color in addition to the manufacturer's label.

#### **1.06 QUALITY ASSURANCE**

- A. Manufacturer Qualifications: Company specializing in manufacturing the products specified, with minimum ten (10) years documented experience.
- B. Applicator Qualifications: Company specializing in performing the type of work specified with minimum five (5) years experience and approved by manufacturer.

#### **1.07 MOCK-UP**

- A. See Section 01 4000 - Quality Requirements, for general requirements for mock-up.
- B. Provide panel, 8 feet (\_\_\_ m) long by 10 feet (\_\_\_ m) wide, illustrating paint color, texture, and finish.
- C. Provide door and frame assembly illustrating paint color, texture, and finish.
- D. Locate where directed by Architect.
- E. Final color selections and acceptance will be made only after review of mock-ups under lighting conditions approximating finish conditions.

- F. Mock-up may remain as part of the work.

#### **1.08 DELIVERY, STORAGE, AND HANDLING**

- A. Deliver products to site in sealed and labeled containers; inspect to verify acceptability.
- B. Container Label: Include manufacturer's name, type of paint, brand name, lot number, brand code, coverage, surface preparation, drying time, cleanup requirements, color designation, and instructions for mixing and reducing.
- C. Paint Materials: Store at minimum ambient temperature of 45 degrees F (7 degrees C) and a maximum of 90 degrees F (32 degrees C), in ventilated area, and as required by manufacturer's instructions.

#### **1.09 FIELD CONDITIONS**

- A. Do not apply materials when surface and ambient temperatures are outside the temperature ranges required by the paint product manufacturer.
- B. Follow manufacturer's recommended procedures for producing best results, including testing of substrates, moisture in substrates, and humidity and temperature limitations.
- C. Do not apply exterior paint and finishes during rain, high wind or snow, or when relative humidity is outside the humidity ranges required by the paint product manufacturer.
  - 1. Do not paint exterior materials when inclement weather is expected within the full drying time specified by the manufacturer.
  - 2. Painting may be continued during inclement weather if areas and surfaces to be painted are enclosed and heated and dry within temperature and humidity limits specified by paint manufacturer during application and drying periods.
- D. Schedule work to avoid painting surfaces, when surfaces are exposed to direct sunlight.
- E. Provide lighting level of 80 ft candles (860 lx) measured mid-height at substrate surface.

### **PART 2 PRODUCTS**

#### **2.01 DESIGN REQUIREMENTS**

- A. Design Intent: Paint all Work which is normally painted in a building of this type and quality, whether or not the item or surface is specifically identified within the Contract Documents.
  - 1. The number of coats specified is the minimum to be applied. Provide paint finishes of even, uniform color, free from cloudy or mottled surfaces. Provide one additional coat if necessary where "deep colors" are selected.
  - 2. Non-scheduled items: Provide manufacturer's approved and recommended system as set forth in Manufacturer's "Specifications Architectural Finishes".

#### **2.02 MANUFACTURERS**

- A. Manufacturer's proprietary names or catalog numbers are indicated for convenience in identifying products. Manufacturer's complete product catalog description and composition for indicated product names or numbers shall constitute requirements for each product specified. Products shall incorporate all attributes set forth in the manufacturer's catalog description for the specified item, except for such modifications thereto as may be indicated in the Contract Documents.
- B. Provide paints and finishes from the same manufacturer to the greatest extent possible, unless noted otherwise on the drawings..

1. In the event that a single manufacturer cannot provide specified products, minor exceptions will be permitted provided approval by Architect is obtained using the specified procedures for substitutions.
  2. Substitution of other products by the same manufacturer is preferred over substitution of products by a different manufacturer.
  3. Substitution of a different paint system using MPI-approved products by the same manufacturer will be considered.
- C. Substitutions: See Section 01 6000 - Product Requirements.
1. Provide product data documenting conformance to specified requirements and provide all specified information as listed above in SUBMITTALS article. Failure to include all information specified is grounds for rejection of substitution.
- D. Paints:
1. Base Manufacturer: Sherwin-Williams Company.
  2. Kelly-Moore; www.kellymoore.com.

### 2.03 PAINTS AND FINISHES - GENERAL

- A. Paints and Finishes: Ready mixed, unless required to be a field-catalyzed paint.
1. Provide paints and finishes of a soft paste consistency, capable of being readily and uniformly dispersed to a homogeneous coating, with good flow and brushing properties, and capable of drying or curing free of streaks or sags.
  2. Provide materials that are compatible with one another and the substrates indicated under conditions of service and application, as demonstrated by manufacturer based on testing and field experience.
  3. For opaque finishes, tint each coat including primer coat and intermediate coats, one-half shade lighter than succeeding coat, with final finish coat as base color.
  4. Supply each paint material in quantity required to complete entire project's work from a single production run.
  5. Do not reduce, thin, or dilute paint or finishes or add materials unless such procedure is specifically described in manufacturer's product instructions.
- B. Volatile Organic Compound (VOC) Content: Comply with Section 01 6116.
1. Provide products conforming with local, State and Federal government requirements limiting the amount of volatile organic compounds contained in the product, for its intended application. If specified product does not comply with current requirement, provide conforming product at no additional cost.
- C. Chemical Content: The following compounds are prohibited:
1. Intentionally added methylene chloride or perchloroethylene.
  2. Aromatic Compounds: In excess of 1.0 percent by weight of total aromatic compounds (hydrocarbon compounds containing one or more benzene rings).
  3. Acrolein, acrylonitrile, antimony, benzene, butyl benzyl phthalate, cadmium, di (2-ethylhexyl) phthalate, di-n-butyl phthalate, di-n-octyl phthalate, 1,2-dichlorobenzene, diethyl phthalate, dimethyl phthalate, ethylbenzene, ethylene glycol, formaldehyde, hexavalent chromium, isophorone, lead, mercury, methyl ethyl ketone, methyl isobutyl ketone, methylene chloride, naphthalene, toluene (methylbenzene), 1,1,1-trichloroethane, vinyl chloride.
- D. Flammability: Comply with applicable code for surface burning characteristics.
- E. Sheens: Provide the sheens specified; where sheen is not specified, sheen will be selected later by Architect from the manufacturer's full line.
1. Finish Sheen: The following designations are measured in percentage of reflectance when viewed at a 60 degree angle. Provide manufacturer's standard sheen most closely matching the characteristic of specified sheen.
    - a. Flat: 0-5%.

- b. Velvet: 5-9%.
  - c. Eggshell: 10-15%.
  - d. Low Sheen: 20-25%.
  - e. Semi-Gloss: 40-50%
  - f. Gloss: 70-80%
  - g. High Gloss: >85%
- F. Colors: As indicated on drawings.
- 1. Allow for minimum of three colors for each system, unless otherwise indicated, without additional cost to Owner.
  - 2. Extend colors to surface edges; colors may change at any edge as directed by Architect.
  - 3. In finished areas, finish pipes, ducts, conduit, and equipment the same color as the wall/ceiling they are mounted on/under unless accent colors are denoted.
- G. Fabricate paints and stains in accordance with the Color Schedule which will include both standard colors and special, non-standard colors.
- 1. If deep colors are not available in a specified product, propose substitute formula for approval
  - 2. Tint undercoats slightly to approximate finish coat color

## 2.04 PAINT SYSTEMS - EXTERIOR

- A. New Exterior Plaster: Acrylic finish per Section 09 2513 - Acrylic Modified Portland Cement Plastering.
- B. Paint WE-OP-3L - Wood, Opaque, Latex, 3 Coat:
- 1. Satin Acrylic: Two finish coats over a primer.
    - a. Primer Coat (4.0 mils):
    - b. Intermediate (1.5 mils):
    - c. Final Coats (1.5 mils):
  - 2. Sherwin Williams Products: If any of the products below are discontinued, submit alternate products approved by the Manufacturer in writing.
    - a. SW Durokote Exterior Latex Wood Primer (B42WJ2003)
    - b. SW SuperPaint Exterior Latex Satin/Gloss (A89/A84 Series), 2 coats.
  - 3. Kelly-Moore Products: If any of the products below are discontinued, submit alternate products approved by the Manufacturer in writing.
    - a. KM premium Exterior Wood Primer, manufacturer's recommended type to suit conditions.
    - b. KM 1240 ACRY-SHIELD, flat, 2 coats.
    - c. KM 1245 ACRY-SHIELD, eggshell, 2 coats.
    - d. KM 1250 ACRY-SHIELD, semi-gloss, 2 coats.
- C. Paint CE-OP-3L - Masonry/Concrete, Opaque, Latex, 3 Coat:
- 1. One coat of block filler:
  - 2. Two coats of latex enamel. Sheen as selected by Architect.
  - 3. Kelly-Moore: If any of the products below are discontinued, submit alternate products approved by the Manufacturer in writing.
    - a. 521 FILL & PRIME.
    - b. 1250 ACRY-SHIELD, semi-gloss, or as required for selected sheen.
- D. Paint GE-OP-3L - Gypsum Board or Plaster, Opaque, Latex, 3 Coat:
- 1. One coat of urethane acrylic primer sealer.
  - 2. Two coats of latex enamel, sheen as selected by Architect.
  - 3. Kelly-Moore: If any of the products below are discontinued, submit alternate products approved by the Manufacturer in writing.
    - a. Kel Bond 295 Uniprime.

- b. 1245 ACRY-SHIELD or as required for selected sheen.
- 4. Sherwin-Williams: If any of the products below are discontinued, submit alternate products approved by the Manufacturer in writing.
  - a. Loxon Concrete & Masonry Primer, LX2W50
  - b. A-100 Exterior Latex Flat, A6 series, 2 coats.
  - c. A-100 Exterior Latex Satin, A82 series, 2 coats.
- E. Paint ME-OP-3A - Ferrous Metals, Primed or Unprimed, Alkyd, 3 Coat:
  - 1. One coat of alkyd primer.
  - 2. Two coats of alkyd enamel, or as required to achieve specified sheen and appearance.
  - 3. Kelly-Moore: If any of the products below are discontinued, submit alternate products approved by the Manufacturer in writing.
    - a. Rust-Oleum CV740, Alkyd Rust-Preventative White Primer for light finish colors; Rust-Oleum CV740, Alkyd Rust-Preventative Red Primer for dark finish colors.
    - b. 1998 Epic Water Urethane Modified Alkyd Semi-Gloss, 2 coats, or as required for selected sheen.
  - 4. Sherwin-Williams: If any of the products below are discontinued, submit alternate products approved by the Manufacturer in writing.
    - a. SW ProCryl Universal Primer B66-310
    - b. SW Pro Industrial Pre-Catalyzed Waterbased Urethane, B65-1100 or as required for selected sheen.
- F. Paint MgE-OP-3A - Galvanized Metals, Alkyd, 3 Coat:
  - 1. Pretreatment, reduce to minimum level for finish coat adhesion]. One coat .
  - 2. Prime Coat:
  - 3. Two coats of alkyd enamel, Gloss Sheen at exterior handrails and guardrails, Semi-gloss all other locations.
  - 4. Kelly-Moore Products: If any of the products below are discontinued, submit alternate products approved by the Manufacturer in writing.
    - a. Krud Kutter Metal Clean and Etch.
    - b. KM 5725 DTM Acrylic Primer/Finish.
    - c. KM 1999 Epic Water Urethane Modified Alkyd Gloss, 2 coats, or as required for selected sheen.
  - 5. Sherwin Williams Products: If any of the products below are discontinued, submit alternate products approved by the Manufacturer in writing.
    - a. Krud Kutter Metal Clean and Etch.
    - b. SW ProCryl Universal Primer B66-310.
    - c. SW Pro Industrial Acrylic Semi-gloss B66W651, 2 coats, or as required for selected sheen..

## 2.05 PRIMERS

- A. Primers: As required or recommended by manufacturer of top coats; where the manufacturer offers options on primers for a particular substrate, use primer categorized as "best" by the manufacturer.
  - 1. If products specified are discontinued, submit alternate product approved by specified Manufacturer in writing.

## 2.06 ACCESSORY MATERIALS

- A. Accessory Materials: Provide primers, sealers, cleaning agents, cleaning cloths, sanding materials, and clean-up materials as required for final completion of painted surfaces.
- B. Patching Material: Compatible with substrates, recommended by coating manufacturer in writing for conditions indicated.

- C. Sanding materials: 120-180 grit, for architectural woodwork, finish carpentry, wood doors, or other surfaces requiring touch-up.
- D. Fastener Head Cover Material: Latex filler.

### **PART 3 EXECUTION**

#### **3.01 EXAMINATION**

- A. Do not begin application of paints and finishes until substrates have been properly prepared.
- B. Verify that surfaces are ready to receive work as instructed by the product manufacturer.
- C. Examine surfaces scheduled to be finished prior to commencement of work. Report any condition that may potentially effect proper application.
- D. If substrate preparation is the responsibility of another installer, notify Architect of unsatisfactory preparation before proceeding.
- E. Test shop-applied primer for compatibility with subsequent cover materials.
- F. Measure moisture content of surfaces using an electronic moisture meter. Do not apply finishes unless moisture content of surfaces are below the manufacturer-recommended maximums.

#### **3.02 PROTECTION OF ADJACENT WORK**

- A. Protect surrounding elements from damage from painting procedures. Provide temporary facilities and barricades required. Additional requirements specified in Division 01.
- B. Carefully remove and store removable items located in areas to be painted, including fixtures, fittings, finish hardware, and accessories; reinstall upon completion.
- C. Separate areas to be protected from painting areas using means adequate to prevent damage.
- D. Cover existing landscaping with tarpaulins or similar covers.
- E. Mask immediately adjacent surfaces with material that will withstand cleaning and restoration procedures.
- F. Close off adjacent occupied areas with dust proof and weatherproof partitions.
- G. Protect roof membrane and flashings from damage with 1/2 inch (13 mm) plywood laid on roof surfaces over full extent of work area and traffic route.
- H. When using cleaning methods that involve water or other liquids, install drainage devices to prevent runoff over adjacent surfaces unless those surfaces are impervious to damage from runoff.

#### **3.03 PREPARATION**

- A. Clean surfaces thoroughly and correct defects prior to application.
- B. Prepare surfaces using the methods recommended by the manufacturer for achieving the best result for the substrate under the project conditions.
- C. Remove or repair existing paints or finishes that exhibit surface defects.
- D. Remove surface appurtenances, including electrical plates, hardware, light fixture trim, escutcheons, and fittings, prior to preparing surfaces for finishing.
- E. Surfaces: Correct defects and clean surfaces which affect work of this section. Feather-edge patches to make finished edges inconspicuous.



- F. Seal surfaces that might cause bleed through or staining of topcoat.
- G. Remove mildew from impervious surfaces by scrubbing with solution of tetra-sodium phosphate and bleach. Rinse with clean water and allow surface to dry.
- H. Provide barrier coats over incompatible primers, or remove and re-prime.
- I. Spot prime shop primed materials in field as required to assure that all surfaces are primed before finished coats are applied. Prime coats specified in this Section shall be provided in addition to shop prime coats on materials supplied for field finish.
- J. Verify compatibility of specified products with shop applied primer(s). In the event of incompatibility of products specified in the Section, recommend alternate compatible product for review.
- K. Provide full number of coats specified for each coating system indicated. Where recommended alternate compatible primers or undercoats require fewer coats than specified products, provide additional finish coat so that specified number of coats is not reduced.
- L. Concrete:
  - 1. Remove release agents, curing compounds, efflorescence, and chalk. Do not coat surfaces if moisture content or alkalinity of surfaces to be coated exceeds that permitted in manufacturer's written instructions.
  - 2. Prepare surface as recommended by top coat manufacturer and according to SSPC-SP 13.
- M. Masonry:
  - 1. Remove efflorescence and chalk. Do not coat surfaces if moisture content or alkalinity of surfaces or if alkalinity of mortar joints exceed that permitted in manufacturer's written instructions. Allow to dry.
  - 2. Prepare surface as recommended by top coat manufacturer.
- N. Exterior Plaster: Fill hairline cracks, small holes, and imperfections with exterior patching plaster. Make smooth and flush with adjacent surfaces. Wash and neutralize high alkali surfaces.
- O. Galvanized Surfaces:
  - 1. Remove surface contamination and oils and wash with solvent according to SSPC-SP 1.
  - 2. Prepare surface according to SSPC-SP 2.
- P. Ferrous Metal:
  - 1. Solvent clean according to SSPC-SP 1.
  - 2. Shop-Primed Surfaces: Sand and scrape to remove loose primer and rust. Feather edges to make touch-up patches inconspicuous. Clean surfaces with solvent. Prime bare steel surfaces. Re-prime entire shop-primed item.
  - 3. Remove rust, loose mill scale, and other foreign substances using using methods recommended in writing by paint manufacturer and blast cleaning according to SSPC-SP 6 "Commercial Blast Cleaning". Protect from corrosion until coated.
- Q. Exterior Wood Surfaces to Receive Opaque Finish: Remove dust, grit, and foreign matter. Seal knots, pitch streaks, and sappy sections. Fill nail holes with tinted exterior calking compound after prime coat has been applied. Back prime concealed surfaces before installation.
- R. Glue-Laminated Beams: Prior to finishing, wash surfaces with solvent, remove grease and dirt.
- S. Metal Doors to be Painted: Prime metal door top and bottom edge surfaces.

### **3.04 APPLICATION**

- A. Remove unfinished louvers, grilles, covers, and access panels on mechanical and electrical components and paint separately.
- B. Exterior Wood to Receive Opaque Finish: If final painting must be delayed more than 2 weeks after installation of woodwork, apply primer within 2 weeks and final coating within 4 weeks.
- C. Apply products in accordance with manufacturer's written instructions and recommendations in "MPI Architectural Painting Specification Manual". In the event of conflict, manufacturer recommendations to prevail.
- D. Where adjacent sealant is to be painted, do not apply finish coats until sealant is applied.
- E. Do not apply finishes to surfaces that are not dry. Allow applied coats to dry before next coat is applied. Do not re-coat until;
  - 1. Paint has dried until firm to the touch.
  - 2. Paint does not deform or feel sticky under moderate thumb pressure.
  - 3. Application of another coat of paint will not cause lifting or loss of adhesion of the undercoat.
- F. Apply each coat to uniform appearance.
- G. Dark Colors and Deep Clear Colors: Regardless of number of coats specified, apply additional coats until complete hide is achieved.
- H. Sand wood and metal surfaces lightly between coats to achieve required finish.
- I. Vacuum clean surfaces of loose particles. Use tack cloth to remove dust and particles just prior to applying next coat.
- J. Make work uniform without sags, runs, skips or brush marks. Make all edges sharp including interior intersections and transitions between split finishes.
- K. Backprime all concealed surfaces of finish carpentry, architectural woodwork, wood doors and unclad wood windows.
- L. Reinstall electrical cover plates, hardware, light fixture trim, escutcheons, and fittings removed prior to finishing.

### **3.05 FINISHING MECHANICAL AND ELECTRICAL EQUIPMENT**

- A. Paint shop-finished equipment (electrical panels, load centers, and similar elements) exposed to view. Factory coatings intended for finished exposure may remain in utility areas.
- B. Remove unfinished louvers, grilles, covers, and access panels on mechanical and electrical components and paint separately.
- C. Finish equipment, piping, conduit, and exposed duct work throughout in colors according to the color schedule.
- D. Reinstall electrical cover plates, hardware, light fixture trim, escutcheons, and fittings removed prior to finishing.

### **3.06 FIELD QUALITY CONTROL**

- A. See Section 01 4000 - Quality Requirements, for general requirements for field inspection.

**3.07 CLEANING**

- A. Collect waste material that could constitute a fire hazard, place in closed metal containers, and remove daily from site.
- B. Upon completion of work, clean window glass and other paint-spattered surfaces.

**3.08 PROTECTION**

- A. Protect finishes until completion of project.
- B. Touch-up damaged finishes after Substantial Completion.
  - 1. Remove spatters, spots, runs, sags, blemishes and other defects without marring adjacent unpainted surfaces.
  - 2. Repaint defective surfaces.
- C. Provide "Wet Paint" signs as required to protect newly-painted finishes.
- D. Adjusting: Following owner's move-in and occupancy at a time acceptable to the Owner, touch-up and adjust blemishes and other defects incurred by move-in operations and the actions of the Owner and their separate contractors. Limit: Two workers for two full days labor, per building.

**3.09 SCHEDULE - SURFACES TO BE FINISHED**

- A. Do Not Paint or Finish the Following Items:
  - 1. Items factory-finished unless otherwise indicated; materials and products having factory-applied primers are not considered factory finished.
  - 2. Items indicated to receive other finishes.
  - 3. Items indicated to remain unfinished.
  - 4. Fire rating labels, equipment serial number and capacity labels, and operating parts of equipment.
  - 5. Stainless steel, anodized aluminum, bronze, terne coated stainless steel, zinc, and lead items.
  - 6. Non-metallic roofing and flashing.
  - 7. Marble, granite, slate, and other natural stones.
  - 8. Ceramic and other types of tiles.
  - 9. Pre-finished wall, ceiling and floor materials or coverings, unless specifically scheduled for field painting.
  - 10. Floors, unless specifically indicated.
  - 11. Acrylic-Modified Cement Plaster Finish.
  - 12. Brick, glass unit masonry, architectural concrete, cast stone, integrally colored plaster and stucco unless specifically indicated.
  - 13. Glass.
  - 14. Concealed pipes, ducts, and conduits.
- B. General: Paint the surfaces described below under Schedule - Paint Systems. All surfaces exposed to weather, or visible to the eye, exterior and interior, unless specifically excluded by the Article titled "Do Not Paint or Finish the Following Items". If a coating system is not specified for a particular surface or substrate, provide a three-coat finish system recommended by the paint or coating manufacturer for that surface or substrate. Include all preparation necessary as appropriate for a similar substrate listed in the Article titled "PREPARATION", or preparation for that substrate as recommended by the paint or coating manufacturer.
- C. Mechanical and Electrical: Use paint systems defined for the materials to be finished.

1. Paint all conduit, insulated and exposed pipes, boxes, hangers, brackets, collars and supports, mechanical equipment, electrical equipment, and exposed ducts occurring in finished areas to match background surfaces, unless otherwise indicated.
  2. Paint all equipment, including that which is factory-finished, exposed to weather or to view on the roof and outdoors.
  3. Paint shop-primed items occurring in finished areas.
  4. Paint dampers exposed behind louvers, grilles, to match face panels.
- D. Paint behind moveable equipment and furniture.
- E. Finish top, bottom, and side edges of exterior doors the same as exposed faces.
- F. Paint access doors, fire hose and extinguisher cabinets, panelboards, conduits and exposed plumbing piping.
- G. Paint reveal moldings, expansion joints, and handrails.
- H. Paint tube column and miscellaneous connections.
- I. Provide split finishes for painted doors and interior windows where different connected room colors are selected.
- J. Paint continuous surfaces with the same paint system. Do not change systems at elevation breaks.
- K. Touch-up factory paint finishes where damaged.

### **3.10 SCHEDULE - PAINT SYSTEMS**

- A. Concrete: Finish only surfaces exposed to view which are indicated to receive paint.
1. Exterior: Flat sheen.
- B. Plaster: Finish all surfaces exposed to view, except plaster with acrylic-modified finish per Section 09 2513..
1. Exterior Walls and surfaces, including soffits, (Stucco): GE-OP-3L
- C. Wood: Finish all surfaces exposed to view.
1. Exterior trim, beams, soffits and frames: WE-OP-3L.
    - a. Semi-gloss sheen.
- D. Steel Doors and Frames: Finish all surfaces exposed to view and to weather, including door tops and bottoms. Select prime coats compatible with finish color selections.
1. Semi-gloss sheen.
- E. Metal Fabrications: Finish all surfaces exposed to view and concealed, before installation.. Select prime coats compatible with finish color selections.
1. Exterior - Handrails and Guardrails: Gloss sheen.
  2. Exterior - All Other Surfaces: Semi-gloss sheen.
- F. Galvanized Steel and Shop-Primed Metal Items: Exterior and Interior; Finish all surfaces exposed to view and to weather, including plaster joints and accessories, exposed portions of roof deck systems.
1. Exterior - Handrails and Guardrails: Gloss sheen.
  2. Exterior - All Other Surfaces: Semi-gloss sheen.
- G. Miscellaneous metals, conduits, non-factory-finished access panels: As specified for either unprimed or shop primed metals, modified as required to make sheen match adjacent surfaces. Finish the following items:
1. Exposed portions of metal roof deck assemblies.
  2. Exposed surfaces of lintels.
  3. Exposed surfaces of steel stairs, ladders, fences, gates and railings.

4. Mechanical and electrical equipment.

H. Exterior Pavement Markings: As specified in related Division 32 section.

### 3.11 SCHEDULE - COLORS

A. Building and Structure Exteriors: Allow individual Schedule with separate color selections for each Building:

1. Walls; Field color as selected.
2. Ceilings/soffits; as selected.
3. Wainscot; as selected, allow for deep tones.
4. Accent walls; as selected, allow for deep tones.
5. Paint access doors and panels same as walls/wainscots.
6. Wood Trim; as selected, allow for deep tones.
7. Accent members; as selected, allow for deep tones.
8. Doors and Frames; as selected, allow for deep tones and split finishes exterior/interior.
9. Guardrails, handrails; as selected.
10. Fences, gates; as selected.
11. Rainwater leaders; as selected to match walls or gutters.
12. Mechanical and electrical units and ductwork exposed to view; match wall/wainscot or as selected.

B. Site Work:

1. Vehicle Barriers, Bollards and Gates: Paint OSHA "Hi-Visibility" Yellow.
2. Domestic, Fire and Irrigation Water Service Piping and Valves: Paint above-ground portions selected color.
3. Playground Equipment: Paint vertical posts of permanent basketball goals, volleyball net posts, tetherball poles OSHA "Hi-Visibility" Yellow.

**END OF SECTION**

**SECTION 09 9123**  
**INTERIOR PAINTING**

**PART 1 GENERAL**

**1.01 SECTION INCLUDES**

- A. Surface preparation.
- B. Field application of paints.
- C. Materials for backpriming woodwork.
- D. Scope: Finish interior surfaces exposed to view, unless fully factory-finished and unless otherwise indicated.
  - 1. Both sides and edges of plywood backboards for electrical and telecom equipment before installing equipment.
  - 2. Prime surfaces to receive wall coverings.
  - 3. Mechanical and Electrical:
    - a. In finished areas, paint insulated and exposed pipes, conduit, boxes, insulated and exposed ducts, hangers, brackets, collars and supports, mechanical equipment, and electrical equipment, unless otherwise indicated.
    - b. In finished areas, paint shop-primed items.
    - c. Paint interior surfaces of air ducts that are visible through grilles and louvers with one coat of flat black paint to visible surfaces.
    - d. Paint dampers exposed behind louvers, grilles, and convactor and baseboard cabinets to match face panels.

**1.02 RELATED REQUIREMENTS**

- A. Section 01 6116 - Volatile Organic Compound (VOC) Content Restrictions.
- B. Pertinent sections of Division 05 specifying shop-primed and galvanized metal items.

**1.03 DEFINITIONS**

- A. Comply with ASTM D16 for interpretation of terms used in this section.

**1.04 REFERENCE STANDARDS**

- A. 40 CFR 59, Subpart D - National Volatile Organic Compound Emission Standards for Architectural Coatings; U.S. Environmental Protection Agency; current edition.
- B. ASTM D16 - Standard Terminology for Paint, Related Coatings, Materials, and Applications; 2014.
- C. Manufacturer's recommendations and specifications, including installation instructions.
- D. MPI (APSM) - Master Painters Institute Architectural Painting Specification Manual; Current Edition, [www.paintinfo.com](http://www.paintinfo.com).
- E. SSPC-SP 1 - Solvent Cleaning; 2015.
- F. SSPC-SP 2 - Hand Tool Cleaning; 1982 (Ed. 2004).
- G. SSPC-SP 6 - Commercial Blast Cleaning; 2007.
- H. SSPC-SP 13 - Surface Preparation of Concrete; (Reaffirmed 2015); 2003.

**1.05 SUBMITTALS**

- A. See Section 01 3300 - Submittals, for submittal procedures.

- B. Product Data: Provide complete list of products to be used, with the following information for each:
  - 1. Manufacturer's name, product name and/or catalog number, and general product category (e.g. "alkyd enamel").
  - 2. MPI product number (e.g. MPI #47).
  - 3. Cross-reference to specified paint system(s) product is to be used in; include description of each system.
  - 4. Manufacturer's installation instructions.
  - 5. If proposal of substitutions is allowed under submittal procedures, explanation of substitutions proposed.
  - 6. Resin Type.
  - 7. Total VOC Content in grams per liter.
  - 8. Solids Content By Volume SCBV (not solids by weight). All products shall be minimum 35% SCBV.
  - 9. Composition-By-Weight. Demonstrate composition by percentage related to total weight of all components.
  - 10. Film Thickness Per Coat, Wet and Dry.
  - 11. Prime Pigment: Demonstrate prime pigment by percentage related to total volume of all components.
- C. Samples: Submit three paper "draw down" samples, 8-1/2 by 11 inches (216 by 279 mm) in size, illustrating range of colors available for each finishing product specified.
  - 1. Where sheen is specified, submit samples in only that sheen.
  - 2. Where sheen is not specified, discuss sheen options with Architect before preparing samples, to eliminate sheens definitely not required.
  - 3. Allow 30 days for approval process, after receipt of complete samples by Architect.
  - 4. Paint color submittals will not be considered until color submittals for major materials not to be painted, such as factory finished metals, wood cabinets, wood doors, and wall coverings and tile, have been approved.
- D. Certification: By manufacturer that paints and finishes comply with VOC limits specified.
- E. Manufacturer's Instructions: Indicate special surface preparation procedures.
- F. Maintenance Data: Submit data including finish schedule showing where each product/color/finish was used, product technical data sheets, material safety data sheets (MSDS), care and cleaning instructions, touch-up procedures, repair of painted and finished surfaces, and color samples of each color and finish used.
- G. Maintenance Materials: Furnish the following for Owner's use in maintenance of project.
  - 1. See Section 01 6000 - Product Requirements, for additional provisions.
  - 2. Extra Paint and Finish Materials: 1 gallon (4 L) of each color; from the same product run, store where directed.
  - 3. Label each container with color in addition to the manufacturer's label.

#### **1.06 QUALITY ASSURANCE**

- A. Manufacturer Qualifications: Company specializing in manufacturing the products specified, with minimum ten (10) years documented experience.
- B. Applicator Qualifications: Company specializing in performing the type of work specified with minimum five (5) years experience and approved by manufacturer.

#### **1.07 MOCK-UP**

- A. See Section 01 4000 - Quality Requirements, for general requirements for mock-up.

- B. Provide panel, 8 feet (\_\_\_\_ m) long by 10 feet (\_\_\_\_ m) wide, illustrating paint color, texture, and finish.
- C. Provide door and frame assembly illustrating paint color, texture, and finish.
- D. Locate where directed by Architect.
- E. Final color selections and acceptance will be made only after review of mock-ups under lighting conditions approximating finish conditions.
- F. Mock-up may remain as part of the work.

#### **1.08 DELIVERY, STORAGE, AND HANDLING**

- A. Deliver products to site in sealed and labeled containers; inspect to verify acceptability.
- B. Container Label: Include manufacturer's name, type of paint, brand name, lot number, brand code, coverage, surface preparation, drying time, cleanup requirements, color designation, and instructions for mixing and reducing.
- C. Paint Materials: Store at minimum ambient temperature of 45 degrees F (7 degrees C) and a maximum of 90 degrees F (32 degrees C), in ventilated area, and as required by manufacturer's instructions.

#### **1.09 FIELD CONDITIONS**

- A. Do not apply materials when surface and ambient temperatures are outside the temperature ranges required by the paint product manufacturer.
- B. Follow manufacturer's recommended procedures for producing best results, including testing of substrates, moisture in substrates, and humidity and temperature limitations.
- C. Provide lighting level of 80 ft candles (860 lx) measured mid-height at substrate surface.

### **PART 2 PRODUCTS**

#### **2.01 MANUFACTURERS**

- A. Provide paints and finishes used in any individual system from the same manufacturer; no exceptions.
- B. Paints:
  - 1. Sherwin-Williams Company: [www.sherwin-williams.com/#sle](http://www.sherwin-williams.com/#sle).
- C. Primer Sealers: Same manufacturer as top coats.
- D. Substitutions: See Section 01 6000 - Product Requirements.

#### **2.02 PAINTS AND FINISHES - GENERAL**

- A. Paints and Finishes: Ready mixed, unless intended to be a field-catalyzed paint.
  - 1. Provide paints and finishes of a soft paste consistency, capable of being readily and uniformly dispersed to a homogeneous coating, with good flow and brushing properties, and capable of drying or curing free of streaks or sags.
  - 2. Provide materials that are compatible with one another and the substrates indicated under conditions of service and application, as demonstrated by manufacturer based on testing and field experience.
  - 3. For opaque finishes, tint each coat including primer coat and intermediate coats, one-half shade lighter than succeeding coat, with final finish coat as base color.
  - 4. Supply each paint material in quantity required to complete entire project's work from a single production run.



5. Do not reduce, thin, or dilute paint or finishes or add materials unless such procedure is specifically described in manufacturer's product instructions.
- B. Volatile Organic Compound (VOC) Content: Comply with Section 01 6116.
- C. Flammability: Comply with applicable code for surface burning characteristics.
- D. Sheens: Provide the sheens specified; where sheen is not specified, sheen will be selected later by Architect from the manufacturer's full line.
- E. Colors: To be selected from manufacturer's full range of available colors.
  1. Selection to be made by Architect after award of contract.
  2. Allow for minimum of three colors for each system, unless otherwise indicated, without additional cost to Owner.
  3. Extend colors to surface edges; colors may change at any edge as directed by Architect.
  4. In finished areas, finish pipes, ducts, conduit, and equipment the same color as the wall/ceiling they are mounted on/under.
  5. In utility areas, finish equipment, piping, conduit, and exposed duct work in colors according to the color coding scheme indicated.

### **2.03 PAINT SYSTEMS - INTERIOR - CONCRETE AND MASONRY**

- A. Paint CI-OP-3L - Concrete/Masonry, Opaque, Latex, 3 Coat:
  1. One coat of block filler.
  2. Two coats of latex enamel; sheen selected by Architect.
  3. If any of the products below are discontinued, submit alternate products approved by the Manufacturer in writing.
  4. Kelly Moore Products:
    - a. CMU: KM 521 FILL & PRIME Acrylic Block Filler.
    - b. Concrete: KM 971 Acryplex Low VOC Interior Interior PVA Primer/Sealer.
    - c. KM 1650 ACRY-PLEX Interior 100% Acrylic Enamel Series.

### **2.04 PAINT SYSTEMS - INTERIOR - METALS**

- A. Paint MI-OP-3A - Ferrous Metals, Primed or Unprimed, Alkyd, 3 or 4 Coat:
  1. One coat of alkyd primer:
  2. Two (or more) coats of Alkyd Enamel, as required to achieve specified appearance. Provide sheen as specified and number of coats as required to achieve specified appearance; Gloss ( Handrails and Guardrails), Semi-gloss (All other surfaces). Sheen selected by Architect.
  3. If any of the products below are discontinued, submit alternate products approved by the Manufacturer in writing.
  4. Kelly-Moore Products:
    - a. Devoe Devprime 1405 Alkyd Metal Primer.
    - b. Two coats, KM Professional Water-Oil Hybrid Series 1930 Int/Ext Semi-Gloss Enamel or as required for specified sheen.
- B. Paint MI-OP-3L - Ferrous Metals, Primed or Unprimed, Latex, 3 Coat: Surfaces 8 feet or more above finish floor, trusses, metal roof deck, ductwork.
  1. One coat of alkyd primer:
  2. 2 coats of latex enamel; sheen as selected by Architect.
  3. If any of the products below are discontinued, submit alternate products approved by the Manufacturer in writing.
  4. Kelly-Moore Products:
    - a. KM 5725 DTM Acrylic Primer/Finish.
    - b. KM 1680 Series DURA-POXY + 100% Acrylic Enamel.
- C. Paint MgI-OP-3A - Galvanized Metals, Alkyd, 3 Coat:

1. Pretreatment: reduce to minimum level for finish coat adhesion.
  2. One coat alkyd metal primer.
  3. Two coats of alkyd enamel, sheen as selected by Architect.
  4. If any of the products below are discontinued, submit alternate products approved by the Manufacturer in writing.
  5. Kelly Moore Products:
    - a. Devprep 88 Surface Cleaner & Degreaser.
    - b. KM 5725 DTM Primer / Finish.
    - c. KM 1980 Series Professional Water Urethane Modified Alkyd Enamel.
- D. Paint MgI-OP-3L - Galvanized Metals, Latex, 3 Coats: Surfaces 8 feet or more above finished floor, metal roof deck, ductwork, etc.
1. Pretreatment: Solvent wash to remove oily residue, ensure finish coat adhesion.
  2. One Coat Galvanized Primer.
  3. Two Coats Latex Enamel; sheen as selected by Architect
  4. If any of the products below are discontinued, submit alternate products approved by the Manufacturer in writing.
  5. Kelly Moore Products:
    - a. Pretreatment as recommended by topcoat manufacturer.
    - b. KM 5725 DTM Acrylic Primer / Finish.
    - c. KM 5885 Series DTM High Performance Acrylic Enamel.

## 2.05 PAINT SYSTEMS - INTERIOR - WOOD

- A. Paint WI-OP-3L - Wood, Opaque, Latex, Low-VOC 3 Coat: Cedar, redwood, architectural glue-laminated beams, typical interior wood trim with opaque finish. Provide number of coats necessary for stain resistance and uniform color.
1. One coat of latex primer sealer.
  2. Two coats of latex enamel; . Sheen selected by Architect.
  3. Kelly-Moore Products:
    - a. KM 973 Acryplex Low VOC Interior Enamel Undercoat.
    - b. KM 1050 Series Premium Professional Low VOC Interior Acrylic Latex.
- B. Paint WI-OP-3L - Wood, Opaque, Latex, 3 Coat: Typical exposed interior beams above 8'-0".
1. One coat of latex primer sealer.
  2. Two coats of latex enamel. Sheen selected by Architect.
  3. If any of the products below are discontinued, submit alternate products approved by the Manufacturer in writing.
  4. Kelly-Moore Products:
    - a. Kelly-Moore: 973 Acry-Plex Zero VOC Interior Undercoat .
    - b. Kelly-Moore: "KM 1010 Premium Professional Zero VOC Eggshell Enamel".
- C. Wood to Receive Transparent Finishes: Finish as specified in related Section 09 9300.
- D. Paint SWI-P-3L - Synthetic Wood (Hardboard, "Masonite"), Floor Paint, 3 coat.
1. Prime Coat.
  2. Two Coats: Porch and Deck Paint, epoxy-modified acrylic. Sheen selected by Architect.
  3. If any of the products below are discontinued, submit alternate products approved by the Manufacturer in writing.
  4. Kelly-Moore: 1786 DuraPoxy+Acrylic Porch Floor Eggshell Enamel.
    - a. KM 1786 Dura - Poxyl+Acrylic Porch and Floor Eggshell Enamel (thin 20% for priming).
    - b. KM 1786 DuraPoxy+Acrylic Porch Floor Eggshell Enamel.

## 2.06 PAINT SYSTEMS - INTERIOR - GYPSUM AND PLASTER

- A. Paint GI-OP-3E - Gypsum Board, Plaster, Epoxy, 3 Coat:

1. One coat of synthetic resin primer sealer, quick dry, pigmented.
  2. Two coats of two-component acrylic epoxy enamel; Semi-gloss sheen, or as selected by Architect.
  3. If any of the products below are discontinued, submit alternate products approved by the Manufacturer in writing.
  4. Kelly Moore Products:
    - a. KM MonoChem Aqua Prime Primer
    - b. KM MonoChem 200 WB Epoxy Coating
- B. Paint GI-OP-3A-L Gypsum Board/Plaster, Acrylic, Low-VOC, 3 Coat:
1. One coat of low odor/low-VOC vinyl acrylic primer sealer: pigmented.
  2. Two coats of low odor / low-VOC acrylic, sheen as selected by Architect.
  3. Note: Surfaces that prepared to a Level 5 Finish, using the Level 5 Primer/Prep Coat as specified in Section 09 2116 "Gypsum Board Assemblies", may omit primer coat specified above when topcoat manufacturer confirms in writing that this primer is compatible with the finish coats as specified.
  4. If any of the products below are discontinued, submit alternate products approved by the Manufacturer in writing.
  5. Kelly Moore Products:
    - a. KM 971 Acry-Plex Low VOC Interior PVA Primer/Sealer.
    - b. KM 1010 Premium Professional Interior 100% Acrylic Enamel Series.
- C. Paint GI-P-1A - Gypsum Board/Plaster, Alkyd Primer, 1 Coat: Preparation for application of Wall Covering.
1. One coat of primer sealer.
  2. If any of the products below are discontinued, submit alternate products approved by the Manufacturer in writing.
  3. Kelly Moore Products:
    - a. KM 265 Water-Oil Hybrid Int/Ext Primer Undercoat.

## **2.07 PRIMERS**

- A. Primers: As required or recommended by manufacturer of top coats; where the manufacturer offers options on primers for a particular substrate, use primer categorized as "best" by the manufacturer.
1. If products specified are discontinued, submit alternate product approved by specified Manufacturer in writing.

## **2.08 ACCESSORY MATERIALS**

- A. Accessory Materials: Provide primers, sealers, cleaning agents, cleaning cloths, sanding materials, and clean-up materials as required for final completion of painted surfaces.
- B. Sanding materials: 120-180 grit, for architectural woodwork, finish carpentry, wood doors, or other surfaces requiring touch-up.
- C. Patching Material: Latex filler.
- D. Fastener Head Cover Material: Latex filler.

## **PART 3 EXECUTION**

### **3.01 EXAMINATION**

- A. Do not begin application of paints and finishes until substrates have been properly prepared.
- B. Verify that surfaces are ready to receive work as instructed by the product manufacturer.
- C. Examine surfaces scheduled to be finished prior to commencement of work. Report any condition that may potentially effect proper application.

- D. If substrate preparation is the responsibility of another installer, notify Architect of unsatisfactory preparation before proceeding.
- E. Test shop-applied primer for compatibility with subsequent cover materials.
- F. Measure moisture content of surfaces using an electronic moisture meter. Do not apply finishes unless moisture content of surfaces are below the manufacturer-recommended maximums.

### **3.02 PROTECTION OF ADJACENT WORK**

- A. Protect surrounding elements from damage from painting procedures. Provide temporary facilities and barricades required. Additional requirements specified in Division 01.
- B. Carefully remove and store removable items located in areas to be painted, including fixtures, fittings, finish hardware, and accessories; reinstall upon completion.
- C. Separate areas to be protected from painting areas using means adequate to prevent damage.
- D. Cover existing interior planters and landscaping with tarpaulins or similar covers.
- E. Mask immediately adjacent surfaces with material that will withstand cleaning and restoration procedures.

### **3.03 PREPARATION**

- A. Clean surfaces thoroughly and correct defects prior to application.
- B. Prepare surfaces using the methods recommended by the manufacturer for achieving the best result for the substrate under the project conditions.
- C. Remove or repair existing paints or finishes that exhibit surface defects.
- D. Remove or mask surface appurtenances, including electrical plates, hardware, light fixture trim, escutcheons, and fittings, prior to preparing surfaces or finishing.
- E. Seal surfaces that might cause bleed through or staining of topcoat.
- F. Remove mildew from impervious surfaces by scrubbing with solution of tetra-sodium phosphate and bleach. Rinse with clean water and allow surface to dry.
- G. Concrete:
  - 1. Remove release agents, curing compounds, efflorescence, and chalk. Do not coat surfaces if moisture content or alkalinity of surfaces to be coated exceeds that permitted in manufacturer's written instructions.
  - 2. Prepare surface as recommended by top coat manufacturer and according to SSPC-SP 13.
- H. Gypsum Board: Fill minor defects with filler compound. Spot prime defects after repair.
- I. Plaster: Fill hairline cracks, small holes, and imperfections with latex patching plaster. Make smooth and flush with adjacent surfaces. Wash and neutralize high alkali surfaces.
- J. Tackable Substrates for Wall Coverings: Prepare as for gypsum board.
- K. Galvanized Surfaces:
  - 1. Remove surface contamination and oils and wash with solvent according to SSPC-SP 1.
  - 2. Prepare surface according to SSPC-SP 2.
- L. Ferrous Metal:
  - 1. Solvent clean according to SSPC-SP 1.

2. Shop-Primed Surfaces: Sand and scrape to remove loose primer and rust. Feather edges to make touch-up patches inconspicuous. Clean surfaces with solvent. Prime bare steel surfaces. Re-prime entire shop-primed item.
  3. Remove rust, loose mill scale, and other foreign substances using methods recommended in writing by paint manufacturer and blast cleaning according to SSPC-SP 6 "Commercial Blast Cleaning". Protect from corrosion until coated.
- M. Wood Surfaces to Receive Opaque Finish: Wipe off dust and grit prior to priming. Seal knots, pitch streaks, and sappy sections with sealer. Fill nail holes and cracks after primer has dried; sand between coats. Back prime concealed surfaces before installation.
- N. Glue-Laminated Beams: Prior to finishing, wash surfaces with solvent, remove grease and dirt.
- O. Metal Doors to be Painted: Prime metal door top and bottom edge surfaces.

### 3.04 PREPARATION - EXISTING SURFACES

- A. General: As specified above and as follows below.
- B. Remove or repair existing coatings that exhibit surface defects. Feather-edge patches to make finished edges inconspicuous.
- C. Existing Cement Plaster Surfaces to be Painted: Remove dirt, loose mortar, scale, salt or alkali powder, and other foreign matter. Remove oil and grease with a solution of tri-sodium phosphate; rinse well and allow to dry. Surfaces to be clean, dry, free of dirt, dust, grease, oil, mildew, efflorescence and other contaminants affecting paint adhesion or performance. Completely remove all loose, peeling or checked paints by power-washing, scraping or other methods. Spot-prime and point-up cracks, voids or other surface fissures by methods recommended by paint manufacturer. Spot-prime again following patching. Remove stains caused by weathering of corroding metals with a solution of sodium metasilicate after thoroughly wetting with water. Allow to dry.
- D. Existing Gypsum Board Surfaces to be Painted: Remove dirt, loose texturing, scale, salt or alkali powder, and other foreign matter. Remove oil and grease with a solution of tri-sodium phosphate; rinse well and allow to dry. Surfaces to be clean, dry, free of dirt, dust, grease, oil, mildew, efflorescence and other contaminants affecting paint adhesion or performance. Completely remove all loose, peeling or checked paints by sanding, scraping or other methods. Fill all holes and defects with suitable patching or spackling material compatible with the substrate material, allow to completely dry and sand to approximate existing adjacent textures. Spot prime patched areas.
- E. Existing Metal Surfaces With Existing Coatings to be Recoated; sheet metal flashings and trim, hollow metal doors, frames, columns and similar items. Sand and scrape to remove existing finishes, loose primer and rust. Clean surfaces with solvent. Prime bare metal surfaces. Feather edges to make touch-up patches inconspicuous.
- F. Existing Wood to Receive Opaque Finish: Completely remove all loose, peeling chalking, flaking or peeling paint by pressure-washing, scraping, wire brushing, sanding or other appropriate methods which will not damage existing substrates or adjacent finishes. Dull glossy surfaces to provide roughened surface for proper adhesion. Remove all loose sealant and glazing compounds. Feather back rough paint edges and weathered wood material by sanding. Spot prime all areas before and after application of new sealants, patching or glazing materials. Remove dust, grit, and foreign matter. Seal knots, pitch streaks, and sappy sections. Fill nail holes with tinted exterior sealant compound after prime coat has been applied. Remove mildew growth as recommended by paint manufacturer.

- G. Existing Metal Doors to be Painted Sand, patch, clean with solvent. Prime metal door top and bottom edge surfaces. Finish otherwise as for Existing Metal Surfaces With Existing Coatings to be Recoated.

### **3.05 APPLICATION**

- A. Remove unfinished louvers, grilles, covers, and access panels on mechanical and electrical components and paint separately.
- B. Apply products in accordance with manufacturer's written instructions and recommendations in "MPI Architectural Painting Specification Manual".
- C. Where adjacent sealant is to be painted, do not apply finish coats until sealant is applied.
- D. Do not apply finishes to surfaces that are not dry. Allow applied coats to dry before next coat is applied.
- E. Apply each coat to uniform appearance in thicknesses specified by manufacturer.
- F. Dark Colors and Deep Clear Colors: Regardless of number of coats specified, apply as many coats as necessary for complete hide.
- G. Sand wood and metal surfaces lightly between coats to achieve required finish.
- H. Vacuum clean surfaces of loose particles. Use tack cloth to remove dust and particles just prior to applying next coat.
- I. Reinstall electrical cover plates, hardware, light fixture trim, escutcheons, and fittings removed prior to finishing.

### **3.06 FIELD QUALITY CONTROL**

- A. See Section 01 4000 - Quality Requirements, for general requirements for field inspection.

### **3.07 CLEANING**

- A. Collect waste material that could constitute a fire hazard, place in closed metal containers, and remove daily from site.

### **3.08 PROTECTION**

### **3.09 SCHEDULE - SURFACES TO BE FINISHED**

- A. Do Not Paint or Finish the Following Items:
  - 1. Items factory-finished unless otherwise indicated; materials and products having factory-applied primers are not considered factory finished.
  - 2. Items indicated to receive other finishes.
  - 3. Items indicated to remain unfinished.
  - 4. Fire rating labels, equipment serial number and capacity labels, and operating parts of equipment.
  - 5. Stainless steel, anodized aluminum, bronze, terne coated stainless steel, zinc, and lead items.
  - 6. Marble, granite, slate, and other natural stones.
  - 7. Ceramic and other types of tiles.
  - 8. Pre-finished wall, ceiling and floor materials or coverings, unless specifically scheduled for field painting.
  - 9. Floors, unless specifically indicated.
  - 10. Brick, glass unit masonry, architectural concrete, cast stone, integrally colored plaster and stucco unless specifically indicated.
  - 11. Glass.

12. Concealed pipes, ducts, and conduits.

- B. General: Paint the surfaces described below under Schedule - Paint Systems. All surfaces exposed to weather, or visible to the eye, exterior and interior, unless specifically excluded by the Article titled "Do Not Paint or Finish the Following Items". If a coating system is not specified for a particular surface or substrate, provide a three-coat finish system recommended by the paint or coating manufacturer for that surface or substrate. Include all preparation necessary as appropriate for a similar substrate listed in the Article titled "PREPARATION", or preparation for that substrate as recommended by the paint or coating manufacturer.
- C. Mechanical and Electrical: Use paint systems defined for the materials to be finished.
  - 1. Paint all conduit, insulated and exposed pipes, boxes, hangers, brackets, collars and supports, mechanical equipment, electrical equipment, and exposed ducts occurring in finished areas to match background surfaces, unless otherwise indicated.
  - 2. Paint all equipment, including that which is factory-finished, exposed to weather or to view on the roof and outdoors.
  - 3. Paint shop-primed items occurring in finished areas.
  - 4. Paint interior surfaces of air ducts that are visible through grilles and louvers with one coat of flat black paint to visible surfaces.
  - 5. Paint dampers exposed behind louvers, grilles, to match face panels.
- D. Paint behind moveable equipment and furniture.
- E. Finish top, bottom, and side edges of interior doors the same as exposed faces.
- F. Paint access doors, fire hose and extinguisher cabinets, panelboards, conduits and exposed plumbing piping.
- G. Paint all exposed and semi-exposed galvanized metal, projections through and on roofs.
- H. Paint reveal moldings, expansion joints, and handrails.
- I. Paint tube column and miscellaneous connections.
- J. Provide split finishes for painted doors and interior windows where different connected room colors are selected.
- K. Paint continuous surfaces with the same paint system. Do not change systems at elevation breaks.
- L. Touch-up factory paint finishes where damaged.
- M. Paint both sides and edges of plywood backboards for electrical and telephone equipment before installing equipment.

**3.10 SCHEDULE - PAINT SYSTEMS**

- A. Gypsum Board: Finish all surfaces exposed to view, GI-OP-3A..
  - 1. Interior Ceilings and Bulkheads: Flat sheen.
  - 2. Interior Walls: Semi-gloss Sheen at Toilet Rooms, Custodians, Storage Room, Food Service.
  - 3. Interior Walls: Eggshell at Classrooms, Corridors, Administrative Offices and Work Rooms.
- B. Wood: Finish all surfaces exposed to view.
  - 1. Interior Opaque Finish: WI-OP-3L
    - a. Trim and frames: Semi-gloss sheen.
    - b. Beams: Low Sheen.
- C. New Wood Doors: Factory-finished.

- D. Steel Doors and Frames: Finish all surfaces exposed to view and to weather, including door tops and bottoms. Select prime coats compatible with finish color selections. MI-OP-3A.
  - 1. Semi-gloss sheen.
- E. Metal Fabrications, Galvanized Steel and Shop-Primed Metal Items: Finish all surfaces exposed to view and concealed, before installation, including exposed portions of metal roof or floor deck assemblies.. Select prime coats compatible with finish color selections. MI-OP-3A for surfaces under 8 feet above floor. MI-OP-3L for surfaces over 8 feet above floor.
  - 1. Interior - Handrails and exposed spiral seamed ductwork: Gloss sheen.
  - 2. Interior - All Other Surfaces: Semi-gloss sheen.
- F. Miscellaneous metals, conduits, non factory finished access panels: As specified for either unprimed or shop primed metals, modified as required to make sheen match adjacent surfaces.
  - 1. Finish the following items:
    - a. Exposed portions of metal roof and floor deck assemblies.
    - b. Exposed surfaces of lintels.
    - c. Exposed surfaces of steel stairs, ladders, fences, gates and railings.
    - d. Mechanical equipment.
    - e. Electrical equipment.
- G. Wall and Substrate Surfaces Under Wall Covering: GI-P-1A.

### 3.11 SCHEDULE - COLORS

- A. Interiors, allow individual schedule for each Building:
  - 1. Walls; Field color as selected.
  - 2. Ceilings/soffits; as selected, allow for deep tones.
  - 3. Wainscot; as selected, allow for deep tones.
  - 4. Accent walls; as selected, allow for deep tones.
  - 5. Paint access doors and panels same as walls and wainscots.
  - 6. Wood Trim; as selected, allow for deep tones.
  - 7. Accent members; as selected, allow for deep tones.
  - 8. Doors and Frames; as selected, allow for deep tones and split finishes exterior/interior.
  - 9. Doors and Frames for Utility or staff access only, as selected; match walls/wainscot.
  - 10. Guardrails, handrails; as selected.
  - 11. Exposed trusses or structural members; as selected, allow for deep tones.
  - 12. Exposed ductwork; as selected, allow for deep tones.
  - 13. Mechanical or other equipment exposed to view; as selected or match wall/wainscot as directed.

END OF SECTION



**SECTION 09 9623**  
**ANTI-GRAFFITI COATINGS**

**PART 1 GENERAL**

**1.01 SECTION INCLUDES**

- A. Clear anti-graffiti coating for exterior surfaces.

**1.02 RELATED SECTIONS**

- A. Section 07 9200 - Joint Sealers.
- B. Section 09 2513 - Acrylic-Modified Portland Cement Plaster.

**1.03 SYSTEM DESCRIPTION**

- A. Anti-Graffiti Coating System: Clear, deep penetrating, non-film forming, non-yellowing, heavy duty, chemical water and graffiti repellent solutions.
- B. All products VOC - compliant to air quality standards prevailing at the project site.

**1.04 SUBMITTALS**

- A. See Section 01 3300 - Submittals, for submittal procedures.
- B. Product Data: Manufacturer's current technical data sheets for materials, and schedule indicating:
  - 1. Recommended waterproof coating serving as base layer of system;
  - 2. Number of coats required for subsequent coating types.
- C. Manufacturer's Field Reports: Indicate installation procedures, coverage, quantities, progress, unacceptable conditions and methods of resolution.
- D. Maintenance Data: Provide manufacturer's recommended maintenance procedures, including instructions for graffiti removal, recommended procedures for re-application of intermediate coatings and periodic maintenance of coating.
- E. Warranty: Submit manufacturer warranty and ensure that forms have been completed in Owner 's name and registered with manufacturer.

**1.05 QUALITY ASSURANCE**

- A. Mock-Up or Test Panels: Before full-scale application, test products to be used on a mock-up or test panels.
  - 1. Review manufacturer's product data sheets to determine suitability of each product for each surface.
  - 2. Apply products using manufacturer-approved application methods, determining actual requirements for surface preparation, coverage rate, number of coats, and application procedures.
  - 3. After 48 hours, review effectiveness of protection, compatibility with substrates, and ability to achieve desired results.
  - 4. Obtain approval by Architect and Owner of workmanship, color, and texture before proceeding with work.
  - 5. Test Panels: Inconspicuous sections of actual construction.
    - a. Location and number as selected by Architect.
    - b. Size: 4 feet by 4 feet (1220 by 1220 m).
    - c. Repair unacceptable work to the satisfaction of the Architect and Owner.

- B. Pre-Installation Meetings:
  - 1. Before Application: Installer and Manufacturer's Representative shall inspect surfaces to be treated, noting in writing to the Architect, deficiencies or flaws in the substrate construction which would affect the performance or appearance of the coating.
  - 2. Beginning of Application: Manufacturer's Representative shall assure utilization of proper equipment, verify material quantities, and supervise material application techniques.
- C. Installer shall comply with recommendations and instructions set forth by manufacturer as part of manufacturer's service in addition to complying with the terms of the warranty.
- D. Installer Qualifications: Minimum 5 years of experience regularly engaged and specializing in the application of specialty surface treatments to exterior wall substrates.
- E. Do not proceed with material application until all deficiencies noted in pre-application inspection report have been corrected.
- F. Notify manufacturer no less than 72 hours before starting application.

#### **1.06 DELIVERY, STORAGE, AND HANDLING**

- A. Deliver materials in original sealed containers, clearly marked with manufacturer's name, type of material, and batch number.
- B. Inspect the materials upon delivery to assure that specified products have been received.
- C. Store materials where temperatures are not less than 45 degree F. (7 degrees C).
- D. Use all means necessary to protect material before, during, and after installation, and to protect work of other trades.

#### **1.07 ENVIRONMENTAL REQUIREMENTS**

- A. All materials shall comply with current Federal and State environmental requirements.

#### **1.08 WARRANTY**

- A. Manufacturer's Material Warranty: Manufacturer's 10 year warranty.
- B. Installer Warranty: Warrant workmanship for a period of two years from the date of Substantial Completion.

### **PART 2 PRODUCTS**

#### **2.01 MANUFACTURERS**

- A. Acceptable Manufacturer: Rainguard Products Company; 3334 E Coast Hwy, #201, Corona del Mar CA 92625. Tel: 949-675-2811; Fax: 949-675-3450; Website: [www.rainguard.com](http://www.rainguard.com), products are specified.
- B. Substitutions: See Section 01 6000 - Product Requirements.

#### **2.02 MATERIALS**

- A. Liquid Water Repellent: Type recommended by manufacturer to suit indicated substrates.
- B. Liquid Water Repellent: Rainguard Products Company "Micro-Seal" with "Micro-Lok."
- C. Anti-Graffiti Coating: "Vandl-Guard", a chemically resistant one part, water-based, cross-linked co-polymer emulsion that dries to a clear, colorless film.

- D. Sacrificial Topcoat: "Vandl-Top", a chemically resistant topcoating compatible with underlying coatings that will not increase flammability of the substrate or support the growth of mildew, bacteria or fungus. Intended for removal with graffiti in event of defacement of substrate and requiring re-application.

### **2.03 ANTI-GRAFFITI COATING SYSTEM**

- A. System requires use of water-repellent coating: Type specified in this Section.
- B. Anti-Graffiti Coating:
  - 1. Clear water repellent, recommended type, one coat only;
  - 2. Anti-Graffiti Coating: "Vandl-Guard"; number of coats recommended by manufacturer to suit indicated substrates.
  - 3. Sacrificial Topcoat: "Vandl-Top", number of coats recommended by manufacturer to suit indicated substrates.

## **PART 3 EXECUTION**

### **3.01 EXAMINATION**

- A. Verify that surfaces to be coated are in proper condition.
  - 1. New substrates: Cured 30 days before application.
  - 2. Cured substrates: Allowed to dry three to seven days following rainfall before application.
  - 3. Substrate moisture content: No higher than 15 percent as registered on an electronic moisture meter.
- B. Do not apply to surfaces below 45 degrees F or above 90 degrees F. Do not apply in the direct sun.
- C. Where freezing conditions have existed before application, allow adequate time for building to thaw.
- D. Do not begin until mock-up/test panels have been approved by Architect.

### **3.02 PREPARATION**

- A. Remove dirt, dust, oil, grease, and other contaminants that would interfere with penetration or performance of products; where cleaners are required, use products recommended by manufacturer; rinse thoroughly and allow to dry completely.
- B. Surfaces shall be structurally sound, dry, clean and free of dust, dirt, grime, oils, scale, rust, silicones, curing compounds, alkali, acid residues, etc.
- C. Prevent overspray, wind drift, and splash onto surfaces not to be treated.
- D. Protect windows and work of other trades against damage by coating, whether to be coated or not.
- E. Protect plant life against damage from coatings.

### **3.03 APPLICATION**

- A. Apply materials in strict accordance with manufacturer's recommendations and when substrate surface temperature is above 45 degrees F. (7 degrees C).
  - 1. Follow instructions in manufacturer's current technical data sheet for general information and coverage rates.

- B. Mix materials in strict accordance with manufacturer's instructions; do not dilute unless permitted by manufacturer.
- C. Spray apply water repellent using high-volume, low-pressure spray equipment. Pressure not to exceed 60 psi (412 kPa). Hudson or garden-type sprayer can be used for small applications.
- D. Clean all drips, runs, and overspray residue while still wet.
- E. Allow coating(s) to dry and become clear before applying subsequent coats. Achieve a uniform pinhole free, continuous film.
- F. During process of work, remove discarded coating materials, rubbish, cans, and rags at end of each workday.

**3.04 FIELD QUALITY CONTROL**

- A. Provide the services of the manufacturer's authorized field representative to verify that installed products comply with manufacturer's requirements and with the standard established by the Architect -approved mock-up/test panels.

**3.05 ADJUSTING, CLEANING AND PROTECTION**

- A. At completion of work, remove protective coverings.
- B. If surfaces that should have been protected from damage by this work have been damaged, clean, repair or replace to the satisfaction of the Architect.
- C. Repair or replace damaged treated surfaces.
- D. Protect completed work from damage during construction.

**3.06 SCHEDULE**

- A. Substrates to receive anti-graffiti coating: Section 09 2513 - Acrylic-Modified Portland Cement Plaster.

**END OF SECTION**

## SECTION 10 0610

### EXTERIOR SIGNAGE

#### PART 1 - GENERAL

##### 1.1 RELATED DOCUMENTS

- A. Drawings and general provisions of the Contract, including General and Supplementary Conditions and Division 1 Specification Sections, apply to this Section.

##### 1.2 SUMMARY

- A. Work Included: Installation of exterior traffic signage and related work as shown on the drawings and/or specified herein.
- B. Related Sections include:
  - 1. Section 10 1400 "Signage" for interior signage and exterior building signage
- C. References:
  - 1. State of California Maintenance Manual, latest editions.
  - 2. State of California Traffic Manual, latest edition.
  - 3. Regulations, standards, and tests of the State of California Materials and Research Division.
  - 4. State of California Standard Plans and Specifications.
  - 5. Americans with Disabilities Act.
  - 6. California Building Code, 2019 Edition.

##### 1.3 SUBMITTALS

- A. Product Data: Submit manufacturer's product data describing materials and signs.
- B. Shop Drawings: Shop drawings with letter style and general layout for each sign type, with sizes, edge and corner treatment, and mounting methods shown.
- C. Selection Samples: For each finish specified, two complete sets of color chips representing manufacturer's full range of available colors, patterns and finishes.
- D. Verification Samples: For each finish product specified, one full-size sign representing actual product, color, patterns, and finishes. Include method if raised symbols and copy.

##### 1.4 DELIVERY, STORAGE, AND HANDLING

- A. Comply with manufacturer's recommendations for delivery, storage and handling.
- B. Materials shall be delivered to the location in unopened, labeled factory containers. Upon delivery, materials shall be inspected for damage. Deficient materials shall not be used.

**1.5 PROJECT CONDITIONS**

- A. Maintain environmental conditions (temperature, humidity, and ventilation) within limits recommended by manufacturer for optimum results. Do not install products under environmental conditions outside manufacturer's absolute limits.

**1.6 PERFORMANCE REQUIREMENTS**

- A. All work shall be done to the satisfaction of the Owner or Owner's representative.
- B. Manufacturer's certificates showing conformance with this specification shall be delivered to Owner with each shipment of materials and equipment delivered to the job site.

**PART 2 - PRODUCTS**

**2.1 MANUFACTURERS**

- A. Acceptable Manufacturers: As selected by the Architect.

**2.2 MATERIALS**

- A. Traffic control sign panels shall be of the type, size, shape, and pattern designated or called for on the plans and detail drawings. Sign faces shall be of reflectorized porcelain enamel unless otherwise specified on the plans or detail drawings.
- B. Posts for traffic control signs, unless designated to be mounted on traffic signal or electrolier standards, shall be two (2) inch I.D. steel pipe conforming to the requirements of Section 56-2.02A of the State Standard Specifications.
- C. Mounting hardware for traffic control signs shall conform to the applicable requirements and specifications contained in the State of California Department of Transportation "Standard Plans" publication, latest edition.
- D. Concrete bases for traffic control sign posts shall be Class "B" Portland cement concrete of the shape and dimensions shown or called for on the plans and detail drawings. Replace Portland cement in concrete with at least 30% of flyash or slag.

**PART 3 - EXECUTION**

- 3.1 Traffic control signs shall be installed in conformance with the applicable requirements of the State of California Maintenance Manual.
- 3.2 After installation, damage to traffic sign faces shall be touched up as required to the satisfaction of the Engineer.

**END OF SECTION 10 0610**

**SECTION 10 1100  
VISUAL DISPLAY UNITS**

**PART 1 GENERAL**

**1.01 SECTION INCLUDES**

- A. Markerboards and Tackboards.
  - 1. Fixed Type.
  - 2. Accessories.

**1.02 RELATED REQUIREMENTS**

- A. Section 01 6116 - Volatile Organic Compound (VOC) Content Restrictions.
- B. Section 01 8113 - Sustainable Design Requirements.
- C. Section 06 1000 - Rough Carpentry: Blocking and supports.
- D. Section 06 4100 - Architectural Woodwork: Reference standards for installation of sliding visual display boards into custom cabinets.

**1.03 REFERENCE STANDARDS**

- A. ANSI A135.4 - American National Standard for Basic Hardboard; 2012.
- B. ANSI A208.1 - American National Standard for Particleboard; 2009.
- C. ASTM A424/ A424M - Standard Specification for Steel, Sheet, for Porcelain Enameling; 2009a.
- D. ASTM E84 - Standard Test Method for Surface Burning Characteristics of Building Materials; 2015a.
- E. ASTM F793 - Standard Classification of Wall Covering by Use Characteristics; 2010a.
- F. California Code of Regulations, Title 24, Part 2, California Building Code (CBC), International Building Code.
- G. California Code of Regulations, Title 24, Part 11, California Green Building Standards Code, "CAL-Green".
- H. GREENGUARD Environmental Institute: GREENGUARD Indoor Air Quality Certified.
- I. Porcelain Enamel Institute: PEI-1002 Manual and Performance Specifications for Porcelain Enamel Writing Surfaces.

**1.04 SUBMITTALS**

- A. See Section 01 3300 - Submittals, for submittal procedures.
- B. Product Data: Provide manufacturer's data on chalkboard, markerboard, tackboard, tackboard surface covering, trim, and accessories.
- C. CAL-GREEN Submittals:
  - 1. Product Data - VOC Limits: For adhesives, sealants, fillers, primers and coatings, documentation including printed statement of VOC contents, comply with limits specified in related section.
  - 2. Composite Wood Formaldehyde Limits: Provide certification that all products meet current CARB Airborne Toxic Control Measure (ATCM) for Composite Wood Formaldehyde Limits by Mandatory Compliance Dates as specified in related section.

- D. Shop Drawings: Indicate wall elevations, dimensions, joint locations, special anchor details.
- E. Samples: Submit color charts for selection of color and texture of markerboard, tackboard, tackboard surface covering, and trim.
- F. Test Reports: Show compliance to specified surface burning characteristics requirements.
- G. Manufacturer's printed installation instructions.
- H. Maintenance Data: Include data on regular cleaning, stain removal, and maintenance precautions.

#### **1.05 QUALITY ASSURANCE**

- A. Manufacturer Qualifications: Company specializing in manufacturing the products specified in this section with minimum three years documented experience.

#### **1.06 FIELD CONDITIONS**

- A. Field measure prior to preparation of shop drawings and fabrication, to ensure proper fit.
- B. Do not begin installation of visual display boards until environmental conditions approximate normal occupied conditions.

#### **1.07 WARRANTY**

- A. See Section 01 7000 - Closeout Submittals, for additional warranty requirements.
- B. Submit manufacturer's "Life of the Building" warranty, stating that under normal usage and maintenance, and when installed in accordance with manufacturer's instructions and recommendations, porcelain enamel steel chalkboards and markerboards are guaranteed for the life of the building.
  - 1. Warranty shall cover replacement of defective boards but not the cost of removal or reinstallation.

### **PART 2 PRODUCTS**

#### **2.01 PERFORMANCE REQUIREMENTS**

- A. VOC Limits for adhesives, sealants, fillers, primers and coatings . Comply with limits specified in related section.
- B. Composite Wood products must meet current CARB Airborne Toxic Control Measure (ATCM) for Composite Wood Formaldehyde Limits by Mandatory Compliance Dates as specified in Section 01 6116.

#### **2.02 MANUFACTURERS**

- A. Visual Display Boards:
  - 1. AARCO Products, Inc.; web: [www.aarcoproducts.com](http://www.aarcoproducts.com) .
  - 2. Platinum Visual Systems as distributed by ABC School Equipment. [www.pvsusa.com](http://www.pvsusa.com)

#### **2.03 VISUAL DISPLAY UNITS**

- A. Markerboards: Porcelain enamel on steel, laminated to core.
  - 1. Steel Face Sheet Thickness: 24 gage, 0.0239 inch (0.61 mm).
  - 2. Core: Particleboard, manufacturer's standard thickness, laminated to face sheet.
  - 3. Backing: Aluminum foil, laminated to core.
  - 4. Size: As indicated on drawings. If no size is shown, provide 48 inches by 96 inches.
  - 5. Frame: Extruded aluminum, with concealed fasteners.



6. Frame Finish: Anodized, natural.
  7. Accessories: Provide chalk tray, map rail, and flag holder. (Two flag holders per room).
- B. Tackboards: Fine-grained, homogeneous natural cork.
1. Cork Thickness: 1/8 inch (3 mm).
  2. Surface Burning Characteristics: Flame spread index of 25, maximum, and smoke developed index of 450, maximum, when tested in accordance with ASTM E84.
  3. Size: As indicated on drawings, except if no size is given, provide 48 inches by 72 inches.
  4. Frame: Same type and finish as for chalkboard.
  5. Accessories: Provide map rail.

#### **2.04 FABRICATION**

- A. Laminate facing sheet and backing sheet to core material under pressure, using manufacturer's recommended adhesive.
- B. Provide factory-assembled visual display boards, except where sizes demand partial field assembly.
  1. Free of cups and bows, facing sheet and core continuous with no joints for entire length of board.
- C. Assemble units in one piece without joints, wherever possible. Where required dimensions exceed maximum panel size available, provide 2 or more pieces of equal length, as indicated on approved shop drawings. Assemble to verify fit at factory, then disassemble for delivery and final assembly at project site.
- D. Miter corners to neat hairline closure.
- E. Combination Units and Units Made of More Than One Panel: Factory-assembled chalkboards, markerboards, and tackboards in a single frame, of materials specified above.
  1. Join panels of different construction with H-shaped extruded aluminum molding finished to match frame.
  2. Join panels of similar construction with butt joints, aligned and secured with steel spline concealed in edge of core.
  3. Configuration: As indicated on drawings.

#### **2.05 MATERIALS**

- A. Porcelain Enameled Steel Sheet: ASTM A424/A424M, Type I, Commercial Steel, with fired-on vitreous finish.
- B. Vinyl Coated Fabric: ASTM F793 Category VI.
- C. Hardboard for Cores: ANSI A135.4, Class 1 - Tempered, S2S (smooth two sides).
- D. Particleboard: ANSI A208.1; wood chips, set with waterproof resin binder, sanded faces.
- E. Foil Backing: Aluminum foil sheet, 0.005 inch (0.13 mm) thick.
- F. Adhesives: Type used by manufacturer.

#### **2.06 ACCESSORIES**

- A. Map Rail: Extruded aluminum, manufacturer's standard profile, with cork insert and runners for accessories; 1 inch (25 mm) wide overall, full width of frame.
- B. Temporary Protective Cover: Sheet polyethylene, 8 mil (0.2 mm) thick.

- C. Flag Holders: Cast aluminum bored to receive 1 inch (25 mm) diameter flag staff, bracketed to fit top rail of board.
- D. Cleaning Instruction Plate: Provide instructions for chalkboard cleaning on a metal plate fastened to perimeter frame near chalkrail.
- E. Chalk Tray: Aluminum, manufacturer's standard profile, one piece full length of chalkboard, open ends, concealed fasteners, same finish as frame.
- F. Mounting Brackets: Concealed.

### **PART 3 EXECUTION**

#### **3.01 EXAMINATION**

- A. Verify that field measurements are as indicated.
- B. Verify that internal wall blocking is ready to receive work and positioning dimensions are as indicated on shop drawings.

#### **3.02 INSTALLATION**

- A. Install boards in accordance with manufacturer's instructions.
- B. Install all grounds, clips, backing materials, adhesives, brackets, anchors, trim, and accessories necessary for a complete installation.
- C. Secure units level and plumb. Align perimeter trim for visual continuity and in accordance with manufacturer's recommendations.
- D. Butt Joints: Install with tight hairline joints.
- E. Where sliding visual display boards are installed in custom cabinets, provide track stops as recommended by board manufacturer to prevent sliding boards from impacting cabinet frames and comply with Referenced Standards for cabinet work.

#### **3.03 CLEANING**

- A. Verify that all accessories are installed as required for each unit.
- B. Clean board surfaces in accordance with manufacturer's instructions.
- C. Cover with protective cover, taped to frame.
- D. Remove temporary protective cover at Date of Substantial Completion.
- E. Protect completed work from damage until acceptance. Replace damaged work.

**END OF SECTION**

## SECTION 10 1400

### SIGNAGE

#### PART 1 GENERAL

##### 1.01 SECTION INCLUDES

- A. Room and door signs with raised tactile letters and braille.
- B. Interior directional and informational signs with raised tactile letters and braille.
- C. Vinyl Graphics.

##### 1.02 RELATED REQUIREMENTS

- A. Division 08: Pertinent sections specifying doors and glazing materials serving as the mounting surface for signage.
- B. Division 09: Pertinent sections specifying wall finishes and substrates serving as the mounting surface for signage.

##### 1.03 REFERENCE STANDARDS

- A. 36 CFR 1191 - Americans with Disabilities Act (ADA) Accessibility Guidelines for Buildings and Facilities; Architectural Barriers Act (ABA) Accessibility Guidelines; current edition.
- B. ADA Standards - Americans with Disabilities Act (ADA) Standards for Accessible Design; 2010.
- C. California Code of Regulations, Title 24, Part 2, California Building Code (CBC), International Building Code.
- D. Standards for jurisdiction where project is located.

##### 1.04 SUBMITTALS

- A. See Section 01 3300 - Submittals for submittal procedures.
- B. Product Data: Manufacturer's printed product literature for each type of sign, indicating sign styles, font, foreground and background colors, locations, overall dimensions of each sign.
- C. Signage Schedule: Provide information sufficient to completely define each sign for fabrication, including room number, room name, other text to be applied, sign and letter sizes, fonts, and colors.
  - 1. When room numbers to appear on signs differ from those on drawings, include the drawing room number on schedule.
  - 2. When content of signs is indicated to be determined later, request such information from Owner through Architect at least 2 months prior to start of fabrication; upon request, submit preliminary schedule.
  - 3. Submit for approval by Owner through Architect prior to fabrication.
- D. Shop Drawings: Indicate sign styles, lettering font, foreground and background colors, locations, overall dimensions of each sign.
  - 1. Submit shop drawing at scaled size for each typical sign. Indicate: Proposed copy, letter height, spacing and location of lettering on the sign field, colors and materials of each element and lettering. Tabular listing of signage and copy alone is not acceptable.
  - 2. Submit tabular listing for each sign keyed to location indicated on drawings, including all text and adjacent space for Owner modification/confirmation of text.
  - 3. Provide all drawings and detail documents necessary to complete the project.

4. Where sizes for signs are impacted by dimensions of surfaces or locations on which they are to be installed, verify dimensions by field measurement. Indicate measurements and signage locations on shop drawings for approval prior to production.
  5. Indicate for monument sign: Member and material profiles, sizes, connection attachments, reinforcing, anchorage, size and type of fasteners, and accessories. Include erection drawings, elevations, and details
- E. Samples: Submit two samples of each type of sign, of size similar to that required for project, illustrating sign style, font, and method of attachment.
- F. Selection Samples: Where colors are not specified, submit two sets of color selection charts or chips.
- G. Manufacturer's Installation Instructions: Include installation templates and attachment devices.

### **1.05 QUALITY ASSURANCE**

- A. Manufacturer Qualifications: Company specializing in manufacturing the products specified in this section with minimum Five years of documented experience.

### **1.06 DELIVERY, STORAGE, AND HANDLING**

- A. Package signs as required to prevent damage before installation.
- B. Package room and door signs in sequential order of installation, labeled by floor or building.

## **PART 2 PRODUCTS**

### **2.01 REGULATORY REQUIREMENTS**

- A. Conform to applicable code for requirements..
1. C.C.R., Title 24, Part 2. California Building Code, Sections 1009.8, 1009.9, 1023.8, 1023.9, 1023.10 and 11B-703 for requirements governing signage design, location and attributes.
  2. Braille Symbols: California Contracted Grade 2 Braille symbols shall be used per CBC 11B-703.3. Provide only domed Contracted Grade 2 Braille symbols with dimensions in accordance with Table 11B-703.3.1.
- B. It is the sole responsibility of the signage contractor to obtain all permits required for signage contained in this project. Signage contractor to obtain, provide, produce and process all documentation, and pay all fees required for the permitting process.
- C. Signs shall be field-inspected per CBC 11B-703.1.1.2.

### **2.02 MANUFACTURERS**

- A. Plaque Signs:
1. Advance Corporation / Braille-Tac Division; Product Braille-Tac Etched Magnesium (Chemsast): 8200 - 97th Street South, Cottage Grove, Minnesota 55016: Telephone 800-328-9451; [www.advancecorp.com/brailletac](http://www.advancecorp.com/brailletac)
  2. Substitutions: See Section 01 6000 - Product Requirements.
- B. Vinyl Graphics:
1. 3M / Commercial Products Division; Product 3M Premium Grade Vinyl: 3M Center, Building 220-6W-06, Post Office Box 33220, St. Paul, Minnesota 55133-3220: Telephone 800-374-6772.
  2. Substitutions: See Section 01 6000 - Product Requirements.

### 2.03 SIGNAGE APPLICATIONS

- A. Accessibility Compliance: Signs are required to comply with ADA Standards and applicable building codes, unless otherwise indicated; in the event of conflicting requirements, comply with the most comprehensive and specific requirements.
- B. Room and Door Signs: Provide a sign for every doorway, whether it has a door or not, not including corridors, lobbies, and similar open areas.
  - 1. Sign Type: Flat signs with engraved panel media as specified.
  - 2. Provide "tactile" signage, with letters raised minimum 1/32 inch (0.8 mm) and Grade II braille.
  - 3. Character Height: 1 inch (25 mm).
  - 4. Sign Height: 3 inches (75 mm), unless otherwise indicated.
  - 5. Service Rooms: Identify with room names and numbers to be determined later, not those indicated on drawings.
  - 6. Rest Rooms: Identify with pictograms, the names "MEN" and "WOMEN", room numbers to be determined later, and braille, provide separate Facility Identification Symbols on doors as shown on Drawings.
  - 7. Tactile Exit and Exit Route Signs: Raised letters and Braille as specified for Room and Door signs.
  - 8. Exit Stair and Exit Ramp Signs: Raised letters and Braille as specified for Room and Door signs.
- C. Interior Directional and Informational Signs:
  - 1. Sign Type: Same as room and door signs.
  - 2. Lift Signage: Pictograms and copy shown on Drawings.
  - 3. Room Occupancy Signage: All rooms with Occupant Load greater than 50. Verify actual numbers with Architect.
  - 4. Tactile Exit and Exit Route Signs: Raised letters and Braille as specified for Room and Door signs.
  - 5. Assistive Listening Sign: Pictogram and copy shown on Drawings.
  - 6. Other sign types indicated on the Drawings.
  - 7. Wording of signs is scheduled on drawings.

### 2.04 PLAQUE SIGNS

- A. Plaque Signs: One piece magnesium metal construction with raised character copy and braille with thermal-set, polyurethane finish. Tactile legends and Braille shall comply with Americans with Disabilities Act (ADA), California Building Code (CBC) and requirements indicated for quantities, sizes, layouts, materials, finishes, color, etc. as specified in the Graphics Schedule and Drawings/Specifications.
  - 1. Exterior durability rating: 3 years minimum.
  - 2. Painted Finish:
    - a. Weatherability: When tested in accordance with ASTM G 53, after 500 hours in a Weatherometer (equivalent to 3 years of exterior exposure) gloss retention of not less than 88.0 determined in accordance with ASTM D 523 as a 60 degree angle.
    - b. Color Fade Resistance: Color shall not change more than 1.68 units determined in accordance with ASTM D 2244 and measured with a Hunter colorimeter, Model D25.
    - c. Durability: Sign finish shall show no effect after requested use of cleaners such as Graffiti Remover #1120 manufactured by Fine Organics Corp., Lodi, NJ.
    - d. Non-Glare Finish
  - 3. Colors: Custom, as selected by Architect.

4. Total Thickness: 0.153 inches.
5. Sign Edges: Square. Sign edges at geometric symbols shall be eased or chamfered in accordance with governing code.

B. Raised Characters:

1. Comply with applicable provisions of ANSI/ICC A117.1, including Braille.
2. Character Color: As selected by Architect..
3. Character Font: As Indicated.
4. Character Stroke Width: As required by referenced codes, 1/8 inch (3 mm).
5. Character Height: As indicated. If not shown, provide 1 inch (25 mm).
6. Character Edges: Square.
7. Character Case: Upper case only.

## 2.05 VINYL GRAPHICS

- A. Adhesive Vinyl Graphics of ISA for installation on glass or similar substrates.
- B. Base Material: Premium Grade with an outdoor durability rating of five years.
  1. Color: Provide as shown on Drawings. If no colors are indicated, provide International Blue with white pictograms..

## 2.06 ACCESSORIES

- A. Concealed Screws: Stainless steel, galvanized steel, chrome plated, or other non-corroding metal.
- B. Exposed Screws: Stainless steel.
- C. Mounting Hardware: Vandal-proof screws, stainless steel, size recommended by manufacturer to suit applications and resist applied loads.
- D. Adhesive: 3M Corporation, "VHB", applied in 5 mil thickness covering entire back of sign plaque without void or bubble.
- E. Silicon Adhesive: Silglaze II #2801 GE Clear - Silicone Sealant / Adhesive.
- F. Accessories and materials required for complete installation as indicated.

## PART 3 EXECUTION

### 3.01 COORDINATION

- A. For signs supported by or anchored to permanent construction such as building such as building fascias, advise installers about specific requirements for placement of anchorage devices and similar items to be used for attaching signs.

### 3.02 EXAMINATION

- A. Confirm visibility of site signage and graphics in indicated locations. Do not install signs in locations where they will not be visible or where they will obstruct visibility of other related building elements, such as exit signage or life safety equipment provided under other contracts or sections. Request direction from Architect in the event of conflict with signage and building elements.
- B. Verify that substrate surfaces are ready to receive work.
- C. Clean substrates to receive adhered vinyl graphics or tape adhesive using means recommended by adhesive manufacturer that will not damage substrates. Remove contamination and materials that might impede film adhesion.

### **3.03 INSTALLATION**

- A. Install in accordance with manufacturer's instructions.
- B. Install signs after surfaces are finished, in locations indicated.
- C. Install neatly, with horizontal edges level.
- D. Locate signs and mount at heights indicated on drawings and in accordance with ADA Standards and ICC A117.1.
- E. Install signage and graphics plumb, level and proportionally spaced or kerned as required for uniform appearance; centered on, or aligned with related building elements, measured from established lines and levels, accurately fitted, free from distortion or defects.
- F. Fastening to In-Place Construction: Provide anchorage devices and fasteners where necessary for securing items to in-place construction; including threaded fasteners for concrete inserts, toggle bolts, through-bolts, lag bolts, wood screws, and other connectors as required.
- G. Install vinyl graphics on clean substrates in accordance with vinyl manufacturer instructions, flat, smooth, free of defects, bubbles dust, blemishes and air pockets.
- H. Plaque Mounting on Glazing: Install on glazing with double stick tape and silicone adhesive. Provide self-adhesive opaque plastic film, in matching or contrasting color as selected, to conceal reverse side of signs mounted on glazing. No exposed fasteners, adhesives or glazing tapes permitted. Film backer must be computer cut to match the shape of the plaque(s).
- I. Plaque Mounting at all other interior locations: Provide double stick tape and silicone.
- J. Plaque Mounting at all other exterior locations: Provide double stick tape and anchorage devices and fasteners as necessary for securing items to in-place construction; including threaded fasteners for concrete inserts, toggle bolts, through-bolts, lag bolts, wood screws, wedge anchors and other connectors as required.

### **3.04 ADJUSTING**

- A. Correct all damaged work by cleaning, repairing or replacing, and repainting, as acceptable to Architect.
- B. Protect from damage until Substantial Completion; repair or replace damaged items.

### **3.05 SCHEDULES**

- A. Refer to Graphics Plans, Schedules and Details on the Drawings.

**END OF SECTION**

**SECTION 10 2800**  
**TOILET ACCESSORIES**

**PART 1 GENERAL**

**1.01 SECTION INCLUDES**

- A. Commercial toilet accessories.
- B. Utility room accessories.
- C. Installation of Owner furnished accessories.

**1.02 RELATED REQUIREMENTS**

- A. Pertinent sections specifying concealed supports and blocking for accessories, including in wall framing and plates, above ceiling framing, and locations required.
- B. Section 10 2113 - Reinforced Composite Toilet Compartments
- C. Divisions 22 and 26: Pertinent sections specifying plumbing and electrical work.

**1.03 REFERENCE STANDARDS**

- A. ADA Standards - Americans with Disabilities Act (ADA) Standards for Accessible Design; 2010.
- B. C.C.R., Title 24, Part 2, California Building Code for accessibility standards.
- C. Manufacturer's recommendations and specifications.
- D. ASTM A123/A123M - Standard Specification for Zinc (Hot-Dip Galvanized) Coatings on Iron and Steel Products; 2015.
- E. ASTM A666 - Standard Specification for Annealed or Cold-Worked Austenitic Stainless Steel Sheet, Strip, Plate, and Flat Bar; 2015.
- F. ASTM B456 - Standard Specification for Electrodeposited Coatings of Copper Plus Nickel Plus Chromium and Nickel Plus Chromium; 2011.
- G. ASTM C1036 - Standard Specification for Flat Glass; 2011.
- H. ASTM C1503 - Standard Specification for Silvered Flat Glass Mirror; 2008 (Reapproved 2013).

**1.04 SUBMITTALS**

- A. See Section 01 3300 - Submittals, for submittal procedures.
- B. Product Data: Submit data on accessories describing size, finish, details of function, and attachment methods.
- C. Manufacturer's Installation Instructions: Indicate special procedures and conditions requiring special attention.

**1.05 COORDINATION**

- A. Coordinate the work with the placement of internal wall reinforcement, concealed ceiling supports, and reinforcement of toilet partitions to receive anchor attachments.



## **PART 2 PRODUCTS**

### **2.01 MANUFACTURERS**

- A. Commercial Toilet, Shower, and Bath Accessories:
  - 1. Bobrick Washroom Equipment, Inc.
  - 2. American Specialties, Inc: [www.americanspecialties.com](http://www.americanspecialties.com).
  - 3. Bradley Corporation: [www.bradleycorp.com/#sle](http://www.bradleycorp.com/#sle).
  - 4. Tubular Specialties Manufacturing, "TSM".
- B. Provide products of each category type by single manufacturer.

### **2.02 MATERIALS**

- A. Accessories - General: Shop assembled, free of dents and scratches and packaged complete with anchors and fittings, steel anchor plates, adapters, and anchor components for installation.
  - 1. Grind welded joints smooth.
  - 2. Fabricate units made of metal sheet of seamless sheets, with flat surfaces.
- B. Keys: Provide two keys for each accessory to Owner; master key lockable accessories.
- C. Mirror Glass: Annealed float glass, ASTM C1036 Type I, Class 1, Quality Q2, with silvering, protective and physical characteristics complying with ASTM C1503.
- D. Adhesive: Two component epoxy type, waterproof.
- E. Fasteners, Screws, and Bolts: Hot dip galvanized; tamper-proof; security type.

### **2.03 FINISHES**

- A. Stainless Steel: Satin finish, unless otherwise noted.
- B. Back paint components where contact is made with building finishes to prevent electrolysis.

### **2.04 Commercial Toilet Accessories**

- A. Mirrors: Stainless steel framed, 1/4 inch (6 mm) thick annealed float glass; ASTM C1036.
  - 1. Size: as indicated.
  - 2. Frame: 0.05 inch (1.3 mm) angle shapes, with mitered and welded and ground corners, and tamperproof hanging system; satin finish.
  - 3. Product: B-2908 manufactured by Bobrick.
- B. Seat Cover Dispenser: Stainless steel, surface-mounted, reloading by concealed opening at base, tumbler lock.
  - 1. Minimum capacity: 250 seat covers.
- C. Grab Bars: Stainless steel, \_\_\_ inches (1-1/4 min. to 2 max. mm) outside diameter, minimum 0.05 inch (1.3 mm) wall thickness, concealed flange mounting; 1-1/2 inches (38 mm) clearance between wall and inside of grab bar.
  - 1. Conform to CBC accessibility requirements and referenced standards, support vertical loading of 400 pounds and horizontal loading of 200 pounds applied at any portion of the bar.
  - 2. Length and configuration: As indicated on drawings.
  - 3. Product: B5806 manufactured by Bobrick.
- D. Sanitary Napkin Disposal Unit: Stainless steel, surface-mounted, self-closing door, locking bottom panel with full-length stainless steel piano-type hinge, removable receptacle.
  - 1. Product: B-353 manufactured by Bobrick, recessed mounted.

- E. Sanitary Napkin Disposal Unit: Stainless steel, semi-recessed, self-closing door, locking bottom panel with full-length stainless steel piano-type hinge, removable receptacle.
  - 1. Product: B-353, manufactured by Bobrick.
  - 2. Product: 4722-10-15 manufactured by Bradley.
- F. Coat Hooks: Doors of single occupancy toilet rooms. Stainless steel, bright polished finish, Bobrick B-682, 6-1/4 inch high, projection 3 inches.
  - 1. Mount coat hooks at 48" above finish floor in single occupancy toilet rooms and accessible stalls.

## **2.05 UTILITY ROOM ACCESSORIES**

- A. Mop Sink Cabinet: Double-door stainless steel cabinet for mop sink and accessories.
  - 1. Double Width Cabinet 300 stainless steel, handing as indicated on Drawings.
  - 2. 16" x 20" x 12" Sink Bowl - (drain included).
  - 3. Opening for mop bucket to roll in.
  - 4. Ventilation Slots.
  - 5. Hinged Double Doors.
  - 6. 4 Fixed Intermediate Shelves (3 in storage side, 1 above sink)
  - 7. 2 Mop Holders (1 on either side - above mop sink)
  - 8. Fabrication:
    - a. 16 gauge type "304" Series Sink Bowl
    - b. 18 gauge type "304" Series Sink Bowl Apron
    - c. All TIG welded.
    - d. Welded areas blended to match adjacent surfaces and to a satin finish.
  - 9. Include the following:
    - a. SU-27 Door Lock
    - b. K-94-SHELF Fixed Mid-shelf for 84" High Cabinets
    - c. Stainless Steel Back Panel
    - d. K-472 Add 8" O.C. Faucet Holes for Service Faucet
    - e. K-240 Service Faucet
  - 10. Product: Advance Tabco 9-OPC-84D(L or R)-300; [www.advancetabco.com](http://www.advancetabco.com).
  - 11. Substitutions: Section 01 6000 - Product Requirements.

## **PART 3 EXECUTION**

### **3.01 EXAMINATION**

- A. Verify existing conditions before starting work.
- B. Verify exact location of accessories for installation. Conform to referenced standards and applicable codes.
- C. Verify that field measurements are as indicated on drawings.

### **3.02 PREPARATION**

- A. Provide templates and rough-in measurements as required.

### **3.03 INSTALLATION**

- A. Install accessories in accordance with manufacturers' instructions in locations indicated on drawings.
- B. Install plumb and level, securely and rigidly anchored to substrate.

- C. Mounting Heights and Locations: As required by accessibility regulations and as indicated on drawings

**END OF SECTION**

**SECTION 10 4400**  
**FIRE PROTECTION SPECIALTIES**

**PART 1 GENERAL**

**1.01 SECTION INCLUDES**

- A. Fire extinguishers.
- B. Fire extinguisher cabinets.
- C. Accessories.

**1.02 RELATED REQUIREMENTS**

- A. Section 01 6116 - Volatile Organic Compound (VOC) Content Restrictions.
- B. Section 01 8113 - Sustainable Design Requirements.
- C. Pertinent section specifying wood or metal blocking for attachment of products.
- D. Pertinent sections specifying firestopping and acoustic barriers.
- E. Section 09 9123 - Interior Painting: Field paint finish.

**1.03 REFERENCE STANDARDS**

- A. ASTM E814 - Standard Test Method for Fire Tests of Through-Penetration Fire Stops; 2013a.
- B. FM (AG) - FM Approval Guide; current edition.
- C. NFPA 10 - Standard for Portable Fire Extinguishers; 2013.
- D. UL (DIR) - Online Certifications Directory; current listings at database.ul.com.
- E. 36 CFR 1191 - Americans with Disabilities Act Accessibility Guidelines for Buildings and Facilities; Final Rule; Federal Register, July 26, 1991; updated 2010.
- F. 28 CFR 35.151 Standards for State and Local Government Facilities: Title II.
- G. California Code of Regulations, Title 24, Part 2, California Building Code (CBC), International Building Code.
- H. California Code of Regulations, Title 24, Part 11, California Green Building Standards Code, "CAL-Green".

**1.04 SUBMITTALS**

- A. See Section 01 3300 - Submittals, for submittal procedures
- B. Provide complete submittals at the same time as submittals for work in related sections to permit review of complete and integrated systems and assemblies.
- C. CAL-GREEN Submittals: Product Data - VOC Limits: For adhesives sealants, fillers, primers and coatings, documentation including printed statement of VOC contents, comply with limits specified in related section.
- D. Shop Drawings: Indicate cabinet physical dimensions. mounting heights and locations.
- E. Manufacturer's Installation Instructions: Indicate special criteria and wall opening coordination requirements.

- F. Maintenance Data: Include test, refill or recharge schedules and re-certification requirements.

## 1.05 FIELD CONDITIONS

- A. Do not install extinguishers when ambient temperature may cause freezing of extinguisher ingredients.

## PART 2 PRODUCTS

### 2.01 PERFORMANCE REQUIREMENTS

- A. VOC Limits for adhesives, sealants, fillers, primers and coatings . Comply with limits specified in related section.

### 2.02 MANUFACTURERS

- A. Fire Extinguishers:
  1. Larsen's Manufacturing Company, Minneapolis, MN, [www.larsensmfg.com](http://www.larsensmfg.com), is specified.
  2. Ansul, a Tyco Business; Cleanguard: [www.ansul.com/#sle](http://www.ansul.com/#sle).
  3. J. L. Industries, Inc.; a division of Activar Construction Products Group.
  4. Nystrom, Inc: [www.nystrom.com/#sle](http://www.nystrom.com/#sle).
  5. Potter-Roemer Inc., Cerritos, CA, [www.potterroemer.com](http://www.potterroemer.com).
  6. Pyro-Chem, a Tyco Business: [www.pyrochem.com/#sle](http://www.pyrochem.com/#sle).
  7. Substitutions: See Section 01 6000 - Product Requirements.
- B. Fire Extinguisher Cabinets and Accessories:
  1. Ansul, a Tyco Business: [www.ansul.com/#sle](http://www.ansul.com/#sle).
  2. Larsen's Manufacturing Co: [www.larsensmfg.com/#sle](http://www.larsensmfg.com/#sle).
  3. Nystrom, Inc: [www.nystrom.com/#sle](http://www.nystrom.com/#sle).
  4. Potter-Roemer: [www.potterroemer.com/#sle](http://www.potterroemer.com/#sle).
  5. Pyro-Chem, a Tyco Business: [www.pyrochem.com/#sle](http://www.pyrochem.com/#sle).
  6. Substitutions: See Section 01 6000 - Product Requirements.

### 2.03 FIRE EXTINGUISHERS

- A. Fire Extinguishers - General: Comply with product requirements of NFPA 10 and applicable codes, whichever is more stringent.
  1. Provide extinguishers labeled by UL (DIR) or FM (AG) for purpose specified and as indicated.
  2. Attach manufacturer's standard metal foil label to cylinder, with printing and graphics indicating information and instructions required by local authorities having jurisdiction. Include current certification tag
- B. Multipurpose Dry Chemical Type Fire Extinguishers: Carbon steel tank, with pressure gauge.
  1. Class: A:B:C type.
  2. Size and classification as scheduled.
  3. Finish: Baked polyester powder coat, red color.
- C. Dry Chemical Type Fire Extinguishers: Stainless steel tank, with pressure gauge.
  1. Class: K type.
  2. Size and classification as scheduled.
  3. Finish: Polished stainless steel.
  4. Temperature range: Minus 20 degrees F (Minus 29 degrees C) to 120 degrees F (49 degrees C).

## **2.04 FIRE EXTINGUISHER CABINETS**

- A. Fire Rating: Listed and labeled in accordance with ASTM E814 requirements for fire resistance rating of walls where being installed.
- B. Fire Rated Cabinet Construction: One-hour fire rated.
  - 1. Steel; double wall or outer and inner boxes with 5/8 inch (15.9 mm) thick fire barrier material.
- C. Cabinet Configuration: Recessed type. Larsen "Cameo" or equal.
  - 1. Size to accommodate accessories.
  - 2. Trimless type.
- D. Cabinet Configuration: Semi-recessed type. Larsen "Cameo" or equal.
  - 1. Size to accommodate accessories.
  - 2. Projected Trim: Returned to wall surface, with 2-1/2 inch (\_\_\_\_ mm) projection, and 2-1/2 inch (\_\_\_\_ mm) wide face with rolled edge.
  - 3. Provide cabinet enclosure with right angle inside corners and seams, and with formed perimeter trim and door stiles.
- E. Door: 0.036 inch (0.9 mm) metal thickness, reinforced for flatness and rigidity with nylon catch. Hinge doors for 180 degree opening with two butt hinge.
- F. Door Glazing: Acrylic plastic, clear, 1/8 inch (3 mm) thick, full view bubble shape and set in resilient channel glazing gasket.
- G. Cabinet Mounting Hardware: Appropriate to cabinet, with pre-drilled holes for placement of anchors.
- H. Weld, fill, and grind components smooth.
- I. Finish of Cabinet Exterior Trim and Door: No. 4 - Brushed stainless steel.
- J. Finish of Cabinet Interior: White colored enamel.

## **2.05 ACCESSORIES**

- A. Wall mounting bracket: Type specified in manufacturer's product literature for indicated tank size, with wall anchoring devices for indicated wall type.
- B. Extinguisher Brackets: Formed steel, chrome-plated.

## **PART 3 EXECUTION**

### **3.01 EXAMINATION**

- A. Verify existing conditions before starting work.
- B. Verify rough openings for cabinet are correctly sized and located.

### **3.02 INSTALLATION**

- A. Install in accordance with manufacturer's instructions.
- B. Coordinate size of fire protection cabinets to ensure that type and capacity of fire extinguishers indicated are accommodated.
- C. Coordinate sizes and locations of fire protection cabinets with wall depths.

- D. General: Install fire protection cabinets in locations and at mounting heights indicated or, if not indicated, at heights below acceptable to authorities having jurisdiction and as required by referenced accessibility regulations.
  - 1. Fire Protection Cabinets: Install cabinets such that the door handle and fire extinguisher handles are no higher than 40 -inches above finish floor.
  - 2. handles are no higher than 40 -inches above finish floor.
  - 3. Verify cabinet projection dimensions and mount in accordance with ADA path-of-travel requirements including vertical clearances and control operation heights.
- E. In fire-rated walls, coordinate cabinet installation to maintain fire rating of wall.
- F. Secure rigidly in place.
- G. Place extinguishers in cabinets.

### **3.03 COORDINATION WITH RELATED WORK**

- A. Coordinate with pertinent sections for installation of Acoustic Barrier materials outside cabinet assemblies to meet acoustic rating of wall assembly where cabinet is located. Coordinate to ensure Acoustic Barrier materials are concealed inside wall construction.
- B. Coordinate with pertinent sections for installation of firestopping materials outside cabinet assemblies to meet fire rating of wall assembly where cabinet is located. Coordinate to ensure firestopping is concealed inside wall construction.

### **3.04 ADJUSTING AND CLEANING**

- A. Remove temporary protective coverings and strippable films, if any, as fire protection cabinets are installed unless otherwise indicated in manufacturers written installation instructions.
- B. Adjust fire protection cabinet doors to operate easily without binding. Verify that integral locking devices operate properly.
- C. On completion of fire protection cabinet installation, clean interior and exterior surfaces as recommended by manufacturer.
- D. Touch up marred finishes, or replace fire protection specialties that cannot be restored to factory-finished appearance. Use only materials and procedures recommended or furnished by fire protection cabinet and mounting bracket manufacturers.
- E. Replace fire protection specialties that have been damaged or have deteriorated beyond successful repair by finish touchup or similar minor repair procedures.

### **3.05 SCHEDULES**

- A. Location: Kitchens and food preparation areas, Type K.
- B. Location: Assemblies and Administrative areas: Type 2A-10-BC.

**END OF SECTION**

**SECTION 10 5113  
METAL LOCKERS**

**PART 1 GENERAL**

**1.01 SECTION INCLUDES**

- A. Metal lockers.

**1.02 RELATED REQUIREMENTS**

- A. Section 03 3000 - Cast-in-Place Concrete: Concrete base construction.
- B. Pertinent sections specifying wall framing and blocking for attachment of lockers.

**1.03 REFERENCE STANDARDS**

- A. ADA Standards - Americans with Disabilities Act (ADA) Standards for Accessible Design; 2010.
- B. ASTM A653/A653M - Standard Specification for Steel Sheet, Zinc-Coated (Galvanized) or Zinc-Iron Alloy-Coated (Galvannealed) by the Hot-Dip Process; 2015.

**1.04 SUBMITTALS**

- A. See Section 01 3300 - Submittals, for submittal procedures.
- B. Product Data: Manufacturer's published data on locker construction, sizes and accessories.
- C. Shop Drawings: Indicate locker plan layout in both elevation and section, numbering plan.
  - 1. Indicate field verified dimensions. Draw details of connecting components, fillers, trim, base and accessories, including engineered system of seismic restraint for lockers.
- D. Samples: Submit two samples 3 by 3 inches (\_\_\_ by \_\_\_ mm) in size showing color and finish of metal locker material.
- E. Manufacturer's Installation Instructions: Indicate component installation assembly.

**1.05 DELIVERY, STORAGE, AND HANDLING**

- A. Protect locker finish and adjacent surfaces from damage.

**PART 2 PRODUCTS**

**2.01 MANUFACTURERS**

- A. Metal Lockers:
  - 1. Art Metal Products: [www.artmetalproducts.com/#sle](http://www.artmetalproducts.com/#sle).
  - 2. De Bourgh Manufacturing Company, La Junta, CO: [debourgh.com](http://debourgh.com).
  - 3. List Industries, Inc: [www.listindustries.com/#sle](http://www.listindustries.com/#sle).
  - 4. Substitutions: See Section 01 6000 - Product Requirements.

**2.02 DESIGN REQUIREMENTS**

- A. Structural: Provide structurally engineered system of seismic restraint for lockers to resist over-turning of lockers. Calculations to comply with seismic requirements of C.C.R., Title 24, Part 2, California Building Code.
- B. Security: Manufacturer shall design ventilation penetrations and door latching devices (if provided) to prevent unauthorized door operation from locker exterior without a key.
- C. Accessibility: Comply with CBC Chapter 11 and ADA Standards.



- D. Provide lockers produced by a single manufacturer, including necessary mounting accessories, fittings, and fastenings

### 2.03 METAL LOCKERS

- A. Lockers: Factory assembled, made of formed sheet steel, ASTM A653/ A653M SS Grade 50/340, with G90/Z275 coating, stretcher leveled; metal edges finished smooth without burrs; baked enamel finished inside and out.
1. Where ends or sides are exposed, provide flush panel closures.
  2. Provide filler strips of minimum 18 gage metal and finished to match locker units, where indicated and where necessary to fill gaps between units, securely attached to lockers.
  3. Provide ventilation openings at top and bottom of each locker.
  4. Form recess for operating handle and locking device.
  5. Finish edges smooth without burrs.
  6. Fabricate sloped metal tops, ends and closure pieces
- B. Locker Body: Formed and flanged; with steel stiffener ribs; electric spot welded.
1. Body and Shelves: 16 gage, 16 inch (\_\_\_ mm).
  2. Base: 20 gage, 0.036 inch (0.9 mm).
  3. Metal Base Height: 4 inch (100 mm).
- C. Frames: Formed channel shape, welded and ground flush, welded to body, resilient gaskets and latching for quiet operation.
1. Door Frame: 16 gage, 0.0598 inch (1.52 mm), minimum.
- D. Doors: Hollow double pan, sandwich construction, 1-3/16 inch (30 mm) thick; welded construction, channel reinforced top and bottom with intermediate stiffener ribs, grind and finish edges smooth.
1. Door Outer Face: 14 gage, 14 inch (\_\_\_ mm), minimum.
  2. Door Inner Face: 20 gage, 0.0359 inch (0.91 mm), minimum.
  3. Form recess for operating handle and locking device.
- E. Hinges: Heavy duty, 7-knuckle type; two for doors under 42 inches (1 050 mm) high; three for doors over 42 inches (1 050 mm) high. Weld securely to locker body and door.
- F. Sloped Top: 20 gage, 0.0359 inch (0.91 mm), with closed ends.
- G. Trim: 20 gage, 0.0359 inch (0.91 mm).
- H. Coat Hooks: Stainless steel or zinc-plated steel.
- I. Number Plates: Provide oval shaped aluminum plates. Form numbers 1 inch (\_\_\_ mm) high of block font style with ADA designation, in contrasting color.
1. Number lockers in sequence as directed by Owner.
  2. Attach plates to each locker door, near top, centered, with at least 2 fasteners of same finish as number plate.
- J. Latching: 3/16 x 1-inch steel lever handle, Vandal Proof.
1. Two point minimum latching at all lockers. 3-point, 3-side cremone lever handle latching at wardrobe doors.
  2. Fabricate for padlock latching at typical units and furnish with built-in combination locks with ADA key operation (Master Lock model 1636MKADA) at ADA compliant units.
  3. Locking device at typical units supplied by Owner.

### 2.04 ACCESSORIES

- A. Each Locker: Provide at all lockers except box-type:

1. Two single prong wall hooks
  2. Hat shelf.
- B. Fasteners and anchors: Stainless steel, sizes and types to suit substrates and resist imposed loads, as recommended by the Locker Manufacturer.

## **2.05 FACTORY FINISHES**

- A. Clean, degrease, and neutralize metal; prime and finish with one coat of baked enamel, all surfaces exposed and concealed, except plates and non-ferrous metal.
- B. Color as selected by Architect from manufacturer's standards.
- C. Unless otherwise indicated, concealed parts may be manufacturer's standard neutral color.
- D. Paint locker units 1 color, as selected.
- E. Mens (Boys) and Womens (Girls) lockers shall have separate color selections.

## **PART 3 EXECUTION**

### **3.01 EXAMINATION**

- A. Verify that prepared bases are in correct position and configuration.
- B. Verify bases and embedded anchors are properly sized.

### **3.02 INSTALLATION**

- A. Install in accordance with manufacturer's instructions in configurations indicated.
- B. Mounting Heights and Locations: As required by accessibility regulations and as indicated on drawings.
- C. Place and secure on prepared base.
- D. Install lockers plumb and square.
- E. Secure lockers with anchor devices to suit substrate materials. Minimum Pullout Force: 100 pounds (445 N).
- F. Bolt adjoining locker units together to provide rigid installation.
- G. Install end panels, filler panels, and sloped tops. Provide flush, hairline joints against adjacent surfaces.
- H. Install fittings if not factory installed.
- I. Replace components that do not operate smoothly.

### **3.03 CLEANING**

- A. Clean locker interiors and exterior surfaces.
- B. Adjust doors and latches to operate easily without binding.
- C. Touch-up marred finishes. Replace units which cannot be restored to factory-finished appearance.
- D. D. Protect completed work until Owner's occupancy.

**END OF SECTION**

**SECTION 10 5626**  
**MOBILE STORAGE SHELVING**

**PART 1 GENERAL**

**1.01 SUMMARY**

- A. Section includes high density storage units and the following:
  - 1. Mechanically assisted, carriage mounted high-density mobile storage units, support rails, fabrication, and installation including leveling of support rails.
  - 2. Four-post shelving units installed on mobile carriages.
  - 3. Design services to complete final configuration of storage unit configuration and location of accessories.

**1.02 RELATED SECTIONS**

- A. Pertinent Sections specifying Volatile Organic Compound (VOC) Content Restrictions.
- B. Section 01 8113 "Sustainable Design Requirements".
- C. Section 03 3000 "Cast-in-Place Concrete" for coordination for preparation for slab on grade installations.
- D. Division 9: Sections specifying floor finishes and base materials.

**1.03 REFERENCES**

- A. California Code of Regulations, Title 24, Part 11 California Green Building Standards Code, "CAL-Green".
- B. California Code of Regulations, Title 24, Part 2, California Building Code (CBC), International Building Code, with California Amendments.
- C. ADA Standards - Americans with Disabilities Act (ADA) Standards for Accessible Design 2010
- D. C.C.R., Title 24, Part 2, California Building Code for Accessibility Standards, Chapter 11B.

**1.04 SUBMITTALS**

- A. Product Data: Submit manufacturer's product literature and installation instructions for each type of shelving, track and installation accessory required. Demonstrate compliance with specified attributes.
- B. CAL-GREEN Submittals:
  - 1. Product Data - VOC Limits: For adhesives sealants, fillers and primers, documentation including printed statement of VOC contents, comply with limits specified in referenced section.
  - 2. Composite Wood Formaldehyde Limits: Provide certification that all products meet current CARB Airborne Toxic Control Measure (ATCM) for Composite Wood Formaldehyde Limits by Mandatory Compliance Dates as specified in referenced section.
- C. Shop Drawings: Show fabrication, assembly, and installation details including descriptions of procedures and diagrams. Show complete extent of installation layout including clearances, spacings, and relation to adjacent construction in plan, elevation, and sections.
  - 1. Indicate clear exit and access aisle widths; access to concealed components; assemblies, connections, attachments, reinforcement, and anchorage; and deck details, edge conditions, and extent of finish flooring within area where units are to be installed.

2. Include installed weight, load criteria, furnished specialties, and accessories.
  3. Provide layout, dimensions, and identification of each unit corresponding to sequence of installation and erection procedures. Specifically include the following:
    - a. Location, position and configuration of tracks on all floors.
    - b. Plan layouts of positions of carriages, including all required clearances.
    - c. Details of shelving, indicating method and configuration of installation in carriages.
  4. Provide location and details of anchorage devices to be embedded in or fastened to other construction.
  5. Provide installation schedule and complete erection procedures to ensure proper installation.
  6. Show installation details at non-standard conditions.
- D. Delegated-Design Submittal: For items indicated to comply with performance requirements and design criteria, including analysis data signed and sealed by the qualified professional engineer responsible for their preparation.
- E. Selection Samples: For selection of colors and textures, submit manufacturer's color charts consisting of actual product samples, showing full range of colors and textures available. Provide a minimum of 12 color selections in powder coat paint finish.
- F. Verification Samples: Provide minimum 3 inch (76MM) square example of each color and texture on actual substrate for each component to remain exposed after installation.

#### **1.05 INFORMATIONAL SUBMITTALS**

- A. Manufacturer Qualifications: ISO 14001:2004 certified. Submit manufacturer's ISO 14001:2004 registration certificate, certifying the environmental performance of manufacturer.
- B. Welding certificates.
- C. Installer Certificates: Furnish signed certification by manufacturer attesting that installers comply with specified requirements. Submit manufacturer's certification that products comply with requirements of the contract documents.
- D. Project Schedule: Provide a project achievement plan detailing all critical elements necessary to plan, manufacture, ship, and install shelving product.
- E. Reference List: Provide a list of three (3) minimum installed mobile storage installations which may be contacted or visited by owner, architect and contractor. Installation must be of similar size, scope of specified system. Manufacturer is required to address all issues raised by owner, architect and contractor about operation, quality of installation and verify the suitability of manufacturer's products and comparison with materials and products specified. List must include contact names, phone numbers or e-mails, size and quantity of shelving units.
- F. Warranty: Submit draft copy of proposed warranty.
- G. Maintenance Data: Provide in form suitable for inclusion in maintenance manuals. Include operating and maintenance instructions, parts inventory listing, purchase source listing, emergency instructions, and related information.

#### **1.06 QUALITY ASSURANCE**

- A. Installer Qualifications: Engage an experienced installer who is authorized and certified by manufacturer's representative for the specified products.
  1. Minimum Qualifications: 3 years experience installing systems of comparable size and complexity to specified project requirements.

2. Guaranteed 24-hour service response time.

B. Professional Engineer Qualifications: Licensed Structural Engineer in the State of California.

#### **1.07 DELIVERY, STORAGE AND HANDLING**

A. Follow manufacturer's instructions and recommendations for delivery, storage and handling requirements.

#### **1.08 PROJECT CONDITIONS**

A. Field Measurements: Verify dimensions before fabrication. Indicate verified measurements on Shop Drawings. Coordinate fabrication and delivery to ensure no delay in progress of the Work.

B. Established Dimensions: Where field measurements cannot be made without delaying the Work, establish dimensions and proceed with fabricating mobile storage units. Coordinate construction to ensure actual dimensions correspond to established dimensions.

C. Sequence & Scheduling: Sequence mobile carriage and storage shelving system installation with other work to minimize possibility of damage and soiling during remainder of construction period.

D. Pre-Installation Conference: Conduct conference at project site. Review methods and procedures related to installation of mobile carriage and storage units including, but not limited to, the following:

1. Inspect and discuss condition and levelness of flooring and other preparatory work performed under other contracts.
2. In addition to the Contractor/ installer, arrange for the attendance of the following:
  - a. Other Installers affected by the work of this section.
  - b. The Owner's Representative.
  - c. The Architect.

#### **1.09 SEQUENCING AND SCHEDULING**

A. Sequencing: Coordinate installation with other work to minimize possibility of damage and soiling during remainder of construction period.

B. Scheduling: Plan installation to commence after interior finishing operations, including painting, have been completed.

C. Built-In Items: Provide components which must be built in to cause no delay in general progress of the Work.

D. Pre-installation Conference: Schedule and conduct conference on project site to review methods and procedures for installing mobile storage units including, but not limited to, the following:

1. Review project conditions and levelness of flooring and other preparatory work performed under other contracts.
2. Review and verify structural loading limitations.
3. Recommended attendees include:
  - a. Owner's Representative.
  - b. General Contractor.
  - c. Architect.
  - d. Manufacturer's representative.

- e. Subcontractors or installers whose work may affect, or be affected by, the work of this section.

#### **1.10 WARRANTY**

- A. Provide a written warranty, executed by Contractor, Installer, and Manufacturer, agreeing to repair or replace units which fail in materials or workmanship within the established warranty period. This warranty shall be in addition to, and not a limitation of, other rights the Owner may have under General Conditions provisions of the Contract Documents.
- B. Lifetime Limited Warranty: For the lifetime of the shelving and mobile carriages (“structural frames”). For the purposes of this warranty, structural frames shall be deemed to exclude all moving parts, controls and guides that have immediate contact with any moving parts.
- C. 5-year Limited Warranty: For five (5) years from the date of acceptance by the Owner, for all equipment, other than structural frames and motors. During the 5-year warranty period, all parts are included at no cost for 5 years. Labor installation is included at no cost during the first year of the 5-year warranty period.

#### **1.11 MAINTENANCE**

- A. Provide manufacturer’s extended maintenance agreement for 12 months, commencing on the day the standard maintenance warranty ends.

### **PART 2 PRODUCTS**

#### **2.01 SYSTEM DESCRIPTION**

- A. General: The system consists of manufactured mobile storage units mounted on track-guided carriages to form a compact system. Design permits access to any single aisle by manually moving units until the desired aisle is opened. Provide uniform carriage movement along the total length of travel, even with unbalanced loads.
- B. Carriage System Design and Features: The carriage system consists of a formed structural steel frame with machined and balanced wheels riding on steel rails recessed to the floor. Rail types, quantities and spacing as selected by the manufacturer to suit installation conditions and requirements to ensure smooth operation and self-centering of mobile storage units during travel without end play or binding. All bearings used in the drive mechanism shall be permanently shielded and lubricated.
- C. Movement Controls: Control handles shall be provided on both ends, centered on the end panel of each unit to permit units to be moved to create a single aisle opening.
- D. Drive / Guide System:
  - 1. Prevent carriage slipping, binding and excessive wheel/ rail wear under normal operation.
  - 2. Guides: Provide at minimum 2 locations.
  - 3. Bearing Surfaces: Provide rotating load-bearing members with ball or roller bearings.

#### **2.02 PERFORMANCE REQUIREMENTS**

- A. VOC Limits for adhesives sealants, fillers, coatings and primers. Comply with limits specified in related Section.
- B. Composite Wood products must meet current CARB Airborne Toxic Control Measure (ATCM) for Composite Wood Formaldehyde Limits by Mandatory Compliance Dates as specified in related Section.

- C. Delegated Design: Design mobile storage systems, including comprehensive engineering analysis by a qualified professional engineer, using performance requirements and design criteria indicated.
  - 1. Ease of Movement: Provide units capable of being moved by exerting a maximum horizontal force of 5 pounds.
  - 2. Seismic Performance: Provide mobile storage units capable of withstanding the effects of earthquake movement when required by applicable building codes.

### 2.03 MANUFACTURERS

- A. Basis of Design Product: Mayline Co. LLC; Mobile Aisle 1000, mechanical assist mobile shelving system: [www.mayline.com](http://www.mayline.com) <<http://www.mayline.com>>.
- B. Subject to compliance with requirements, products by one of the following may be acceptable:
  - 1. Aurora Storage Products, Inc.; Mechanical Assist Mobile 1000: [www.aurorastorage.com](http://www.aurorastorage.com).
  - 2. Montel Inc.; Mobilex Mechanical Assist Movable Shelving System: [www.montel.com](http://www.montel.com).
  - 3. Spacesaver Corporation; [www.spacesaver.com](http://www.spacesaver.com).
  - 4. Substitutions: Section 01 6000.
- C. Source Limitations: Obtain mobile storage systems including shelving from single manufacturer.

### 2.04 STORAGE SYSTEM CONFIGURATIONS

- A. Layout and capacity as shown on Drawings.

### 2.05 MATERIALS

- A. General: Provide materials and quality of workmanship which meet or exceed established industry standards for products specified. Material thicknesses/gauges are manufacturer's option unless indicated otherwise.
- B. Plastic Laminates: NEMA LD-3, GP-28, Vertical Grade.
- C. Grout: Provide non-shrink, non-staining hydraulic cement compound conforming to the following requirements, based on the performance of the test specimens at room temperature and in laboratory air.
  - 1. Linear Movement: No shrinkage while setting; maximum expansion limited to .002inches per linear inch.
  - 2. Compressive Strength: Based on two inch cubes made following ASTM standards, tested on a Balding-Southward machine of 60,000 pounds capacity, meet or exceed the following strength:
    - a. 1 hour: 4,500 psi
    - b. 7 days: 8,000 psi

### 2.06 MANUFACTURED COMPONENTS

- A. Rails: Material: ASTM/AISI Type 1035 or 1045 steel.
  - 1. Capacity: 1,000 pounds per lineal foot (1385kg/M) of carriage.
  - 2. Minimum Contact Surface: 5/8 inch (16MM) wide.
  - 3. Provide rail sections in minimum 6 foot (1.83M) lengths.
  - 4. Rail configuration shall permit attachment to top of structural floor system with provision for leveling rails to compensate for variations in floor surface level.

5. Provide rail connections designed to provide horizontal and vertical continuity between rail sections, to gradually transfer the concentrated wheel point load to and from adjoining rail sections. Butt joints are not permitted.
  6. Tracks shall be layered and staggered to ensure a smooth weight transfer from one track to the other. Top-to-bottom track shall be without joints to support continuously the top steel rail at the junction point and provide greater structural rigidity.
  7. Anti-Tip Rail Form Covers: Manufacturer shall provide for protection to prevent damage to rails during concrete back pours when anti-tip devices are installed and meet seismic requirements of prevailing building code.
- B. Carriages: Welded or bolted steel construction. Riveted carriages are unacceptable. 1,000 pound per foot (1385kg/M) minimum capacity.
1. Provide fixed carriages of same construction and height as the movable carriages, anchored to rails. Setting fixed shelving directly on floors is not permitted.
  2. Where splices are required due to size, provide bolted carriage splices designed to maintain proper unit alignment and weight load distribution.
  3. Design carriages to allow the shelving uprights to recess and interlock into the carriages a minimum of 3/4 inch (19MM). Top mount carriages are unacceptable.
  4. Provide each carriage with two wheels per rail.
  5. Carriage face sections shall provide a smooth, clean appearance without any assembly holes or protruding hardware.
  6. No shelving or cabinet attachment hardware shall be visible on exterior face of carriages
  7. Each carriage shall have two wheels per rail.
  8. Carriages shall have powder coat finish on all surfaces. Color to match shelving. Powder coat paint finish is required for finish durability and elimination of any off gassing. Finish shall be inert, with no volatiles present in finished product. Visible galvanized steel structural carriage components are unacceptable.
  - 9.
- C. Drive and Guide System:
1. Design: Provide full-length drive shaft which prevents carriage whipping, binding and excessive wheel and rail wear under normal operation.
  2. Torque-Resistant Tubular Drive Shaft: Minimum of 1 5/16" (33mm) outside diameter by maximum 1 1/8" (29mm) inside diameter.
  3. Dual-Flange Wheels to provide positive guidance and tracking.
- D. Wheels:
1. Constructed of solid cold rolled steel for smooth operation. Minimum load capacity per wheel 3,200 pounds (1,452kg). All bearings shall be permanently shielded and lubricated
  2. Size: Minimum 5 inches (127MM), outside diameter drive wheels, dual-flanged and sloped to insure efficient guidance.
  3. Guide Wheels: All wheel locations.
- E. Seismic Anti-Tip Devices: Provide system employing in-rail, seismic anti-tip devices at each wheel location.
- F. Face Panels Materials: All exposed face panels shall be steel. Provide face panels on all operating ends of ranges.
1. Finishes: As selected by the Architect.
  2. Face panels must cover the full height and width of shelving.
- G. Movement Controls:
1. Mechanical assist type having a chain sprocket drive system. Provide driving system delivering uniform movement along the total length of the carriage even with unbalanced



loads on the carriage. Ensure positive drive without play in the drive handle, capable of stopping the carriage without drifting. All components of the system shall be compatible for smooth non-jerking, even movement along the total length of the carriage. Drive system shall have a minimum gear ratio requiring 1 pound of pressure to move a load of 6000 pounds. All bearings used in the drive mechanism shall be permanently shielded and lubricated.

2. Operating handles: Three-spoke type with zinc construction (single spoke are unacceptable) at 12 inch or 18  $\frac{3}{4}$  inch diameter transmitting power through a chain drive to the drive wheels. Provide operating handles on drive end of carriages as noted on drawings. Provide each mechanical device with a chain-tensioning adjuster.

H. Safety Features:

1. Locking flip-down latch : Shall be located on the handle. The user shall flip down the locking latch, which will lock the respective carriage. When engaged, the locking latch will display red with visible 'LOCKED' visible to users. Both carriages on each side of the aisle must be manually secured.
2. Toe-level Safety Sweep: For single or dual access as appropriate for configuration(s) indicated. Consisting of hinged aluminum safety bar running full length of the mobile carriages, flush with bottom of carriage frame and on both sides of carriage. Upon activation of the sweep, an internal device shall interlock with drive train resulting in positive stop anywhere in the module. A one and a half (1.5) pound pressure applied on the safety bar will activate the safety. The safety shall automatically reset upon removal of the obstruction or if carriage is backed away from the obstruction. This active safety shall not require any electricity or battery to be activated (mandatory).]
3. Mechanical Floor Locking Device (for single access): Once engaged after a key rotation, this plunger device will engage into the floor or rail.

I. Shelving: Design: Wedge-lock type consisting of uprights, shelves, and shelf supports, designed to be assembled without fasteners or clips. Shelves shall not have any holes on exposed surfaces. Front and back flanges shall be flush with outside faces of posts. Design shall permit individual shelf adjustment and/or removal anywhere along the entire height of uprights.

1. Materials and Workmanship: Fabricate units from Class 1, cold-rolled steel sheet with all bends sharp and true and no exposed "knife" edges.
  - a. All units shall be free of burrs, sharp edges and projecting hardware with smooth, non-abrasive surfaces and edges.
  - b. After fabrication, shelving shall exhibit no dents, "oil canning", buckling or other surface irregularities.
2. Uprights: Formed from steel sheet to a hollow "tee" shape for intermediate supports and formed angles for end supports. Uprights shall have keyhole slots on inner wall only. Provide with sheet steel panels full height and depth of end uprights. Provide intermediate "tee" uprights between adjacent units.
3. Shelves: Form from sheet steel with flanges on all sides and return hem on front and back flanges. Ends shall be formed to clear inside of upright offset panels. Shelves shall be independently adjustable. Provide all shelves with slots for file dividers.
4. Canopy Tops: Same construction as shelf units.
5. Shelf Supports: Form from heavy gauge steel sheet with four solid steel shoulder rivets, two per ear, that interlock with inner wall of uprights.
6. File dividers: Provide minimum two adjustable file dividers for each opening.
7. Provide one pull out reference shelf at each open aisle.
8. Shelves must have minimum 1-1/2 inch vertical adjustability.

9. Load Carrying Capabilities: Provide shelf units capable of supporting 40 pounds per lineal foot (18kg/305MM) with maximum deflection of L/140. Shelves shall exhibit no permanent deflection under fully loaded conditions.
  10. Color to be selected from manufacturers standard color card. Both smooth and textured surfaces must be available
- J. Accessories:
1. Overhead Aisle Lighting: Each aisle shall be equipped with automatic or manual lighting. Lighting system shall illuminate upon activation of: [human presence detector] [magnetic proximity detector] [rocker switch] .]
  2. Waist High Carriage Locks: Provide manufacturer's standard.

## **2.07 FINISHES**

- A. Powder Coat Paint Finish: Parts to be cleaned in a six stage surface prep machine prior to coating, including:
1. Finish Characteristics:
    - a. Gloss: 50 - 60 degrees
    - b. Impact Resistance: 160 in. lbs.
    - c. Flexibility: 180 degrees, 1/4" mandrel
    - d. Pencil Hardness: 2H
    - e. Cross Hatch Adhesion: 100%
- B. Colors and Patterns of All Finishes: As selected by the Architect from manufacturer's standard options.
- C. Laminate Finish: Provide factory applied laminate panels.
- D. Edgings: Provide preformed edging, color-matched to unit colors selected.

## **2.08 FABRICATION**

- A. General: Coordinate fabrication and delivery to avoid delay in progress of the Work.
- B. Wheels: Provide precision machined and balanced units with permanently shielded and lubricated bearings.
- C. Carriages: Fabricate to ensure no more than 1/4 inch (6MM) maximum deviation from a true straight line. Splice and weld to ensure no permanent set or slippage in any spliced or welded joint when exposed to forces encountered in normal operating circumstances.

## **PART 3 EXECUTION**

### **3.01 EXAMINATION**

- A. Examine floor surfaces with Installer present for compliance with requirements for installation tolerances and other conditions affecting performance of mobile storage units.
- B. Verify that building structural system is adequate for installing mobile storage units at locations indicated on approved shop drawings.
1. In new construction, ensure that recesses for rails in floors are at proper spacing and depths, with allowance for grouting.
- C. Verify that intended installation locations of mobile storage units will not interfere with nor block established required exit paths or similar means of egress once units are installed.
- D. Prepare written report, endorsed by Installer, listing conditions detrimental to proper performance of mobile storage units, once installed.

- E. Proceed with installation only after unsatisfactory conditions have been corrected.

### 3.02 INSTALLATION

- A. Install components and accessories after construction finishing activities, including interior painting, have been completed. Install shelving units to comply with final layout drawings, in strict compliance with manufacturer's printed instructions and structural calculations. Position unit's level and plumb at proper location relative to adjoining units and related work
- B. Rails:
1. Lay out rails using full length units to the maximum extent possible. Use cut lengths only at ends to attain total length required. Locate and position properly, following dimensions indicated on approved shop drawings. Verify thickness of finished floor materials to be installed and install level 1/6 inch (1.6MM) above finished floor surfaces.
  2. Verify level, allowing for a minimum 1/4 inch (6MM) of grout under high points. Position and support rails so that no movement occurs during grouting.
  3. All tracks shall be grouted the entire length of each run, including all track joints. As the grout slightly expands during the cure process, it shall be in permanent contact with the grouted structural members to provide continuous support to the system and optimal weight distribution on the existing floor slab.
  4. Set rails in full grout bed, completely filling any voids entire length of all rails including rail connectors. Trim up sides flush with rails to ensure proper load transfer from rail to supporting floor. Using shims in lieu of full grouting is not permitted.
  5. Installation Tolerances: Do not exceed levelness of installed rails listed below:
    - a. Maximum Variation From True Level Within Any Module: 3/32 inch (2.4MM).
    - b. Maximum Variation between Adjacent (Parallel) Rails: 1/16 inch (1.6MM), perpendicular to rail direction.
    - c. Maximum Variation in Height: 1/32 inch (.8MM), measured along any 10 foot (3.05M) rail length.
  6. Verify rail position and level; anchor to structural floor system with anchor type and spacings indicated on approved shop drawings.
- C. Shelving Units Installation:
1. General: Follow layout and details shown on approved shop drawings and manufacturer's printed installation instructions. Position units level, plumb; at proper location relative to adjoining units and related work.
  2. Carriages:
    - a. Place movable carriages on rails. Ensure that all wheels track properly and centering wheels are properly seated on centering rails. Fasten multiple carriage units together to form single movable base where required.
    - b. Position fixed carriage units to align with movable units.
  3. Shelving Units:
    - a. Permanently fasten shelving units to fixed and movable carriages with vibration-proof fasteners.
    - b. Stabilize shelving units following manufacturer's written instructions. Reinforce shelving units to withstand the stress of movement where required and specified.

### 3.03 FIELD QUALITY CONTROL

- A. Verify shelving unit alignment and plumb after installation. Correct if required following manufacturer's instructions.

- B. Remove components which are chipped, scratched, or otherwise damaged and which do not match adjoining work. Replace with new matching units, installed as specified and in manner to eliminate evidence of replacement.

**3.04 ADJUSTING**

- A. Repair damaged and defective work and eliminate functional and visual defects. Where repair is not possible replace work. Adjust joints for uniform appearance. No unfinished surfaces or irregularities in completed work.
- B. Adjust movable elements for smooth operation.

**3.05 CLEANING**

- A. Immediately upon completion of installation, clear components and surfaces. Remove surplus materials, rubbish and debris resulting from installation upon completion of work and leave areas of installation in neat, clean condition.

**3.06 DEMONSTRATION/TRAINING**

- A. Schedule and conduct demonstration of installed equipment and features with Owner's personnel.
- B. Schedule and conduct maintenance training with Owner's maintenance personnel. Training session should include lecture and demonstration of all maintenance and repair procedures that end user personnel would normally perform.

**3.07 PROTECTION**

- A. Protect system against damage during remainder of construction period. Advise Owner of additional protection needed to ensure that system will be without damage or deterioration at time of substantial completion.

**END OF SECTION**

## SECTION 11 4000

### FOODSERVICE EQUIPMENT

#### PART 1 GENERAL

##### 1.01 RELATED DOCUMENTS

- A. Drawings and general provisions of the Contract, including General and Supplementary Conditions and Division 1 Specifications Sections, apply to this Section.

##### 1.02 SUMMARY

- A. This section included the following:
  - 1. Foodservice equipment works as indicated on the drawings and by equipment schedule at the end of this section.
  - 2. Drawings, the provisions of the Agreement, the General Conditions, and the Division 1 specifications sections apply to all work of this section.
  - 3. Substitutions: Substitute products will be considered only under the terms and conditions of Division 1.
  - 4. Substitutions: Proposals for alternate products and methods for applications indicated may be considered by the Architect, subject to requirements of Division 1, system performance requirements and applicable PART 1 requirements of this Section.
- B. Related Sections
  - 1. There are no related Sections.

##### 1.03 ACTION SUBMITTALS

- A. Product Data: For each type of product indicated.
- B. Shop Drawings
  - 1. For fabricated equipment. Include plans, elevations, sections, rough-in dimensions, fabrication details, utility service requirements, and attachment to other work.
  - 2. File names shall conform to CSI MasterFormat 2011.

##### 1.04 INFORMATIONAL SUBMITTALS

- A. Coordination Drawings: For foodservice facilities. Drawings are to be submitted in PDF format.
  - 1. Equipment floor plan and schedule.
  - 2. Electrical rough-in plan and schedule.
  - 3. Plumbing rough-in plan and schedule.
  - 4. Elevation drawings of foodservice equipment.
- B. Equipment Spec Books
  - 1. Provide foodservice equipment spec sheets in order of list of kitchen equipment shown in written specifications and labeled with the appropriate item number. Highlight accessories and voltages as appropriate on the spec sheets. If factory spec sheets are not available, indicate relevant information (size, plumbing requirements and electrical requirements) on white sheet. Gather spec sheets from the owner for owner supplied equipment and insert in spec book. Provide in PDF format.

### 1.05 CLOSEOUT SUBMITTALS

- A. Maintenance Manuals
  - 1. Provide a PDF with the project address and "Foodservice Operation & Maintenance Manuals" on the front page. Include information for each piece of equipment with electrical or gas connections. Information should include operation instructions, cleaning and maintenance instructions, parts listing if available, list of service agencies (names, addresses and phone numbers) authorized to repair the equipment, voltage, gas type, refrigerant used, serial number and copies of the warranties. List should be sorted alphabetically by manufacturer.

### 1.06 QUALITY ASSURANCE

- A. Certify that all work and materials comply with Federal, State, and Local laws, ordinances and regulations and is confirmed by the local inspector having jurisdiction.
- B. Work and materials must be in full accord and when appropriate, shall be listed with the following agencies:
  - 1. Local Health Department
  - 2. National Sanitation Foundation (N.S.F.)
  - 3. Underwriter Laboratories (U.L.) or ETL equivalent.
  - 4. American Gas Association (A.G.A.)
  - 5. N.F.P.A. - latest edition, for exhaust system.
- C. Qualifications
  - 1. Kitchen Equipment Contractor (KEC) and its sub-contractors to have at least five (5) years experience in this type of work. Upon request provide at least three references for jobs of similar size and content.
  - 2. Commercially manufactured equipment is not acceptable unless evidence is furnished that similar equipment has been operation successfully in a minimum of three (3) installations (excluding testing laboratories, field testing, or prototypes) for at least one (1) year.
  - 3. Commercially manufactured equipment will be reviewed base on submittal data provided on manufacturer's literature and/or manufacturer's shop drawing for prime alternate or substituted items. Failure of the equipment to meet the capacity, operation, size, utility and production as submitted will result in the rejection of the equipment regardless of disclaimers.
  - 4. Custom fabricated equipment shall be manufactured by a foodservice equipment fabricator with at least five (5) years experience in this type of work, who has the plan, personnel, and engineering facilities to properly design, detail and manufacture quality foodservice equipment.
- D. Regulatory Requirements: Install equipment to comply with the following:
  - 1. ASHAE 15, "Safety Code for Mechanical Refrigeration."
  - 2. NFPA 54, "National Fuel Gas Code."
  - 3. NFPA 70, "National Electrical Code."
  - 4. NFPA 96, "Ventilation Control and Fire Protection of Commercial Cooking Operations."

### 1.07 WARRANTY

- A. All equipment shall be fully guaranteed against defects in workmanship and material for one (1) year after Owner's final acceptance. Refrigeration compressors shall be fully guaranteed for five (5) years. All repairs and replacement shall be made without charge to the Owner. Guarantee period shall commence with the first usage of the equipment for the intended purpose after final acceptance.

- B. Provide a warranty sheet in PDF format listing all the equipment by manufacturer, the model and serial number of the piece of equipment, and the authorized service agency for each piece of equipment. Include the service agency's phone number and email address.

## **PART 2 PRODUCTS**

### **2.01 GENERAL REQUIREMENTS OF FABRICATION**

- A. Fabrication shall conform to general acceptance of the foodservice industry.
- B. Fabrication shall meet or exceed National Sanitation Foundation standards including the latest editions and revisions.

### **2.02 MATERIALS**

- A. Stainless Steel (S/S): Stainless Steel shall be of U.S. Standard-gauges as indicated, but not less than 18-gauge or as note, Type 304 with No. 4 finish.
- B. Galvanized Steel: Galvanized steel shall be of 14-gauge and shall be electro galvanized. Galvanized steel shall be used in no-exposed areas, areas which have no contact with food or food serving items, and in framework, when used in framework, galvanized steel shall be all welded construction.
- C. Plastic Laminate (PL):
  - 1. Shall be Formica, Parkwood, LaminArt, or approved equal.
  - 2. Shall be veneered with approved waterproof and heatproof cement. Rubber base adhesives are not acceptable.
  - 3. Shall be directly applied over 3/4" plywood.
  - 4. Exposed faces and edges shall be faced with 1/16" thick material. Corresponding backs shall be covered with approved backing and balancing sheet material.
- D. Solid Surface Material (SSM):
  - 1. Shall be Granite, Caesarstone, Silestone or approved equal and installed over 3/4" plywood or metal bases. Provide air space, trim, and/or insulation around any heat or cold producing equipment to guard against discoloration and cracking.

### **2.03 METAL TOP CONSTRUCTION**

- A. Metal tops shall be one-piece 14-gauge welded construction, including field joints. Secure to a full perimeter galvanized steel channel frame crossed-braced not farther than 30 inches on center. Fasten top with stud bolt or tack welds.

### **2.04 ENCLOSED CABINET BASES**

- A. Bases shall be fabricated from not less than 18-gauge steel reinforced by forming the metal ends and shelves. Partitions shall be all stainless steel. The ends and vertical partitions may be of single wall construction, with a 2-inch face, all partitions and sides shall be welded in the intersection and flush with the bottom.
- B. Unexposed backs and structural members may be constructed of galvanized steel.
- C. Intermediate shelves shall be removable, except the bottom shelf when the cabinet is on legs. When the cabinet is on a masonry base, the bottom shelf shall be removable to all access for cleaning.

## 2.05 LEGS AND CROSS RAILS

- A. Legs and cross railings shall be 1-5/8", 16-gauge stainless steel tubing. All cross rails shall be continuously welded, ground and polished. Tack welds or other methods of connection are not acceptable. Bottoms of legs shall be wedged inward and fitted with a stainless steel bullet type foot, with not less than 2" adjustment. Freestanding legs shall be pegged to the floor with 1/4" stainless steel rod.
- B. Stainless steel gussets shall be not less than 3" diameter at top and 3-3/4" long. Outer shell 16-gauge stainless steel reinforced with 12-gauge mild steel inserts welded interior shell. Gussets shall be large enough to accommodate 1-5/8" tube with provision for Allen screw fastener.
- C. Adjustable foot shall be constructed of stainless steel 1-1/2" diameter tapered at the bottom to 1" diameter, fitted with threaded cold rolled rod for minimum 1-1/2" by 3/4" threaded busing plug welded to legs.

## 2.06 SHELVES

- A. When shelves are part of the fixture, the following shall apply:
  - 1. Open base type shelf shall be notched around the leg and continuously welded to the leg.
  - 2. Cabinet base type shelf shall be turned up on the back side a minimum of 1/4 inch radius and further slightly to insure a tight fit to enclosure panels.
- B. Wall shelves shall be one-piece 16-gauge welded construction, including field joints. Secure shelves with 14-gauge s/s brackets at 36-inch on-center maximum.
- C. Overshelf shall be one-piece 16-gauge welded construction, including field joints. Secure to 1-inch tubular supports at 60-inch center maximum attached to counter tops.

## 2.07 SINKS

- A. When multiple compartments are part of the design, they shall be continuous on the exterior without applied facing strips or panels, or separated by a minimum of 2". The bottom of each compartment shall be creased such as to ensure complete drainage to waste opening.
- B. Partitions between compartments shall be double thickness, continuous, and welded.
- C. Where sink bowls are exposed, the exterior shall be polished to a number 4 finish.
- D. Fabricator shall provide drains, wastes, and faucets as indicated on drawings, or itemized specifications.

## 2.08 OTHER FABRICATED EQUIPMENT

- A. Casters:
  - 1. Shall be heavy-duty type, ball bearing, solid or disc when with non-marking grease-proof rubber, neoprene or polyurethane tire.
  - 2. Wheel shall be 5-inch diameter, minimum wide of tread 1-1/2 inch, with a minimum capacity per caster of 250 lbs.
  - 3. Solid material wheels shall be provided with stainless steel rotating wheel guards.
  - 4. Shall be sanitary, have sealed wheel and swivel bearings and polish plate finish.
- B. Doors:
  - 1. Metal doors shall be double cases stainless steel. Outer pans shall be 18-gauge stainless steel with corners welded, ground smooth, and polished. Inner pan shall be 20-gauge stainless steel fitted tightly into outer pan with a sound deadening material such as Celotex



or Styrofoam used as a core. Doors shall finish approximately 3/4 inch thick.

2. Sliding doors shall be mounted on large, quite ball bearing rollers in 14-gauge stainless steel overhead tracks and be removable without the use of tools. Bottom of cabinet shall have stainless steel guide pins and not channel tracks for doors.
3. Hinged doors shall be mounted on heavy-duty NSF approved hinges, or as noted on plans and specifications.

C. Hardware:

1. Shall be solid heavy-duty type.
2. Door hardware shall be locking type, keyed and mater keyed.
3. Shall be identified with manufacturer's name and number so that broken or worn parts may be replaced.
4. Submit samples for approval when requested.
5. Pulls shall be Component Hardware or equal.

D. Drawer Assemblies:

1. Assemblies shall consist of removable drawer body mounted in a ball bearing slide assembly and padlock assembly.
2. Slide assemblies shall consist of one pair of roller bearing extension slides with slide and back enclosure panels, front space angle, and two drawer carrier angles secured to slides and stainless steel front.
3. Slides shall be 250-pound capacity made by Component Hardware or equal.
4. Drawer bodies for general storage shall be 20-inch by 20-inch with Royalite containers.
5. Drawers intended to hold food products shall be removable type with 12-inch by 20-inch stainless steel assembly.
6. Drawer fronts shall be double cased 3/4-inch thick, with 18-gauge stainless steel welded and polished front pan. Steel back pan is to be tightly fitted and tack welded.
7. All drawers shall be provided with replaceable soft neoprene bumpers or, for refrigerated drawers, a full perimeter soft gasket.

## 2.09 FABRICATED WORKMANSHIP

A. Items of specially fabricated equipment shall be fabricated by an acceptable manufacturer, which is NSF approved and fabricated in an approved manner to the complete satisfaction of the owner.

1. Welding and soldering:
  - a. Materials 18-gauge or heavier shall be welded.
  - b. Seams and joints shall be shop welded or soldered as the nature of the material may require.
  - c. Welds shall be ground smooth and polished to match original finish.
  - d. Where galvanizing has been burned off, the weld shall be cleaned and touched up with high-grade aluminum paint.

B. Fasteners and Joints:

1. The following will not be accepted:
  - a. Exposed screw or bolt heads.
  - b. Rivets.
  - c. Butt joints made by riveting straps under seams and then filled with solder.

C. Rolled Edges: Rolled edges shall be as detailed, with corners, bull nose, ground and polished.

D. Coved Corners: All stainless steel foodservice equipment shall have 1/2-inch or larger radius coves in all horizontal and vertical corners and intersections per NSF standards.

E. Closures: Where ends of fixtures, backsplashes, shelves, etc. are open, fill by forming the metal, or weld sections, if necessary, to close entire opening flush to walls or adjoining fixtures.

## 2.10 OPERATION REQUIREMENTS

- A. Insure quiet operation of foodservice and related equipment.
- B. Insure the bumper gaskets stop and any other needed protection is installed on all fabricated equipment as needed.

## 2.11 COLD STORAGE ROOMS

- A. Pre-fabricated, pre-assembled, sectional size and configuration as shown on plan, and as verified by field dimensions, with largest possible area provided.
- B. Check jobsite before installation of walk-in cooler/freezer to verify proper dimensions for all trim pieces.
- C. General:
  - 1. The urethane foam core of the panels shall be certified by Underwriter's Laboratories having tested and in accordance with UL Standard 723 (ASTM Standard E-84).
  - 2. The foam core of the panels shall be tested in accordance with ASTM Standard D-1929 to determine the self-ignition temperature.
  - 3. Panels shall be tested in accordance with ASTM Standards E-72, E-455 and E-564 for determination of the structural characteristics of the panel system.
  - 4. The foam insulation shall be tested in accordance with ASTM Standard C-177 to evaluate the insulation performance of the material.
  - 5. The urethane foam core must meet the Montreal Protocol for reduction of chlorofluorocarbons (CFCs).
  - 6. Certification of the above performance specifications must be provided by the indicated independent testing laboratory or by any other independent agency recognized by the major model building code agencies UBC, COCA, or the SBBC.
- D. Construction
  - 1. Interior and exterior metal skins formed with steel dies and roll-forming equipment. The metal skins shall be placed into steel molds and liquid urethane injected between them. Urethane shall be foamed in place (poured, not frothed) and, when completely heat-cured, shall bond to the metal skins to form a rigid thick insulated panel.
  - 2. Panels shall be equipped with "Cam-Lok" joining devices. The distance between locks shall not exceed 48-inches, or as specified. Press-fit caps shall be provided to close wrench holes.
  - 3. Exterior and interior finish per itemized specifications.
  - 4. Perimeter door heater shall be fitted with low-conductor, anti-sweat heater wires, fully enclosed in metal, easily replaceable, for freezer compartments.
  - 5. All interior joints coved ¼-inch minimum radius.
  - 6. All conduit and switch/alarm J-boxes to be pre-installed in panel sections with recess splice boxes at exterior ceiling panels.
  - 7. Doors:
    - a. Door to be 36-inch, hinged flush swing type door, or as specified on plans, with 4-inch insulation same as panels. 14-inch by 24-inch view windows in all doors, Heated on freezer doors. Interior and exterior to have 36-inch high diamond tread kick plate.
    - b. Chrome-plated positive door-latch and handle with interior safety release and mortise deadbolt lock assembly.
    - c. Three hinges per door, NSF-approved, chrome plated, self-closing from a 90-degree open position, cam-action.
    - d. Hydraulic door closure equal to Kason 1094.

- e. All doors accessing walk-ins are to have locks keyed alike.
  - 8. A heated relief port shall be provided at freezer to equalize the difference of pressure between the exterior and walk-in.
  - 9. Kason 1810EZ Fluorescent Light Fixture controlled by interior/ exterior light switch (3-way or 4-way).
  - 10. Digital temperature alarm system, with constant "LED" read-out display, audio warning buzzer, and remote sensor, with high-low setting and twisted pair data capability, equal or Modular Corp. Model #75.
- E. Provide permanently mounted trim and closure panels (of material to match exterior panel surfaces) between top of compartments and finished ceiling; and closure strips between wall panels and architectural walls or columns.

## 2.12 REFRIGERATION SYSTEMS

- A. Provide all refrigeration work through licensed refrigeration contractors.
- B. All refrigeration items shall be designed to maintain the following operating temperatures:
- |                               |              |
|-------------------------------|--------------|
| 1. Walk-in refrigerators      | 35 degrees F |
| 2. Walk-in freezers           | 0 degrees F  |
| 3. Reach-in refrigerators     | 35 degrees F |
| 4. Reach-in freezers          | 0 degrees F  |
| 5. Undercounter refrigerators | 35 degrees F |
| 6. Undercounter freezers      | 0 degrees F  |
| 7. Cold Pans                  | 35 degrees F |
- C. An evaporator coil defrost system must be provided by the Contractor on all walk-in refrigerators and freezer rooms operating at less than 35 degrees F.
- D. Hang blower coils per manufacturer's specifications with approved hangers at 4-inches from interior walk-in ceiling. Contractor shall provide a 12-gauge galvanized steel plate of suitable size and shape on the exterior roof of the walk-in box above the coil to support and spread the weight of the coil adequately.
- E. The drain line from freezers shall be wrapped with a continuous electrical heater tape and installed per manufacturer's suggest methods.
- F. Refrigeration tubing shall by Type L. ACR hard drawn degreased, sealed copper and shall be installed with horizontal runs sloped 1-inch per 20-feet towards the condensing units. All refrigerating piping shall be properly supported by adjustable hangers spaced and adjusted to the drop required. Where vertical runs of more than 5-feet occur in the suction line, the risers shall be trapped at the bottom. Piping is to be installed so that the refrigerant or oil cannot drain back into the coil from the suction line.
- G. All suction and refrigerant lines shall be insulated with minimum ½-inch Armstrong armaflex or equal cellular type insulation. Metal pipe sleeves shall be provided where piping passes through walls, ceiling, or floors. Space around the tubing shall be filled with mastic insulation compound. Install a permanent suction line filter in each compressor suction line with pressure fitting ahead of the filter to facilitate checking of the pressure drop through the filter. All penetrations through walk-in or freezer walls shall be fully insulated and sealed to be vapor tight to prevent condensation within any light fixtures, switch boxes, junction boxes, or any other fitting. Refrigeration and drain lines shall be fully sealed an provided with escutcheon plates by the installer per attached standard detail or better.
- H. Furnish and completely install a thermostat to control the refrigeration temperatures for each refrigeration compartment. Provide clear dial thermometers mounted flush with each

compartment reading in both Fahrenheit and Centigrade.

- I. Control and thermostat wiring is the responsibility of the Contractor, not the electrical contractor. The electrical contractor will provide inter-wiring between the freezer condensing units and freezer blower coils as well as the main power to all disconnect on condensing units and racks.
- J. All refrigeration parts, equipment and labor are the responsibility of the Contractor whether subcontracted or not. All refrigeration sleeves, lines, placements, hangers, insulations, connections and refrigerants are considered parts and must be made available to complete and deliver a fully installed system in working operation at the required temperatures.

### **2.13 EXHAUST HOODS**

- A. All exhaust hoods shall be constructed of stainless steel no less than 18-gauge, type 304. All exposed surfaces shall be a number 4 finish. See plans for size and location of ducts.
- B. All exposed hoods shall be (UL) Underwriter's Listed under the category "Exhaust Hood with Damper", listed with NSF (National Sanitation Foundation), and in accordance with all recommendations of NFPA's Standard #96.
- C. Provide stainless steel enclosure panels to finished ceiling, adjacent walls, and spaces between hoods.
- D. Light fixtures to be incandescent unless otherwise specified.
- E. Bottom of hood to be mounted at 80" above the finished floor.

### **2.14 FIRE SUPPRESSION SYSTEM**

- A. The fire suppression system shall conform to NFPA latest edition.
- B. Provide all surface appliance, hood, and duct protection nozzles.
- C. All exposed piping to be chrome plated or sleeved. Run unexposed wherever possible.
- D. Provide manual pull station. See plans for location.
- E. Provide mechanical gas shut-off valve for equipment below hoods.
- F. Provide testing of the system by the enforcing agency after installation is complete.
- G. The fire suppression system is to be built-into the exhaust hood by the hood manufacturer.

### **2.15 ENCLOSURES**

- A. Provide and install enclosure panels secured or removable for any equipment that houses any equipment with movable parts for access. Also, cover and provide protection for any exposed steam line or condensate line that may be within reach of operating personnel.

### **2.16 ELECTRICAL WORK - GENERAL REQUIREMENTS**

- A. Before ordering equipment confirm with the serving electric utility, all pertinent electrical requirement such as actual voltages available, number of phases and number of wires in the system.

### **2.17 INSERT PANS**

- A. All cut-outs, openings, drawers, or equipment specified or detailed to hold stainless steel insert pans shall be provided with a full complement of pans as follows:
  - 1. One stainless steel, 20-gauge minimum solid insert pan for each space, sized per plans, details, or specifications.
  - 2. Where pan sizes are not indicated in plans, details, or specifications, provide one full size

- pan for each opening.
- 3. Provide maximum depth pan to suit application and space.
- 4. Provide 18-gauge removable stainless steel adapter bars where applicable.

## **2.18 CORDS AND PLUGS**

- A. Where cords and plugs are used, they shall comply with National Electrical Manufacturer's Association (NEMA) requirements.

## **2.19 WATER FILTERS**

- A. Provide filters on all icemakers, beverage equipment, and steamers.

## **PART 3 EXECUTION**

### **3.01 DELIVERY, STORAGE, AND HANDLING**

- A. No provisions are normally made for receipt or storage of any item delivered to the job site before commencement of installation. Contractor is solely responsible for the staging, delivery and safe-keeping of all equipment until turned over to the owner.
- B. Fabricated and commercially manufactured equipment (buy-outs) must be received and accounted for by the Contractor at his warehouse facilities until such time as placement is possible and acceptable by the G.C.
- C. Clearly identify all items by item number and area prior to delivery to the job site.
- D. Under no circumstances shall any individual or agent of the owner, architectural trades, maintenance or security companies be asked to sign for or receive goods, equipment, or services on the job site. Items, parts, optional pieces, trim, or any goods provided under this contract are the responsibility of the contractor whether on the owner's property or in transit until the areas shown in these documents are handed over to the owner or owner's agents.

### **3.02 INSTALLATION**

- A. Contractor shall supervise and direct his work using his best skill and attention. During the installation period, the Contractor shall provide a competent superintendent or foreman for such directions regarding connection, installation, and coordination of all work under the contract.
- B. Installation shall be in strict conformance with referenced standards, the manufacturer's written directions, as shown on the drawings and herein specified. Kitchen equipment shall be installed per the "Guidelines for Seismic Restraints of Kitchen Equipment" by Sheet Metal and Air Conditioning Contractors National Association (SMACNA).
- C. Contractor shall be solely responsible for all construction means, methods, techniques, procedures and coordination of all portions his work under the contract and for coordinating the installations with the General Contractor, so as not to interfere with or delay the overall construction of the project.
- D. Contractor shall verify conditions at the building, particularly door openings, passages, and availability and size of elevators and avoid building any items too large for available openings. Contractor shall provide for the possible necessity of removing and replacing windows or wall panels. Any pieces too bulky for existing facilities shall be hoisted or otherwise handled with apparatus as required. All special handling equipment charges shall be paid by the Contractor.
- E. Floor troughs and drip pans shall be provided by Contractor and installed by the General

Contractor. The Contractor shall provide a supervisor for the installation.

- F. Accurately set, scribe, square, level and permanently secure all items in precise position as indicated on drawings and shop drawings. Exercise extreme care to avoid damaging finished surfaces during the handling and erecting of all items. Repair, replace or otherwise make good all damaged surfaces or blemishes arising from installation in a manner approved by the Owner.
- G. Complete installation with required fastenings, clip angles, braces, anchors and other fittings as required to render the work rigid and secure. Secure wood items with screws or anchor to furring strips to permit removal.
- H. Caulk all items resting on concrete pads to eliminate crevices between item and pad.
- I. Shim level items without legs with stainless steel shims. Caulk watertight to eliminate crevices between item and mounting surfaces on floor.
- J. Seal spaces between all units and walls, ceilings, floor or fixed adjoining units against entrance of food particles or vermin by means of trim strips, welding, soldering, or commercial joint material as suited to the nature of the equipment. Seal and smooth (when not exposed to extreme heat) with General Electric Silicone Construction Sealant Series SE1200 in appropriate color. Width of joints sealed with silicone not to exceed ¼"
- K. Contractor shall do all cutting and fitting on the equipment required by other contractors for access for the piping, conduit, or utility access.
- L. Do not use any exposed bolts, nuts, or screws other than those shown on shop drawings. Any additional and approved bolts, nut, or screws must be stainless steel.
- M. Protect equipment that has been delivered to the job site from damage. Counter and table tops to be covered with plywood, flakeboard or hardboard during the installation period.
- N. Upon completion of installation, clean and polish all surfaces of each item with appropriate materials. At this time, prepare to account to the consultant and Owner for quantities, locations, and conditions of all items.
- O. Should any repairs be required due to the neglect of the other contractors, the repairs must be approved by owner before the work is performed. All extra charges must be approved and all repairs required must be noted in writing before work is performed, stipulating the price and by whom the extra expense is to be paid. In case the Contractor does not secure such extra order, the expense shall be borne by him. No cutting, notching, drilling or altering of any kind shall be done to the building by the Contractor without first obtaining permission from the GC, Owner, or architect.
- P. Throughout the progress of the work, the Contractor shall keep the working area free from debris of all types, and remove from premises all rubbish resulting from any work being done by him. At the completion of work, the Contractor shall leave the premises in a clean and finished condition.

### **3.03 TRIMMING AND SEALING EQUIPMENT**

- A. Any space between units to walls, ceiling, floors, and adjoining units, not portable, shall be completely sealed against entrance of food particles or vermin by means of trim strips, welding soldering, or commercial joint material suitable to the nature of the equipment.
- B. Sealer, when not exposed to extreme heat, shall be silicone construction sealant in appropriate color.

- C. End of hollow sections shall be closed.
- D. Enclosed fixtures without legs mounted on masonry bases or floor shall be sealed watertight to base or floor.

#### **3.04 CUTTING AND FITTING**

- A. Provide cutting and fitting required on the equipment by subcontractors to make their work fit.
- B. Should any repairs to foodservice equipment be required due to neglect of other contractors, all extra charges and all anticipated repairs shall be noted in writing before work is performed. In case the Contractor does not follow this procedure, the expense shall be borne by him.
- C. No cutting, notching, drilling, or altering of any kind shall be done to the building without first obtaining permission.

#### **3.05 PROTECTION OF EQUIPMENT**

- A. Be responsible during the progress of the project to protect equipment against theft and/or damage until final acceptance by the Owner.
- B. Prefabricated walk-in boxes, on-site and installed in advance of the rest of the equipment, shall not be used for general storage by other trades and shall be locked before leaving the site. Damage and/or theft resulting from failure to secure boxes will be repaired/replaced at Contractor's expense.

#### **3.06 ADJUSTMENT OF EQUIPMENT AND DEMONSTRATION**

- A. Turn on all mechanical equipment, test for leaks, poor connections, inadequate or faulty performance and correct if necessary; adjust for proper operation.
  - 1. All thermostatically controlled equipment and equipment with automatic features shall be operated for a sufficient length of time to prove controls are functioning as intended.
- B. At a time and date, selected by the Owner, the Kitchen Equipment Contractor shall arrange for a demonstration of all mechanical equipment for the Owner's representatives. These demonstrations are to be conducted by factory trained representatives of the various equipment manufacturers and shall be done in two stages; one for the kitchen manager and staff and the second for the maintenance personnel. A representative of the Kitchen Equipment Contractor must attend all demonstrations.

**3.07 ITEMIZED LIST OF EQUIPMENT**

Abbreviations:

OFCI	Owner Furnished Contractor Installed
CFCI	Contractor Furnished Contractor Installed
OFOI	Owner Furnished Owner Installed

ITEM 1:	HAND SINK	QTY: 2	CFCI
---------	-----------	--------	------

- Manufacturer: Advance  
 Model: 7-PS-25
1. S/S hand sink with built-in soap dispenser.
  2. Towel dispensers by the district.

ITEM 2:	WALL SHELF	QTY: 7	CFCI
---------	------------	--------	------

- Manufacturer: Custom  
 Model: Custom
1. S/S wall shelves, size and shape per plan.
  2. See elevation drawings.

ITEM 3:	WORKTABLE WITH SINK	QTY: 1	CFCI
---------	---------------------	--------	------

- Manufacturer: Custom  
 Model: Custom
1. S/S worktable with sink, size and shape per plan, with splash at wall, with (2) 18" x 18" x 12" deep sink with center drain and lever waste assembly, s/s legs and partial undershelf.
  2. See elevations plans.

ITEM 4:	FAUCET	QTY: 4	CFCI
---------	--------	--------	------

- Manufacturer: T&S Brass  
 Model: B-0231
1. Splashmount faucet with 12" nozzle.
  2. Provide with B-0230-Kit installation kit.

ITEM 5:	S/S WORKTABLE	QTY: 1	CFCI
---------	---------------	--------	------

- Manufacturer: Custom  
 Model: Custom
1. S/S worktable, size and shape per plan, with splash at rear, s/s legs and undershelf.
  2. See elevation drawings.

ITEM 6:	WALL SHELF WITH UTENSIL RAIL	QTY: 1	CFCI
---------	------------------------------	--------	------

- Manufacturer: Custom  
 Model: Custom
1. S/S wall shelf, size and shape per plan, with s/s utensil rail with sliding hooks.
  2. See elevation drawings.



ITEM 7:	MIXER	QTY: 1	OFCI
Existing unit by owner - contractor installed.			

ITEM 8:	OVERSHELF	QTY: 2	CFCI
Manufacturer:	Custom		
Model:	Custom		
1. S/S overshelves, mounted to table below, size and shape per plan.			
2. See elevation drawings.			

ITEM 9:	SPARE NUMBER		
---------	--------------	--	--

ITEM 10:	MOP SINK CABINET	QTY: 1	CFCI
Manufacturer:	Eagle Group		
Model:	F1916-VSCS-DR		
1. S/S mop sink cabinet with mop sink in right cabinet, with faucet with 30" spray hose and spray hose bracket.			

ITEM 11:	WARMING CABINETS	QTY: 2	OFCI
Existing units by owner - contractor installed.			

ITEM 12:	INGREDIENT BINS	QTY: 2	OFOI
Existing units by owner - district installed.			

ITEM 13:	MAPLE TOP WORKTABLE	QTY: 1	OFCI
Existing unit by owner - contractor installed.			

ITEM 14:	S/S WORKTABLE	QTY: 1	CFCI
Manufacturer:	Custom		
Model:	Custom		
1. S/S worktable, size and shape per plan, with splash at rear, s/s legs and undershelf.			
2. See elevation drawings.			

ITEM 15:	FOOD PROCESSOR	QTY: 1	OFCI
Existing unit by owner - contractor installed.			

ITEM 16:	SHEET PAN RACKS	QTY: 2	OFOI
Existing units by owner - district installed.			

ITEM 17:	SPARE NUMBER		
----------	--------------	--	--

ITEM 18:	COMBI-OVEN - DOUBLE STACKED	QTY: 1	CFCI
----------	-----------------------------	--------	------

Manufacturer: Alto-Shaam  
 Model: CTC7-20G

1. Consists of two ovens, one stacked on top of the other.
2. 120 volt, nat. gas.
3. Provide with (2) model 5021522 installation kits.
4. Provide with (2) model 5016904 recessed door.
5. Provide with (2) containers (90 packets) CE-36354 cleaning tabs.
6. Provide with (2) cases CE-24750 spray cleaning liquid
7. Provide with (2) 4 lb. bottles delimiting product.
8. Provide with (2) model CR-33543 quick disconnect kits.
9. Provide with 5016707 stacking hardware.
10. Provide with 5017391 mobile stacking base.
11. Provide Combitherm Factory Authorized Installation for both ovens.

ITEM 19:	WATER FILTER SYSTEM	QTY: 1	CFCI
----------	---------------------	--------	------

Manufacturer: OptiPure  
 Model: 360/16 #164-14416

1. Water filter system for combi-ovens. One filter assembly per two ovens.
2. Provide with (1) CTO-Q replacement cartridge, (1) AMS-QT membrane replacement cartridge, and (1) MA-Q15 replacement cartridge.

ITEM 20:	EXHAUST HOOD	QTY: 1	CFCI
----------	--------------	--------	------

Manufacturer: Captive-Aire  
 Model: ND-2

1. S/S type I exhaust hood.
2. See hood plans, sheet K6.0, for details.

ITEM 21:	S/S WORKTABLE	QTY: 1	CFCI
----------	---------------	--------	------

Manufacturer: Custom  
 Model: Custom

1. S/S worktable, size and shape per plan, with splash at rear, s/s legs and undershelf.
2. See elevation drawings.

ITEM 22:	POT FILLER FAUCET	QTY: 1	CFCI
----------	-------------------	--------	------

Manufacturer: T&S Brass  
 Model: B-0592

1. Wall mount pot filler with 18" double jointed nozzle.

ITEM 23:	6-BURNER RANGE	QTY: 1	OFCI
----------	----------------	--------	------

Existing unit by owner - contractor installed.

ITEM 24:	DOUBLE STACK CONVECTION OVEN	QTY: 1	OFCI
Existing unit by owner - contractor installed.			

ITEM 25:	EXHAUST HOOD	QTY: 1	CFCI
Manufacturer:	Captive-Aire		
Model:	ND-2		
<ol style="list-style-type: none"> <li>S/S type I exhaust hood.</li> <li>See hood plans, sheet K6.0, for details.</li> </ol>			

ITEM 26:	DOUBLE STACK CONVECTION OVEN	QTY: 1	OFCI
Existing unit by owner - contractor installed.			

ITEM 27:	S/S WALL LINER/WALL CAP	QTY: 1	CFCI
Manufacturer:	Custom		
Model:	Custom		
<ol style="list-style-type: none"> <li>S/S flat wall liner under hood, to run from the bottom of the hood, full length of the hood wall and right end return wall, to the top of the coved floor base. To include s/s tile capping. To include s/s wall end caps.</li> </ol>			

ITEM 28:	EXHAUST SYSTEM CONTROL PANEL	QTY: 1	CFCI
Manufacturer:	Captive-Aire		
Model:	SC-DCV		
<ol style="list-style-type: none"> <li>Touch screen monitor.</li> <li>See hood plans for details.</li> </ol>			

ITEM 29:	UTILITY CARTS	QTY: 2	OFOI
Existing units by owner - district installed.			

ITEM 30:	FIRE SUPPRESSION PULL STATION	QTY: 1	CFCI
Manufacturer:	Captive-Aire		
Model:	Ansul R-102		
<ol style="list-style-type: none"> <li>Pull station - part of fire suppression system.</li> <li>See fire suppression plan.</li> </ol>			

ITEM 31:	FIRE SUPPRESSION SYSTEM	QTY: 1	CFCI
Manufacturer:	Captive-Aire		
Model:	Ansul R-102		
<ol style="list-style-type: none"> <li>See fire suppressions drawing, sheet K7.0.</li> <li>Coordinate with building alarm system and controls contractor.</li> </ol>			

ITEM 32:	S/S WORKTABLE	QTY: 1	CFCI
----------	---------------	--------	------

Manufacturer: Custom  
Model: Custom

1. S/S worktable, size and shape per plan, with splash at rear, s/s legs and undershelf.
2. See elevation drawings.

ITEM 33:	PREP TABLE WITH SINKS	QTY: 1	OFCI
----------	-----------------------	--------	------

Existing unit by owner - contractor installed.

ITEM 34:	AIR CURTAIN	QTY: 2	CFCI
----------	-------------	--------	------

Manufacturer: Berner  
Model: CLC08-1072A

1. Air curtain to be mounted above door.
2. White Finish.
3. 120 volt.
4. Provide with (4) 9503SD020-P automatic door switch, plunger type.

ITEM 35:	3-DOOR REFRIGERATOR	QTY: 1	CFCI
----------	---------------------	--------	------

Manufacturer: Traulsen  
Model: G30010

1. Three door reach-in refrigerator with solid s/s doors, hinging per floor plan, on HD casters.

ITEM 36:	ICE MACHINE AND BIN	QTY: 1	CFCI
----------	---------------------	--------	------

Manufacturer: Manitowoc  
Model: IDT1500A/D970

1. 1688 lbs production per 24 hours, dice size cubes.
2. Self-contained.
3. Provide with D970 bin with 882 lb ice capacity.

ITEM 37:	WATER FILTER ASSEMBLY	QTY: 1	CFCI
----------	-----------------------	--------	------

Manufacturer: Everpure  
Model: EV932422

1. Twin water filter for ice machine.

ITEM 38:	SPARE NUMBER		
----------	--------------	--	--

ITEM 39:	SPARE NUMBER		
----------	--------------	--	--

ITEM 40:	DRY STORAGE SHELVING	QTY: 1	OFCI
----------	----------------------	--------	------

Existing shelving by owner - contractor installed.

ITEM 41:	POT SINK	QTY: 1	CFCI
----------	----------	--------	------

Manufacturer: Custom  
 Model: Custom

1. S/S 4-tub pot sink, size and shape per plan, with (3) 20" x 28" x 12" deep sinks with center drains and lever waste assemblies, left sinks to accommodate garbage disposal, provide with s/s switch brackets, quick-drain assembly, splash at wall, s/s legs and rear cross bracing.
2. See elevations drawings.

ITEM 42:	GARBAGE DISPOSAL	QTY: 1	CFCI
----------	------------------	--------	------

Manufacturer: Insinkerator  
 Model: SS-200-7-RMS

1. Sink mount garbage disposal with #7 collar adaptor.
2. 2 HP, 208 volt.
3. Provide with dejamming wrench.

ITEM 43:	PRERINSE UNIT W/FAUCET	QTY: 2	CFCI
----------	------------------------	--------	------

Manufacturer: T&S Brass  
 Model: B-0133-ADF12-B

1. Splashmount prerinse unit with faucet with 12" nozzle.
2. Provide with B-0230-Kit installation kit.

ITEM 44:	DISHMACHINE	QTY: 1	CFCI
----------	-------------	--------	------

Manufacturer: Jackson WWS  
 Model: TEMPSTAR HH-3

1. High-temp dishmachine with high-hood with built-in 70 degree rise booster heater.
2. 208 volt, 3 phase.
3. Provide with pressure regulator.
4. Provide with flanged feet.
5. Provide with 5010-BP sheet pan rack.

ITEM 45:	EXHAUST HOOD	QTY: 1	CFCI
----------	--------------	--------	------

Manufacturer: Captive-Aire  
 Model: VHB-6

1. S/S type II exhaust hood for dishmachine.
2. See hood plans for details.

ITEM 46:	CLEAN DISHTABLE	QTY: 1	CFCI
----------	-----------------	--------	------

Manufacturer: Custom  
 Model: Custom

1. S/S clean side dishtable, size and shape per plan, with splash at rear, s/s legs and undershelf.
2. See elevations drawings.

ITEM 47:	SPARE NUMBER		
----------	--------------	--	--

ITEM 48:	SPARE NUMBER		
----------	--------------	--	--

ITEM 49:	WALK-IN COOLER/FREEZER	QTY: 1	CFCI
----------	------------------------	--------	------

Manufacturer: Duracold

Model: Custom

1. See sheets K8.0 and K8.1 for details.

ITEM 50:	WALK-IN SHELVING	QTY: 1 Lot	CFCI
----------	------------------	------------	------

Manufacturer: Metro

Model: Super Erecta - Metroseal 3

1. Dry storage shelving, quantity and sizes per plan.
2. Provide shelving units 63" high, with four shelves per unit.

ITEM 51:	EVAPORATIVE COIL - COOLER	QTY: 1	CFCI
----------	---------------------------	--------	------

Manufacturer: Russell

Model: RL6A117ADASL

1. Evap coil for walk-in cooler.
2. See refrigeration plans.

ITEM 52:	EVAPORATIVE COIL - FREEZER	QTY: 1	CFCI
----------	----------------------------	--------	------

Manufacturer: Russell

Model: RL6E077DDASL

1. Evap coil for walk-in freezer.
2. See refrigeration plans.

ITEM 53:	CONDENSING UNIT - COOLER	QTY: 1	CFCI
----------	--------------------------	--------	------

Manufacturer: Russell

Model: RFO150E4SDA

1. Condensing unit for walk-in cooler.
2. See refrigeration plans.

ITEM 54:	CONDENSING UNIT - FREEZER	QTY: 1	CFCI
----------	---------------------------	--------	------

Manufacturer: Russell

Model: RFO300L4SDA

1. Condensing unit for walk-in freezer.
2. See refrigeration plans.

ITEM S1:	SERVING COUNTER	QTY: 4	CFCI
----------	-----------------	--------	------

Manufacturer: Eagle Group  
Model: Custom

1. S/S serving counter per plans, with drop-in heated shelf, sneeze guard with food warmer in top.
2. Finish finishes to be advised.
3. Counter to be prewired and have one-point electrical connection for heated shelf and sneeze guard warmer.
4. Counter to have outlet for owner supplied refrigerator.

ITEM S2:	SNEEZE GUARD	QTY: 4	CFCI
----------	--------------	--------	------

Manufacturer: Eagle  
Model: Custom

1. Included in item S1

ITEM S3:	HOT FOOD SHELF	QTY: 4	CFCI
----------	----------------	--------	------

Manufacturer: Hatco  
Model: HBHG-4018

1. Included in item S1

ITEM S4:	REFRIGERATOR	QTY: 4	CFCI
----------	--------------	--------	------

Manufacturer: True  
Model: T-19G-HC FGD01

1. One door reach-in refrigerator with glass door, on castors.
2. Door hinged left.

ITEM S5:	WARMING CABINET	QTY: 2	OFCI
----------	-----------------	--------	------

Existing unit by owner – contractor installed.

ITEM S6:	REFRIGERATOR	QTY: 1	CFCI
----------	--------------	--------	------

Manufacturer: True  
Model: T-49G-HC FGD01

1. Two door reach-in refrigerator with glass door, on castors.
2. Standard door hinging.

ITEM S7:	HAND SINK	QTY: 1	CFCI
----------	-----------	--------	------

Manufacturer: Advance  
Model: 7-PS-25

1. S/S hand sink with built-in soap dispenser.
2. Towel dispenser by the district.

ITEM S8:	WARMING DRAWERS	QTY: 2	CFCI
----------	-----------------	--------	------

Manufacturer: Alto-Shaam

Model: 500-2D

1. Warming drawer unit with two drawers.
2. Provide with vented drawers.
3. Units to be mounted to shelf of serving counter.

ITEM S9:	SERVING COUNTER	QTY: 1	CFCI
----------	-----------------	--------	------

Manufacturer: Eagle Group

Model: Custom

1. S/S serving counter per plans.
2. With s/s pass-thru shelf. Coordinate with serving windows.
3. See Eagle drawings.

END OF SECTION



**SECTION 11 5200**  
**AUDIO-VISUAL EQUIPMENT**

**PART 1 GENERAL**

**1.01 SECTION INCLUDES**

- A. Television monitor mounting brackets
- B. Video Projector Mounting Brackets.

**1.02 RELATED SECTIONS**

- A. Section 01 6116 - Volatile Organic Compound (VOC) Content Restrictions.
- B. Section 06 1000 - Rough Carpentry.
- C. Section 09 2116 - Gypsum Wallboard.
- D. Division 26: Pertinent sections specifying electrical power connections and conduits/raceways for control systems.

**1.03 SUBMITTALS**

- A. See Section 01 3300 - Submittals, for submittal procedures.
- B. Product Data: Provide brochures, installation instructions.
- C. CAL-GREEN Submittals: Product Data – VOC Limits: For adhesives sealants, fillers, primers and coatings, documentation including printed statement of VOC contents, comply with limits specified in related section.
- D. Shop Drawings: Indicate in large scale detail, drawings of fabricated equipment showing construction methods, type and gage of metal, hardware and fittings, with plan and front elevation..
- E. Operation Data: Remote electric screens.
- F. Maintenance Data: Remote electric screens.
- G. Warranty: Submit manufacturer warranty and ensure that forms have been completed in Owner 's name and registered with manufacturer.

**1.04 DELIVERY, STORAGE, AND PROTECTION**

- A. Deliver products to site and store in enclosed areas protected from the weather.

**1.05 PROJECT CONDITIONS**

- A. Coordinate installation with size, location and installation of service utilities.
- B. Sequence installation to ensure utility connections are achieved in an orderly and expeditious manner.

**PART 2 PRODUCTS**

**2.01 PERFORMANCE REQUIREMENTS**

- A. VOC Limits for adhesives, sealants, fillers, primers and coatings . Comply with limits specified in related section.

## 2.02 TELEVISION MONITOR MOUNTING BRACKETS

- A. Wall Mounted, Articulating Arm Type for Flat Panel Displays.
  - 1. Accommodate flat panel displays 50 - 80 inches, 200 lb. capacity.
  - 2. Side-to-side leveling and vertical adjustment.
  - 3. Distance from wall adjustable 4- 27 inches off the wall.
  - 4. Cable Management devices.
  - 5. Security Fasteners.
  - 6. Recessed Low Voltage Media Plate with Duplex Surge Protector.
  - 7. Peerless Model SA763PU; [www.peerless-av.com](http://www.peerless-av.com).
- B. Manufacturers standard swivel and tilt mechanisms to allow unrestricted adjustment.
- C. All mounting hardware as required by manufacturers written installation instructions to suit wall construction conditions indicated.
- D. Finishes: Metal; black baked enamel or powder coating.
- E. Acceptable Manufacturers:
  - 1. Bretford, [www.bretford.com](http://www.bretford.com).
  - 2. Peerless Sales Company; Melrose Park, Illinois.
  - 3. Substitutions: See Section 01 6000 - Product Requirements.

## 2.03 VIDEO PROJECTOR MOUNTING BRACKETS

- A. Video Projector Mounts - General: Accommodate maximum dimensions overall 17"W x 27"D x 16"H. Projector; held in place by 14-gauge minimum steel arms; allow air flow and access to functions on all sides of the projector. Mount shall have roll, pitch and yaw adjustments to fine tune projector alignment. Hanger support system allows one-man installation, allowing projector mounting right-side up or upside down. Mount shall easily re-adjust for exchanging projectors. Finished in Black powder paint.
  - 1. Wall Mounted Yoke Type: Bretford, model \_\_\_\_\_ .
  - 2. Ceiling Mounted Suspended Type: . Provide with manufacturer standard 1-1/2 inch diameter black pipe and ceiling mounting brackets, rods and accessories required to suit applications indicated.
  - 3. Ceiling Mounted Flush Type: Bretford, model \_\_\_\_\_; Provide with manufacturer standard flush mount plate. Pitch is 10°, roll is 10° and yaw is 33° left and right off of projection line.

## 2.04 REMOTE CONTROL PROJECTION SCREENS

- A. Projection Screens: Electrically operated.
  - 1. Matte White viewing surface, flame retardant, mildew resistant.
  - 2. Ceiling mounted, standard case for exposed installation.
  - 3. Size: Viewing/Projection Area 10 feet - 6 inches high x 14 feet wide.
  - 4. "Extra Drop": Black, 36 inch.
  - 5. Pre-set adjustable limit switches for stopping picture surface.
  - 6. Key Switch: Manufacturer's standard type, with locking cover. Provide 6 keys per switch.
- B. Manufacturers:
  - 1. Da-Lite: Professional Electrol; [www.da-lite.com](http://www.da-lite.com).
  - 2. Draper, [www.draperinc.com](http://www.draperinc.com).
  - 3. Substitutions: See Section 01 6000 - Product Requirements.

### **PART 3 EXECUTION**

#### **3.01 EXAMINATION**

- A. Verify that ventilation outlets, service connections, and supports are correct and in scheduled location.
- B. Verify projector focal range prior to final location of projector mounts and/or projector screen. Obtain Owner's written acceptance of positioning for each condition prior to installation.
- C. Correct unsatisfactory conditions prior to beginning installation.
- D. Beginning of installation means acceptance of existing conditions.

#### **3.02 INSTALLATION**

- A. Install in accordance with manufacturer's instructions.
- B. Use anchoring devices provided or required by the manufacturer.

#### **3.03 INTERFACE WITH OTHER WORK**

- A. Television Monitor Brackets Coordinate wood framing and gypsumboard with installation of backing plates.
  - 1. Cut, fit and patch where necessary. Coordinate work with others.

#### **3.04 ADJUSTING**

- A. Clean and adjust equipment and apparatus to ensure proper working order and conditions.
- B. Adjust limit switches of motorized screens as appropriate for project conditions. Do not allow extended screens to touch floor.

#### **3.05 CLEANING**

- A. Remove masking or protective covering from finished surfaces. Wash and clean equipment
- B. Protect installed equipment from subsequent construction operations.
- C. Demonstrate proper operation at time of closeout. Deliver keys to Owner via Architect.

**END OF SECTION**

**SECTION 12 2100**  
**WINDOW SHADE SYSTEMS**

**PART 1 GENERAL**

**1.01 SECTION INCLUDES**

- A. Manually-operated window shades and accessories for sun/glare/heat control and room darkening.
- B. Motorized window shades and accessories for sun/glare/heat control and room darkening.

**1.02 RELATED SECTIONS**

- A. Section 06 1000: Rough Carpentry; blocking for support of window shades.
- B. Division 08: Pertinent sections specifying window, door and/or storefront opening systems.
- C. Division 09: Pertinent Sections specifying wall finishes adjacent to window shades.

**1.03 SUBMITTALS**

- A. See Section 01 3300 - Submittals, for submittal procedures.
- B. Product Data: Manufacturer's catalog data, product descriptions, installation instructions, detail sheets, and specifications for each type system specified.
- C. Samples for Selection: Manufacturer's color chart or sample sets;
  - 1. Color swatches for initial blind color selection from manufacturer's full range of available colors.
  - 2. Standard aluminum finish color samples from manufacturer's range of standard colors.
- D. Shop Drawings: Prepared specifically for this project; show dimensions and interface with other products.
  - 1. Interior Elevations at 3/8 inch = 1 foot scale minimum indicating shade layout, seam / batten locations and coordination with surrounding conditions.
  - 2. Floor plans or reflected ceiling plans showing overall arrangement of shades and control locations and mounting details and installation methods.
  - 3. Head, Jamb and sill details as necessary to coordinate work with surrounding conditions and construction.
  - 4. Room schedule including field-verified dimensions of each opening to receive window shade systems, coordinating room number, window type, shade fabric type and color, quantities and key to details.
  - 5. Indicate System Series, operator, fabric selection, and mounting type.
  - 6. Selection Samples: For each finish product specified, two complete sets of shade cloth options and aluminum finish color samples representing manufacturer's full range of available colors and patterns. or as indicated on the drawings.
  - 7. Indicate control type.
- E. Manufacturer's standard installation instructions.
- F. Design Data, Test Reports, Certificates: Current reports from independent testing laboratories demonstrating compliance with specified criteria.
- G. Extra Materials:
  - 1. Provide additional 5% of the total length of qualified stainless steel chain required on the project, not to exceed the quantity of one 500' spool.
  - 2. Provide additional 5% of each type of shade mounting hardware or brackets, but not less than one pair of each type.

3. Provide a quantity of replacement shadebands completely fabricated and ready to attach to roller tubes equal to 5% of the total number of shadebands of each fabric and each color in the largest size required for each of those fabrics.
4. Clearly label all spare components and supply to Owner upon completion in original packaging for storage on site by Owner.
5. Maintenance Service: Provide a separate proposal to the Owner for the cost for annual maintenance contract providing service 'on demand' for repair and maintenance as may be generally anticipated for the conditions of this project.

#### **1.04 QUALITY ASSURANCE**

- A. Manufacturer: 20 years minimum experience manufacturing products comparable to those specified in this section.
- B. Installer: Approved by manufacturer. 5 years minimum experience installing products comparable to those specified in this section.
- C. Fire Resistance: Provide shade fabrics tested in accordance with:
  1. NFPA 701 Standard Methods of Fire Tests for Flame Propagation of Textiles and Films
  2. 1996 NFPA 701 small scale Vertical Burn (telephone booth test) and rated "PASS."
- D. Toxicity: Provide shade fabrics tested in accordance with University of Pittsburgh Toxicity Protocol including LC50 analysis and toxicity characteristics.
- E. Anti-microbial: ASTM G-22-80 results for ATCC6538 (*Staphylococcus aureus*) and ATCC13388 (*Pseudomonas aeruginosa*) indicating minimum 5mm (0.197 inches) 'No Growth Contact Area'.
  1. ASTM G-21-85 results for ATCC9642, ATCC9644, ATCC9348 and ATCC9645 indicating 'No Growth'.
- F. Electrical: Control systems and components approved AS A SYSTEM by either Underwriter Laboratories (UL) or Electronic Testing Laboratories (ETL).
- G. Do not fabricate shades without obtaining field dimensions for each opening. Coordinate construction of surrounding conditions to allow for timely field dimension verification.

#### **1.05 DELIVERY, STORAGE, AND HANDLING**

- A. Deliver products to project site in manufacturer's original cartons.
- B. Individually package and mark shades with room number and opening number.
- C. Inspect the materials upon delivery to assure that specified products have been received.
- D. Store and handle shades to prevent damage to fabrics, finishes, and operators prior to installation.
- E. Do not deliver items to the project until all concrete, masonry, plaster, painting and other wet work has been completed and dry.

#### **1.06 WARRANTY**

- A. Shade Motors and motor control system electrical components: Provide Manufacturer's warranty under provisions of Division 01 - General Requirements. Warranty period to be 5 years from Date of Substantial Completion for shade motors and two years for all other control components containing provisions that installation will remain operational without fault for the warranty period and include all operating parts.
- B. Shadecloth and all other components of shade system are warranted to be fit for the use intended for a minimum of 10 years.

- C. Installation: Provide Contractor's warranty under provisions of Division 01 - General Requirements that installation shall be free from defects for a period of not less than 1 year.
- D. In the event of a warranted product failure, the Shade Contractor will, at no cost to owner, facilitate acquisition and delivery of all necessary components to the owner.

## **PART 2 PRODUCTS**

### **2.01 MANUFACTURERS**

- A. MechoShade Systems Inc.: [www.mechoshade.com](http://www.mechoshade.com).
- B. Substitutions: See Section 01 6000 - Product Requirements.
- C. Provide all window shade systems from a single manufacturer.

### **2.02 ROLLER SHADE ASSEMBLIES**

- A. Shadebands: Construction of shadeband includes the fabric, the hembar and hempocket, and the attachment of the shadeband to the roller tube:
  - 1. Vinyl Room darkening Shadecloth (single-fabric): MechoShade Systems, Inc., "0700 Series", Blackout material, washable and colorfast laminated and embossed vinyl coated fabric, 0.012 inches thick (.30 mm) blackout material and weighing 0.81 lbs. per square yard, with a minimum of 62 threads per square inch in colors selected from manufacturer's available range.
  - 2. Exposed (Blackout) Hembar: 3/8 x 1-1/2 inches with vinyl seal and concealed attachment to shadecloth. Bevel top and bottom of hembar to smoothly travel up and down inside side channels. Extend shadeband and hembar into side channel as a single element where side channels are required.
- B. Shade Hardware and Shade Brackets:
  - 1. Provide shade hardware constructed of minimum 1/8" thick (3.175 mm) cadmium plated steel or thicker as required to support 150% of the full weight of each shade.
  - 2. Allow for removal of shade roller tube from brackets without removing hardware from opening or without requiring end or center support brackets to be removed.
  - 3. Allow for removal and re-mounting of the shade bands without having to remove the shade tube, drive or operating support brackets.
  - 4. Allow for field adjustment of motor or replacement of any operable hardware component without requiring removal of brackets regardless of mounting position (inside or outside mount).
  - 5. Allow for removable regular roll fascia(s) to be mounted continuously across two or more shades without requiring exposed fasteners.
  - 6. Allow for operation of multiple shadebands offset by a maximum of (12) (45) from the motor axis between shadebands, (6) (22.5) on each side of the radial line, by a single motor (Multi-banded shades) subject to manufacturer's design criteria.
  - 7. Provide positive mechanical engagement of drive mechanism to shade roller tube. Friction fit connections for drive mechanism to shade roller tube shall not be acceptable.
  - 8. Use only Delrin engineered plastics by DuPont for all plastic components of shade hardware. Styrene based plastics are not acceptable: polyester or reinforced polyester shall not be acceptable.
  - 9. Shade roller and shadecloth attachment:
  - 10. Use extruded aluminum shade roller tube of diameter and wall thickness required to support shade fabric without (excessive) deflection. Roller tubes less than 2.55 inches (65 mm) in diameter are not acceptable.
  - 11. Provide for positive mechanical engagement with drive / brake mechanism.
  - 12. Provide for positive mechanical attachment of shadeband without requiring use of adhesives, adhesive tape, staples or rivets. Two sided pressure sensitive adhesive tape is not acceptable, shade bands stapled to roller tube shall not be acceptable.

13. Attach shadebands to tube such that removal and replacement of a shadeband can be accomplished without removing either the tube from the brackets or without removing shade brackets or the drive operator. Shadebands must be replaceable on site.
- C. Shade Motors and Motor Control System [IQ/MLC System]: [Hard-wired system]
1. Shade Motors:
    - a. Tubular, asynchronous (non-synchronous) motors with built-in reversible capacitor operating at 110V AC (60hz), single phase, temperature Class A, thermally protected, totally enclosed, maintenance free with line voltage power supply equipped with locking disconnect plug assembly furnished with each motor.
    - b. Conceal shade motors inside shade roller tube.
    - c. Each shade motor draws a maximum current of 2.3 amps.
    - d. Use motors rated at the same nominal speed for all shades in the same room.
    - e. Total hanging weight of shadeband shall not exceed 80% of the rated lifting capacity of the shade motor and tube assembly.
  2. Wall Switches: 3 button architectural flush mounted switches with metal cover plates and no exposed fasteners.
    - a. Connect local wall switches to control system components via low voltage (12V DC) 4 conductor modular cable equipped with RJ-11 type connectors supplied, installed and certified under Section 16 0000.
    - b. Connect master wall switches to control system components via low voltage (12V DC) 6 conductor modular cable equipped with RJ-12 type connectors supplied, installed and certified under Section 16000.
  3. Motor Control System:
    - a. Shade Motors and Control System [Intelligent Motor Control System]: (Software, two way communication). Specifications and Design are based on the IMC motor control system as manufactured by MechoShade Systems, Inc. Other systems may be acceptable provided that all of the following performance capabilities are provided. Motor control systems not in complete compliance with these performance criteria shall not be accepted AS EQUAL TO OR EQUIVALENT SYSTEMS.
    - b. Provide power to each shade motor via individual 3 conductor line voltage circuits connecting each motor to the relay based Intelligent controllers (IQ/MLC).
    - c. Control system components provide appropriate (spike and brown out) over-current protection (+/- 10% of line voltage) for each of the four individual motor circuits and shall be rated by UL or ETL as a recognized component of this system and tested as an integrated system.
    - d. Motor control system allows each group of four shade motors in any combination to be controlled by each of four local switch ports, with up to fourteen possible "sub-group" combinations via local 3 button wall switches and all at once via a master 3 button switch. System shall allow for overlapping switch combinations from 2 or more local switches.
    - e. Multiple "sub-groups" from different IQ/MLC control components may be combined to form "groups" operated by a single 3 button wall switch, from either the master port or in series from a local switch port.
    - f. Each shade motor shall be accessible (for control purposes) from up to four local switches and one master switch.
    - g. Control system shall allow for automatic alignment of shade hembars at 25%, 50% and 75% of opening heights, or up to three user defined intermediate stopping positions in addition to all up / all down positions regardless of shade height, a total of 5 positions. Control system shall allow shades to be stopped at any point in the opening height, however, shade hembars may not be in alignment at these non-defined positions.

- h. Control system shall have two standard operating modes: Normal Mode allowing the shades to be stopped anywhere in the window's opening height and Uniform Mode allowing the shades to only be stopped at the predefined intermediate stop positions. Both modes shall allow for all up/all down positioning.
  - i. Control system components shall allow for interface with low voltage Audio Visual system components via a dry contact terminal block.
  - j. Control system components shall allow for interface with external analog input control devices such as solar activated controllers, wind activated controllers, 24 hour timers, etc. via a dry contact terminal block.
  - k. Reconfiguration of switchable groups [as specified above] shall not require rewiring of the hardwired line voltage motor power supply wiring or the low voltage control wiring. Reconfiguration of switch groups shall be accomplished within the motor control device (IQ/MLC).
- D. Regular Roll Fascia:
- 1. Continuous removable extruded aluminum fascia (Architect to select color from manufacturer's standards) that attaches to shade mounting brackets without the use of adhesives, magnetic strips or exposed fasteners.
  - 2. Fascia shall be able to be installed across two or more shadebands in one piece.
  - 3. Fully conceal brackets, shade roller and fabric on the tube.
  - 4. Chain drive shall fall behind the bottom return edge of the fascia without requiring notching of the fascia.

## 2.03 FABRICS

- A. Fabric for Sun/Glare/Heat Control: Style 3000; PVC coated fiberglass and polyester weave, 14 percent open; 14.6 ounces per square yard (495 g/square m), 0.027 inch (0.69 mm) thick; meet or exceed California flame tests.
  - 1. Color: As indicated on drawings.
- B. Fabric for Room Darkening: Blackout; Spinnaker 4-ply, 12 mil (0.305 mm) laminated fiberglass room darkening fabric; washable, flame retardant, white color outside.
  - 1. Color: As selected from manufacturers standards.

## 2.04 FABRICATION

- A. Fabricate units to completely fill existing openings from head to sill and jamb to jamb, unless specifically indicated otherwise. Comply with Manufacturer's edge clearance standards and recommendations.
- B. Fabricate shadecloth to hang flat without buckling or distortion. Fabricate with heat-sealed trimmed edges to hang straight without curling or raveling. Fabricate unguided shadecloth to roll true and straight without shifting sideways more than 1/8 inch in either direction per 8 feet of shade height due to warp distortion or weave design.
- C. Provide battens in non-railroaded shades as required the by Manufacturer to assure proper tracking and uniform rolling of the shadebands, in accordance with the manufacturer's published width x height fabricate guide and standards.
- D. Weighted batten bars: At locations recommended by manufacturer.
- E. For railroaded shadebands, provide seams or battens in railroaded multi-width shadebands as required by Manufacturer to meet Width:Height ratios and size requirements.
- F. Provide batten pockets utilizing self-colored fabric front and back, RF welded into the shadecloth.
- G. Provide a self-colored opaque liner front and back to eliminate any see through of the batten pocket and shall not exceed 1-1/2 inches (38 mm) high and be totally opaque. A see-through



moiré effect which occurs with multiple layers of transparent fabrics is not acceptable. Reinforce batten pockets using coil coated, roll formed spring steel to insure flatness of shadebands in accordance with manufacturer's standards. Concave formed profile of batten stiffeners to be compatible with diameter of shade roller tube.

## **2.05 FINISHES**

- A. Aluminum Components: Architect shall select from Manufacturer's standard PPG Duracron baked enamel colors.
- B. Steel Components: Cadmium-plated, satin-finished, or bonderized prior to painting with Manufacturer's standard baked-enamel finish.

## **PART 3 EXECUTION**

### **3.01 EXAMINATION**

- A. Examine substrate and conditions for installation. Do not commence installation until conditions are satisfactory. Commencement of installation indicates acceptance of site conditions by Contractor.
- B. Verify that utilities and control conduits are of the correct types and in correct locations.

### **3.02 INSTALLATION**

- A. Install window shade systems in accordance with manufacturer's instructions and these specifications. Install units to comply with the Manufacturer's instructions for the type of mounting and operation required. Provide units plumb, true, and securely anchored in place with recommended hardware and accessories to provide smooth operation without binding.
- B. Assume responsibility for all field dimensions and mounting surfaces.
- C. Adjust window shade systems for proper operation.
- D. Tolerances:
  - 1. Maximum variation of gap at window opening perimeter: 1/4 inch, per 8 feet (+/- 1/8 inch) of shade height (6.35 mm per 2438 mm +/- 3.2 mm).
  - 2. Maximum offset from level: 1/16 inch per 5 feet of shade width (1.587 per 1524 mm of shade width).

### **3.03 ADJUST AND CLEAN**

- A. Adjust drive / brake mechanism of units for smooth operation. Adjust shade and shadecloth to hang flat without buckling or distortion. Replace any units or components which do not hang properly or operate smoothly.
- B. Touch up damaged finishes and repair minor damage in order to eliminate evidence of repair. Remove and replace work that cannot be satisfactorily repaired.
- C. Clean exposed surfaces, including metal and shadecloth, using non-abrasive materials and methods recommended by the Shadecloth Manufacturer. Remove and replace work which cannot be satisfactorily cleaned

### **3.04 DEMONSTRATION**

- A. Demonstrate operation method and instruct Owner's personnel in the proper operation and maintenance of the window shade systems.

**END OF SECTION**

**SECTION 12 3600  
COUNTERTOPS**

**PART 1 GENERAL**

**1.01 SECTION INCLUDES**

- A. Countertops for architectural cabinet work.
- B. Solid surfacing countertops

**1.02 RELATED REQUIREMENTS**

- A. Section 01 6116 - Volatile Organic Compound (VOC) Content Restrictions.
- B. Section 01 8113 - Sustainable Design Requirements.
- C. Section 06 4100 - Architectural Wood Casework
- D. Pertinent sections of other divisions specifying work penetrating countertops.
- E. Pertinent sections of other divisions specifying assembly, installation, and connection of plumbing work, plumbing elements penetrating countertops or splashes.
- F. Pertinent sections of other divisions specifying assembly, installation, and connection of electrical work, electrical elements penetrating countertops or splashes.

**1.03 REFERENCE STANDARDS**

- A. ANSI A208.1 - American National Standard for Particleboard; 2009.
- B. ANSI A208.2 - American National Standard for Medium Density Fiberboard for Interior Use; 2009.
- C. ASTM A666 - Standard Specification for Annealed or Cold-Worked Austenitic Stainless Steel Sheet, Strip, Plate, and Flat Bar; 2015.
- D. ASTM E84 - Standard Test Method for Surface Burning Characteristics of Building Materials; 2015a.
- E. AWI/AWMAC/WI (AWS) - Architectural Woodwork Standards; 2014.
- F. AWMAC/WI (NAAWS) - North American Architectural Woodwork Standards, U.S. Version 3.0; 2016.
- G. California Code of Regulations, Title 24, Part 2, California Building Code (CBC), International Building Code.
- H. California Code of Regulations, Title 24, Part 11 California Green Building Standards Code, "CAL-Green".
- I. NEMA LD 3 - High-Pressure Decorative Laminates; 2005.
- J. PS 1 - Structural Plywood; 2009.
- K. WI (CCP) - Certified Compliance Program (CCP); current edition at [www.woodworkinstitute.com/certification](http://www.woodworkinstitute.com/certification).
- L. AWI/AWMAC/WI - Architectural Woodwork Standards (AWS)

**1.04 SUBMITTALS**

- A. See Section 01 3300 - Submittals, for submittal procedures.

- B. Provide complete submittals at the same time as submittals for work in related sections to permit review of complete and integrated systems and assemblies.
- C. Product Data: Demonstrate compliance with specified attributes, provide Manufacturer's data sheets on each product to be used, including:
  - 1. Preparation instructions and recommendations.
  - 2. Storage and handling requirements and recommendations.
  - 3. Specimen warranty.
- D. CAL-GREEN Submittals:
  - 1. Product Data - VOC Limits: For adhesives, sealants, fillers, primers and coatings, documentation including printed statement of VOC contents, comply with limits specified in related section.
  - 2. Composite Wood Formaldehyde Limits: Provide certification that all products meet current CARB Airborne Toxic Control Measure (ATCM) for Composite Wood Formaldehyde Limits by Mandatory Compliance Dates as specified in related section.
- E. Shop Drawings: Complete details of materials and installation; combine with shop drawings of cabinets and casework specified in other sections.
- F. Selection Samples: For each finish product specified, color chips representing manufacturer's full range of available colors and patterns.
- G. Verification Samples: For each finish product specified, minimum size 6 inches (150 mm) square, representing actual product, color, and patterns.
- H. Test Reports: Chemical resistance testing, showing compliance with specified requirements.
- I. Certificate: Submit labels and certificates required by quality assurance and quality control programs.
- J. Installation Instructions: Manufacturer's installation instructions and recommendations.
- K. Maintenance Data: Manufacturer's instructions and recommendations for maintenance and repair of countertop surfaces.

#### **1.05 QUALITY ASSURANCE**

- A. Installer Qualifications: Fabricator.
- B. Quality Certification:
  - 1. Provide labels or certificates indicating that the installed work complies with AWI/AWMAC/WI (AWS) or AWMAC/WI (NAAWS) requirements for grade or grades specified.
  - 2. Provide designated labels on shop drawings as required by certification program.
  - 3. Provide designated labels on installed products as required by certification program.
  - 4. Submit certifications upon completion of installation that verifies this work is in compliance with specified requirements.
  - 5. Arrange and pay for inspections required for certification.
  - 6. Replace, repair, or rework all work for which certification is refused.

#### **1.06 DELIVERY, STORAGE, AND HANDLING**

- A. Store products in manufacturer's unopened packaging until ready for installation.
- B. Store and dispose of solvent-based materials, and materials used with solvent-based materials, in accordance with requirements of local authorities having jurisdiction.

## 1.07 FIELD CONDITIONS

- A. Maintain environmental conditions (temperature, humidity, and ventilation) within limits recommended by manufacturer for optimum results. Do not install products under environmental conditions outside manufacturer's absolute limits.

## PART 2 PRODUCTS

### 2.01 PERFORMANCE REQUIREMENTS

- A. VOC Limits for adhesives, sealants, fillers, primers and coatings . Comply with limits specified in related section.
- B. Composite Wood products must meet current CARB Airborne Toxic Control Measure (ATCM) for Composite Wood Formaldehyde Limits by Mandatory Compliance Dates as specified in Section 01 6116.

### 2.02 COUNTERTOPS

- A. Plastic Laminate Countertops: High-pressure decorative laminate (HPDL) sheet bonded to substrate.
  - 1. Laminate Sheet: NEMA LD 3, Grade HGS, 0.048 inch (1.2 mm) nominal thickness.
    - a. Surface Burning Characteristics: Flame spread index of 25, maximum; smoke developed index of 450, maximum; when tested in accordance with ASTM E84.
    - b. NSF approved for food contact.
    - c. Wear Resistance: In addition to specified grade, comply with NEMA LD 3 High Wear Grade requirements for wear resistance.
    - d. Finish: Matte or suede, gloss rating of 5 to 20.
    - e. Manufacturers: Selected from those listed in Section 06 4100. Provide all materials from a single manufacturer.
  - 2. Exposed Edge Treatment: Square, substrate built up to minimum 1-1/4 inch (32 mm) thick; covered with matching laminate.
  - 3. Back and End Splashes: Same material, same construction.
- B. Solid Surfacing - Recycled Plastic Countertops: Solid surfacing sheet of polyester resin casting over continuous substrate, containing post-consumer plastic waste.
  - 1. Flat Sheet Thickness: 1/2 inch (12 mm), minimum.
  - 2. Solid Surfacing Sheet and Plastic Resin Castings: Composed of polyester resin, mineral filler, and pigments; homogenous, non-porous and capable of being worked and repaired using standard woodworking tools; no surface coating; color and pattern consistent throughout thickness.
  - 3. Color: As selected by Architect, minimum 200 choices.
  - 4. Approximate Weight (12mm Thick): 18.3 Kg / M<sup>2</sup>
  - 5. Density ASTM D792a: 1,41 ± 0,01 G/Cm<sup>3</sup>
  - 6. Flexural Strength, ASTM D 790: 36,3 ± 2,6 Mpa
  - 7. Modulus Of Elasticity (Flexural) ASTM D 790: 4810 ± 50 Mpa
  - 8. Tensile Strength, ASTM D 638: 16,1 ± 3,1 Mpa
  - 9. Modulus Of Elasticity (Tensile) ASTM D 638: 4780 ± 260 Mpa
  - 10. Elongation At Break: ASTM D 638 0,3 ± 0,1 %.
  - 11. Impact Resistance(Charpy): Iso 179 1,7 ± 0,5 Kj /M<sup>2</sup>
  - 12. Barcol Hardness: ASTM D2583 46 ± 2.
  - 13. Linear Thermal Expansion (Coefficient) ASTM D 696: 72 X 10<sup>-6</sup> (0,0072 % / °C)
  - 14. Manufacturers:
    - a. Durat Solid Surface; [www.durat.com](http://www.durat.com).
    - b. Substitutions: See Section 01 6000 - Product Requirements.
    - c. Color and Pattern: As indicated on drawings.
  - 15. Other Components Thickness: 1/2 inch (12 mm), minimum.

16. Back and End Splashes: Same sheet material, square top; minimum 4 inches (102 mm) high.
- C. Stainless Steel Countertops: ASTM A666, Type 304, stainless steel sheet; 16 gage, 0.0625 inch (1.59 mm) nominal sheet thickness.
  1. Finish: 4B satin brushed finish.
  2. Exposed Edge Shape: Bullnose with return; 5/8 inch (16 mm) radius, return to face of case; reinforced with hardwood or steel.
  3. Back and End Splashes: Same material; welded 1/4 inch (6 mm) radius coved joint to countertop; square top edge with 1 inch (25 mm) wide top surface and minimum 1/2 inch (12 mm) turndown.
  4. Splash Dimensions: 4 inch (100 mm) high by 1 inch (25 mm) thick, unless otherwise indicated.
  5. Sinks: Same material, same thickness; flush welded to counter; bottom sloped to outlet; radiused interior corners; drain outlet located in back corner.
  6. Associated Window Sills: Same material, same thickness.

### 2.03 MATERIALS

- A. Wood-Based Components:
  1. Wood fabricated from old growth timber is not permitted.
- B. Plywood for Supporting Substrate: PS 1 Exterior Grade, A-C veneer grade, minimum 5-ply; minimum 3/4 inch (19 mm) thick; join lengths using metal splines.
- C. Particleboard for Supporting Substrate: ANSI A208.1 Grade 2-M-2, 45 pcf (20 kg/cu m) minimum density; minimum 3/4 inch (19 mm) thick; join lengths using metal splines.
- D. Medium Density Fiberboard for Supporting Substrate: ANSI A208.2.
  1. Type specified in Section 06 4100.
- E. Adhesives: Chemical resistant waterproof adhesive as recommended by manufacturer of materials being joined.
- F. Countertop Support Brackets: Provide at locations where countertop span is not supported by base cabinet, maximum 36 inches on center.
  1. Steel, welded construction, powder coat finish, color selected by Architect.
  2. Support Arms: Match countertop depth, 2 inch flanges, extended concealed arm predrilled for bolting to wall studs or other support.
  3. A&M Hardware, Inc. 2.0 inch Concealed Brackets: [www.AandMhardware.com](http://www.AandMhardware.com).
  4. Substitutions: See Section 01 6000 - Product Requirements.
- G. Joint Sealant: Mildew-resistant silicone sealant, color-matched to countertop, clear at stainless steel.

### 2.04 FABRICATION

- A. Fabricate in accordance with standards governing fabrication quality that are specified in Section 06 4100.
- B. Fabricate tops and splashes in the largest sections practicable, with top surface of joints flush.
  1. Join lengths of tops using best method recommended by manufacturer.
  2. Fabricate to overhang fronts and ends of cabinets 1 inch (25 mm) except where top butts against cabinet or wall.
  3. Prepare all cutouts accurately to size; replace tops having improperly dimensioned or unnecessary cutouts or fixture holes.
  4. Locate openings accurately and use templates or roughing-in diagrams to provide accurate size and shape.

5. Smooth edges of cutoffs and, where located in countertops and similar exposures, seal edges of cutouts with a water resistant coating.
- C. Provide back/end splash wherever counter edge abuts vertical surface unless otherwise indicated.
  1. Secure to countertop with concealed fasteners and with contact surfaces set in waterproof glue.
  2. Height: 4 inches (102 mm), unless otherwise indicated.
- D. Stainless Steel: Fabricate tops up to 144 inches (3657 mm) long in one piece including nosings and back and end splashes; accurately fitted mechanical field joints in lengths over that dimension are permitted.
  1. Weld joints; grind smooth and polish to match.
  2. Provide stainless steel hat channel stiffeners, welded or soldered to underside, where indicated on drawings.
  3. Provide wall clips for support of back/end splash turndowns.
  4. Sound Deadening: Apply water resistant, fire resistant sound deadening mastic to entire bottom surface.

### **PART 3 EXECUTION**

#### **3.01 EXAMINATION**

- A. Do not begin installation until substrates have been properly prepared.
- B. If substrate preparation is the responsibility of another installer, notify Architect of unsatisfactory preparation before proceeding.
- C. Verify that wall surfaces have been finished and mechanical and electrical services and outlets are installed in proper locations.

#### **3.02 PREPARATION**

- A. Clean surfaces thoroughly prior to installation.
- B. Prepare surfaces using the methods recommended by the manufacturer for achieving the best result for the substrate under the project conditions.

#### **3.03 INSTALLATION**

- A. Install concealed support brackets before wall finishes are applied. Install at spacings indicated on Drawings, except if none are shown, install at maximum 36 inches on center.
- B. Securely attach countertops to cabinets or concealed brackets using concealed fasteners. Make flat surfaces level; shim where required.
- C. Attach plastic laminate countertops using screws with minimum penetration into substrate board of 5/8 inch (16 mm).
- D. Attach stainless steel countertops using stainless steel fasteners and clips.
- E. Seal joint between back/end splashes and vertical surfaces.

#### **3.04 TOLERANCES**

- A. Variation From Horizontal: 1/8 inch in 10 feet (3 mm in 3 m), maximum.
- B. Offset From Wall, Countertops: 1/8 inch (3 mm) maximum; 1/16 inch (1.5 mm) minimum.
- C. Field Joints: 1/8 inch (3 mm) wide, maximum.

**3.05 CLEANING**

**3.06 PROTECTION**

- A. Protect installed products until completion of project.
- B. Touch-up, repair or replace damaged products before Date of Substantial Completion.

**END OF SECTION**

## SECTION 12 9300

### SITE FURNISHINGS

#### PART 1 GENERAL

##### 1.01 SUMMARY

- A. The General Conditions and all other Contract Documents for this project are complementary and applicable to this Section of the Specifications.
- B. Work Included: furnish all labor, materials, equipment and services necessary to provide and construct, repair or install the site elements, complete in place, as shown and specified, including, but not limited to:
  - 1. Bike Locker
  - 2. Bike Rack
  - 3. Flagpole
- C. Related Work
  - 1. 03 3000 Cast-In-Place Concrete

##### 1.02 SUBMITTALS

- A. Submit shop drawings to the District for approval before installing any manufactured items. Plans shall include dimensions, color, finish, structural design (custom items) and connection details.
- B. Submit shop drawings of other materials listed in this section to the District for approval before installation.
  - 1. Provide material samples, color samples, brushouts or charts for all items.

#### PART 2 PRODUCTS

##### 2.01 MANUFACTURED ITEMS

- A. Bike Locker
  - 1. Bike Locker shall be as specified on the Drawings or approved equal.
- B. Bike Rack
  - 2. Bike Rack shall be as specified on the Drawings or approved equal.
- C. Flagpole
  - 1. Flagpole shall be as specified on the Drawings or approved equal.

##### 2.02 MISCELLANEOUS MATERIALS

- A. All other materials for site elements shall be as specified on the Drawings and these specifications.

#### PART 3 EXECUTION

##### 3.01 INSTALLATION



- A. Examination: Verify that conditions are satisfactory for installation of each item of site elements. When unsatisfactory conditions exist, do not begin installation until such conditions have been corrected.
- B. Installation: Install products in conformance with the manufacturer's recommendations, Drawings and approved shop drawings, and as indicated.
  - 1. Install products square, plumb, level, accurately aligned and securely anchored.
  - 2. Repair abraded areas of shop-applied coating and areas of welds where shop-applied coating has been damaged, using a primer or galvanized repair compound compatible with the shop coating. Repair paint surface per manufacturer's specifications and District direction to match undamaged finish.
  - 3. Completion: Completed installation shall be securely anchored and free from defects and damage in material and finish.

### **3.02 GUARANTEE**

- A. At completion of project, Contractor shall provide District with written guarantee from each manufacturer identifying the nature of warranty for each product component.
- B. Contractor shall provide District with two (2) bound maintenance manuals identifying each piece of equipment on manufacturer's recommended maintenance program including, but not limited to, daily, weekly and monthly check lists.
- C. Contractor shall provide District with minimum of one (1) gallon each type and color of paint used on items with recommended surface preparation and application guidelines.

**END OF SECTION**

## SECTION 13 4713

### CATHODIC PROTECTION SYSTEM

#### PART 1 GENERAL

##### 1.01 THIS SECTION INCLUDES

- A. The WORK of this Section includes providing corrosion control systems for the following structures as outlined in this Section and on the Drawings:
  - 1. A complete cathodic protection (CP) system for metallic fittings, riser, and valves associated with the 6- and 8-inch diameter fire hydrant, fire service pipelines, and water pipelines.
  - 2. Metallic fittings associated with the 2-inch non-metallic water pipeline shall have a corrosion control system that includes wrapping the fittings in petrolatum wax tape and then encasing in concrete with a minimum of 2-inches of cover.
- B. Electrical isolation of the structures from adjacent metallic structures, steel reinforced concrete structures, casings, structures of dissimilar metal or dissimilar coatings, conduits, and all other metallic components that may impact the operation of the CP system.
- C. Electrical bonding of all non-insulated, non-welded pipe joints and mechanical joints.
- D. Installation of galvanic anodes, test stations, other components associated with the CP system, and all other work described herein and on the Drawings.
- E. Testing of CP system during installation.
- F. Cleanup and restoration of work site.
- G. Final System Checkout: Testing of CP system after installation and backfill.

##### 1.02 REQUIREMENTS

- A. If the products installed as part of this Section are found to be defective or damaged or if the WORK of this Section is not in conformance with these Specifications, then the products and WORK shall be corrected at the CONTRACTOR's expense.
- B. Any retesting required due to inadequate installation or defective materials shall be paid for by the CONTRACTOR at no additional cost to the owner.
- C. The WORK also requires that one Supplier or Subcontractor accept responsibility for the WORK, as indicated, but without altering or modifying the CONTRACTOR's responsibilities under the Contract Documents.
- D. The WORK also requires coordination of assembly, installation, and testing between the pipeline contractor and any CP material supplier or subcontractor.
- E. All electrical WORK shall be in accordance with NEC and local requirements.

### 1.03 RELATED SECTIONS

- A. The WORK of the following Sections applies to the WORK of this Section. Other Sections of the Specifications, not referenced below, shall also apply to the extent required for proper performance of this WORK.
1. Site Safety and Regulatory Requirements
  2. Excavation, Trenching, Backfilling, and Compacting
  3. Piping
  4. Cast-In-Place Concrete
  5. Protective Coatings

### 1.04 REFERENCED SPECIFICATIONS, CODES AND STANDARDS

- A. The WORK of this Section shall comply with the current editions of the codes and standards referenced in this specification, including the following:
1. AASHTO American Association of State Highway and Transportation Officials
    - a. H20 Specification for Highway Bridges
  2. ASTM ASTM International
    - a. A615 Standard Specification for Deformed and Plain Carbon-Steel Bars for Concrete Reinforcement
    - b. B3 Standard Specification for Soft or Annealed Copper Wire
    - c. B8 Standard Specification for Concentric-Lay-Stranded Copper Conductors, Hard, Medium-Hard, or Soft
    - d. B187 Standard Specification for Copper, Bus Bar, Rod, and Shapes and General Purpose Rod, Bar, and Shapes
    - e. B843 Standard Specification for Magnesium Alloy Anodes for Cathodic Protection
    - f. C94 Standard Specification for Ready-Mixed Concrete
    - g. D1248 Standard Specification for Polyethylene Plastics Extrusion Materials for Wire and Cable
    - h. G97 Standard Test Method for Laboratory Evaluation of Magnesium Sacrificial Anode Test Specimens for Underground Applications
  3. AWWA American Water Works Association

- a. C217 Petrolatum and Petroleum Wax Tape Coatings for the Exterior of Connections and Fittings for Steel Water Pipelines
  - 4. NSF National Sanitation Foundation
    - a. NSF 61 Drinking Water System Components
  - 5. NACE International, the Corrosion Society
    - a. RP0375 Field-Applied Underground Wax Coating Systems for Underground Pipelines: Application, Performance, and Quality Control
    - b. SP0169 Control of External Corrosion on Underground or Submerged Metallic Piping Systems
    - c. SP0286 Electrical Insulation of Cathodically Protected Pipelines
    - d. TM0497 Measurement Techniques Related to Criteria for Cathodic Protection on Underground or Submerged Metallic Piping Systems
  - 6. NFPA National Fire Protection Association
    - a. NFPA 70 National Electric Code (NEC)
  - 7. NEMA National Electrical Manufacturers Association
    - a. TC2 Electrical Polyvinyl Chloride (PVC) Tubing and Conduit
    - b. TC3 PVC Fittings for Use with Rigid PVC Conduit and Tubing
  - 8. UL Underwriters Laboratories
    - a. 467 Grounding and Bonding Equipment
- B. Whenever the Drawings or these Specifications require a higher degree of workmanship or better quality of material than indicated in the above codes and standards, these Drawings and Specifications shall prevail.

#### 1.05 PERMITS AND JOB ACCESS

- A. Prior to the start of construction, the CONTRACTOR shall apply to the required authorities for permits required for installation of the CP system.
- B. The CONTRACTOR shall contact Underground Service Alert prior to commencing construction to locate existing utilities in the area of construction. Existing utilities include, but are not limited to, water lines, gas lines, telephone, street lights, sewer and storm drains and overhead and underground electric utilities.
- C. If traffic control is necessary, it shall satisfy the requirements of the governing locality.

### **1.06 QUALITY ASSURANCE**

- A. Installation of the CP equipment shall be performed by individuals having at least five years of experience in the installation of the CP equipment described herein.
- B. All testing required to be performed by a “Corrosion Technician” shall be performed by a NACE certified Corrosion Technician under the supervision of a Corrosion Engineer. A Corrosion Technician is a NACE CP2 (CP Technician), CP3 (CP Technologist), or CP4 (CP Specialist). A Corrosion Engineer is a Registered Professional Corrosion Engineer or a NACE CP4 (CP Specialist).

### **1.07 SUBMITTALS**

- A. The following shall be submitted to the ENGINEER prior to any equipment installation.
  - 1. Catalog cuts, bulletins, brochures, or data sheets for all materials specified herein.
  - 2. Statement that the equipment and materials proposed meet the Specifications and the intent of the Specifications.
  - 3. Statement of installation experience required.
  - 4. Schedule, including the expected start date and planned completion date.
- B. The following shall be submitted to the ENGINEER after completion of the WORK.
  - 1. Wire connection testing.
  - 2. Joint bond testing, before and after backfill.
  - 3. Final System Checkout Report.
  - 4. Record Drawings shall be submitted to and approved by the ENGINEER before the WORK is considered complete.

### **1.08 INTERFERENCE AND EXACT LOCATIONS**

- A. The locations of CP equipment, test stations, devices, outlets, and appurtenances, as indicated are approximate only. Exact locations shall be determined by the CONTRACTOR in the field subject to the approval of the ENGINEER.
- B. The CONTRACTOR shall field verify all data and final locations of work done under other Sections of the Specifications required for placing of the electrical work.
- C. In case of interference with other work, foreign pipeline, or erroneous locations with respect to equipment or structures, the CONTRACTOR shall furnish all labor and materials necessary to complete the WORK in an acceptable manner to the OWNER. Deviations from the Drawings and Specifications shall be submitted to the OWNER for approval.

**PART 2 PRODUCTS**

**2.01 GENERAL**

- A. All materials installed must be new. All equipment and materials supplied shall be similar to that which has been in satisfactory service for at least 5 years.

**2.02 GALVANIC ANODES**

- A. Standard-potential magnesium anodes: Cast magnesium anodes shall conform to ASTM B843 Type AZ63B (commonly known as H1A). Anodes shall have an open circuit potential of 1.53 to 1.55 volts and current efficiency of 45 to 55% when tested in accordance with ASTM G97. Anodes shall have the following size, form, and shape. Anodes shall be manufactured by Farwest, Corpro, Mesa, Matcor, or equivalent.

Ingot				Packaged		
Weight (lb)	Width (inch)	Height (inch)	Length (inch)	Weight (lb)	Diameter (inch)	Length (inch)
32	5 to 6	5 to 6	20 to 21	68 to 70	8 to 9	28 to 30

- B. Galvanic anodes shall be pre-packaged in a cloth bag containing backfill of the following composition: 75% gypsum, 20% bentonite, and 5% sodium sulfate. The anodes shall be of the size indicated on the Drawings and placed where indicated on the Drawings.
- C. Anode lead wire:
  1. The wire attached to the anodes shall be of the size and type indicated on the Drawings. The anode lead wire shall conform to the specifications given for "Wires" in this specification.
  2. Connection of wire to the anode shall have a pulling strength that exceeds the wire's tensile strength.
  3. Anode lead wires shall be of one continuous length, without splices, unless otherwise indicated on the Drawings, from the anode connection to the test station.

**2.03 READY-MIXED CONCRETE**

- A. Ready-mixed concrete shall be in accordance with ASTM C94, permit requirements, and the Specification section for cast-in-place concrete.

**2.04 REINFORCING STEEL**

- A. Reinforcing steel shall be in accordance with ASTM A615, permit requirements, and the Specification section for reinforcing steel.

## **2.05 FLUSH-MOUNTED TEST STATION**

- A. Flush-mounted test station boxes shall be traffic boxes rated to withstand AASHTO H20 traffic loading.
- B. The traffic boxes shall be G05 Utility Boxes, as manufactured by Christy Concrete Products, Inc.; No. 3RT Utility Box, as manufactured by Brooks Products; or an approved equivalent.
- C. Traffic box covers for test stations shall be cast iron with welded bead legend and labeled "CP TEST" or "ANODE," as required.

## **2.06 TERMINAL BOARDS**

- A. Terminal boards shall be made of 1/4-inch thick phenolic plastic and sized as indicated on the Drawings.
- B. Connection hardware shall be brass or bronze. All connections shall be double nutted bolts with serrated lock washers.
- C. Copper bus bar shall be 1/8-inch thick and sized to fit. The copper bus bar shall be per ASTM B187 with 98% conductivity.

## **2.07 MECHANICAL LUGS**

- A. Mechanical lugs shall be brass or copper with a brass, copper, or stainless-steel set screw. Tin plating on the lugs is optional. Aluminum lugs shall not be permitted. Zinc-plated steel set screws shall not be permitted. The lug shall be listed per UL 467, suitable for direct burial, and appropriately sized for the incoming wires. The lug shall be ILSCO Type XT-6DB, Burndy GKA8C, or an approved equivalent.

## **2.08 SHUNTS**

- A. Shunts shall be the selected by the size indicated on the Drawings.
- B. 0.01-ohm, 6-amp shunts shall be manganin wire type, as indicated. Shunts shall be Type RS, as manufactured by Holloway, or equivalent.

## **2.09 CONDUIT AND FITTINGS**

- A. The minimum conduit size shall be 1 inch unless otherwise indicated. Refer to NFPA 70 (NEC) for additional conduit size requirements.
- B. Conduit and fittings placed below grade shall be Schedule 80 PVC in accordance with NEMA TC2 and NEMA TC3.

## **2.10 CAUTION TAPE**

- A. The caution tape shall be an inert plastic film designed for prolonged underground use. The caution tape shall be a minimum of 3 inches wide and a minimum of 4 mils thick.
- B. The caution tape shall be continuously printed over the entire length with the wording "CAUTION: CATHODIC PROTECTION CABLE BURIED BELOW."

- C. The wording shall be printed using bold black letters. The color of the tape shall be red.

## **2.11 WIRES**

- A. Conductors shall consist of stranded copper of the gauge indicated on the Drawings. Wire sizes shall be based on American Wire Gauge (AWG). Copper wire shall be in conformance with ASTM B3 and ASTM B8.
- B. Insulation Type and Colors: As shown on the Drawings.
  - 1. High molecular weight polyethylene (HMWPE) wires shall be rated for 600 volts and shall conform to ASTM D1248, Type 1, Class C, Grade 5.

## **2.12 WIRE IDENTIFICATION TAGS**

- A. Wire identification tags shall be the wrap-around type with a high resistance to oils, solvents, and mild acids. Wrap-around markers shall fully encircle the wire with imprinted alpha-numeric characters for pipe identification. The letters and numbers height shall be 3/16 inch at minimum.

## **2.13 EXOTHERMIC WELDS**

- A. Exothermic welds shall be in accordance with the manufacturer's recommendations. Exothermic welds shall be Cadweld manufactured by Erico, Thermoweld manufactured by Burndy, or an approved equivalent.
- B. Prevent molten weld metal from leaking out of the mold, where necessary, by using Duxseal packing manufactured by Johns-Manville, Thermoweld packing material manufactured by Burndy, Cadweld T403 Mold Sealer manufactured by Erico, or an approved equivalent.
- C. The shape and charge of the exothermic weld shall be chosen based on the following parameters:
  - 1. Pipe material
  - 2. Pipe size
  - 3. Wire size and requirement for sleeves
  - 4. Number of wires to be welded
  - 5. Orientation of weld (vertical or horizontal)

## **2.14 EXOTHERMIC WELD COATING**

- A. After exothermic welding, repair coatings and linings in accordance with the coating and lining manufacturer's recommendation.



- B. For bare steel, dielectrically coated steel, or ductile iron pipe, weld caps with integrated primer shall be used to cover the exothermic weld connecting the wire to the pipe. The weld cap shall be a 10-mil thick durable plastic sheet that has a dome filled with a moldable compound to assure complete encapsulation of the exothermic weld and a layer of elastomeric adhesive with integrated primer. The adhesive and primer shall be compatible with the pipe material and pipe coating material. Adhesion to steel shall be at least 10 lb/in per ASTM D1000. Weld cap with integrated primer shall be Handy Cap IP manufactured by Royston or equivalent for wire size up to 8 AWG and Handy Cap XL IP manufactured by Royston or equivalent for wire size up to 2 AWG.

## **2.15 PETROLATUM WAX TAPE**

- A. Petrolatum wax tape shall meet or exceed the requirements of AWWA C217 and shall consist of three parts: Surface primer, wax tape, and outer covering. All three parts shall be the product of a single manufacturer.
- B. The primer shall be a blend of petrolatums, plasticizers, and corrosion inhibitors having a paste-like consistency. Primer shall be Wax-Tape Primer manufactured by Trenton, Denso Paste manufactured by Denso, or approved equivalent.
- C. The wax tape shall be synthetic-fiber felt, 45 to 90 mils thick, saturated with a blend of micro-crystalline wax, petrolatums, plasticizers, and corrosion inhibitors that is capable of easy conformability over irregular surfaces. Wax tape shall be #1 Wax-Tape manufactured by Trenton, Denso Tape manufactured by Denso, or approved equivalent.
- D. The outer covering shall be a plastic wrap consisting of one 150-gauge sheet or three 50-gauge sheets wound together as a single sheet, clear polyvinylidene chloride, shrink wrap that is flexible enough to conform to irregular surfaces. Outer wrapping shall be Poly-Ply by Trenton, Poly-Wrap by Denso, or approved equivalent.

## **PART 3 EXECUTION**

### **3.01 MATERIAL AND EQUIPMENT STORAGE**

- A. All materials and equipment to be used in construction shall be stored in such a manner to be protected from detrimental effects from the elements. If warehouse storage cannot be provided, materials and equipment shall be stacked well above ground level and protected from the elements with plastic sheeting or another method, as appropriate.

### **3.02 EXCAVATION AND BACKFILL**

- A. Buried wires shall have a minimum cover of 24 inches.
- B. Caution tape shall be installed above buried wire. Caution tape shall be installed a minimum of 6 inches above underground wires and conduits.
- C. Anode wire identification tags shall be placed on the wires prior to placing wire in conduit or backfilling.

### **3.03 SURFACE GROUND BED FOR GALVANIC ANODES**

- A. Prepackaged anodes shall be installed at the locations indicated on the Drawings.
- B. Plastic or paper wrapping shall be removed from the anode prior to lowering the anode into the hole. Anodes shall not be suspended by the lead wires. Damage to the canvas bag, anode-to-wire connection, copper wire, or wire insulation before or during installation will require replacement of the entire anode assembly. Anodes shall be inspected and approved prior to backfilling.
- C. Anodes shall be backfilled with native soil. Backfilling with native soil shall proceed in 6-inch lifts, compacting the soil around the anode during each lift, until the backfill has reached grade. Upon completion of compaction of backfill to the top of the anode, and prior to filling the hole and compacting the backfill to the surface, a minimum of 10 gallons of fresh water shall be poured into the hole to saturate the prepackaged anode backfill and surrounding soil.
- D. Anode lead wires shall be routed and terminated on the panel board as shown in the Drawings.

### **3.04 TEST STATIONS**

- A. Test stations shall be installed at the approximate locations shown on the Drawings. The CONTRACTOR shall field verify all final locations, subject to acceptance by the ENGINEER. Test stations shall be located within the pipeline easement. Test stations shall be located in areas not subject to vehicular traffic, such as sidewalks, unless otherwise approved by the ENGINEER.
- B. For flush-mounted test stations, place the bottom of the test box on native soil. Do not place rock, gravel, sand, or debris in the box. Install 4,000 psi concrete collar with reinforcement after placement of the test box to finished grade. Provide sufficient sloping in the concrete pad or surrounding pavement to provide drainage away from the test box.
- C. Connect wires to the terminal board as shown on the Drawings. Each wire shall be identified with a permanent wire identifier within 4 inches of the termination. After installation, all wire connections in the test station shall be tested by the Contractor to ensure they meet the requirements herein.
- D. For foreign pipeline test stations, the CONTRACTOR shall notify the owner of foreign utility piping for which foreign pipeline crossing test stations are to be installed. Notification shall be provided at least 2 weeks in advance. Test leads to foreign pipelines shall be installed in the presence and to the satisfaction of a representative of the foreign pipeline owner.
- E. The CONTRACTOR shall provide global positioning system (GPS) coordinates for each test station location with a minimum accuracy of 1 meter or 3 feet. The CONTRACTOR shall submit the GPS coordinates of the test stations to the ENGINEER after installation.

### **3.05 WIRES**

- A. Buried wires shall be laid straight without kinks. Each wire run shall be continuous in length and free of joints or splices, unless otherwise indicated. Care shall be taken during installation to avoid punctures, cuts, or other damage to the wire insulation. Damage to insulation shall require replacement of the entire length of wire at the CONTRACTOR's expense.
- B. At least 12 inches of slack (coiled) shall be left for each wire at each flush-to-grade test station. Wire slack shall be sufficient to allow removal of wire extension for testing.
- C. Wire shall not be bent into a radius of less than eight times the overall wire diameter.
- D. The wire conduits must be of sufficient diameter to accommodate the wires. This shall be determined by the number and size of wires in accordance with the applicable codes and standards.
- E. Conduit shall be installed to a minimum depth of 24 inches below grade.
- F. Install caution tape above buried wire and conduits at a maximum depth of 12 inches below grade. Every 3 feet, double over the tape for a distance of 8 inches to increase the apparent flexibility of the tape.

### **3.06 WIRE IDENTIFICATION TAGS**

- A. All wires shall be coded with wire identification tags within 4 inches of the wire end indicating diameter and type of pipe.
- B. Wire identification tags shall be placed on all wires prior to backfill and installation of test stations.

### **3.07 EXOTHERMIC WELD CONNECTIONS**

- A. Exothermic weld connections shall be installed in the manner and at the locations indicated. Exothermic welds shall be spaced at least 6 inches apart from other exothermic welds, fittings, and circumferential welds.
- B. Coating materials shall be removed from the surface over an area of sufficient size to make the connection and as indicated on the Drawings. The surface shall be cleaned to bare metal per SSPC SP11 prior to welding the conductor. The use of resin impregnated grinding wheels will not be allowed.
- C. Only enough insulation shall be removed such that the copper conductor can be placed in the welding mold. If the wire conductor diameter is not the same as the opening in the mold, then a copper adapter sleeve shall be fitted over the conductor.

- D. The CONTRACTOR shall be responsible for testing all test lead and bond wire welds. The ENGINEER, at his or her discretion, shall witness these tests. After the weld has cooled, all slag shall be removed, and the metallurgical bond shall be tested for adherence by the CONTRACTOR. A 22-ounce hammer shall be used for adherence testing by striking a blow to the weld. Care shall be taken to avoid hitting the wires. All defective welds shall be removed and replaced in a new location at least 6 inches away from the original weld location.
- E. All exposed surfaces of the copper and steel shall be covered with insulating materials.
  - 1. For dielectrically coated pipes, a plastic weld cap with integrated primer shall cover the exothermic weld and surrounding area. All surfaces must be clean, dry, and free of oil, dirt, loose particles, and all other foreign materials prior to application of the weld cap.
- F. The CONTRACTOR shall inspect both the interior and exterior of the pipe to confirm that all coatings and linings removed or damaged as a result of the welding have been repaired. The CONTRACTOR shall furnish all materials, clean surfaces, and repair protective coatings and linings damaged as a result of the welding. Repair of any coating or lining damaged during welding shall be performed in accordance with coating or lining manufacturer's recommendations.
- G. After backfilling pipe, all test lead pairs shall be tested for broken welds using a standard ohmmeter. The resistance shall not exceed 150% of the theoretical wire resistance, as determined from published wire data.

### **3.08 JOINT BONDS**

- A. Joint bonding shall be provided across flexible couplings and all non-welded joints to ensure electrical continuity, except where insulating joints have been installed to provide electrical isolation. Joint bonds shall be of the type, size, length, and number shown on the Drawings and installed as indicated.
- B. Bonding wires shall allow at least 2 inches of movement in the pipe joint. The wire shall be attached by exothermic welding. At least 2 bond wires shall be provided between all discontinuous joints.
- C. For ductile iron pipe, the CONTRACTOR may, at his or her own expense, provide weld plates that are installed by the pipe manufacturer at the spigot end of the pipe. Provision of the weld plates does not relieve the CONTRACTOR from responsibility for repair of damage to the coating or lining as a result of exothermic welding of the pipe. Coating repairs shall be performed in accordance with coating manufacturer's recommendations.

### **3.09 PETROLATUM WAX TAPE**

- A. Petrolatum wax tape systems shall be applied on insulating joints and non-cathodically protected metallic appurtenances and fittings, regardless of whether they are bare or factory coated, as indicated in the Drawings. Extend the petrolatum wax tape coating system over any adjacent pipe coating by a minimum of two pipe diameters. Petrolatum wax tape systems shall be applied in accordance with NACE RP0375, AWWA C217, these Specifications, and the Manufacturer's recommendations.

- B. Surfaces shall be cleaned of all dirt, grease, oil and other foreign materials immediately prior to coating. Loose rust, loose paint and other foreign matter shall be removed in accordance with SSPC SP2 or SP3.
- C. A prime coating shall be applied in a uniform coating over the entire surface to be wrapped. A liberal coating shall be applied to threads, cavities, shoulders, pits, and other irregularities.
- D. Petrolatum wax tape shall be applied immediately after applying the primer using a 1-inch overlap. A spiral wrap shall be used, and slight tension shall be applied to ensure that there are no air pockets or voids. For bolts, nuts, and other irregular shapes, cut strips of wax tape and apply them by gloved hand so that there are no voids or spaces under the tape. Apply a sufficient amount of tape to completely encapsulate all exposed steel surfaces. After applying the tape, the applicator shall firmly press and smooth out all lap seams and crevice areas. The tape shall be in tight intimate contact with all surfaces. The minimum wax tape thickness shall be 70 mils over smooth surfaces and 140 mils over sharp and irregular surfaces, or more as required to fill all voids.
- E. Apply two layers of outer covering over the wax tape coating by tightly wrapping it around the pipe such that it adheres and conforms to the wax tape. Secure the outer covering to the pipe with adhesive tape.

### **3.10 WIRE CONNECTIONS**

- A. After installation, all wire connections shall be tested to ensure electrical continuity at the test station locations by the CONTRACTOR to ensure that they meet the requirements and intent of the Contract Documents.

### **3.11 RESTORATION SERVICES**

- A. Compaction of backfill for anodes and trenches shall match the existing conditions and shall be in conformance with the EARTH MOVING Section (31 20 00).
- B. RESTORATION OF SOD: Restore unpaved surfaces disturbed during the installation of anodes and wires to their original elevation and condition. Preserve sod and topsoil carefully and replace after the backfilling is completed. Replace sod that is damaged using sod of quality equal to that removed. Where the surface is disturbed in a newly seeded area, re-seed the area with the same quality and formula of seed as that used in the original seeding.
- C. RESTORATION OF PAVEMENT: Patch pavement, sidewalks, curbs, and gutters where existing surfaces are removed for construction in conformance with the ASPHALT PAVING Section (32 12 16) and the CAST-IN-PLACE CONCRETE Section (03 30 00).

### **3.12 FINAL SYSTEM CHECKOUT**

- A. Upon completion of the installation, the CONTRACTOR shall provide testing of the completed system by a Corrosion Technician, and the data shall be reviewed by a Corrosion Engineer to ensure conformance with the Contract Documents, NACE SP0169, and NACE SP0286.
- B. The testing described herein shall be in addition to and not substitution for any required testing of individual items at the manufacturer's plant and during installation.

- C. Testing shall be performed at all test leads of all test stations, junction boxes, and locations of exposed pipe as soon as possible after installation of the CP system.
- D. Testing shall include the following and shall be conducted in accordance with NACE TM0497:
  - 1. Measure and record native pipe-to-soil and anode-to-soil potentials at all test locations. CONTRACTOR shall submit data to ENGINEER a minimum of 48 hours before energizing the cathodic protection system.
  - 2. Confirm electrical continuity of the cathodically protected pipeline or structure.
  - 3. Measure and record the "On" and "Instant Off" pipe-to-soil potentials at each location after the structure has been given adequate time to polarize.
  - 4. Measure and record the current output of each anode when the CP system is initially turned on and again after it has been given adequate time to polarize. 0286
- E. Test results shall be analyzed to determine compliance with NACE SP0169.
- F. The CONTRACTOR shall provide a written report, prepared by the Corrosion Engineer, documenting the results of the testing and recommending corrective work, as required to comply with the Contract Documents. Any deficiencies of systems tested shall be repaired and re-tested by the CONTRACTOR at no additional cost to the OWNER.

**END OF SECTION**

## SECTION 21 0000

### FIRE PROTECTION GENERAL

#### PART 1 - GENERAL

##### 1.1 GENERAL

- A. The General Conditions and Supplementary General Conditions are hereby a part of this Section as fully as if repeated herein.

##### 1.2 SCOPE

- A. The work includes, but is not necessarily limited to, the furnishing of all labor, materials, equipment, and services necessary for, and reasonably incidental to, providing and installing complete fire protection systems, and other work as shown or indicated in the Fire Protection Drawings and Specifications.
- B. Consult all other Sections to determine the extent and character of this work specified elsewhere.
- C. Specifically refer to the following:
  - Section 21 0500            Overhead Fire Protection Systems
  - Section 21 1000           Underground Fire Service
- D. Make all connections to equipment requiring service from systems installed under this Section.

##### 1.3 COORDINATION

- A. Before submitting a bid for the fire protection work the Contractor shall visit the site and become familiar with all the work on other related Drawings and Specifications, and plan the work to provide the best possible assembly of the combined work of all trades. No additional costs will be considered for work which has to be relocated due to conflicts with other trades.
- B. If, after examination of the bidding documents relating to the work, the Contractor has queries concerning the nature and scope of the work or intent of the Specifications, he/she shall promptly request clarification from the Architect. After contract award, claims of ignorance of the intent and scope of the contract shall not be allowed.
- C. Contractor is responsible for coordinating the schedule of inspections by Engineer at appropriate stages of construction such as rough-in, pre-final, and final, and at other times required by the Specifications or by the construction. Notify Architect and Engineer seven (7) days in advance of proposed site visit. Notification constitutes certification that construction is, or will be, complete and ready for inspection.
- D. Coordination Drawings: All work of this section must be coordinated to clear all work of other sections. Provide coordination drawings for all work of this section/division; see Division 01. For site utilities, see architectural drawings for additional coordination requirements.

#### 1.4 COORDINATION DRAWINGS

- A. The contractor shall prepare and submit, for review, large scale (minimum 1/8" = 1'-0") coordination drawings showing location and elevations of all equipment, ducts, piping, cable trays, conduits, structural, and other items in the area. These shall be fully coordinated with all other trades and Owner supplied items. Check routing and elevations of all piping, ductwork, conduit and equipment before fabricating. Report any conflicts that cannot be solved in the field to the Architect/Engineer. Extra charges shall not be allowed due to lack of coordination prior to, or during, construction. These drawings shall be distributed to, and coordinated with, all other trades that are affected.
1. In addition to plan view, indicate heights to clarify clearances from structure and from other trades. Use partial sections where necessary.
  2. Provide proper clearances for access to and service of all equipment and items requiring adjustment including shutoff valves.
  3. Coordinate the location of access panels in the hard ceiling areas to insure all equipment and devices have proper access for servicing and adjusting.
  4. The coordination drawings shall be reviewed and checked for completeness by the general contractor. Review by the architect and engineer is to assist the contractor and to attempt to point out obvious errors. Responsibility for proper coordination shall remain with the contractor.
- B. Differences or disputes concerning coordination, interference, or extent of work between sections shall be decided by general contractor.
- C. Extra charges shall not be allowed due to lack of coordination (or lack of coordination drawings) prior to or during construction.
- D. Indicate locations where space is limited for installation and access and where sequencing and coordination of installations are of importance to the efficient flow of the Work. Indicate the proposed locations of ductwork, piping, conduit, equipment, and materials. Include the following:
1. Clearances for installing and maintaining insulation, including clearances for servicing and maintaining equipment, and space for equipment disassembly required for periodic maintenance.
  2. Clearances for electrical and control components and panels.
  3. Equipment connections and support details.
  4. Exterior wall and foundation penetrations.
  5. Interior floor penetrations
  6. Fire rated wall and floor penetrations.
  7. Sizes and location of required concrete pads and bases.
  8. Support, bracing and anchor locations for equipment and conduit.
- E. Indicate scheduling, sequencing, movement, and positioning of large equipment into the building during construction.
- F. Prepare floor plans, elevations, and details to indicate penetrations in floors, walls, and ceilings and their relationship to other penetrations and installations.



- G. Prepare reflected ceiling plans to coordinate and integrate installations, access panel and door locations, air outlets and inlets, light fixtures, communication systems components, sprinklers, and other ceiling mounted items where ceilings are to be installed.

#### **1.5 SAFETY**

- A. Contractors must conduct a weekly safety meeting with their employees and provide documentation as to attendance and topics of discussion. Engineer's construction support services do not constitute review or approval of Contractor's safety procedures. Contractor shall comply with all OSHA regulations. Contractor is required to obtain and pay for insurance required to cover all activities within Contractor's Scope of Work.

#### **1.6 BUILDING LAWS**

- A. Fire Protection work shall conform to all requirements prescribed by governmental bodies having jurisdiction and is to be in accordance with the California Building Code; all federal, state, and local codes and ordinances; all OSHA requirements; California Plumbing Code, California Mechanical Code, California Fire Code, and National Fire Protection Association; California State Code Title 8, Title 21, Title 24; and the Energy Conservation Standards.
- B. Should any part of the design fail to comply with such requirements, the discrepancy shall be called to the attention of the Architect prior to submitting bid.
- C. Should there be any direct conflict between the Drawings and/or Specifications and the above rules and regulations, the rules and regulations shall take precedence. However, when the indicated material, workmanship, arrangement, or construction is of a superior quality or capacity to that required by above rules and regulations, the Drawings and/or Specifications shall take precedence. Rulings and interpretations of enforcing agencies shall be considered as part of the regulations.
- D. After a Contract is awarded, if minor changes or additions are required by the aforementioned authorities, even though such work is not shown on Drawings or overtly covered in the Specifications, they must be included at the Contractor's expense.
- E. The Contractor is responsible to coordinate and make adjustments in his/her work with the full set of Contract Drawings and Specifications.
- F. All piping, and equipment shall be securely anchored to building structure as required herein and by the California Building Code and NFPA 13.

#### **1.7 UNDERGROUND CONNECTIONS**

- A. See Section 21 10 00 for Underground Fire Service connection requirements.

#### **1.8 TEMPORARY CONSTRUCTION WATER**

- A. The Contractor shall make all arrangements and provide necessary facilities for the temporary construction water from the Owner's source. Costs for the temporary construction water shall be paid for by Owner.

## 1.9 PAINTING

- A. See Section 09 for painting of piping, equipment, etc.

## PART 2 - PRODUCTS

### 2.1 MATERIALS

- A. All materials used shall be new as listed in subheadings and indicated on Drawings. Inspect all materials and immediately remove defective materials from the site.
- B. All electrical materials shall bear the label of, or be listed by, the Underwriters' Laboratories (UL), unless the material is of a type for which label or listing service is not provided.
- C. Substitution:
  - 1. No substitute materials or equipment may be installed without the written approval of the Architect.
  - 2. Use of substitute materials or equipment may require changes in associated materials and equipment. Contractor shall submit detailed Shop Drawings and installation instructions of substitute materials and equipment to Architect for approval. Such submittals shall address all changes required in other items.
  - 3. All additional costs incurred by the substitution of material or equipment, or the installation thereof whether Architectural, Structural, Mechanical, Plumbing, or Electrical shall be borne by the Contractor who substitutes the materials or equipment in place of the items specified.
- D. Quality of Materials: Pipe fittings and equipment may be taken from stock but the Contractor will be required to submit manufacturer's certificates identifying the material and equipment furnished as conforming with these Specifications and such codes and standards as apply to the equipment specified. Any material on the site which cannot be identified by manufacturer's mark shall be removed from the site at Architect's request.

### 2.2 SUBMITTALS

- A. The review of submittals and approval thereof by the Architect does not relieve the Contractor from compliance with the requirements and intentions of the Drawings and Specifications to which the submittals pertain. The contractor acknowledges its responsibility to submit complete shop drawings and other required submittals. Incomplete submittals will be returned to the contractor unreviewed.
- B. Material List: An itemized list of material and equipment which the Contractor proposes to use shall be submitted to the Architect with number of copies indicated and within time indicated.
- C. Shop Drawings and Product Data:
  - 1. Submit all required Shop Drawings, product data, etc. at one time. Submittals shall be bound, tabbed, and properly indexed by Specification Section.
  - 2. Each item shall be identified by manufacturer, brand, and trade name; model number, size, rating, and whatever other data is necessary to properly identify and verify the materials and equipment. The words "AS SPECIFIED" will not be considered sufficient information.

3. Each submittal shall bear the Contractor's stamp and mark indicating the Contractor has reviewed and approved the submittal.
4. Each submitted item shall refer to the Specification Section and paragraph in which the item is specified.
5. Accessories, controls, finish, etc. not required to be submitted or identified with the submitted equipment shall be furnished and installed as specified.
6. Submittals shall be all inclusive with all items requiring submittals being submitted at the same time; individual submittals will not be accepted.
7. Place orders for all equipment in time to prevent any delay in construction schedule or completion of project. If any materials or equipment are not ordered in time, additional charges made by equipment manufacturers to complete their equipment in time to meet construction schedule, together with any special handling charges, shall be borne by Contractor.

### **PART 3 - EXECUTION**

#### **3.1 DRAWINGS**

- A. The Contract Drawings show the general arrangement and location of the piping and equipment. Work shall be installed in accordance with the Drawings, except for changes required by conflicts with the work of other trades. The Contractor shall provide for the support, expansion, and pitch of any rearranged piping in conformance with the intent of the Drawings, Specifications, and codes.
- B. Note that certain fire protection work is shown, wholly or in part, on Architectural Drawings.
- C. The contractor shall field verify existing conditions and provide accurate shop coordination drawings for coordination with other trades in accordance with Division 1.
- D. Fire Protection Drawings are diagrammatic and are intended to show the approximate location of equipment and piping. Dimensions shown on Drawings shall take precedence over scaled dimensions on Drawings. All dimensions shall be verified in the field by the Contractor.
- E. The exact location of apparatus, equipment, and piping shall be ascertained from the Architect or the Architect's representative in the field, and work shall be laid out accordingly. Should the Contractor fail to ascertain such locations the work shall be changed at Contractor's own expense when so ordered by the Architect. The Architect reserves the right to make minor changes in the location of piping and equipment up to the time of installation without additional cost.
- F. It is the intention of the Drawings and Specifications that, where certain items such as unions, expansion joints, and other mechanical components are not shown, but where such items are required by the nature of the work, shall be furnished and installed.
- G. The Fire Protection Drawings and Specifications are intended to supplement each other. Any material or labor called for in one shall be furnished even though not specifically mentioned in the other.

- H. Pipe sizes shown are the minimum allowable and shall be increased in size if required by code or wherever necessary to meet unusual conditions.

### 3.2 RECORD DRAWINGS

- A. Record Drawings shall be maintained at all times showing the exact location of piping mains, branches, valves, drains, etc. installed under all Sections. Obtain from the Architect, at cost, a complete set of prints. On these prints systematically and accurately keep a dimensional record of all work installed different from those shown on Drawings. Have these Drawings readily available for reference.
- B. Record Set: When above information is complete and acceptable to the Architect transfer this information accurately to reproducible tracings, purchased at cost from the Architect for this purpose, and deliver to the Architect for final review.
- C. Upon completion of the Architect's review of the Record Set the Contractor shall incorporate changes, as noted on the record set, including dimensions such as elevations, valves, etc. Deliver transparencies with one (1) set of prints to the Architect. Deliver one (1) complete set of prints to building Owner within ninety (90) days of issuance of final occupancy report.
- D. Inspector's Approval: Where a full-time inspector is employed by the Owner, the Record Drawing information shall be reviewed by the inspector during the course of construction and shall have the inspector's approval before submission to the Architect.

### 3.3 ACCEPTANCE TESTS

- A. Documentation on standard NFPA Acceptance forms and inspection documents shall be submitted to the Architect and DSA Inspector of Record.
- B. The required acceptance documents shall be signed by a licensed C-16 Contractor.

### 3.4 DAMAGE

- A. Repair any damage to the building, premises, and equipment occasioned by the work under this Section.
- B. Repair all damage to any part of the building or premises caused by leaks or breaks in pipe, or malfunctions of equipment furnished or installed under this Section until the warranty period expiration date.

### 3.5 COMPLETE WORKING INSTALLATION

- A. The Drawings and Specifications do not attempt to list every item that must be installed. When an item is necessary for the satisfactory operation of equipment, is required by the equipment manufacturer, or accepted as good practice, furnish without change in Contract cost.

### 3.6 STORAGE

- A. Provide proper protection and storage of all items and tools required for this work.

### **3.7 QUALITY OF WORK**

- A. The quality of work shall be of a standard generally accepted in the respective trade. Use only experienced, competent, and properly equipped workers. Replace work falling below this standard as directed by the Architect.
- B. Systems shall be worked into a complete and integrated arrangement with like elements arranged to make a neat appearing and finished piece of work, with adequate head room and passageway free from obstructions. Such systems shall be installed by laborers experienced in the respective trades involved.

### **3.8 CONCRETE WALLS AND CONCRETE FOOTINGS**

- A. Where pipes must pass through concrete walls and footings, they shall pass through Schedule 40 galvanized pipe sleeves set in place at time of construction. The sleeves shall provide clearance in accordance with NFPA 13
- B. Coordinate core drilled openings with Architect and General Contractor. Coordination shall include location, size, and spacing of openings. No slot openings will be allowed. Coordinate openings to avoid critical structural items such as reinforcing bars, tensioning tendons, etc.
- C. Also see Paragraph 3.15.

### **3.9 ELECTRICAL REQUIREMENTS - CONTROLS AND COORDINATION WITH ELECTRICAL CONTRACTOR**

- A. The Fire Protection Contractor shall coordinate with the Electrical Contractor on furnishing and installing of controls, motors, starters, etc. Coordinate means informing Electrical Contractor of items requiring electrical connection, providing copies of submittal data, installation data, scheduling work to insure efficient progress, and promptly supplying those items to be installed by Electrical Contractor.
- B. The specific requirements for electrical power and/or devices for each and every piece of fire protection equipment requiring electrical service, supplied and/or installed under this Contract, shall be coordinated and verified with the Fire Protection Drawings, Fire Protection Sections of these Specifications, and with the manufacturers of the equipment supplied. This shall include the voltage, phase, and ampacity; conduit requirements; and exact location and type of disconnect, control, and/or connection required. Any changes from the Drawings and Specifications required as a result of this coordination shall be part of this Contract.
- C. Electrical Contractor shall furnish and install the following for all mechanical equipment:
  - 1. Conduit and wiring for line voltage power to the equipment.
  - 2. Disconnect switches.
  - 3. Manual motor starters.
  - 4. Magnetic motor starters when part of a motor control center. See Division 16 and Drawings for further information.
- D. The work under this Section shall include furnishing and installing all controls on low and manual line voltage, including thermostats, auxiliary switches, relay wiring, interlock wiring; equipment control panels and transformers; and controls conduit unless specifically

indicated as part of other work. Materials and methods of the control installation shall be in accordance with the Electrical Specifications.

- E. The Fire Protection Contractor shall review all wiring connections which have any influence on this equipment or work and verify that these connections are correct before permitting any equipment to be operated which is furnished, installed, or modified under this Contract.

### **3.10 ELECTRICAL REQUIREMENTS - MOTORS AND EQUIPMENT FURNISHED UNDER THIS SECTION**

- A. Motors and motor control equipment shall conform to the standards of the National Electrical Manufacturer's Association (NEMA). Motors and motor control equipment shall be as specified below. The work under this Section shall include:
  1. Furnishing all motors, magnetic starters and automatic control devices for equipment furnished and installed by this Contractor. Electrical Contractor shall provide magnetic starters at motor control center where indicated.
  2. Installation of the above motors and control devices. Manual motor starters shall be furnished and installed by Electrical Contractor in accordance with Electrical Specifications.
  3. Furnishing and installing line and/or low voltage interlock wiring shall be by the Mechanical Contractor. Installation of wire includes the connection of devices. All work shall be in accordance with the materials and methods specified in the Electrical Specifications.
  4. Furnishing and installing completely wired equipment control panels with complete controls for automatic operation where indicated or when supplied with equipment.
  5. Furnishing and installing all control and interlock wiring from equipment control panels to related remote devices, fans, motors, heaters, and controls.
  6. Wire mounted on heat producing appliances shall be Type RHH or THHN (90°C).
  7. Except as noted above, disconnect switches, power circuits from electrical panelboard to disconnect switch, starters, and motors shall be furnished and installed under the Electrical Specifications.

### **3.11 ELECTRICAL EQUIPMENT ROOM PRECAUTIONS**

- A. Piping shall not be installed in any switchgear room, transformer vault, telephone room or electric closet except as indicated. In any case, no piping shall be installed in the space equal to the width and depth of any electrical service equipment, switchboards, panel boards, or motor control centers and extending from the floor to a height of six feet above the equipment or to the structural ceiling, whichever is lower. Only sprinkler piping serving the room may be installed in those rooms.

### **3.12 CUTTING AND REPAIRING**

- A. No cutting shall be done except with Architect's approval. Cutting of structural members or footings is prohibited without the prior written consent of the Structural Engineer.
- B. Where cutting of paving, walls, ceilings, etc. is necessary for the installation of the mechanical work, it shall be done under the direction of this Section. Damage caused by this cutting shall be repaired to match original and adjacent surfaces without additional expense to the Owner.

Cutting of new construction shall be by the installing Contractor of that construction as directed by this Contractor.

**3.13 PIPE AND VALVE IDENTIFICATION**

- A. Identify all piping contents with letter legend on color background identifying hazard or use of material.
- B. The pipe marker system shall conform completely with "The Scheme for Identification of Piping Systems" (ANSI A13.1). More specifically, the pipe marker must possess the following:
  - 1. ANSI specified color coded background.
  - 2. ANSI specified color of legend in relation to background color.
  - 3. ANSI specified legend letter size.
  - 4. ANSI specified length of color field (marker length).
- C. The following tables will serve to clarify the above mentioned requirements:

TABLE 1

Outside Diameter of Pipe or Covering	Length of Color Field	Size of Letters
3/4" to 1 1/4"	8"	1/2"
1 1/2" to 2"	8"	3/4"
2 1/2" to 6"	12"	1 1/4"
8" to 10"	24"	2 1/2"
Over 10"	32"	3 1/2"

- D. All pipes 3/4" I.D. and smaller shall be marked with 1 1/2" brass tags equivalent to valve tags.
- E. Provide flow markers consisting of labels similar to pipe markers with a large black arrow printed on same background color to indicate direction of flow.
- F. Place pipe marker and flow marker on each pipe on both sides of walls or floors through which pipes pass. Place markers adjacent to valves and fittings or branch take-off and for exposed piping locate markers to be clearly visible to person standing on floor, and at not over 30'-0" intervals on all straight runs of pipe.
- G. All valves under 3/4" I.D.: 18 gauge brass identification tags 1 1/2" in diameter with depressed 1/2" high black filled letters above 1/2" black filled numbers. Tags shall be fastened securely at specified locations. Valve tags shall show valve number, purpose, and normal condition (open or closed).
- H. Tag Locations:

1. Adjacent to each valve and fitting except on plumbing fixtures and equipment.
2. At each branch and riser take-off.
3. At each pipe passage through wall, floor, and ceiling construction.
4. At each pipe passage to underground.
5. On all horizontal pipe runs, marked every 25'-0".

### **3.14 VALVE TAGS AND CHART**

- A. Furnish and install in each mechanical room a single typed valve chart identifying all valves with their respective tag numbers, size, manufacturer, model number, service, and indicating whether each valve is normally open or normally closed. Chart shall be mounted in a neat sheetmetal frame with glass front. The frame shall be arranged so that valve chart is removable. Provide three (3) additional copies of valve chart in maintenance manuals.

### **3.15 SLEEVES AND SEALING**

- A. Provide sleeves for all pipes passing through new floors, walls, partitions, and any other building construction, of adequate diameter to allow minimum clearance all around between sleeve and pipe as required by NFPA 13.
- B. Lay out work prior to concrete forming. Reinforce sleeves to prevent collapse during forming and curing.
- C. All floor sleeves required shall extend 1" above finished floor except through mechanical equipment room floors and shafts where sleeves shall extend 2" above finished floor level. Sleeves through roof shall extend 8" above roof. Wall sleeves shall be flush with face of wall unless otherwise indicated. Waste stacks using carriers shall have sleeves flush with floor and sealed.
- D. Sleeves shall permit free thermal expansion of pipe without binding or contact with structure.
- E. Do not support pipes by resting pipe clamps on floor sleeves. Supplementary members shall be provided so pipes are floor supported.
- F. Special sleeves detailed on Drawings shall take precedence over this Section.
- G. Pipe sleeves as scheduled below unless otherwise indicated:
  1. Plaster or Drywall:  
Schedule 40 galvanized steel pipe.
  2. Concrete or Masonry Walls and Concrete Bases:  
See Paragraph 3.8.
  3. Waterproof membraned floors, walls, concrete pits, foundation walls, etc. as detailed or specified in other Sections.

### **3.16 SUPPORTS**

- A. All supports and bracing shall comply with NFPA 13.



- B. All equipment and piping shall be mounted on, or suspended from, foundations and supports as specified and indicated, and seismically braced to structure.
- C. Seismic restraints shall be provided in accordance with NFPA 13.
- D. All piping and equipment shall be securely anchored to building structure as required by the Specifications, California Title 24, the California Building Code, and NFPA 13.
- E. Earthquake restraints shall be capable of resisting the gravity lateral loads required by NFPA 13.
- F. Supplemental Supports: Provide supplemental supports to span building structural elements as necessary for equipment foundations and supports. Provide Shop Drawings to Mechanical and Structural Engineers for approval prior to installation.

### 3.17 ACCESSIBILITY

- A. General: Valves, pressure gauges, and indicating equipment or specialties requiring reading, adjusting, inspection, repairing, removal, or replacement shall be conveniently and accessibly located with reference to finished building. Gauges shall be installed to be easily read from floor.
- B. Panels: No unions, flanges, valves, controls, or equipment shall be placed in a location that will be inaccessible after the system is complete. Access panels or doors shall be provided where required whether or not shown on Drawings.
- C. Access Panels in Walls or Ceilings:
  - 1. Provide access panels in walls or ceilings where indicated and where required to provide access to valves, dampers, and other appurtenances. Panels shall be style as selected by Architect and as directed by wall or ceiling construction. Panel size shall be 24" x 24" unless indicated otherwise. Panels in acoustical barriers shall have same transmission loss as barrier. Panels in rated construction shall have same rating as construction in which installed.
  - 2. Door panels shall be no lighter than 14 gauge steel. Doors shall be equipped with concealed spring hinges and flush, screwdriver operated locks, except that key operated locks shall be used for all access doors in walls where door is within 6'-0" of floor. Locks for all key operated doors shall be keyed alike.
  - 3. Doors in ceramic tile surfaces shall be stainless steel or chrome plated. Doors in other finished surfaces shall be prime coated.
- D. Equipment Spaces: Provide aisles between equipment and piping, electrical gear, etc. for complete service and inspection of equipment. Maintain minimum 6'-6" headroom in all access aisles. Maintain minimum 36" clearance at all service panels. Provide minimum clearances at electrical equipment per NEC. Provide 36" wide, 3/4" thick plywood covered catwalks in attics from access door to equipment.

### 3.18 TESTING

- A. Test all piping, equipment, and systems as called for in the Specifications. Notify Architect and inspection authorities prior to testing so that they may be witnessed. Protect all

personnel and equipment during testing. Where Specifications do not cover specific points or methods, conform to manufacturer's specifications.

### 3.19 EQUIPMENT

- A. All equipment shall be accurately set and leveled. Supports shall be neatly placed and properly fastened. All equipment shall be fastened in place with bolts.
- B. Keep all openings closed with plugs or caps to prevent entrance of foreign matter. Protect all piping, ductwork, fixtures, and equipment against dirt, water, chemical, or mechanical damage both before and after installation. Any equipment or apparatus damaged prior to final acceptance shall be restored to original condition or replaced at the Architect's discretion and at no additional cost to the Owner.
- C. Start-Up: Equipment shall be adjusted, lubricated, aligned, etc. prior to start-up. Inspect each piece of equipment prior to start-up. Start each piece of equipment in accordance with manufacturer's directions and warranty requirements.
- D. Finish: Protect all equipment and materials until in use. Any visible rust or corrosion shall be removed as directed prior to installation. All damaged factory painted finishes shall be cleaned and painted with manufacturer provided paint.

### 3.20 MANUFACTURER'S DIRECTIONS

- A. Materials and equipment shall be installed in accordance with manufacturer's application and recommendations, requirements, and instructions, and in accordance with Contract Documents. Where manufacturer's instructions differ from those indicated or specified, they shall be brought to Architect's attention for resolution prior to equipment ordering and installation.
- B. Where requirements indicated in Contract Documents exceed manufacturer's requirements, Contract Documents shall govern.

### 3.21 FURRING AND PIPE SPACES

- A. Spaces provided in the design of the building shall be utilized and the work shall be kept within the furring lines established on the Drawings.
- B. Layout: Maintain maximum head room under piping and equipment. Contractor to coordinate line locations with beams, windows, etc. to provide maximum clearance. From Drawings, ascertain heights of suspended ceilings and size of pipe shafts in which piping is concealed, and location and size of structural members in and adjacent to pipe shafts. Coordinate piping installation with ductwork, lighting, and other equipment. Ensure necessary clearances on trim plates at exposed penetrations of walls and floors. If sufficient room is not available above suspended ceiling or vertical shafts obtain clarification from Architect before work is started.

### 3.22 SEISMIC RESTRAINTS

- A. General: All work, materials and methods used shall conform to the Drawings and Specifications. NFPA 13 Guidelines shall be followed when specific details are not shown on the Drawings. Anchorage of equipment for which specific details are not shown on the

Drawings shall be adequate to resist the forces based on the required "CP" factor. Such anchorage shall be approved by the Architect, Structural Engineer, and DSA

- B. All supports shall be in accordance with NFPA 13 and 2019 CBC.
- C. Piping:
  - 1. Pipe bracing system shall conform to the Drawings and to Specification requirements hereinafter listed, or shall be a pre-approved manufacturer's system such as Tolco Seismic Bracing System, or approved equal.
  - 2. The Contractor shall submit Shop Drawings indicating the location of all seismic braces and provide a legend giving load information and model specifications prior to installation. Such prearranged system shall conform to requirements of the Specifications.
  - 3. Brace all pipes with 2 1/2" I.D. and larger in accordance with NFPA 13.
  - 4. Transverse bracings at 40'-0" on center maximum (minimum of one brace per direction of run).
  - 5. Longitudinal bracings at 80'-0" on center maximum (minimum of one brace per direction of run).
  - 6. Transverse bracing for one pipe section may also act as longitudinal bracing for the pipe section connected perpendicular to it, if the bracing is installed within 24" of the elbow or tee and is connected to the largest pipe.
  - 7. Do not use branch lines to brace main lines.
  - 8. Provide flexibility in joints where pipes pass through building seismic or expansion joints or where rigidly supported pipes connect to equipment with vibration isolators.
  - 9. At vertical pipe risers, support the weight of the riser at a point or points above the center of gravity of the riser wherever possible. Provide lateral guides at the top and bottom of the riser and at intermediate points not to exceed 30'-0" on center.
  - 10. Provide large enough pipe sleeves through walls or floors to allow for anticipated differential movements.
  - 11. Do not fasten one rigid piping system to two dissimilar parts of the building that may respond in a different mode during an earthquake (e.g., a wall and a roof).
  - 12. Cast iron piping systems are included in these requirements.
  - 13. All trapeze hangers shall be braced.

### 3.23 CLEAN-UP

- A. During the course of work under this Section, all rubbish, debris, surplus materials, tools, etc. resulting from this work shall be removed from work area and shall be disposed of off-site at the end of each working day. The Owner's premises shall be left clean and in a condition acceptable to the Architect.
- B. Clean all work installed under this Contract to satisfaction of Owner and submit documentation that each system has been cleaned and results witnessed by the Architect's representative.

### 3.24 ENGRAVED NAMEPLATES

- A. Furnish and install plastic laminated engraved nameplates in accordance with NFPA 13, the local Fire Marshal and DSA.

### 3.25 FINAL INSPECTION

- A. The Contractor shall furnish the Architect with certificates of final inspection and approval from the inspection authorities having jurisdiction.

### 3.26 GUARANTEE

- A. The Contractor shall guarantee the quality of all work and the quality of equipment and materials in accordance with the provisions of the General Conditions and Special Conditions. Should any defects occur during this period, the Contractor shall promptly repair or replace defective items as directed by the Architect, without cost to the Owner.

### 3.27 SITE VISITS BY ENGINEER

- A. Engineer's responsibility is limited to normal construction support services only, consisting of office consultation, site visits, and reports to the Architect at appropriate stages of construction such as rough-in, pre-final, and final. All costs incurred by the Engineer for additional site visits or office work required to complete the project as the result of incomplete coordination or supervision by the Contractor or the Mechanical Sub-Contractor shall be paid for by the Contractor.

### 3.28 OPERATING AND MAINTENANCE MANUALS

- A. Complete sets of bound instructions containing the manufacturer's operating and maintenance instructions in accordance with specification section 21 0500 Overhead Fire Protection System:
- B. Field Instructions: Upon completion of the work and at a time designated by the Owner the services of one or more competent Engineers shall be provided by the Contractor to instruct a representative of the Owner in the operation and maintenance of the systems. These field instructions shall cover all the items contained in the bound instructions and shall be of a sufficient length and detailed nature, in the Engineer's judgment, to insure safe and efficient operation.

\*\*\*\* END OF SECTION \*\*\*\*

## SECTION 21 0500

### OVERHEAD FIRE PROTECTION SYSTEM

#### PART 1 - GENERAL

##### 1.1 GENERAL

- A. The General Conditions, any Supplementary Conditions, Section 21 0000, Fire Protection General, and Division 1 are hereby a part of this Section as fully as if repeated herein.

##### 1.2 SCOPE

- A. Furnish all labor, materials, equipment and services required for and/or reasonably incidental to the completion of the complete hydraulic calculated sprinkler system per NFPA 13 and other governing agencies.

##### 1.3 WORK INCLUDED IN THIS SECTION

- A. Furnish all labor, materials, equipment and services required for and/or reasonably incidental to the completion of the following work:
1. Sprinkler riser sized by hydraulic calculation complete with as detailed on the drawings.
  2. Complete hydraulic wet-pipe automatic fire sprinkler system through all portions of the Cafeteria Building, the buildings is calculated for Light Hazard, plus 100 GPM total combined hose flow as shown on the drawings. The Kitchen is calculated for Ordinary Hazard, plus 250 GPM total combined hose flow as shown on the drawings.
  3. Complete hydraulic wet-pipe automatic fire sprinkler system through all portions of the New Student Commons Building, the buildings is calculated for Light Hazard, plus 100 GPM total combined hose flow as shown on the drawings.
  4. Complete hydraulic wet-pipe automatic fire sprinkler system through all portions of the Existing Administration Building, the buildings is calculated for Light Hazard, plus 100 GPM total combined hose flow as shown on the drawings.
  5. Sprinkler heads and piping are required at all areas shown on Architectural and/or Structural Drawings.
  6. Furnish and install alarm bell flow switch riser. See Drawing for location of riser. Alarm bell shall be located a minimum of 7'-0" above the ground.
  7. Prime and finish painting of portions of the fire protection system as required by the DSA, Architect or Rating Agency. See also Division 09, Painting.
  8. Conformance to all design requirements of the local Fire Marshal and the Rating Agency. Preparation of all required Shop Drawings and details for the approval and installation of the system.
  9. Coordination of installation of electrical conduit for supervisory systems. Provide all contacts required.
  10. Arranging for all required inspections by the local official and by the Rating Agency. Cost of all testing and of special inspections required by them.

#### **1.4 RELATED WORK UNDER OTHER SECTIONS**

- A. The following work is not in the work under this Section, but is covered in other Sections.
  - 1. Installation and connection of the electrical conduit for supervisory systems as shown on the Electrical drawings.
  - 2. Installation of the fire alarm systems as shown on the Electrical drawings.
  - 3. Installation of the underground fire service.

#### **1.5 CODE REQUIREMENTS**

- A. All work shall conform to the requirements of the applicable Federal, State and local building and safety codes, ordinances and regulations.
- B. Special attention shall be given to local fire regulations and the regulations of the local fire department and building department.
- C. Special attention shall be given to local rulings of the Rating Agency.
- D. Nothing in this Specification or on the Drawings shall be construed as permitting a departure from any applicable Federal, State or local building and safety code, ordinance or regulation, or from any requirements of the local fire department, building department and/or Rating Agency.

#### **1.6 RATING AGENCY**

- A. Whenever the words "Rating Agency" are used in this Specification, they shall mean the insurance underwriters.

#### **1.7 SUB-CONTRACTOR QUALIFICATIONS**

- A. This Contractor must be a C-16 Contractor, licensed by the State of California Contractor's Licensing Board. No portion of the fire protection system (performed on the job site) shall be subcontracted.
- B. All fire sprinkler installers shall be certified and registered in accordance with the Automatic Fire Extinguishing Systems Certification requirements of CCR, Title 19, Division 1, Chapter 5.5.

#### **1.8 SUBMITTALS**

- A. Submit for review, within fifteen (15) days after signing contract, the required number of copies of a complete list of materials proposed for use, including sizes, capacities, etc. See Division 1 for requirements. This list includes:
  - 1. Sprinklers.
  - 2. Piping.
  - 3. Fittings.
  - 4. Hangers and Bracing.
  - 5. Pressure Gauges.
  - 6. Sprinkler Head Cabinet.
  - 7. Valves.

8. Check Valves.
  9. Flow Switch.
  10. Seismic Loop
- B. Shop Coordination Drawings shall show all details and information required by NFPA 13, NFPA 14 and/or NFPA 24. In addition, all earthquake bracing (longitudinal and lateral) shall be shown. If unnecessary deviation from Drawings are made by Contractor which cause additional cost to the Owner, Contractor shall submit the changes to the Architect for compliance verification and the additional cost shall be borne by the Contractor
- C. Final Record Drawings shall be submitted in accordance with Paragraph A above and paragraph Record Drawings of this Section, showing exact dimensional locations of all underground piping and of all risers, mains and cross-mains
- D. On completion of the job, furnish the Architect with a copy of the "Contractor's Material and Test Certificate" (Part A and/or B), signed by the local Fire Marshal, and a copy of the Transmittal Letter sending the certificate to the Rating Agency and DSA.

#### **1.9 DESIGN OF SYSTEM**

- A. The riser locations are shown on the Drawings. Any request for changes must be submitted to the Architect 48 hours prior to bid times for consideration.
- B. All work shall be designed in accordance with the requirements of DSA, the Rating Agency, the latest editions of NFPA 13, 14, and 24 and the appropriate edition of the California Building Code and the California Fire Code (as modified by local ordinance or ruling).
- C. Each building's sprinkler system shall be hydraulically calculated for the hazards or commodity indicated in Section 1.4.
- D. Calculations shall be based upon the water supply available at the connection with the City water main.
- E. Calculations shall demonstrate the system has a design cushion of at least ten percent of the available static pressure, or as required by local authority if greater.
- F. The Sprinkler Contractor shall refer to the Architectural, Structural, Mechanical, and Electrical Drawings and coordinate the system layout to not interfere with the arrangement of lighting fixtures, grilles, diffusers, ductwork, equipment and piping in the Building.
- G. All piping shall be installed for routing as shown on Drawings, including cross-mains, if shown. Also, piping shall be installed as close as practical to the roof structure so as to provide the maximum possible clear height. Cross-mains shall follow the roof line (tight to the bottom of the beams, purlins or joints) so as to remain at an approximately constant distance from the roof throughout.
- H. Fire protection system lines shall be designed so as to avoid all other utility lines, conduit and structural components shown on the Drawings. Fire protection system lines must give way to all gravity lines. Notify Architect if conflicts cannot be coordinated in the field.

- I. Cutting structural members shall not be allowed, unless otherwise approved by the Structural Engineer or the Architect.

## **PART 2 - PRODUCTS**

### **2.1 MATERIALS**

- A. All materials shall be new and currently listed in the Underwriters' Laboratories, Inc. Fire Protection Equipment List and shall be acceptable to DSA. Material that is pending approval shall not be acceptable.
- B. Underground piping shall be installed in strict accordance with the manufacturer's installation guide.
- C. Cast or ductile iron shall be installed to within 5'-0" of building and under all footings and slabs.
- D. Above ground piping to be ANSI/ASTM A135 electric resistance welded and seamless carbon steel pipe. 1 1/2 in. and smaller use Schedule 40 with threaded fittings, 2" and greater shall be welded or roll grooved, minimum wall thickness for 300 psi in accordance with Schedule 10 up to 5 in., 0.134 in. wall for 6 in. pipe, and 0.188 in. wall for 8 in. and 10 in. pipe.
- E. Backfill shall be accomplished in strict accordance with the manufacturer's installation guide and the "Backfill" Section of these Specifications.
- F. Overhead piping, fittings and hanger material shall conform to the requirements outlined in NFPA 13.
- G. Chrome plated escutcheon plates shall be provided where sprinkler piping passes through walls, floors or ceilings.
- H. The escutcheons shall be the same size throughout the building and shall match ceiling decor.
- I. A metal box containing replacement sprinkler heads shall be mounted near the riser inside the building and shall contain at least 6 heads and at least 2 of each type of head installed in the building. Also included shall be one wrench for each type of head used in the building.
- J. Bushings shall not be used unless specifically approved by the Architect.
- K. Provide and install head guards on sprinkler heads in areas where they could be damaged (stairwells, mechanical rooms, electrical rooms, emergency generator rooms, etc.).
- L. Water flow switches shall be furnished and installed where indicated on the Drawings. Flow switch shall be UL rated by Notifier or approved equal. Flow switches shall be CSFM approved. Each switch shall have minimum of two poles for 120 V operation.
- M. Tamper-proof switches shall be 120 V tamper switches for each isolation and control valve in each area. Electrical wiring and annunciating. Tamper switches shall be CSFM approved.
- N. Remote inspector's Test station to be per NFPA 13, at location shown on Drawings. Test station to be provided with isolation valve and orifice equal to one sprinkler head flow, with drain to sanitary sewer.



## 2.2 HANGERS, INSERTS, AND SUPPORT

- A. General: Provide hangers, brackets, supports, anchors and related appurtenances as required to support all piping and equipment provided under this Section. Piping and equipment supports shall conform to DSA approved drawings.
- B. Piping supports shall conform to hanger details on DSA approved drawings and NFPA 13.
- C. Manufacturers: Tolco or approved equal.
- D. Floor Supports: Provide, where required, necessary floor supports for piping and equipment. Supports shall be fabricated from structural members or shall be masonry piers.
- E. Sway Bracing: Per NFPA 13, DSA approved drawings and details.

## 2.3 SPRINKLER VALVES

- A. Manufacturer: Selection based on Stockham, Stockham, Kennedy, Walworth or Lunkenheimer, only, unless otherwise noted. All valves must be submitted and meet rating as scheduled below. No foreign manufactured valves shall be used.
- B. Valve pressure not less than 175 PSIG, except drain valves.
- C. Main Drain Valves: 2" Nibco T-301-W, bronze body and trip, UL
- D. Riser Check Valve: Tyco CV-1 riser swing check valve.
- E. Riser Control Valve: Tyco BFV-300 indicating butterfly valve with two sets of factory spot (single pole double throw) switches.
- F. Inspectors Test Valve: Tyco 1 1/4" model F350 test and drain valve with 5.6K test orifice, shut-off valve and visual flow indicator.
- G. Gauges: 3 1/2", 0-300psi, Ashcroft type 1005P, XUL fire protection sprinkler service -gauge fitted with gauge valve shut-off, UL, FM approved.
- H. Combination Inspectors Test and Main Drain: AGF TestAnDrain Assembly 1 1/4" model 1011A test and drain valve with 5.6k test orifice, shut off valve and visual flow indicator.
- I. Air Release Valve: Potters PAV 1/2" NPT inlet x 1/2" MNPT outlet to drain, 5/64" orifice brass connection. UL listed, FM approved, automatic air release valve for sprinkler systems

## 2.4 HOSE VALVES

- A. Hose Valve: FPPI Angle Hose Valve, 300 psi rated 2 1/2" MNST hose thread outlet, with brass chain and cap or approved equal.

## 2.5 SPRINKLER HEADS

- A. Exposed Ceiling Construction:
  - 1. Quick Response: Exposed upright automatic glass bulb type, plain brass finish, equal to Tyco, TY-FRB.

2. Standard Response: Exposed upright automatic glass bulb type, plain brass finish, equal to Tyco, TY-B.
- B. Finished Ceiling: Contractor to check with Architect on color to have manufacturer paint cover plates.
1. Concealed: Concealed pendent automatic glass bulb type, equal to Tyco, "Royal Flush II".
  2. Recessed: Recessed pendent automatic glass bulb type, equal to Tyco, TY-FRB.
  3. Hard Ceiling: Pendent automatic glass bulb type equal to Tyco, TY-FRB with Tyco 401 style escutcheon.
  4. Cooler/Freezer: Dry pendent, quick response, standard coverage, equal to Tyco, DS-1.
- C. Sidewall Heads: Contractor to check with Architect on color to have manufacturer paint cover plates.
1. Recessed horizontal sidewall automatic glass bulb type equal to Tyco, TY-FRB.
- D. Special Heads, Combustible Concealed Space: Upright automatic glass bulb type, plain brass finish, equal to Tyco, CC3.
- E. All heads, except as noted, to have temperature rating at 200°F. Set head at and around heating devices suitable under normal operation to eliminate false alarm by generated heat.
- F. Submittal: Submit 2 of each type of sprinkler head, complete with canopy, for Architect's review prior to ordering heads.

## 2.6 ALARM RELATED COMPONENTS

- A. Electric Bell: Potter 10" PBA1210, UL, FM approved CSFM listed, or approved equal.
- B. Riser Flow Switch: Potter VSR vane type waterflow alarm switch with retard, UL, FM approved, CSFM listed, with (2) single pole adjustable switches.
- C. Shunt Trip Flow Switch: Potter VS-SP vane type waterflow alarm switch without retard, UL, FM approved, CSFM listed, with (2) single pole switches.

## 2.7 ACCESSORIES

- A. Sprinkler Cabinet: Tyco 12 head cabinet part number P/N 1124.
- B. Access Panel: 24" x 24" Croker FRPWB1865 fire rated access panel with 16 gauge steel door, continuous hinge and dry wall bead frame.

## 2.8 PRESSURE GAUGE

- A. 3 1/2" 0-300psi Ashcroft type 1005P, XUL fire protection sprinkler service gauge fitted with gauge valve shut-off, UL, FM approved.

## 2.9 SEISMIC JOINT

- A. Seismic Joint: Metraflex fireloop seismic loop joint MLUG80XX series sized as shown on the plans. Seismic joint shall allow for a minimum of +/- 6" of seismic movement.

## 2.10 EXPANSION PLATE

- A. Viking 12620 expansion plate to conceal 1" annular clearance around pendent head recessed escutcheons in suspended lay in ceilings.

## 2.11 HOSE VALVE AND HOSE ASSEMBLY

- A. Hose Valve: 1 1/2" UL listed cast brass angle valve for use with Croker 3000 Series hose rack assembly or approved equal, for use in Croker 1010 recessed hose cabinet or approved equal.
- B. Hose Rack Assembly: Complete UL listed hose rack assembly complete with 75 feet of poly lined hose, 1 1/2" cast brass coupling, 1 1/2" UL listed industrial fog nozzle, 1 1/2" cadmium plated escutcheon, red enamel UL listed pin rack, and 1 1/2" cast brass nipple, Croker series 3000 hose rack assembly or approved equal.

## PART 3 - EXECUTION

### 3.1 GENERAL REQUIREMENTS

- A. Prior to bid, visit the job site and familiarize with local conditions, including verification of the location of the existing utilities.
- B. The contractor shall field verify existing conditions and provide accurate shop coordination drawings for coordination with other trades in accordance with Division 1.
- C. All piping shall be installed in a manner acceptable to DSA.
- D. All piping shall be pressure tested and flushed according to the procedures set forth in NFPA 13, NFPA 14, and NFPA 24, and witnessed by the General Contractor, and the DSA Inspector of Record.
- E. All equipment installed under this Contract shall be properly thrust blocked and earthquake braced. This Contractor shall be responsible for the proper design and installation of the equipment and for satisfying DSA, CSFM and the Architect that these requirements have been met. Drawings shall show locations of earthquake bracing, both lateral and longitudinal.
- F. All equipment installed under this Contract shall be protected from external damage. This Contractor shall be responsible for the proper design and installation of the equipment, and for satisfying DSA, CFSM and the Architect that these requirements have been met. Shop Drawings shall show details of protective equipment.
- G. The Contractor shall furnish and install all sleeves required for his/her work where it passes through concrete. If sleeves are not installed, all penetrations shall be core drilled. All penetrations shall be approved by the Architect before drilling.
- H. This Contractor shall be responsible for any damage to other work caused by this installation or by leaks in the fire protection lines.
- I. This Contractor shall be responsible for coordinating his/her work with the General, Electrical, Mechanical, and Plumbing Contractors, and with other trades.

- J. All work shall be done in a neat and workmanlike manner. All heads to be located as shown in the fire protection ceiling plans, on center or quarter points of ceiling tiles unless otherwise noted. Location of sprinkler heads shall take note of obstructions.
- K. Escutcheons shall not be permitted closer than 6" to T-bar ceiling members if conflicts with lights or grilles do not permit the centering of the heads in the tiles. Architect shall have final approval on exact location of sprinkler heads. Escutcheons shall not be mounted closer than 6" to any other ceiling mounted device.

### **3.2 TOOLS**

- A. All special tools for proper operation and maintenance of the equipment provided under this Section shall be delivered to the Owner's representative and a receipt requested for same.

### **3.3 IDENTIFICATION**

- A. Valves:
  - 1. Riser control valve and floor control valves shall be clearly identified in the Riser Room.
- B. Piping Identification:
  - 1. Apply color coded polyvinyl chloride pipe bands identifying service per Section 21 00 00.
  - 2. On exposed piping, apply bands at 20'-0" on centers at straight runs, at valve locations, and at points where piping enters and leaves a partition, wall, floor, or ceiling.
  - 3. On concealed piping installed above removable ceiling construction, apply bands in manner described for exposed piping.
  - 4. On concealed piping installed above non-removable ceiling construction, or in pipe shafts, apply bands at valves or other devices that are made accessible by means of access doors or panels.
  - 5. Apply bands at exit and entrance points at each piece of equipment.
  - 6. Band widths shall be 8" for pipes up to 10" diameter, and 16" for larger diameter piping. Letter heights stating service shall be pre-printed on band, 3/4" high for 8" bands and 1 1/4" high for 16" bands.
  - 7. Colors shall conform to ASA Standard A13.1.
  - 8. Tags and bands shall be approved for this service
  - 9. Where flexible sprinkler hose fittings are installed and supported by suspended ceilings, the ceiling shall meet ASTM C 635 and ASTM C 636. Additionally, a label limiting relocation of the sprinkler shall be provided on the anchoring component. (NFPA 13-10, 9.2.1.3.3.2 & 9.2.1.3.3.4).

### **3.4 SPRINKLER DRAINS AND TEST CONNECTION**

- A. Provide all necessary drain valves, drain risers, capped nipples, auxiliary piping, etc. as required to drain the system risers and mains, and all trapped portions of the system. Drain valves which are not connected to drain pipes leading to floor drains shall be hose end type.

- B. Main drains and test connections shall be piped to sanitary sewer. Provide air gap at discharge location shown on the plans.
- C. Provide all piping required to spill the drains and test connections to the floor, funnel or other drainage connections provided under the plumbing contract, or arrange with the plumbing trade to provide additional drainage facilities, in which case pay all charges related to the additional plumbing construction work.

### **3.5 TAGS**

- A. Provide all designated signs on shut-off valves, control valves, alarms, etc. as required by the agencies having jurisdiction.

### **3.6 TESTING**

- A. All sprinkler system piping must be hydrostatically tested for a period of two (2) hours in the presence of the Owner or his/her designee, and the DSA Inspector of Record.
- B. Hydrostatic tests shall be made not less than 200psi for 2 hours or 50psi above static pressure in excess of 150psi.
- C. Leakage from any fittings may be corrected by tightening or replacement of defective materials only. Use of sealant materials is expressly prohibited and unacceptable to the Owner as a corrective measure.
- D. Gauges used in testing shall be identified as to accuracy, or provided by Owner, at his/her option.
- E. Blind flanges or inserts used for testing shall be placed in the system and removed from the system in the presence of the Owner or his/her designee. These devices shall be clearly marked and vividly painted to permit casual observance of their addition to the system.

### **3.7 RECORD DRAWINGS**

- A. Keep a current set of Record Drawings on the job at all times. These Drawings shall be updated as changes are made and shall be kept in the Construction Office. Also, see Special Conditions and Fire Protection General, Section 21 00 00.
- B. Keep a current set of Specifications and material lists, with catalog cuts, in the Construction Office at all times.

### **3.8 CLEAN-UP**

- A. Perform the work under this Section so as to keep affected portions of the site neat, clean and orderly at all times. Upon completion of the work under this Section, immediately remove all surplus materials, rubbish and equipment associated with or used in the performance of this work. Failure to perform such clean-up operations within 24 hours of notice by the Architect or General Contractor shall be considered adequate grounds for the work to be done by others at this Sub-Contractor's expense.

### 3.9 OPERATIONAL AND MAINTENANCE MANUALS

- A. Four (4) complete sets of operational and maintenance (O&M) booklets shall be supplied to the Architect with Record Drawings. One (1) set shall be retained by the engineer of record.
- B. O&M booklets shall be complete and include:
  - 1. Record/ As built drawings.
  - 2. Record/ As built hydraulic calculations.
  - 3. Material Data.
  - 4. System operation and maintenance instruction.
  - 5. Inspection and Testing Log.
  - 6. Current 2013 NFPA 25 California Edition (Based on NFPA-25 2011 Edition)

\*\*\*\* END OF SECTION \*\*\*\*

## SECTION 21 1000

### UNDERGROUND FIRE SERVICE

#### PART 1 - GENERAL

##### 1.1 GENERAL

- A. The General Conditions, any Supplementary Conditions, Section 21 0000, Fire Protection General, and Division 1 are hereby a part of this Section as fully as if repeated herein.
- B. Section Includes: Description of requirements for materials and installation of site utilities and related work as shown on Drawings and necessary to provide a complete and proper installation.
- C. The work includes under this section consists essentially of, but not necessarily limited to installing new site utilities in areas indicated on Drawings.

D. Related work:

Section 21 0000	<u>Fire Protection General</u>
Section 21 0500	<u>Overhead Fire Protection Systems</u>

##### 1.2 SCOPE

- A. Furnish all labor, materials, equipment and services required for and/or reasonably incidental to the completion of the following work:
  - 1. Connection to new private fire main shown on civil drawings five feet outside the new buildings with minimum 6" diameter sprinkler main.
  - 2. Underground fire sprinkler mains from five feet outside of new buildings, minimum 6" diameter, complete with in-building riser ending at a flange 12" above finish floor, with a blank flange bolted on top. Risers shall be located as shown on the fire protection drawings.
  - 3. Trenching and backfill for underground sprinkler main to five feet outside building.
  - 4. Backflow assembly, underground check valves, gate valves, post indicators, fire hydrants, and fire department connections beyond five feet outside of building shall be in accordance with Division 33.

##### 1.3 SUBMITTALS

- A. Submit for review, within fifteen (15) days after signing Contract, the required number of copies of a complete list of materials proposed for use, including sizes, capacities, etc. See Division 1 for requirements. This list includes:
  - 1. Piping.
  - 2. Fittings.
  - 3. Valves.
  - 4. Tracer wire.
  - 5. Warning tape.

6. In-Building Riser.
7. Polyethylene Encasement for Protection Against Corrosive Soil.
8. Mechanical Joint Restraint.

#### **1.4 COORDINATION**

- A. Before submitting a bid for the mechanical work the Contractor shall visit the site and become familiar with all the work on other related Drawings and Specifications, and plan his/her work to provide the best possible assembly of the combined work of all trades. No additional costs will be considered for work which has to be relocated due to conflicts with other trades.

#### **1.5 BUILDING LAWS**

- A. Mechanical work shall conform to all requirements prescribed by governmental bodies having jurisdiction and is to be in accordance with the Uniform Plumbing Code, California Mechanical Code, California Fire Code, National Fire Protection Association; California State Code Title 8, Title 21, and Title 24; and the Energy Conservation Standards.
- B. Should any part of the design fail to comply with such requirements, the discrepancy shall be called to the attention of the Architect prior to submitting a bid.
- C. Should there be any direct conflict between the Drawings and/or Specifications and the above rules and regulations, the rules and regulations shall take precedence. However, when the indicated material, workmanship, arrangement or construction is of a superior quality or capacity to that required by above rules and regulations, the Drawings and/or Specifications shall take precedence. Rulings and interpretations of enforcing agencies shall be considered a part of the regulations.
- D. After a Contract is awarded, if minor changes or additions are required by the aforementioned authorities, even though such work is not shown on Drawings or overtly covered in the Specifications, they must be included at the Contractor's expense.
- E. The Contractor is responsible to coordinate and make adjustments in his/her work with the full set of Contract Drawings and Specifications.

#### **1.6 PERMITS, FEES AND UTILITIES**

- A. The Contractor shall obtain and pay for all permits and fees. The Contractor shall arrange for all required inspections.

#### **1.7 UTILITY CONNECTIONS**

- A. The Contractor shall route site utilities to approximately 5'-0" outside of building, or as shown on Drawings.

#### **1.8 MATERIALS AND WORKMANSHIP**

- A. All equipment provided shall deliver full rated capacity at efficiency for which designed. All equipment shall meet requirements indicated and be suitable for installation shown. Notify Architect of any shortcomings found at least ten (10) days prior to bid date. Equipment not



- meeting all specified requirements will not be accepted even though specified by name along with other manufacturers.
- B. Where two or more units of the same class of equipment are furnished in the same Section of the Specification, provide each from the same manufacturer. Furnish all equipment and materials new and free from defects.
  - C. Capacities, dimensions or sizes specified or indicated are minimum. Tolerances used in rating or testing standards specified not allowed in determining capacities of equipment.
  - D. Materials and equipment shall be installed in accordance with the manufacturer's application recommendations, requirements, and instructions, and in accordance with Contract Documents. Where manufacturer's instructions differ from those indicated or specified, they shall be brought to Architect's attention for resolution prior to equipment ordering and installation. Where requirements indicated in Contract Documents exceed manufacturer's requirements, Contract Documents shall govern.
  - E. All non-metallic piping below grade shall have tracer wire and warning tape installed as part of this scope of work.

#### 1.9 SITE CONDITIONS

- A. Information on Drawings relative to existing conditions is approximate. During progress of construction, deviations found necessary to conform to actual conditions shall be reported to Architect for determination of procedure to be followed. Contractor is responsible for any damage caused to existing systems. Promptly notify Architect if utilities are found which are not indicated.
- B. Existing equipment, piping, wiring, construction of City sidewalk, street, etc. which interferes with work of this Section shall be removed and promptly returned to service. Replace damaged items with new material to match existing. The City of Cupertino and private utilities must be informed of property owned by them that has been damaged and replaced.
- C. Remove materials not required for present or future use of facility and not claimed by Owner shall become the property of the Contractor and shall be removed from the premises. Consult Owner before removing any material from the premises. Materials claimed by the Owner shall be removed carefully to prevent damage and delivered on-site where directed.
- D. Existing piping and wiring not reused and concealed in building construction may be abandoned in place, but all such piping and wiring which is exposed or indicated to be removed shall become the property of the Contractor and shall be removed from the premises.
- E. Verify all dimensions, lines, and levels at the site for all work specified herein. All inverts, slopes, and elevations shall be established by instrument working from established datum. Provide elevation markers and lines for Owner's use in determining that slopes and elevations are in accordance with contract requirements. Accurately locate trenches in relation to building and boundary lines as indicated.

## **PART 2 - PRODUCTS**

### **2.1 PIPING AND MATERIALS**

- A. Fire and sprinkler mains to 5'-0" from the building shall be Manville "Blue Brute" PVC, FM Class 200, DR14, "Certainteed" C900, or approved equal, with ringtite joint for 4" or larger. Lubricate per manufacturer's recommendations (see Thrust Block detail). For 3" and smaller, Schedule 40 PVC pipe with solvent joints (rated at 200 PSI fittings).
- B. Tracer wire for all non-metallic piping shall be minimum size #10 AWG copper wire with U.L. approval for direct-burial with an insulating jacket of Yellow Color. Piping shall have a contiguous trace wire strapped to the pipe every 5 lineal feet and shall be accessible at every riser and in-grade valve box. Contractor shall provide both warning tape and trace wire for all underground piping.
- C. All fire and sprinkler service materials shall be new and currently listed in the Underwriters' laboratories, Inc. Fire Protection Equipment List and shall be acceptable to DSA. Material that is pending approval shall not be acceptable.
- D. All underground piping shall be installed in strict accordance with the manufacturer's installation guide.
- E. Sprinkler mains shall be cement lined class 50 ductile iron when installed to within 5'-0" of building and under all footings and slabs.
- F. All metallic piping fittings shall be coated and wrapped. Metallic piping and fittings shall be polyethylene encased for corrosive soil conditions.
- G. All bolt-up sets (nuts, bolts, and washers) and tie rods for valves, fittings, and buries shall be stainless steel, ASTM A-276 Type 316.
- H. Backfill shall be accomplished in strict accordance with the manufacturer's installation guide and the "Backfill" Section of these Specifications.
- I. Tamper-proof switches shall be 120 V tamper switches for each isolation and control valve in each area. Electrical wiring and annunciating. Tamper switches shall be CSFM approved.
- J. In-Building Riser: Ames series IBR, 304 stainless steel, UL/FM approved.

### **2.2 VALVE BOXES**

- A. Valve boxes shall be of cast iron, screw adjustable type with loose cast iron cover as manufactured by M&H, Mueller, Iowa or Pacific States Cast Iron. Covers shall be lettered "Water" or as detailed and specified on Drawings.

### **2.3 THRUST BLOCKS**

- A. Provide concrete thrust blocks at all changes in direction of fire and fire sprinkler main. Minimum face area against undisturbed soil shall be 6 ft<sup>2</sup> on water mains, or as indicated; 1/2" diameter rods shall be bent around pipe and anchored into 2000 lbs. strength concrete. Thrust blocks shall be provided in addition to mechanical joint restraint per local fire marshal.

## **2.4 MECHANICAL JOINT RESTRAINT**

- A. Provide mechanical joint restraint at all changes in direction of the fire and fire sprinkler mains. Mechanical joint restraint for C900 PVC pipe shall be EBAA Iron Megalug series 2000PV or approved equal. Mechanical joint restraint for ductile iron pipe shall be EBAA Iron Meglug series 1100 or approved equal.

## **2.5 VALVES**

- A. All valves shall be the product of a single manufacturer, Mueller, Stockham, Kennedy or Clow. Valves shall be mechanical joint and be AWWA approved.

## **2.6 POLYETHYLENE ENCASEMENT**

- A. All metallic pipe fittings and appurtenances below grade shall be encased for protection from corrosive soil with a minimum of 8 mil polyethylene fitting wrap in accordance with ANSI/AWWA C105/A21.5-10. Polyethylene fitting wrap shall be Christy's Fitting Wrap or approved equal.

## **2.7 MASTIC**

- A. All metallic pipe fittings and appurtenances below grade shall be coated for protection from corrosive soil with a minimum of 18 mil with bituminous coal tar mastic. Christy's HD 50 Bituminous Coal Tar Mastic or approved equal.

## **PART 3 - EXECUTION**

### **3.1 GENERAL REQUIREMENTS**

- A. Prior to bid, visit the job site and familiarize with local conditions, including verification of the location of the existing utilities.
- B. All fire and sprinkler piping shall be installed in a manner acceptable to the local CFSM and DSA and the Rating Agency.
- C. All fire and sprinkler piping shall be pressure tested and flushed according to the procedures set forth in NFPA 13, NFPA 14, and NFPA 24, and witnessed by the General Contractor and the DSA Inspector of Record.
- D. This Contractor shall be responsible for any damage to other work caused by this installation or by leaks in the fire protection lines.
- E. This contractor shall be responsible for coordinating his/her work with the General, Electrical, Mechanical, and Plumbing Contractors, and with other trades.

### **3.2 EXCAVATION AND BACKFILL**

- A. Perform all necessary excavation and backfill required for installation of mechanical work. Any work damaged during excavation and backfilling shall be repaired at Contractor's expense.

- B. Trenches are to be excavated to necessary depth and width. Provide additional excavation to facilitate crossovers, additional offsets, etc. as required. Excavation material is unclassified. Width of trench adequate for proper installation of piping.
- C. Bedding shall be on minimum 6" deep layer of sand placed on leveled trench bottom. Sand removed to necessary depth for piping bells and couplings to maintain contact of pipe on sand for entire length. All other piping laid on smooth level trench bottom to maintain contact for entire length.
- D. All backfill shall be bank run sand and/or gravel to 6" above piping up to slab on interior piping below slabs. All backfill placed in layers not exceeding 8" deep and compacted to 95% of maximum density at optimum moisture content per AASHTO Standard T-99.
- E. During progress of work, Owner may have compaction tests made under direction of testing laboratory for all compacted fill. If found not to meet Specification, Contractor shall excavate and recompact fill at no additional cost to Owner.
- F. Following backfilling, grade all trenches to level of surrounding subgrade. All excess soil shall be located per Owner's instructions.

### **3.3 CORROSION PROTECTION**

- A. All metallic piping fittings, bolts etc. shall be coated with a minimum of 18 mils of bituminous coal tar mastic and then wrapped with a minimum of 8 mils of polyethylene fitting wrap for corrosive soil conditions.
- B. All bolt-up sets (nuts, bolts, and washers) and tie rods for valves, fittings, and buries shall be stainless steel, ASTM A-276 Type 316.

### **3.4 SETTING OF THRUST BLOCKS**

- A. Thrust Blocks: Plugs, caps, tees, and bends deflecting 22 1/2° or more, either vertically or horizontally, on water lines 4" in diameter or larger and fire hydrants shall be provided with thrust blocking. Thrust blocking shall be concrete of a mix not leaner than 2 parts cement; 2 1/2 parts sand; 5 parts gravel; and having a compressive strength of not less than 2,000 PSI at 28 days. Blocking shall be placed between solid ground and the hydrant or fitting to be anchored. Unless otherwise indicated or directed, the base and thrust bearing sides of thrust blocks shall be poured directly against undisturbed earth. The sides of thrust blocks not subject to thrust may be poured against forms. The area of bearing shall be as shown or as directed. Blocking shall be placed so that the fitting joints will be accessible for repair.

### **3.5 REQUIREMENTS OF REGULATORY AGENCIES**

- A. In addition to requirements shown or specified, comply in general with applicable portions of latest current local and/or State ordinances and codes.
- B. Include all items of labor and material required to comply with such standards and codes. Where quantities, sizes or other requirements indicated are in excess of standard or code requirements, specified requirements shall govern.

### 3.6 COORDINATION

- A. Do all work to receive or joint with work of all trades; cut new service into existing mains; extend piping; and make necessary connections as required to prevent interruption of service. All work shall be coordinated with work of other trades to provide clearances for installation and maintenance of all mechanical equipment. Drawings and Specifications are arranged for convenience only and do not necessarily determine which trades perform various portions of the work.
- B. Before shutdown of any utility service for new connections, coordinate with and notify Owner, County, and utility company(s). Contractor to verify with Architect for approval for areas of interference with existing facilities and operation of departments before doing any work. Contractor to work out schedule of construction and get approval by Architect before starting any work.

### 3.7 DRAWINGS

- A. Drawings are diagrammatic and do not show all offsets, bends, elbows, etc. which may be required for proper installation of work. Such work shall be verified by Contractor at building site. Provide additional bends and offsets as required by riser and main locations, or other conditions, to complete work at no additional cost to Owner.
- B. Drawings and Specifications are complementary and what is called for by one shall be as binding as if called for by both. Items indicated are not necessarily included in Specifications. Specifications shall supersede Drawings in case of conflict.

### 3.8 TESTING

- A. Test all piping, valves, etc. as listed below and provide the DSA Inspector of Record with Contractor Material Test Certificates in accordance with NFPA24 test results. The inspection authority having jurisdiction and the supervising Architect shall be notified at least 24 hours prior to performance of all tests so that they may be witnessed.
  - 1. All new fire main piping shall be hydrostatically tested to 200 PSI for 2 hours in the presence of the contractor and DSA Inspector of Record.
  - 2. After pipe flushing and hydrostatic testing is completed the installing contractor shall provide the DSA Inspector of Record the completed underground Contractor's Material Test Certificate in accordance with NFPA24-10.10.

**END OF SECTION**

## SECTION 22 0000

### PLUMBING

#### PART 1 GENERAL

##### 1.01 SECTION INCLUDES

- A. The Bidding Requirements and Contract Forms, including General Conditions and Supplemental General Conditions, and Division 01 Sections apply to all work herein.

##### 1.02 SUMMARY

- A. Section includes: Furnishing, fabrication, and installation of complete plumbing systems as indicated on the Drawings. Plumbing work includes, but is not necessarily limited to, the following items:
  - 1. A complete system of soil, waste, vent and sanitary sewer piping and structures, including provisions for mechanical equipment drainage; and connection of same to existing soil, waste, vent and sanitary sewers, located approximately as indicated on the Drawings
  - 2. Cold water distribution system, complete, from points of contact with site domestic water systems, located approximately as indicated on the Drawings, to all plumbing fixtures, mechanical equipment, building specialties, and Owner supplied equipment scheduled for service on the Drawings.
  - 3. Hot water distribution system, complete, from serving water heaters and/or points of contact with site domestic hot water, to all plumbing fixtures, mechanical equipment, building specialties, and Owner supplied equipment scheduled for service on the Drawings.
  - 4. Natural gas piping system, complete from point of connection with site gas piping (located approximately as indicated on the Drawings) and terminating in stopcocks adjacent to all gas-fired equipment, as noted on the Drawings.
  - 5. Rough-in and connection of all plumbing fixtures and trim as scheduled on the Drawings and as furnished by Owner, inclusive of setting of fixtures and connections to drainage and water supply systems.
  - 6. Pipe wrapping and insulation.
  - 7. Flashing of all plumbing pipe penetrations through exterior walls, roofs, and foundations.
  - 8. Excavation and backfill as required for the work of this Section in conformity with Division 31 of these Specifications.
  - 9. Final connection of water and natural gas to equipment furnished under other Sections.
  - 10. Condensate drainage piping and connections from points of attachment to equipment to indirect waste locations, as noted on the Drawings.
  - 11. Storm water drainage systems within the building, inclusive of roof drains and copper, steel, or cast iron storm water leaders, to points of contact with site drainage system
  - 12. Protection of all piping specified herein and/or shown on the Drawings, from freezing. Buried piping shall be a minimum of 12" below the local frost line. If ambient design temperature is 30°F or less, all pipes in unconditioned spaces shall be insulated.
  - 13. Testing and adjusting of all piping systems and equipment herein specified.
  - 14. Sterilization of domestic water systems.
- B. The Contractor shall provide all supervision, labor, materials, transportation, equipment, hauling and services necessary for a complete and operational system, unless otherwise noted. Anything accepted as standard trade practice reasonably incidental to the completion of the plumbing systems, such as offsets, fittings, etc., even though not specifically shown on Drawings or indicated in Specifications, shall be furnished without additional cost to the

Owner. The Contractor shall understand that the work herein described shall be complete in every detail, notwithstanding every item necessarily involved is not particularly mentioned, and the Contractor shall be held to provide all labor and material necessary for the entire completion of the work.

### 1.03 RELATED WORK SPECIFIED IN OTHER SECTIONS

- A. Sealants, Firestopping, Sheet Metal Flashing and Trim: Division 07.
- B. Sheet Metal Storm Water Leaders, Downspouts, and Gutters: Division 07.
- C. Basic Electrical Requirements, Line Voltage Wiring: Division 26.
- D. Water Service, Meter, and Piping in connection with Landscape Irrigation System: Division 32.
- E. Finish Painting: See Division 09 for painting requirements.
- F. Excavation and Backfill: Division 31, Earth Moving Section
- G. Concrete and Grout: Division 03, Cast in Place Concrete Section

### 1.04 QUALITY ASSURANCE

- A. Regulatory compliance: All work performed under this Section shall comply with the latest currently adopted editions of all codes and regulations and all requirements of all Authorities having Jurisdiction.
- B. Codes and Standards: Conform to the latest edition of all applicable codes and standards stated herein and as described in Division 01 of the Specifications, including the following:
  - 1. California Mechanical Code
  - 2. California Plumbing Code
  - 3. California Building Code
  - 4. California Fire Code
  - 5. California Green Building Code
  - 6. California Electric Code
  - 7. California Code of Regulations, including Titles 8, 17, 19, 20, 21, 22 and 24
  - 8. Comply with all ADA and California Title 24 requirements for disabled access.
  - 9. NSF/ANSI 61 Standard, Drinking Water System Components - Health Effects for fixture materials that will be in contact with potable water.
  - 10. AB 1953, Amendments to Section 116875 of the Health and Safety Code relating to lead plumbing.
- C. Minimum requirements: The requirements of these are the minimum that will be allowed unless such requirements are exceeded by applicable codes or regulations, in which the regulatory codes or regulation requirements shall govern.
- D. When the Contract Documents call for materials or construction of a higher standard than is required by the above, the Contract Document requirements shall take precedence over the requirements of the said laws, rules, and/or regulations, accepting that nothing in the Contract Documents shall be interpreted as permitting work in violation of said laws, rules, and/or regulations. The Contractor for this work shall furnish any additional materials and/or labor as may be required for compliance with these laws, rules, and/or regulations though such materials and/or labor are not specifically set forth in the Contract Documents, with no additional charges to Owner.
- E. Seismic construction and restraints shall be in accordance with the requirements of the California Building Code and Title 17 and Title 24 of the California Code of Regulations. All equipment mounts, isolators, and hanging systems must meet DSA approval requirements.

- F. Comply with the Safety Orders issued by Cal-OSHA and any other regulations of the State of California and any districts having jurisdictional authority.

### 1.05 SUBMITTALS

- A. All submittals shall be submitted under the provisions of Division 01 and the following.
  - 1. Product Data: for each type of product.
    - a. Submit cut sheets for each plumbing fixture. Include selected fixture and trim, fittings, accessories, appliances, appurtenances, equipment, and supports and indicate materials and finishes, dimensions, construction details, and flow control rates for each fixture indicated.
    - b. Submit manufacturer's product data for all plumbing piping, fittings, materials, and equipment.
  - 2. Shop Drawings:
    - a. Prepare complete consolidated and coordinated layout drawings for all new systems, and for existing systems that are in the same areas. Shop drawings shall be prepared using AutoCAD 2014 or newer and shall be drawn at a minimum  $\frac{1}{4}'' = 1' - 0''$  scale. Sections, details, and diagrams shall be to required scales for specified areas. Include diagrams for all piping, and power, signal and control wiring.
    - b. Complete and detailed shop drawings shall be maintained throughout the coordination and construction phase, indicating all equipment and trades' work clearly. All equipment including piping, etc. shall clearly identify both top and bottom elevations as well as distances from equipment to established building lines. Coordinate with other trades and field conditions and show dimensions and details including building construction and access for servicing.
    - c. Use of contract documents for shop drawings is not acceptable.
    - d. Submit shop drawings to Architect for approval prior to fabrication or installation of any work. Do not install equipment or piping until layout drawings have been approved. Any work installed without prior shop drawing approval shall be removed at the Contractor's expense.
  - 3. Welding Procedures
    - a. Before any welding is performed, the contractor shall submit to the Architect, copies of any welding procedure specifications and their supporting procedure qualification records for review and acceptance. Copies of welder qualification records shall be made available for review to the owner or his representative at the construction site.
    - b. Welding certificates
  - 4. As-Built Drawings
    - a. A complete set of Contract Drawings shall be maintained at the work site, and all changes in the work shall be recorded on this set on a daily basis. In addition to changes made during course of work, show the following:
      - 1) Exact location, type and function of concealed valves and controllers.
      - 2) Exact size, elevations and location of underground and under floor piping.
    - b. Submit to Architect for approval.
  - 5. Operation & Maintenance Data
    - a. Contractor shall provide all operating and maintenance instructions provided by the manufacturer, describing proper operation and maintenance of any equipment and devices installed. Operating and maintenance instructions shall cover maintenance, adjustment, and operation of each piece of apparatus, including preventative maintenance schedule and procedures.
    - b. Contractor shall also provide a parts list of all equipment and component parts for all equipment under this Section. The equipment list shall include manufacturer's



name, model number, and local representative, service facilities and normal channel of supply for each item.

- c. Also include the following:
  - 1) Manufacturer's certified shop drawings, and lubrication charts and data. Mark each sheet with equipment identification number and actual installed condition or system and location of installation. Specifically identify which options are provided.
  - 2) Description of start-up and operating procedures for each system. including controls diagrams and description of operating sequences.
  - 3) Recommend preventative maintenance schedule and procedures.
  - 4) Provide copy of valve schedules for each piping system to include in maintenance manuals.
  - 5) Provide copy of equipment label schedule to include in maintenance manuals.
- d. Submit data to the Architect for approval. Final acceptance of the work will not be made until a satisfactory submission of this material is received and approved by the Architect.

#### **1.06 ACCURACY OF DATA**

- A. The data given herein and on the Drawings are as exact as could be reasonably secured, but absolute accuracy is not guaranteed. Exact locations, distances, elevations, etc. will be governed by shop drawings, the building itself, and actual field conditions.

#### **1.07 UTILITY CONNECTIONS**

- A. Provide all services within the building to a point five feet outside of building. Arrange for all utility connections, determine their exact requirements, and pay all costs incurred unless indicated otherwise.
- B. Send proper notices, make necessary arrangements, and perform other services required for care and maintenance of all utilities and assume all responsibility concerning same. Observe all rules and regulations of the respective utilities in executing the work.

#### **1.08 DAMAGE BY LEAKS**

- A. Contractor shall be responsible for any damage to work of other Contractors that is caused by leaks in any temporary or permanent piping systems due to pipe rupture, disconnected pipes or fittings, or by overflow of equipment.

#### **1.09 WARRANTIES**

- A. In accordance with Division 01 and as follows:
  - 1. Equipment warranties shall be provided for all equipment, with all necessary information filled in, except purchase date, in favor of the Owner.
  - 2. Provide new materials, equipment, apparatus and labor to replace that determined to be defective or faulty.

#### **1.10 LICENSING REQUIREMENTS**

- A. All plumbing systems shall be installed by a C-36 Plumbing Contractor. Plumbing systems include: waste removal and connection of on-site waste disposal systems; piping, storage tanks, and venting for supply of gases and liquids for any purpose; all gas appliances, flues, and gas connections; water and gas piping from the owner's side of utility meter to the structure or fixed works; installation of any type of equipment to heat water or fluids to a suitable

temperature; and maintenance and replacement of the items described above, including health and safety devices.

## **PART 2 PRODUCTS**

### **2.01 PRODUCTS CRITERIA**

- A. Only specified materials shall be utilized in the work of this Section unless substitutions have been approved in accordance with the General Conditions and Division 01 Sections of these Specifications.
- B. All materials, appliances, and equipment shall be new and best of their respective kinds, free from defects, and of the latest design.
- C. Multiple Units: When two or more units of materials or equipment of the same type or class are required, these units shall be products of one manufacturer.
- D. All fixtures, materials, and equipment equal in quality and utility to these herein mentioned will be accepted. When specific names are used in describing fixtures, materials, and equipment they are mentioned as standards only, but this implies no right on the part of the Contractor to use other fixtures, materials and equipment, or methods, unless approved as equal in quality and utility by the Architect. The decision of the Architect shall govern as to what fixtures, materials, and equipment are equals to those mentioned, but the burden of proof as to the quality of any proposed fixtures, materials, or equipment shall be upon the Contractor. If any tests are necessary to determine the quality of proposed fixtures, materials, or equipment, an unbiased laboratory shall make such tests at the expense of the Contractor. The chosen laboratory shall be satisfactory to the Architect.

### **2.02 PIPE, FITTINGS**

- A. General
  - 1. Tracer wire shall be installed with all non-metallic piping below grade. Tracer wire shall be solid core copper, 14 gauge minimum, laid continuously along pipes. Wire shall be "ty-wrapped" to pipe at eight feet on center. Tracer wire shall terminate in concrete access boxes at the beginning and terminal ends of the buried pipe.
  - 2. All accessible pipe 2" and smaller shall be threaded. Fittings for threaded pipe shall be 150-lb. malleable iron, screwed and banded.
  - 3. Vent piping shall have vandal resistant mushroom vent caps.
  - 4. At penetrations through building walls, provide link seal around pipe.
- B. Below Grade Sanitary Soil, Waste, Drain, and Vent Piping
  - 1. Below grade piping shall be of standard weight, no-hub cast iron soil pipe and fittings and shall conform to the requirements of CISPI Standard 301 and ASTM A 888 (latest editions). All pipe and fittings shall be manufactured in the United States and shall be marked with the collective trademark of the Cast Iron Soil Pipe Institute® and listed by NSF® International. Approved manufacturers: AB&I, Charlotte and Tyler Pipe.
  - 2. Joints for hubless pipe and fittings conform to the manufacturer's installation instructions and local code requirements.
  - 3. Hubless couplings shall be composed of stainless steel shields, clamp assemblies and elastomeric sealing sleeve conforming to CISPI Standard 310, latest edition. Heavy/Medium duty no-hub couplings shall conform to the requirements of ASTM 1540. Hubless coupling gaskets shall conform to ASTM C564. Couplings 1-1/2" through 4" shall have 4 bands.

- a. Piping 2" and smaller: Heavy/Medium duty no-hub couplings. Anaco/Husky "HD 2000", Ideal-Tridon Heavy Duty "HD", Charlotte Heavy Duty "MD" or Mission "Heavyweight".
  - b. Piping 2 1/2" or larger: Heavy/Super Duty type: Husky SD 4000 or Charlotte Heavy Duty "HD".
  - c. Couplings shall be installed in accordance with manufacturer's installation instructions and local code requirements and shall be tightened using a calibrated torque wrench. The clamps shall be tightened between 115 and 125-inch pounds.
- C. Below Grade Waste, Drain, and Vent Piping: If the native soil on this project is found to be of the highly corrosive nature, no steel or cast iron pipe shall be used below grade.
1. Solid wall schedule 40 PVC/DWV with drainage pattern, solvent welded fittings meeting the requirements of ASTM D2665
  2. PVC socket fittings: ASTM D2665, made to ASTM D3311, drain, waste and vent patterns and to fit Schedule 40 pipe.
  3. Joints shall be made in a two-step process with primer conforming to ASTM F656 and solvent cement conforming to ASTM D2564. .
- D. Above Grade Waste, Drain, and Vent Piping:
1. Lines 2" and larger shall be of standard weight, no-hub cast iron soil pipe and fittings and shall conform to the requirements of CISPI Standard 301 and ASTM A 888 (latest editions). All pipe and fittings shall be manufactured in the United States and shall be marked with the collective trademark of the Cast Iron Soil Pipe Institute® and listed by NSF® International. Approved manufacturers: AB&I, Charlotte and Tyler Pipe.
  2. Joints for hubless pipe and fittings shall conform to the manufacturer's installation instructions and local code requirements. Hubless couplings shall be composed of stainless steel shields, clamp assemblies and elastomeric sealing sleeve conforming to CISPI Standard 310, latest edition. Heavy/Medium duty no-hub couplings shall conform to the requirements of ASTM 1540. Hubless coupling gaskets shall conform to ASTM C564. Couplings 1-1/2" through 4" shall have 4 bands.
    - a. Piping 2" and smaller: Heavy/Medium duty no-hub couplings. Anaco/Husky "HD 2000", Ideal-Tridon Heavy Duty "HD", Charlotte Heavy Duty "MD" or Mission "Heavyweight".
    - b. Piping 2 1/2" and larger: Heavy/Super duty no-hub couplings. Anaco/Husky 4000, Charlotte Heavy Duty "HD" or equal.
    - c. Couplings shall be installed in accordance with manufacturer's installation instructions and local code requirements. The clamps shall be tightened using a calibrated torque wrench
  3. Lines under 2" shall be galvanized steel pipe, with threaded cast iron drainage fittings.
  4. At the option of this Contractor, all soil, waste, and vent piping above ground may be DWV copper, with wrought copper fittings, with "Stay-Safe 50" lead free solder or equal, and a suitable non-corrosive flux.
- E. Natural gas Pipe:
1. Above ground piping shall be Schedule 40, black steel. ASTM A-53-84A, electric resistance welded or seamless, Grade B
    - a. All concealed pipe and all pipe 2 1/2" and larger shall be welded. Fittings for welded pipe shall be seamless steel, weld neck.
    - b. All accessible pipe 2" and smaller shall be threaded. Fittings for threaded pipe shall be 150-lb. malleable iron, screwed and banded.
  2. Piping exposed to weather: Schedule 40 galvanized steel pipe and fittings. All exposed threads shall be primed with one coat of rust inhibiting paint.
- F. Below Grade Natural Gas Pipe:

1. Below Grade Gas Pipe: Performance Pipe, "DriscoPlex 6500" PE2406 polyethylene pipe and fittings for underground gas distribution. The polyethylene plastic pipe and heat fusion fittings shall meet the requirements of ASTM D 2513.
  2. The pipe and fitting manufacturer shall be ISO Certified in accordance with the current edition of ISO 9001 and a documented quality management system that defines product specifications and manufacturing and quality assurance procedures that assure conformance with customer and applicable regulatory requirements.
  3. A licensed and bonded Contractor shall perform all underground gas distribution piping construction work. The Contractor shall secure all necessary permits before commencing construction.
  4. Materials used for the manufacture of polyethylene pipe and fittings shall be PE 2708 (PE2406) medium density polyethylene meeting cell classification 234373E per ASTM D 3350; and shall be Listed in Plastic Pipe Institute TR-r with standard grade HDB ratings of 1250 psi at 73°F, and 1000 psi at 140°F. All pipe and fittings materials shall be opaque yellow in color. Materials shall be stabilized against ultraviolet deterioration and suitable for outdoor storage for at least 4 years.
  5. Heat Fusion Joining:
    - a. Butt, socket, and saddle fusion joints in polyethylene gas piping shall be made using procedures that have been qualified and approved by the Operator in accordance with Title 49, CFR, and Part 192.283.
    - b. In accordance with CFR 49, part 192, Section 192.85, the Operator shall ensure that all persons making heat fusion joints have been qualified to make joints in accordance with the Operator's Approved Qualified Fusion Procedures. The Operator shall maintain records of qualified personnel and shall certify that qualification training was received not more than 12 months before commencing construction. The Contractor shall ensure that all persons making heat fusion joints are qualified in accordance with these requirements.
    - c. Butt fusion of unlike wall thickness shall be performed between pipe ends, or pipe ends and fitting outlets that have the same outside diameter and are not different in wall thickness by more than one Standard DR. Transitions between unlike wall thickness greater than one SDR shall be made with a transition nipple or by mechanical means or electrofusion.
  6. Joining by Other Means: All transitions from PE to steel pipe shall be made with pre-manufactured transition fittings, Central Plastics "Victaulic Double 'O' Seal", or equal.
- G. Hot & Cold Water Piping:
1. All domestic hot, cold and tempered water piping 3" and smaller shall be Type L, hard temper, copper pipe with wrought copper or cast brass solder joint fittings. Pipe shall be NSF 61 Certified and bear the NSF Certification mark. All joints shall be made up with lead free solder. A suitable non corrosive flux shall be used at all joints. Mueller Streamline, Cerro Flow, or equal.
  2. All joints shall be made up with lead free solder. A suitable non corrosive flux shall be used at all joints.
    - a. Solder: ASTM B32. Harris "Staysafe Bridgit", Lucas Milhaupt "Silvabrite 100", or equal.
    - b. Flux: ASTM B813. Oatey Jet Flux, LA-CO Regular Soldering Flux, or equal.
  3. Press fittings shall also be acceptable:
    - a. Viega "Copper Press" or Nibco "Pressystem" fittings or approved equal. Copper and copper alloy press fittings shall conform to material requirements of ASME B16.18 or ASME B16.22 and performance criteria of IAPMO PS 117. Sealing elements for press fittings shall be EPDM. Sealing elements shall be factory installed or an alternative supplied by fitting manufacturer. Press end shall have SC (Smart Connect) feature design (leakage path).

4. Pipes below grade inside buildings shall be soft drawn, Type L or K copper with no joints below slabs. Pipes shall be sleeved with 20-mil plastic sheathing.
- H. Condensate Drainage Pipe: Mueller Streamline, Cerro Flow, or equal.
  1. 1 ¼" and larger shall be type DWV, drawn temper seamless copper tube, ASTM B306 with wrought copper or cast brass fittings. Wrought copper fittings shall comply with ASME B16.29.
  2. 1" and smaller shall be type M, drawn temper, seamless copper tube, ASTM B88 with standard pressure fittings.
- I. Indirect Waste Piping: Shall be Type M, hard temper, copper with wrought copper or cast brass fittings. Joints shall be made up with lead free solder, ASTM B32. Harris "Staysafe Bridgit", Lucas Milhaupt "Silvabrite 100", or equal.

### 2.03 VALVES, SPECIALTIES

- A. General Requirements:
  1. All valves, except pressure reducing and control valves, shall be the same size as the pipe to which they are installed.
  2. All valves of a particular type and size range shall be the product of one manufacturer.
  3. Valve body materials shall be compatible with piping system materials.
  4. Provide a union immediately downstream from each valve, unless the valve is flanged.
  5. All valves shall be installed with the stem 45 degrees above horizontal, if possible. In no case shall the stem be installed below horizontal.
  6. Where insulation is indicated, install extended stem valves arranged in proper manner to receive insulation.
- B. Ball Valves
  1. Threaded: Nibco T-685-80-LF, Watts LFB-6080, or KITZ 858; lead-free, bronze alloy, 2-piece body, full port, blowout proof stem; MSS SP-110; NSF/ANSI-61-8 and NSF/ANSI-372; 600 PSI non-shock cold working pressure.
  2. Solder: Nibco S-685-80-LF, Watts LFB-6081, or KITZ 859; lead-free, bronze alloy, 2-piece body, full port, blowout proof stem; MSS SP-110; NSF/ANSI-61-8 and NSF/ANSI-372.
- C. Gate Valves:
  1. 3" and smaller: Nibco T134, Stockham B-120, or KITZ 42T; bronze body, union bonnet, rising stem, solid wedge, 150 lb. with wheel handle.
  2. Larger than 3": Nibco F-617-0 or KITZ 72; iron body, bolted bonnet, outside screw and yoke, solid wedge, 125 lb. with wheel handle.
- D. Lift Check Valves (vertical): Nibco T-480-Y-LF or KITZ 836; bronze body, inline lift type, Teflon seat, and discs, spring actuated, 125 lb.
- E. Swing Check Valves (horizontal): Nibco T-413-Y-LF, Stockham B-345, or KITZ 822T; bronze body, Y-pattern swing-type, rated 200 PSI non-shock CWP. Body, bonnet, and disc hanger shall be of lead-free dezincification-resistant material and TFE seat disc. Valve ends shall be threaded type. Valves shall be 3rd party certified to Annex G of NSF/ANSI 61.
- F. Circuit Setters: IIT Bell & Gossett, Circuit Setter Plus series, Model CB, calibrated balance valves with NPT and solder connections. Valves shall be designed to allow installing contractor to pre-set balance points for proportional system balance prior to system start-up. All valves ½" to 3" pipe size to be of bronze body/brass ball construction with glass and carbon filled TFE seat rings. Valves to have differential pressure read-out ports across valve seat area. Read-out ports shall be fitted with internal EPT inserts and check valves. Valve bodies to have 1/4" NPT tapped drain/purge port. Valves shall have memory stop feature to allow valve to be closed for service and then reopened to set point without disturbing balance position. All valves

to have calibrated nameplates to assure specific valve settings. Valves shall be designed for positive shut-off.

- G. Gas Shut-off Valves:
1. At Building Service: Homestead Fig. 601, pressure Class 125 lubricated plug valve, cast iron, lever handle, 200 lb., leak and hydro tested. Install Pacific Seismic earthquake sensitive valve, 300 series, seismic actuated automatic shut off valve at meter (or entrance to building if not new construction). Brace per manufacturer's instructions.
  2. At Connection to Equipment:
    - a. Jomar T-203 gas ball valves, 2-piece design, threaded connection; 2 "Viton" o-rings; 1/8-inch side tap; leakproof stem; removable plug.
    - b. Brass Craft "Safety+PLUS" "ProCoat" gas connector with excess flow valve.
- H. Gas Pressure Regulators: Pietro Fiorentini "Governor" series, or equal, standard model; ANSI Z21.80 compliant or approved equal. Regulators shall be sized for full gas capacity of equipment as scheduled on the Drawings. Inlet and outlet pressure shall be field verified. Regulators installed indoors shall have relief opening piped to outdoors. Size relief pipe in accordance with ANSI Z223.1 "National Fuel Gas Code".
- I. Gas Service Line Risers: Elster Perfection anodeless service line risers and transition fittings or equal
- J. Water heater temperature/pressure relief valves: Watts series LF100XL or equal; lead free copper alloy body; stainless steel spring; CSA and ASME Rated; ANSI Z21.22 certified. The BTU discharge capacity of the device shall be in excess of the BTU input rating of the heater.
- K. Water Pressure Regulating Valves: Zurn Wilkins 500XLYSBR series or approved equal. Cast bronze valve body, stem and plunger; stainless steel fasteners, strainer screen and seat. Meets NSF61. Install where pressure to building exceeds 70 psi.
- L. Backflow Preventers (Where shown on the Drawings or required by local code):
1. Atmospheric type: Zurn Wilkins #35 series or equal Watts or Cash Acme
  2. Pressure type: Zurn Wilkins #720A series or equal Watts or Cash Acme
  3. Reduced Pressure type: (main cold water line):
    - a. 1/4" to 2" - Zurn Wilkins #975-XLMS series, or equal Watts or Cash Acme
    - b. 2 1/2" to 10" - Zurn Wilkins #375 series, or equal Watts or Cash Acme

## 2.04 EXPANSION LOOPS

- A. Metraflex "Gas Metraloop" or approved equal. Loops shall be standard weight, carbon steel conforming to ASTM A234/ASME B16.9. The corrugated hose shall be stainless steel, type 321. The braid shall be 304 stainless steel, and end fitting shall be carbon steel plate flanges with 150 lb. drilling. Flexible hose expansion loops for flammable liquid or gas service up to 4" shall be CSA/AGA listed and be in conformance with UL-536.
- B. Provide flexible hose expansion loop(s) as indicated on the Drawings or as required to accommodate any thermal expansion, contraction, building settlement, or seismic movement of the piping system.
- C. Flexible hose expansion loops shall be manufactured complete with two parallel sections of corrugated metal hose, compatible braid, 180 deg return bend, with inlet and outlet connections. Field fabricated loops shall not be acceptable.
- D. Flexible loops shall be capable of movement in the  $\pm X$ ,  $\pm Y$ , and  $\pm Z$  planes.
- E. Flexible hose expansion loops shall impart no thrust loads to system support, anchors or building structure.

- F. All flexible hose expansion loops shall be manufactured in accordance with the documented manufacturers weld procedure specifications. The procedure qualification record shall be used to document the execution of this procedure and shall follow the general "guidelines" of ASME Section IX. Each individual welder shall conform to the in-house procedure qualification record and be qualified prior to each production lot. The testing of each individual welder shall be documented in a welding procedure qualification record.

## 2.05 UNIONS

- A. Unions or flanges shall be furnished and installed at each threaded connection to all equipment or valves. The unions shall be located so that the piping can be easily disconnected for removal of the equipment, tank, or valve, and shall be of the type specified in the following:
  - 1. Steel pipe: Class 150, malleable iron, ground joint: Anvil Figure 463, Stockham, or equal. ASME B16.39.
  - 2. Copper pipe: cast copper alloy, soldered joint: Nibco series 633 or 733, Mueller Streamline, or equal. MSS SP-123
  - 3. Dielectric: lead free: Watts, Jomar, or equal. ASSE 1079

## 2.06 HOSE BIBBS

- A. HB-1: Hose Station
  - 1. Strahman or equal, model CEC-1000 series, enclosed cabinet recessed wall-type stainless steel cabinet; Strahman M-159TG series mixing unit/hose station that includes dial-type gauge to indicate wash temperature and blending chamber for hot and cold water; and Strahman hose assembly A with Low Flow M-70 series spray nozzle. Nozzle shall have replaceable heavy duty renewable rubber cover, stainless steel seat and instant water shut off.
- B. HB-2: (Exterior Hose Bibb) Narrow Wall Hydrants: Zurn Z 1350EZ, or equal Jay R Smith, encased moderate climate for narrow wall installation. Bronze body & interior parts; replaceable seat washer, screwdriver operated stop valve in supply; key operated control valve, ¾ IP female inlet and ¾ male hose connection; stainless steel box and hinged cover with cylinder lock and "WATER" stamped on cover.
  - 1. Note: After the hydrant box has been properly set, additional caulking of all inside joints is required, including the seams where gasket is present.

## 2.07 FLOOR DRAINS

- A. Floor Drains: Drains in membrane dampproofed floors shall have flashing flange and membrane clamp. Drains in sheet vinyl floors shall have a 14" square latex flange.
  - 1. FD-1: Zurn ZN415S-P. Dura-Coated cast iron body with bottom outlet, combination invertible membrane clamp and adjustable collar with seepage holes and type "S" polished, nickel bronze strainer and trap primer connection. 2" pipe size, 5" x 5" square top grate. Drains in sheet vinyl floors shall have a 14" square latex flange (ZN-415-SL-P).

## 2.08 FLOOR SINKS

- A. Floor Sinks: Where shown on the Drawings, floor sinks shall be as follows:
  - 1. FS-1: Zurn Z1901-P-2, or equal Jay R Smith, Sani-Flor receptor with ½ grate. 12" x 12" x 8" deep, cast-iron body and square light duty ½ grate with ½" slotted openings, white acid resisting porcelain enamel interior and top, complete with ABS anti-splash interior bottom dome strainer and ½ trap primer connection, 2" pipe size. Set rim flush with finished floor.

**2.09 ROOF DRAINS**

- A. RD (Combination Roof/Overflow Drain): Zurn Z-164 (12") or Jay R. Smith Figure 1850 or equal, 12" diameter roof and overflow drain combination. Dura-Coated cast iron bodies with combination membrane flashing clamp/gravel guards, double top set deck plate, and low silhouette cast iron dome. Provide with downspout nozzle, nickel bronze. Zurn ZANB-199 or Jay R.Smith Figure 1770.

**2.10 PIPE INSULATION**

- A. Insulate all hot water supply piping, all hot water return piping, all tempered water supply piping and all tempered water return piping with Johns Manville "Micro-Lok HP", or equal, rigid fiberglass one-piece pipe insulation or Knauf Insulation "Earthwool 1000°" or "Earthwool Redi-Klad 1000° rigid glass mineral wool one-piece pipe insulation, or approved equal.
- B. Pipe covering shall have factory applied All Service Jackets (ASJ). Jackets shall be constructed of high density, white kraft bonded to aluminum foil with fiber glass yarn, with a pressure sensitive closure system, or of aluminum foil reinforced with a glass scrim bonded to a kraft paper interleaving with an outer film layer leaving no exposed paper. Adhesives or staples shall not be required to seal the jacket and butt strips.
- C. All insulation shall have composite (insulation, jacket, tape seal, and adhesive used to adhere the jacket to the insulation) Fire and Smoke Hazard ratings as tested under Procedure ASTM E 84 and NFPA 255, not exceeding: Flame Spread - 25, Smoke Developed - 50. PVC fitting covers, jacketing and accessories such as adhesives, mastics, cements and cloth for fittings should have the same component ratings.
- D. Insulation thickness shall conform to Title 24, Part 6 requirements as indicated in the following table:

FLUID TEMPERATURE RANGE (°F)	CONDUCTIVITY RANGE (in Btu-inch per hour per square foot per °F)	INSULATION MEAN RATING TEMPERATURE (°F)	NOMINAL PIPE DIAMETER (in inches)				
			1 and less	1 to <1.5	1.5 to < 4	4 to < 8	8 and lgr
			INSULATION THICKNESS REQUIRED (in inches)				
Space heating, Hot Water systems (steam, steam condensate and hot water) and Service Water Heating Systems							
201-250	0.27-0.30	150	2.5	2.5	2.5	3.0	3.0
141-200	0.25-0.29	125	1.5	1.5	2.0	2.0	2.0
105-140	0.22-0.28	100	1.0	1.5	1.5	1.5	1.5

- E. Fittings, valves and flanges shall be covered with Manville "Zeston 2000" insulated PVC fitting covers and Hi-Lo Temp insulation inserts or Knauf "Proto LoSmoke". Insulation for all exposed piping and all piping in crawl spaces shall be covered with Zeston PVC jacketing. PVC jackets shall be 20 mils thick and shall be bonded with Zeston Perma-Weld adhesive. In crawl spaces, Knauf Earthwool RediKlad 1000° pipe covering shall serve as an acceptable alternate to standard pipe covering and PVC.
- F. All piping exposed to the weather shall be finished with aluminum jacketing with a laminated moisture retarder or Earthwool RediKlad 1000° with Venture Clad embossed jacket. Aluminum jacketing shall be overlapped 2 to 3 inches and held in place with stainless steel bands to form a



weather tight system. Elbows and tees shall be fitted with matching aluminum fitting covers. Other fittings in metal-jacketed systems shall be finished with conventional weather-resistant insulating materials with painted aluminum finish.

- G. All domestic water piping below grade shall be insulated with Dow Trymer-2000. Pipes shall be sleeved with 30 mil PVC jacket, with glued joints.

## 2.11 DIELECTRIC FITTINGS

- A. Precision Plumbing Products, "Clear Flow" series, threaded dielectric fittings, sizes 19100P thru 19195P.
- B. Dielectric fittings shall have zinc electroplated steel casing, and NSF/FDA listed lining. Fittings shall meet the requirements of ASTM standard F1545 for continuous use at temperatures up to 225°F (- +5°F), for pressures up to 300 psi, and shall achieve a dielectric waterway in all potable water applications.

## 2.12 CLEANOUTS

- A. Cleanouts in membrane dampproofed floors shall have flashing flange and membrane clamps. Plugs shall be bronze, with cast iron body ferrule for cast iron pipe.
- B. Floor Cleanouts (FCO): Zurn ZN1400-HD, "Level-trol" adjustable floor cleanouts, dura-coated cast iron with gas and water-tight ABS tapered thread plug, and round scoriated top, adjustable to finished floor.
- C. Grade (COTG): Zurn Z1474-N or equal Jay R Smith. Housing to be dura-coated cast iron body with integral anchor flange and scoriated cover with lifting device. Cleanouts in un-paved areas shall be set in 18" x 18" x 4" concrete pads.
- D. Accessible:
  - 1. Cast iron pipe: Zurn Z-1440, dura-coated with gas and water-tight, bronze, taper thread plug
  - 2. Steel pipe: Zurn Z-1470-A bronze, raised head, cleanout plug.
  - 3. Copper tubing: Nibco figure 816 or 817.
- E. Wall Cleanouts (WCO):
  - 1. Copper tubing: Nibco figure 816 or 817, with Zurn Z-1462, 6" x 6" polished chrome-plated bronze wall plate and frame.
  - 2. Cast iron pipe: Zurn Z-1441, dura-coated with gas and water-tight bronze, taper thread plug and round smooth stainless steel access cover with securing screw
  - 3. Steel pipe: Zurn Z-1468, round stainless steel wall access cover, complete with securing screw and bronze raised hex head plug for steel pipe.

## 2.13 SLEEVES, WALL PLATES

- A. Service pipe through exterior walls, roofs; interior walls, ceilings: Sioux Chief or equal, wall and ceiling plates; chrome plated at finished rooms.
- B. Pipes through, under footings: 18 gauge iron sleeves two diameters larger than pipe, cast in concrete, annular space filled with mastic or plastic bituminous cement.
- C. Pipes through fire rated walls and through 1-hour walls shall be protected with fire retardant mastic as detailed on the drawings. Installation shall be in full accordance with the requirements of the UL system number. Hilti or approved equal.

- D. Pipes through floors, interior concrete walls, and through fire rated walls and smoke stop partitions: 18 gauge iron sleeves, two diameters larger than pipe, annular space filled with 3M Brand Fire Barrier CP-25 caulk.

#### 2.14 STRAINERS

- A. Metraflex model LPD-Mag, or equal, "Y" pattern pipeline strainer where shown on Drawings or required by equipment manufacturer. Y strainer shall be of the low pressure drop design. Strainer body shall be ASTM A126-B cast iron, flanges shall be ASME B16.5, and screens shall be Type 304 stainless steel. Strainer shall have a screen pitch of 22.5°. Screens shall be removable via an access cover sealed with an O-ring gasket. Screen pitch shall be 20-25°F
- B. Magnets shall be minimum 8000 Gauss magnet(s). 6" and smaller shall have one magnet, 8" and larger shall have two. Magnets shall be neodymium. Type 304 stainless magnet tube shall be installed in a Type 304 stainless steel drywell.
- C. Strainer shall be manufactured with .25" pressure differential ports, with one placed on each side of screen. Strainer shall be equipped with a dry well port. Port shall be .5" for sizes 2" - 3" and 1" for sizes 4" and up. Strainer connection shall be 125 lb. class flange.

#### 2.15 SHOCK ABSORBERS

- A. Zurn Z1700 "Shoktrol" series, or equal Jay R Smith, stainless steel bellows. Install with gate valve shut-off and access door at all flush valves or other automatic valves. A single unit sized in accordance with the manufacturer's recommendations may serve batteries of valves.

#### 2.16 TRAP PRIMERS

- A. Trap primers shall be installed for all floor drains as follows:
  - 1. Trap primers shall be Precision Plumbing Products model PR-500 (automatic) or P2-500 (adjustable). Trap Primers shall be pressure drop activated and be of all brass construction including a brass body with ½" male NPS inlet and ½" female NPT discharge. Internal components shall consist of a #60 stainless steel debris screen, brass piston and brass discharge jet. Lubricated O-rings shall be EPDM E70. Adjustable model shall have stainless steel adjustment screw.
  - 2. Trap primers shall be installed on fresh cold-water lines of 1 ½" diameter or less and shall be located where they will be subjected to frequent pressure drops of at least 10 psi. Install with shut off valve and access doors in Janitor's closets, Mechanical Rooms and other areas not served by, or in close proximity to, flushometer valve operated water closets.
  - 3. Working pressure shall be 20 to 80 psig.
- B. Electronic trap primers
  - 1. 1. Sioux Chief 695-ER series electronic trap primer or approved equal. Unit shall be mounted in a steel recessed access box and shall be equipped with solenoid actuating device, vacuum breaker, distribution manifold, and electrical hardware. Trap primer shall be equipped with an ASSE 1010 arrester to protect the solenoid. Frequency and duration of activation shall be adjustable.

#### 2.17 ACCESS DOORS

- A. Where construction is not inherently accessible, provide adequately sized and conveniently located access doors in ceilings, walls, and furring for access to controls and for servicing valves, equipment, etc.

- B. Access doors shall be flush, prime coated steel except for tiled surfaces, and screwdriver operated latch/locks, except for fire-rated. Minimum size shall be 12" x 12". Provide larger sizes where required.
  - 1. Fire Rated walls and ceilings: Milcor style UFR, Karp style KRP, or approved equal, U.L. Class B, 1½ hour rated, 20-gauge steel door; 16-gauge steel frame; insulated, self-closing, continuous piano hinge; keyed paddle latch, interior latch release.
  - 2. Drywall ceilings or walls: Milcor style DW, Karp style KDW or approved equal, drywall bead; 16-gauge steel frame & door or 16-gauge steel frame & 14-gauge steel door; concealed spring hinge
  - 3. Masonry walls: Milcor style M, Karp style DSC-214M, or approved equal, 16-gauge steel frame & door or 16-gauge steel frame & 14-gauge steel door; spring loaded hinge
  - 4. Tiled walls and ceilings: Milcor style MS, Karp style DSC-214M(S), or approved equal, 16-gauge stainless steel frame & door or 16-gauge stainless steel frame & 14-gauge stainless steel door; satin finish; spring loaded hinge
  - 5. Plastered walls and ceilings: Milcor style K, Karp style DSC-214PL, or approved equal, 16-gauge steel frame; 14-gauge steel door; casing bead; concealed spring hinge or continuous piano hinge
- C. Doors shall be delivered to the General Contractor for installation.

## 2.18 PRESSURE GAUGES

- A. Pressure gauges shall be Marsh "Mastergauges", Weksler, or approved equal, chrome cast, bronze bushed movement, with white dials and black numerals, 3½" dial with recalibrator.

## 2.19 THERMOMETERS

- A. Weksler "Adjust-Angle", or equivalent Weiss, with separable sockets and 6" minimum scale reading 30-240°F.

## 2.20 VALVE BOXES

- A. Oldcastle #B09, "Christy" concrete, light duty utility box, with concrete cover and required extensions, straight wall. Index all covers "GAS" or "WATER" as required for service use.

## 2.21 VIBRATION AND SOUND CONTROL

- A. Make all necessary provisions to prevent the transmission of vibration to the building structure and the passage of noise from the equipment rooms to other rooms. Provisions shall include: vibration isolators for motor driven equipment; flexible pipe connections to motor driven equipment; resilient mounting for piping; sealing off pipe and duct penetrations of walls, floors and ceilings of equipment rooms.
- B. Provide pipe and sound isolation for all piping through walls, Acoustoplumb by LSP Products, Holdrite Silencer by Hubbard Enterprises, or equal.

## 2.22 FIXTURES

- A. The quantity and location of fixtures shall be taken from the Architectural and Plumbing drawings. Provide adequate supports and all standard trim normally furnished for fixtures. All enamel shall be acid resisting. Traps, unless otherwise noted shall be 17 gage brass tubing, chrome plated when exposed.
- B. Submit catalog cut-sheets on all fixtures.

- C. Except as otherwise shown, provide ¼" steel backing plates, 36" wide by 12" high minimum size, secured to a minimum of three studs by welding, or with ¼" x 2½" lag screws for all wall hung fixtures for which no other means of support is specified.
- D. Stops and supplies: Provide stops for all fixtures. Unless otherwise specified, stops exposed at lavatories and similar fixtures shall be Chicago #1016ABCP chrome plated, loose key. Concealed stops shall be Chicago #1771ABCP.
- E. All vitreous china fixtures shall be American Standard, except where specifically noted otherwise. All fixtures shall be standard white color, except as noted.
- F. Accessibility
  - 1. Plumbing fixtures and accessories provided in a toilet room or bathing room required to comply with CBC Section 11B-213.2 shall comply with CBC Section 11B-213.3.
  - 2. Accessible plumbing fixtures shall comply with all the requirements in CBC Division 6.
  - 3. Clearance around accessible water closets and in toilet compartments shall be 60 inches minimum measured perpendicular from the side wall and 56 inches minimum measured perpendicular from the rear wall per CBC Section 11B-604.3.1.
  - 4. Heights and location of all accessible fixtures shall be mounted according to CBC Sections 11B-602 through 11B-612.
  - 5. Accessible fixture controls shall comply with CBC Sections 11B-602.3 for drinking fountains, 11B-604.6 for water closets, 11B-604.9.5 for children's water closets, 11B-605.4 for urinals; 11B-606.4 for lavatories and sinks, 11B-607.5 for bathtubs, 11B-608.5 for showers, and 11B-611.3 for washing machines and clothes dryers.
  - 6. Accessible lavatories and sinks shall be mounted with the front of the higher of the rim or counter surface 34" maximum above the finish floor or ground. Depth of lavatories or sinks shall not interfere with knee and toe clearance provided in accordance with CBC Section 11B-306 when a forward approach is required. CBC Sections 11B-606.3 and 11B-606.7.
  - 7. Water supply and drain pipes under accessible lavatories and sinks shall be insulated or otherwise configured to protect against contact. There shall be no sharp or abrasive surfaces under accessible lavatories and sinks. CBC Section 11B-606.5.
  - 8. Effective March 1, 2017, all single-user toilet facilities shall be identified as Gender Neutral facilities by a door symbol that complies with CBC Sections 11B-216.8 and 11B-703.2.6. No pictogram, text or braille is required on the symbol. If tactile jamb signage is provided, the signage shall comply with the appropriate technical requirements of CBC Section 11B-703. Examples of appropriate designations are "ALL GENDER RESTROOM", "RESTROOM" or "UNISEX RESTROOM". This image represents the required door symbol. 
- 9. P-1 WATER CLOSET
  - a. Fixture: American Standard #3351.101 "Afwall Millennium FloWise" series; wall mounted; elongated bowl; top spud; 1.28 gpf. See Architectural Drawings for mounting height.
  - b. Flush Valve: Sloan "Royal" 111-1.28 or approved equal; ADA compliant; exposed; 1.28 gpf.
  - c. Seat: Olsonite #95SSCT or equal; extra heavy duty; elongated; open front; modified open back; contoured extra wide shape; integral bumpers; ; STA-TITE fastening system; check hinge; white.
  - d. Carrier: Zurn Z-1201 or 1202 or equal, no-hub; 500 lb. capacity with auxiliary inlets as required.
- 10. P-1B WATER CLOSET (ADA)

- a. Fixture: American Standard #3043.001 "Madera FloWise" 16 1/2" height, ADA compliant; elongated bowl; floor mounted; top spud; 1.28 gpf.
  - b. Flush Valve: Sloan "Royal" 111-1.28 or approved equal; ADA compliant; exposed; 1.28 gpf. Install the flush valve lever on the wide side of the ADA water closet enclosures.
  - c. Seat: Olsonite #95SSCT or equal; extra heavy duty; elongated; open front; modified open back; contoured extra wide shape; integral bumpers; ; STA-TITE fastening system; check hinge; white.
  - d. Carrier: Zurn Z-1201 or 1202 or equal, no-hub; 500 lb. capacity with auxiliary inlets as required.
11. P-2 - LAVATORY
- a. Fixture: American Standard #0355.012 "Lucerne"; vitreous china; 20-1/2" x 18-1/4"; 4" centers; See Architectural Drawings for mounting height.
  - b. Faucet: Chicago Faucets #802-VE2805-665ABCP or equal; metering; 4" integral cast brass spout; vandal proof .5 gpm pressure compensating spray outlet; 1 3/4" metering handles with hot and cold index buttons; vandal resistant. (HW/CW)
  - c. Drain: McGuire #155A or equal; open grid P.O. plug
  - d. P-Trap: McGuire #8902 or equal.
  - e. Carrier: Zurn #Z-1251 with concealed arms or equal Jay R Smith
12. P-2A - LAVATORY(ADA)
- a. Fixture: American Standard #0355.012 "Lucerne" series; vitreous china; 20-1/2" x 18-1/4"; 4" centers; See Architectural Drawings for ADA mounting height.
  - b. Faucet: Chicago Faucets #802-VE2805-665ABCP or equal; metering; 4" integral cast brass spout; vandal proof .5 gpm pressure compensating spray outlet; 1 3/4" metering handles with hot and cold index buttons; vandal resistant. (HW/CW)
  - c. P-Trap: McGuire PW2150WC prewrapped cast brass p-trap w/cleanout and offset grid drain and seamless riser tube covers, supply angle stop covers, angle stop wheel handle covers and chrome plated box flange to comply w/ADA.
  - d. Carrier: Zurn Z-1251 or equal
13. P-4 - MOP SINK
- a. Fixture: Florestone Model #96; neo angle; drop front mop receptor; 24" x 24" x 12"; terrazzo; steel flange & stainless-steel cap.
  - b. Faucet: Chicago 897-RCF; vacuum breaker; pail hook; rough chrome plated; adjustable centers.

## 2.23 KITCHEN FIXTURES

- A. The quantity and location of fixtures shall be taken from the Architectural and Plumbing Drawings.
- B. All kitchen equipment shall be furnished by kitchen equipment contractor. This Contractor shall take delivery of the fixtures at the job site and shall install all fixtures. Installation shall include setting and leveling all fixtures.
- C. This Contractor shall rough-in all plumbing required for the installation of the kitchen equipment; install all faucets and fixtures from which water is dispensed; make final plumbing

connections to all kitchen fixtures scheduled for plumbing connections; install indirect wastes from fixtures to the nearest floor sink on all fixtures requiring indirect waste; install direct waste and vent connections, including P-traps, on all fixtures requiring direct waste and vent. Traps unless otherwise noted shall be 17-ga. brass tubing, chrome plated when exposed. All exposed indirect wastes shall be chrome plated copper.

- D. Stops and supplies: Provide stops for all fixtures. Unless otherwise specified, exposed stops shall be Chicago #1016ABCP chrome plated, loose key. Concealed stops shall be Chicago #1771ABCP.
- E. Submit cuts on all stops, traps, etc., furnished by this Contractor.
- F. Install the main gas shut off valve for the range hood fire extinguishing system and make final gas connections to ranges and ovens. The main gas shut off valve shall be furnished with the range hood fire extinguishing system.

#### **2.24 GAS-FIRED WATER HEATERS**

- A. Natural gas water heater shall be A.O. Smith "Cyclone Xi", model BTX, as scheduled on the Drawings, or approved equal, with 96% thermal efficiency; an input rating of 100,000 BTUs per hour, a recovery rating of 116 gallons per hour at 100°F rise and a maximum hydrostatic working pressure of 150 psi.
- B. Water heater(s) shall be of power direct vent design, using 2" or 3" PVC, CPVC, or polypropylene pipe for horizontal and/or vertical vent runs. Water heater(s) shall have:
  - 1. Steel tank construction with seamless glass lining and a spiral-shaped heat exchanger placed entirely inside the tank, which shall be glass-lined on the flue gas side to protect against acidic condensate.
  - 2. Advanced electronic control with LCD touchscreen display and integral diagnostics.
  - 3. A 3-year limited warranty against tank leaks.
  - 4. Water heater(s) shall meet the thermal efficiency and standby loss requirements of the U.S. Department of Energy and current edition of ASHRAE/IES 90.1 and be design-certified by CSA International according to ANSI Z21.10.3-CSA 4.3 standards governing storage tank water heaters.

#### **2.25 ELECTRIC WATER HEATERS**

- A. A.O. Smith "Dura-Power" series, model DEL-40 as scheduled on the Drawings or approved equal. Heater(s) shall be listed by Underwriters' Laboratories. Models shall meet the standby loss requirements of the U.S. Department of energy and current edition of ASHRAE/IES 90.1.
- B. Heater(s) shall have 150 psi working pressure and be equipped with extruded high-density anode rod. All internal surfaces of the heater(s) exposed to water shall be glass-lined with an alkaline borosilicate composition that has been fused-to-steel by firing at a temperature range of 1400°F to 1600°F. Electric heating elements shall be medium watt density with zinc plated copper sheath. Each element shall be controlled by an individually mounted thermostat and high temperature cutoff switch. The outer jacket shall be of backed enamel finish and shall enclose the tank with foam insulation. Electrical junction box with heavy duty terminal block shall be provided. The drain valve shall be located in the front for ease of servicing.

#### **2.26 TANKLESS WATER HEATERS**

- A. Chronomite ER series, "Triplets" model ER-90L/208\_3P, "Instant-Temp", high capacity, 3-phase, low activation, L3 model, as scheduled on the Drawings or approved equal.

- B. The housing shall be fabricated from "Jet Kote" gray steel. The element assembly/waterways shall be fabricated from Celcon/Delrin plastic and the heating coils shall be nichrome.
- C. The water heater shall use a digital microprocessor for temperature control, with response times for temperature variations @ 120 times per second. User adjustable temperature from 70°F-125°F, standard. Flow rates from 0.35 gpm to 4.5 gpm.

## 2.27 EXPANSION TANK

- A. Amtrol "Therm-X-trol", model ST-12. Tank shall be constructed of steel and a urethane topcoat. The tanks shall have an antimicrobial polypropylene liner, a heavy-duty Butyl NSF/ANSI 61 diaphragm, a projection welded air valve with "InSight™" indicator cap that changes color to indicate tank service, and a patented "Turbulator™" water circulator. The tank shall have a factory pre-charge of 50 PSIG.

## 2.28 HOT WATER CIRCULATION PUMPS

- A. Bell & Gossett NBF-12 in-line circulating pump as indicated on the Drawings or approved equal.
- B. The pumps shall be of the horizontal system lubricated type. Pumps shall be suitable for 230°F operation at 150 psig working pressure.
- C. The pumps shall have a ceramic shaft supported by carbon bearings. Bearings are to be lubricated by the circulating fluid.
- D. Pump body shall be lead-free bronze.
- E. Motor stator to be isolated from circulating fluid through use of stainless steel can. Rotor to be sheathed in stainless steel. Motors shall be non-overloading at any point on the pump curve and shall built-in impedance protection.

## 2.29 AQUASTAT

- A. Bell & Gossett Aquastat, model AQS-1/2 or AQS-3/4. The aquastat shall be UL approved. The thermostat covering shall be epoxy, environmentally sealed, and the thermostatic sensing element, which senses surface temperature of outside diameter of pipe, shall be bimetal.

## 2.30 GREASE INTERCEPTOR

- A. Zurn / Green Turtle "Proceptor" series model GMC 1000 FL as scheduled on the Drawings or approved equal. Elliptical fiberglass (FRP) construction, factory installed Schedule 40 PVC cement welded type socket ports, or straight pipe, fitted into interceptor walls for each pipe connection.
- B. Accessway Frames and Covers: Round cover with non-slip cover finish, gasketed and non-vented top design with "Proceptor" lettering cast into cover
  1. Cast Iron: AASHTO M306 Traffic load rated. 24" diameter cover with 0.25" gasket. Two closed pickholes. Weight 249 lbs. ASTM A48 CL35B.
  2. Fiberglass: Pedestrian loading 24" diameter bolted and gasketed.
- C. Watertight flexible caulking: Sikaflex 255 or Sikaflex 221 or approved alternate.

## 2.31 HANGERS AND SUPPORTS

- A. All piping shall be supported with Superstrut, B-Line, Anvil, Mifab, or approved equal pipe hangers and supports. Select size of hangers and supports to exactly fit pipe size for bare piping, and to exactly fit around piping insulation with shield for insulated piping.

- B. Hangers and supports shall be designed and manufactured in conformance with ANSI/MSS SP-58. Selection and application shall be in accordance with ANSI/MSS SP-69.
- C. All hangers shall be electro-chromate or corrosion resistant finished. Hanger rods shall have electro-galvanized finish.
- D. Roof top pipe supports
  - 1. MiFab "C-Port" series or B-Line "Dura-Block" or approved equal.
    - a. Model C rubber support series with 14-gauge galvanized channel.
    - b. Seismic: Model CZ rubber base with 14-gauge galvanized channel
- E. Seismic hanger rod stiffeners: B-Line SC-228, Anvil AS 3500 or approved equal
- F. Copper tubing:
  - 1. B-Line 3690, Superstrut C-711 or Anvil Figure 67 "J" pipe hangers or approved equal, complete with isolator.
  - 2. Isolators: B-Line "Vibra Cushion" B1999, Type L & K for copper tubing, Superstrut C-716 isolator for copper, Anvil Figure CT-769 or approved equal
- G. Insulated pipe:
  - 1. Hangers: B-Line 3690 "J" pipe hanger, Superstrut C -711 or Anvil Figure 67 fitted to outside of insulation or approved equal
  - 2. Pipe Shields: B-Line 3151 insulation protection shield, Superstrut C-790, or Anvil Figure 167 or approved equal
- H. Channel: B-Line B22, Superstrut A 1200, Anvil AS 200 or approved equal.
- I. Trapeze hangers: Grouped pipes may be supported by channel bolted to rods.
- J. Point of support connectors:
  - 1. Wood construction:
    - a. Stationary pipes: B-Line B3060, Superstrut 540 or Anvil Figure 206 side beam hanger clip or approved equal
    - b. Pipes subject to movement: B-Line B-756 or Superstrut S-541 beam clamp swing connector or approved equal
  - 2. New concrete construction: B-Line B2501 light duty spot inserts or Superstrut 452-TB spot inserts or approved equal.
  - 3. Existing concrete construction: Phillips "Red-Head" 3-piece concrete anchors or Hilti "Quik-Bolt", drilled-in, concrete anchors.
  - 4. Steel beams: Superstrut Series 500 beam brackets or equal.
  - 5. Plywood decks: machine bolts, nuts and washers.
- K. Vertical pipe risers:
  - 1. Riser clamps: Superstrut C-720 extension riser clamps anchored to construction
    - a. Bare cold water pipe: Superstrut C-720P, PVC coated to prevent corrosion.
- L. Water Heater platform:
  - 1. Wall mounted water heaters up to 20 gallons shall be supported by HoldRite "Quick Stand", #40-SWHP-W, equipment platform or equal. Constructed of galvanized steel with watertight corners and drain fittings. Includes PVC drain body.

## 2.32 VIBRATION AND SOUND CONTROL

- A. Make all necessary provisions to prevent the transmission of vibration to the building structure and the passage of noise from the equipment rooms to other rooms. Provisions shall include: vibration isolators for motor driven equipment; flexible pipe connections to motor driven



equipment; resilient mounting for piping; sealing off pipe and duct penetrations of walls, floors and ceilings of equipment rooms.

- B. All piping which is not isolated from contact with the building by its insulation shall be installed with a manufactured type isolator. Isolators shall be B-Line "Vibra Clamp" and "Vibra Cushion", Super Strut, "Trisolator", or equal. Piping shall be installed and supported in a manner to provide for expansion without strains. Guides shall be properly installed to ensure this requirement.
- C. Provide pipe and sound isolation for all piping through walls, Acoustoplumb by LSP/Specialty Products, Holdrite Silencer by Hubbard Enterprises, or equal.

### 2.33 PIPE LABELS

- A. Pipe labeling shall be in compliance with ANSI/ASME A13.1 2015 "Scheme for the identification of Piping Systems" and ANSI Z535.1 2017 "Safety Color Code". Graphic Products, Brady, Brimar, or Seton. All piping shall be identified.
- B. Submittals:
  - 1. Provide valve schedules for each piping system to include in maintenance manual.
  - 2. Provide equipment label schedule to include in maintenance manuals.
- C. Pipe Labels: Preprinted, color-coded, with lettering giving name of the contents (full or abbreviated) and arrows to indicate direction of flow.
  - 1. Self-Adhesive Pipe Labels: Printed plastic with contact-type, permanent-adhesive backing.
  - 2. Flow-Direction Arrows: Integral with piping system service lettering to accommodate both directions, or as separate unit on each pipe label to indicate flow direction(s).
  - 3. Pre-tensioned Labels: Semi-rigid plastic wrap around pipe marker that extends 360° around the pipe at each marker location. The label shall have a 1/2" strip of adhesive on the inside to further secure the marker.
- D. Pipe Label Sizes (per ANSI A13.1 / ASME A13.1-2015 Standards):
  - 1. For pipes or covering with outside diameter 3/4 to 1 1/4 inches, minimum length of label: 8 inches, minimum height of letters: 1/2 inch.
  - 2. For pipes or covering with outside diameter 1 1/2 to 2 3/8 inches, minimum length of label: 8 inches, minimum height of letters: 3/4 inch.
  - 3. For pipes or covering with outside diameter 2 1/2 to 7 7/8 inches, minimum length of label: 12 inches, minimum height of letters: 1 1/4 inch.
- E. Pipe Label Color Schedule: (per ANSI A13.1 / ASME A13.1)
  - 1. Potable, Cooling, Boiler Feed and other Water Piping:
    - a. Background Color: Green.
    - b. Letter Color: White.
  - 2. Fire Quenching Fluids:
    - a. Background Color: Red.
    - b. Letter Color: White.
  - 3. Toxic and Corrosive Fluids
    - a. Background Color: Orange.
    - b. Letter Color: Black
  - 4. Flammable and Oxidizing Fluids:
    - a. Background Color: Yellow.
    - b. Letter Color: Black.
  - 5. Combustible Fluids:
    - a. Background Color: Brown.
    - b. Letter Color: White

- F. Valve Tags:
1. For identification and Owner's maintenance records, all valves shall be numbered and identified with brass tags stamped with service abbreviation and sequential number, and pre-drilled holes for attachment hardware, in accordance with Drawings and service performed. Control valves shall be also marked whether normally open (N.O.) or normally closed (N.S.).
  2. Minimum size letters: ¼-inch; numbers ½-inch. Minimum tag size: 1 ½-inch diameter.
  3. Fasteners: Attach to stem or body of valve so that tag is visible but doesn't interfere with the valve operation. Use Brass wire-link chain or beaded chain.
  4. Valve Schedule: For each piping system, on 8 ½" x 11" bond paper, tabulate valve number, piping system, system abbreviation (as shown on valve tag), location of valve (room or space), and normal-operating position (open, closed, or modulating). The schedule shall be, shall be framed and posted in mechanical rooms and a copy provided in the maintenance manual.
- G. Equipment
1. All equipment shall be labeled with 1" high stencils showing identifying mark noted on drawings, and usage.
- H. A printed schedule of all stencils and valve tags used with identification shall be framed and posted in mechanical rooms, at locations as directed by Owner. Include a copy of the schedule in Operations and Maintenance data.
- I. Underground Pipe Warning: Provide underground pipe marking tape on all pipes buried beneath the ground. Provide a continuous length of tape 12" below the finished earth surface directly above the buried pipe. Provide a second continuous length of tape 12" above the top of the buried pipe if the top of the pipe is lower than 36" from the top of the finished earth surface. Provide 6-inch wide detectable underground tape above all buried pipes on this project. Identify water lines, pipe lines, gas lines, steam lines, and sewer lines. The tape shall be resistant to alkaline, acids, and other destructive agents usually found in soil.
- J. Warning Signs: Comply with the requirements of CCR Title 8, Section 3320 (Provide warning signs on machines that are driven by fully automatic starters that may cause injury). Sign shall include caution and warning information plus emergency notification instructions.

## **PART 3 EXECUTION**

### **3.01 GENERAL**

- A. Apply and install all items in accordance with the manufacturer's written instructions. Refer conflicts between the manufacturer's instructions and the contract drawings and specifications to the Architect for resolution.
- B. Contractor shall have examined the site, compared it with the Contract Documents, and be satisfied with the conditions under which the work is to be performed. In the event of discrepancy, the Contractor shall notify the Architect and shall proceed as directed.
- C. The Contractor shall be held responsible for all existing conditions, whether or not accurately described. No allowance shall subsequently be made on the Contractor's behalf for any error, omission, or extra expense that is due to failure or neglect on the Contractor's part to make such examination and notification.
- D. Prior to commencing the work of this Section, Contractor shall inspect the installed work of other trades and verify that their work is sufficiently complete to permit the start of work under this Section and that the finished work will be in complete accordance with the original design.

In the event of discrepancy, the Contractor shall immediately notify the Architect and proceed as directed.

- E. Provide all necessary cutting in connection with the work of this Section. No structural members shall be drilled, bored, or notched in a manner that will impair their structural capacity. Cutting or boring of joists or other structural members shall be done only when alternative routing is impossible and only upon written approval of the Architect or Owner. All penetrations of concrete or masonry shall be made with core drills. No cutting shall be done without the approval of the Architect.

### **3.02 DELIVERY, STORAGE, AND HANDLING**

- A. Contractor shall be responsible for delivery, storage, protection and placing of all equipment and materials.
- B. Contractor shall protect the work and materials from damage during construction. Equipment stored at the jobsite shall be protected from dust, water or other damage, and be covered if equipment is exposed to weather. Protect interiors of new equipment and piping systems against entry of foreign matter. Clean both inside and outside before painting or placing equipment in operation.
- C. Any items damaged shall be repaired or replaced, at no additional cost to the Owner.
- D. Cleanliness of Piping and Equipment Systems:
  - 1. Exercise care in storage and handling of equipment and piping material to be incorporated in the work. Remove debris arising from cutting, threading and welding of piping.
  - 2. Piping systems shall be flushed, blown or pigged as necessary to deliver clean systems.
  - 3. Contractor shall be fully responsible for all costs, damage, and delay arising from failure to provide clean systems.

### **3.03 COORDINATION**

- A. All work shall be coordinated with water, gas, sanitary sewer, and other services on the site. The locations of points of connection to the site services shall be confirmed prior to commencement of work.
- B. Coordinate roughing-in and final plumbing fixture locations, and verify that fixtures can be installed to comply with original design and referenced standards.

### **3.04 COOPERATION WITH OTHER TRADES**

- A. Cooperate fully with other trades doing work on the project as may be necessary for the proper completion of the project. Refer to the Architectural and Structural Drawings for details of the building structure and equipment installation that will tend to overlap, conflict with, or require coordination with the work of this Section, and schedule this work accordingly.
- B. Priority of right of way in space shall be as follows, in decreasing order of authority:
  - 1. Electrical lights, electrical panels and drain piping.
  - 2. Ductwork.
  - 3. Fire protection piping, domestic hot water, domestic cold water and condenser water piping.
- C. Verify clearance requirements of all electrical and mechanical equipment/systems prior to installation of any new work. Plumbing equipment, piping, systems, etc. shall not interfere with electrical equipment spaces.
- D. Any work done without regard for other trades shall be moved, replaced, or redone as required, without extra charges to Owner.

### 3.05 VERIFICATION OF EXISTING CONDITIONS AND DEMOLITION

- A. Before installation of any new work, verify the location, size and other conditions at all points of connection to services or other existing piping, and at all locations where new work will cross or pass near existing piping, electrical, or other facilities.
- B. Information shown relative to existing services is based upon available records and data during preparation of the Drawings, but shall be verified. Make reasonable deviations found necessary to conform with actual locations and conditions, without extra charge.
- C. Remove piping, controls, fixtures, and equipment that is not to remain in service as shown on the Drawings or as required. This includes the removal of associated appurtenances and supports.
- D. Patch, cap, or repair existing works affected by this demolition in concealed spaces within 6" of a live main or branch.
- E. Deliver removed material to the Owner as directed by the Architect. Dispose of all other removed material offsite.

### 3.06 ACCESSIBILITY

- A. Equipment shall be placed and piping connections made in such a manner that all routine adjustments and maintenance operations may be carried out without inconvenience and so that all code requirements for clearances are maintained.

### 3.07 VIBRATION AND SOUND CONTROL

- A. Make all necessary provisions to prevent the transmission of vibration to the building structure and the passage of noise from the equipment rooms to other rooms. Provisions shall include: vibration isolators for motor driven equipment; flexible pipe connections to motor driven equipment; resilient mounting for piping; sealing off pipe and duct penetrations of walls, floors and ceilings of equipment rooms.

### 3.08 EQUIPMENT

- A. Equipment shall operate quietly and without objectionable vibration. Such problems, other than from equipment operating at optimum conditions, shall be the Contractor's responsibility and shall be eliminated at the direction of the Architect.
- B. Install equipment to provide good appearance, easy access, and adequate space to allow replacement and maintenance. Provide bases, supports, anchor bolts, and other items required to achieve this. Installation shall be level, above moisture level, and adequately braced.
- C. Extend ¼" schedule 40 black steel lubrication pipes from hard-to-reach locations to front of equipment or to access doors. Terminate with proper lubrication fittings.
- D. Move equipment into building through available openings. Dismantle equipment where necessary to accomplish this. After reassembly, test equipment to verify its satisfactory operating condition.
- E. Thoroughly lubricate equipment before operating. Repair of damage resulting from failure to comply with this requirement shall be the Contractor's responsibility.
- F. Connections to piping shall be secured and properly aligned and all utility and control connections shall be properly isolated from the building structure by means of vibration isolators and flexible connections. Any equipment not meeting this requirement will be modified and properly reinstalled at no expense to the Owner.

### 3.09 INSULATION

- A. Insulation shall be applied in complete accordance with the manufacturer's published installation instructions. All insulation shall be applied on clean, dry surfaces and shall be continuous through wall and ceiling openings and sleeves, except where fire stop materials are required.
- B. All joints shall be firmly butted together and longitudinal jacket laps and butt strips shall be smoothly secured.
- C. Specified adhesives, mastics and coatings shall be applied at the manufacturer's recommended minimum coverage per gallon.
- D. Insulation on all cold surfaces must be applied with a continuous, unbroken vapor seal. Hangers, supports, anchors, etc. that are secured directly to cold surfaces must be adequately insulated and vapor sealed to prevent condensation. Seal all pipe terminations with vapor barrier mastic.
- E. All surface finishes are to be extended to protect all surfaces, ends and raw edges of insulation.
- F. Inserts shall be installed at outside hangers. Inserts between the pipe and pipe hangers shall consist of rigid closed cell pipe insulation of thickness equal to the adjoining insulation. Inserts shall not be less than 12" long for pipe sizes through 2½" and not less than 18" long for pipes larger than 2 ½". Refer to manufacturer's recommendations for densities, sectional length, gauge of metal shield and distance between centering.
- G. Galvanized metal shields shall be applied between hangers or supports and the pipe insulation. Shields shall be formed to fit the insulation and shall extend up to the centerline of the pipe and the length specified for hanger inserts less 4" to allow for vapor retarding butt joints on each side of shields.
- H. All pipe insulation ends shall be tapered and sealed, regardless of service

### 3.10 PAINTING

- A. Properly prepare work under this Section to be painted.
- B. Painting shall be applied under the Painting section requirements, except preservative and special painting as described herein.
- C. Priming as required herein, shall conform to the Painting section requirements and be of a material compatible with paint for finish painting.
- D. Equipment in equipment rooms and like spaces, shall be furnished with a factory applied baked prime coat or at Contractor's option, a standard factory baked enamel finish in approved colors. Machinery such as fans, or motors shall be furnished with a factory applied baked on prime coat, or at the Contractor's option, a standard paint finish (air dried or baked enamel) in approved colors. Mechanical equipment in other locations shall be furnished with a factory applied baked prime coat, unless noted otherwise.
- E. All equipment and materials shall be cleaned of grease, wax, oil, rust or dirt in preparation for finish painting. Any prime coated surfaces showing signs of rust before being finish painted shall be thoroughly cleaned and a new prime coat applied.
- F. Prime paint both sides of flashings prior to installation.
- G. Furnish can of touch-up paint with each factory finished piece of equipment.
- H. Paint all piping in mechanical rooms. Color as selected by the Architect.

- I. Black steel piping exposed to the environment shall be painted with rust-inhibiting paint. Color as selected by Architect.

### 3.11 IDENTIFICATION OF SYSTEMS

- A. Pipe Markers
  1. Identify all piping on this project, except piping located within walls or inaccessible areas.
  2. Locate pipe labels where piping is exposed or above accessible ceilings in finished spaces, machine rooms, and accessible maintenance spaces such as shafts, tunnels, and plenums and at exterior exposed locations, as follows:
    - a. Adjacent to all valves and flanges;
    - b. Near each branch connection, excluding short takeoffs for fixtures and terminal units. Where flow pattern is not obvious, mark each pipe at branch;
    - c. Before and after all wall, floor and ceiling penetrations and inaccessible enclosures;
    - d. Adjacent to changes in direction;
    - e. At access doors, manholes, and similar access points that permit view of concealed piping;
    - f. Near major equipment items and other points of origination and termination;
  3. Install pipe markers on long straight runs every 20 feet. Reduce intervals in areas of congested piping and equipment.
  4. On piping above removable acoustical ceilings. Omit intermediately spaced labels.
- B. Valve Tags
  1. Identify all valves on this project, except drain lines. Attach tags so that they are easily visible but do not obstruct the operation of the valve
  2. For identification and Owner's maintenance records, all valves shall be numbered and identified with clearly stamped 1¼" diameter brass tags, in accordance with drawings and service performed.
  3. Identify all valves on this project, except drain lines. Attach tags so that they are easily visible but do not obstruct the operation of the valve.
  4. Control valves shall be also marked whether normally open (N.O.) or normally closed (N.S.).
  5. Affix Underwriter's standard porcelain enameled identification signs to all fire protection sprinkler control valves, drain valves, and flow switches.
- C. Underground Tape:
  1. Identify all underground piping on this project with a continuous length of detectable tape.
  2. If tape cannot be continuous then it must overlap by ten feet at any end.
  3. If piping is buried more than 36" below the finished earth surface then two continuous lengths of tape must be buried as described

### 3.12 EXPANSION LOOPS INSTALLATION

- A. Install and guide per manufacturers' installation instructions and Mechanical Contractors Association of America "Guidelines for Quality Piping Installations".
- B. Flexible hose expansion loop return fitting shall be supported to allow movement.

### 3.13 SEISMIC FORCE RESISTANCE

- A. Flexibility of piping systems must be maintained by the use of flexible devices at critical points at junctions of separate building structures. Braces or anchors shall be designed to damp oscillations or check excessive movement. Flexible devices for piping of gas shall be loops or offsets. Flexible devices for other piping may be loops, Victaulic grooved, or roustabout couplings.

- B. Piping at tops and bottoms of risers are critical points where flexibility is required, as well as at changes in direction on long runs of piping 4" and larger. Tops of risers shall be restrained from motion in horizontal direction, and midpoints shall be anchored in all directions
- C. Install lateral bracing with pipe hangers and supports to prevent swaying. CSway bracing shall be installed at intervals of 30 to 40 feet on pipe runs to prevent excessive lateral motion.
- D. In design of the braces, the slenderness ratio  $l/r$ , shall not exceed 200 where "l" is the effective length of the brace and "r" is the least radius of gyration, both in inches. The following table shows maximum lengths of shapes used for sway bracing:

TYPE/SIZE	MAX. LENGTH	TYPE/SIZE	MAX. LENGTH
Angle	( $l/r=200$ )	Flat Bar	( $l/r=200$ )
$1\frac{1}{2} \times 1\frac{1}{2} \times \frac{1}{4}$ "	4'-10"	$1\frac{1}{2} \times \frac{1}{4}$ "	1'-2"
$2 \times 2 \times \frac{1}{4}$ "	6'-6"	$2 \times \frac{1}{4}$ "	1'-2"
$2\frac{1}{2} \times 2\frac{1}{2} \times \frac{1}{4}$ "	8'-2"	$2 \times \frac{3}{8}$ "	1'-9"
$3 \times 3 \times \frac{1}{4}$ "	9'-10"		
Threaded Rod		Pipe (Schedule 40)	
$\frac{3}{8}$ "	1'-7"	1"	7'-0"
$\frac{1}{2}$ "	2'-1"	$1\frac{1}{4}$ "	9'-0"
$\frac{5}{8}$ "	2'-7"	$1\frac{1}{2}$ "	10'-4"
$\frac{3}{4}$ "	3'-1"	2"	13'-1"
1"	4'-2"		

**3.14 INSTALLATION, HANGERS & SUPPORTS**

- B. Pipe supports shall be spaced according to CPC 2019, Table 313.3 and sufficiently close to support pipes properly without formation of pockets. Hangers shall be installed at ends of mains and branches.
- C. Install hangers and supports complete with necessary attachments, inserts, bolts, rods, nuts, washers, and other accessories.
- D. Provide resilient mounting for domestic water piping. Thermal insulation may serve as resilient mounting for insulated piping.
- E. Suspended water piping shall be anchored with steel struts installed at midpoint of each run.
- F. No valve or piece of equipment shall be used to support piping.
- G. Install lateral bracing with pipe hangers and supports to prevent swaying.
- H. Install hangers and supports to allow controlled thermal and seismic movement of piping systems, to permit freedom of movement between pipe anchors, and to facilitate action of expansion joints, expansion loops, expansion bends, and similar units.
- I. Install building attachments within concrete slabs or attach to structural steel. Install additional attachments at concentrated loads, including valves and flanges, 2- $\frac{1}{2}$  inches and larger and at changes in direction of piping. Install concrete inserts before concrete is placed; fasten inserts to forms and install reinforcing bars through openings at top of inserts.
- J. Installation of piping shall be such that damage cannot result through loading, expansion or contraction of piping. Anchors shall be installed to obtain uniformity of pipe movement.

- K. Hanger rod sizes shall be no smaller than 3/8-inch for pipe and tube sizes 1/2 to 4 inches and 1/2 inch for sizes 5 - 8 inches.
- L. Inserts shall be installed at outside hangers. Inserts between the pipe and pipe hangers shall consist of rigid pipe insulation of thickness equal to the adjoining insulation. Inserts shall not be less than 10" long for pipe sizes up to 2 1/2" and not less than 12" long for pipes larger than 2 1/2".
- M. Metal shields shall be applied between hangers or supports and the pipe insulation. Shields shall be formed to fit the insulation and shall extend up to the centerline of the pipe and the length specified for hanger inserts.

### 3.15 PIPE WELDING

- A. All hot and chilled water, steam and steam condensate, compressed air and vacuum piping shall be installed, examined, inspected and tested in accordance with the requirements of ASME B31.9, Building Services Piping, current edition.
- B. Weld all pipe 2.5 inches and larger. Use the following procedure. All welders must be AWS certified. AWS B2.1 SMAW 6G Pipe Welding Procedure Specifications
  - Welding process: SMAW
  - Position: 6G Fixed position
  - Weld Progression: Up
  - Backing: No
  - Current/Polarity: DCEP
  - Root Opening: 1/16 to 1/8
  - Grove Angle: 60 degrees
  - Material/Spec: A 106
  - Thickness (pipe/tube): Groove (in) .280
  - Notes: Sch. 40 Pipe
  - Filler Metal Class: E6010Rt/E7018F1
  - Other Filler Metal Class: Rt. 1/8, 3/32 Filler
- C. Welded joints shall be beveled and butt-welded. Reductions of pipe shall be made with forged steel welding fittings. Branch reductions of two or more pipe sizes smaller than the main, may be Bonney "Weld-O-Let" fittings, or equal. Job fabricated reductions and branches shall not be used. All pipe burrs shall be reamed out. Welding rods shall be as follows, or approved equal:

<u>Pipe Size</u>	<u>Arc Welding</u>	<u>Gas Welding</u>
2" and larger	Fleetweld #5	Oxweld #1 or Page Hi-Test M
1 1/2" and smaller	None	Oxweld #1 or Page Hi-Test M

### 3.16 INSTALLATION, PIPING

- A. General
  1. Rough in shall proceed as rapidly as general construction will permit. All rough-in shall be complete, at locations verified by Architect and Owner, and tested and inspected prior to installation of concrete, lath, plaster, gypsum wallboard, or other finishes.
  2. All piping shall be concealed in finished rooms, installed in furred walls and partitions. Where furred or suspended ceilings occur, piping shall be installed in the concealed space at points adjacent to beams and/or other structural members, and coordinated with ductwork and equipment. Where exposed piping occurs, it shall be installed parallel to or at right angles to building walls, unless specifically shown otherwise on the Drawings.
  3. Installation of piping shall be such that damage cannot result, through thermal expansion or contraction, to piping, building, or pipe hangers and supports. Anchors shall be installed at midpoints of all runs in main piping for the purpose of localizing pipe expansion or prevention of creepage.
  4. All pipe lines shall be installed free from traps and air pockets, true to line and grade, with suitable supports properly spaced. All piping shall be installed without undue stresses and with provision for expansion and contraction.
  5. All piping shall be new and free from foreign substances. American standard pipe threads shall be used for IPS threaded work. Joints in threaded piping shall be made up with



Teflon tape applied to the male threads only. No screwed pipe joints shall be caulked or packed with rope or other packing materials. Pipe shall be free from tool marks, threads cut accurately with not more than two (2) threads showing beyond fitting. Friction wrenches shall not be used with plated, polished, or soft metal piping. All changes in pipe size shall be made with reducing fitting. Bushings will not be permitted.

6. Protect unattended openings in piping during construction.
  7. All copper tubing shall be formed in a workmanlike manner, in accordance with the Pipe and Tube Bending Handbook of the Copper and Brass Research Association. A tube bender giving support to the periphery of the tube shall be used. The tubing shall be protected against flattening or other injury.
  8. All copper connections and joints shall be made in accordance with the Copper Tube Handbook, Copper and Brass Research Association. No swaged connections will be permitted. All valves, pumps, and similar equipment shall be connected to copper piping through union or flange adapter fittings.
  9. No water or drainage piping shall pass over electrical equipment unless adequate protection is provided to prevent damage by leaks or condensation.
  10. Install air vents at all water piping high points when direction of flow is downward.
  11. Install sediment drain faucets at all low points.
  12. Valves, cocks, etc., shall be installed to allow convenient accessibility and operation.
  13. Unions and flanges shall be installed to allow convenient replacement of all equipment and cleaning tubes.
  14. A union connection shall be installed downstream from all valves, at equipment connections and at other locations as required or directed.
  15. Shut off valves shall be provided in all main services, and where required to permit proper servicing of equipment. Valves of one type shall be of one manufacturer.
  16. All valves shall be of the same size as the pipelines in which they are installed, unless specifically sized on the Drawings. All hand controlled line valves shall be ball valves, except where throttling control or frequent operation is required, in which case globe or angle valves shall be used. Globe valves in horizontal lines shall be installed with stem in horizontal to permit line draining. All globe and angle valves shall be installed to close against pressure. Disc valves shall have discs suitable for the services for which they are to be used.
  17. All valves shall be accessible and shall not be installed with the stems below the horizontal plane. Provide access panels at walls, ceilings, or floors.
  18. Provide prime coated escutcheon plates at all points where exposed piping penetrates finished wall ceilings or floors.
- B. Waste, Drain and Vent Piping:
1. Soil, waste, and vent piping occurring within the building shall be installed to a uniform minimum grade of  $\frac{1}{4}$ " per foot unless otherwise noted. Vent piping shall be graded so that all condensation shall flow directly to a soil or waste line.
  2. Exterior soil and waste lines shall be installed to inverts or grades indicated on the drawings.
  3. Bell and Spigot pipe shall be installed with the bell up grade.
  4. Changes in direction of drainage piping shall be accomplished by the use of appropriate drainage and sanitary fittings.
  5. Drilling and tapping of drains, soil, waste, or vent pipes and the use of saddle hubs and bands are prohibited.
  6. Protection against breakage of piping passing under or through walls shall be provided using specified sleeves and caulking.
  7. Adapters shall be installed between threaded iron and soil pipe.
  8. Test tees shall be installed at the foot of all soil, waste, and storm water stacks.

9. Cleanouts shall be located where indicated on the Drawings; at all horizontal offsets; at ends of waste or sewer branches more than 5' in length; at intervals of 100' in straight runs of piping, or at closer intervals if directed or required by local code. Location of cleanouts in finished spaces shall be approved by the Architect prior to installation.
- C. Hot, Cold Water Systems:
1. Di-electric unions shall be installed where copper pipe is connected to galvanized steel piping or stub outs.
  2. Connections from copper pipe to fixture supply fittings shall be made with copper or brass nipples.
  3. Provide 18" high vertical air chambers at all domestic water connections to fixtures and/or equipment that are not specified to have shock absorbers.
  4. All domestic water piping shall be kept clear of the building structure. Where it is within 1" of the building structure it shall be wrapped with felt (3/16" minimum thickness).
  5. To the greatest extent possible, domestic cold water piping shall be kept separated from hot piping and where there is a choice shall be run in the coolest portion of the available space.
- D. Natural Gas Piping Systems:
1. Natural gas piping shall slope back to meter where possible; bottom of vertical natural gas lines shall be fitted with 6" long capped drip legs.
  2. In addition to main shut-off valve, a natural gas stopcock shall be installed at each natural gas fired piece of equipment.
- E. PVC Piping
1. Because cements and primers are flammable, care shall be taken to avoid, sparks, heat or open flames in both work and storage areas. Avoid direct contact with eyes and skin. Proper ventilation is mandatory when working indoors.
  2. Temperature extremes are not conducive to good solvent cementing. Environments with temperatures above 110°F and below 40°F should be avoided.
  3. Pipes shall be cut square with a tubing cutter (no hack saws shall be used). Ends of pipe shall be beveled and deburred with a deburring tool.
  4. Pipe ends shall be cleaned with a dry rag and all foreign material shall be removed.
  5. Dissolve the inside socket of the fitting with appropriate primer by repeated strokes of a well wetted applicator. Dissolve the end surface of the pipe in a similar manner. Then, immediately apply a generous amount of cement to the outside of the pipe and a moderate amount of cement to the inside of fitting. Do not allow cement to puddle in fittings.
  6. Apply a second coat of cement to the outside of the pipe, and while both surfaces are still liquid, bottom the pipe into the fitting, rotating the pipe 90° if possible. Hold until the pipe will not push out.
  7. Wipe any excess cement from the pipe and observe the following cure times: 30 minutes at 60-100°F; 1 hour at 40-60°F; 2 hours at 20-40°F; and 4 hours at 0-20°.
- F. Plumbing Fixtures:
1. Space between wall mounted fixtures and wall surface shall be neatly pointed up with G.E. silicone rubber compound of color matching fixture.
  2. All exposed bolt heads and nuts used to secure fixtures shall be concealed with vitreous china caps.
- G. Flashing:
1. All roof and wall penetrations shall be flashed and counterflashed water tight with 26 gauge sheet metal, except as noted.
  2. Vents through roof shall be flashed with Semco #1100-4 lead flashing assemblies. Flashing shall be extended over top of pipe and shall be turned down inside top of pipe.
- H. Excavation, Backfill:

1. Provide all excavation, trenching, and backfill in connection with the work of this Section.
  2. Excavation shall be carried to 4" below the bottom of pipes. Provide a sand bedding for all sloped drainage piping, and provide smooth uniformly graded bedding of firm but yielding material for all other piping, catch basins, and similar structures.
  3. Backfill material shall be non-corrosive and free from all foreign material that could damage pipes. Installation shall be in accordance with "Earthwork" Section.
- I. Indirect Waste Piping:
1. Indirect waste piping shall be installed to a uniform minimum grade of  $\frac{1}{4}$ " per foot unless otherwise noted.
  2. Changes in direction of indirect waste piping shall be accomplished by the use of appropriate drainage fittings.
  3. Drilling and tapping of indirect waste pipes and the use of saddle hubs and bands are prohibited.
  4. Protection against breakage of piping passing under or through walls shall be provided using specified sleeves and caulking.
- J. Compressed Air Piping:
1. Install piping systems in accordance with the drawings and details. Pitch horizontal pipe in such a manner as to force moisture content of system with air flow to automatic moisture traps. Install air cocks ahead of all air outlets.
  2. Slope compressed air main lines in the direction of flow to a dirt pocket and automatic condensate trap, inverted type. Slope at  $\frac{1}{4}$ " per 10 feet.

### 3.17 TESTING, INSPECTIONS

- A. General:
1. This Contractor shall not allow or cause any work of this Section to be covered or enclosed until it has been inspected, tested, and approved by the Architect and the authorities having jurisdiction over the Work. Should any of this work be enclosed or covered up before such inspection, testing, and approval, this Contractor shall uncover the work, have the necessary inspections, tests, and approvals made and, at NO expense to the Owner, make all repairs necessary to restore both his work and that of other contractors which may have been damaged to be in conformity with the Contract Documents.
- B. Tests:
1. This Contractor shall make all tests required by all local, state, and federal laws, codes, ordinances, and regulations having jurisdiction over this work.
  2. Furnish all necessary labor, materials, and equipment for conducting tests, and pay all expenses in connection therewith. Should leaks develop while testing, repairs shall be made, and tests shall be repeated until a satisfactory test is obtained.
  3. Water Piping: Shall be hydrostatically tested for six (6) hours at 150 psi. All equipment shall be tested water tight at utility pressure.
  4. Drainage and Vent Piping: Shall be tested for (1) hour by plugging all outlets and filling the pipes with water to the top of vertical sections of pipes. No loss of water shall be permitted.
  5. Natural Gas Piping: Shall be tested for twenty-four (24) hours at a pressure of 50 psig with nitrogen or compressed air. NO pressure drop shall be allowed during the last four (4) hours of the test. Tests joints of natural gas piping with Leak-Tek or Nupro-Snoop solution while maintaining ten (10) psig minimum internal pressure.
  6. Compressed Air Piping Systems: Shall be tested with compressed air at 150 psig for six (6) hours. No pressure drop shall be allowed during the last four (4) hours of the test. Check for leaks with a soap solution.

### **3.18 DOMESTIC WATER SYSTEM STERILIZATION**

- A. Upon completion of this work, the new domestic water system shall be thoroughly flushed, sterilized and reflushed. Sterilization and reflushing shall be performed using the procedure below. All work shall be performed in the presence of the inspector.
- B. All domestic water outlets shall have signs posted at their location stating that the water has not been sterilized and shall not be used for human consumption. The signs shall remain until the sterilization process is complete.
- C. Procedure
  1. Introduce chlorine or a solution of sodium hypochlorite, filling the lines slowly and supplying the sterilization agent at a rate of 200 parts of chlorine per million. The entire system shall be completely filled with the solution. All valves shall be operated and ends of all branches tested for residual chlorine. Continue to inject the solution until at least 200 ppm of free chlorine is indicated.
  2. After the sterilizing agent has been applied, the system shall be isolated with the solution retained for at least 3 hours. Test for residual chlorine after retention. If less than 200 ppm is indicated, repeat the sterilization procedure.
  3. After satisfactory sterilization, flush the system until all traces of the chemical are removed or until the chlorine content is no greater than that in the existing supply.
- D. After a period of 48 hours minimum, bacteriological tests, using samples from at least 3 representative points, shall be made by recognized testing agency, who shall certify to the Architect that the system is bacteriologically safe and at least equal in safety to that of the principal water supply. The laboratory report and certification shall be transmitted to the Architect.

### **3.19 ADJUSTING**

- A. Properly adjust all stops, and controls, and demonstrate safe and satisfactory operation of all equipment.

### **3.20 CLEANING OF PIPING**

- A. All new piping shall be thoroughly cleaned of rust, scale, etc., prior to enclosing and placing in operation. Flush all water piping systems. Water shall be forced through pipes until the systems are free from foreign substances.
- B. Remove, clean and replace all strainer baskets prior to final inspection.
- C. Blow out all compressible fluid piping with compressed air before connecting with regulators or equipment.

### **3.21 CLEANUP**

- A. Upon completion of the work of this Section, remove all surplus material, debris, and equipment associated with or used in the performance of this work.

**END OF SECTION**

## SECTION 22 1100

### SITE WATER DISTRIBUTION

#### 1. PART 1 GENERAL

##### 1.1 RELATED DOCUMENTS

- A. Drawings and general provisions of the Contract, including General and Supplementary Conditions and Division 1 Specification Sections, apply to this Section.

##### 1.2 SUMMARY

- A. This Section includes site distribution piping outside buildings for water service, and the following components:
  - 1. Valves.
  - 2. Concrete thrust blocks.
  - 3. Cathodic Protection.
- B. Related Sections include:
  - 1. Section 31 2333 "Trenching and Backfill" for trenching and backfilling for underground water lines, and detectable warning tapes.
  - 2. Section 32 8000 "Irrigation System" for irrigation lines.
  - 3. Division 15 Section for water lines within and below buildings.
  - 4. Section 13 4713 "Cathodic Protection Systems."

##### 1.3 DEFINITIONS

- A. Water Main: Utility's water piping.
- B. Water Service: Site domestic water piping.
- C. Point of Delivery: Piping outlet from water meter.
- D. DN: Dimension Nominal.
- E. NPS: Nominal Pipe Size.
- F. PVC: Polyvinyl chloride plastic

#### **1.4 SUBMITTALS**

- A. Product Data: For each type of product, including the following:
  - 1. Piping and related specialties.
  - 2. Valves and accessories.
  - 3. Valve boxes.
  - 4. Cathodic Protection Design.
- B. Shop Drawings: For the following:
  - 1. Precast concrete utility boxes, including frames and covers.
  - 2. Protective enclosures for backflow preventer.
  - 3. Cathodic Protection Design.
- C. Coordination Drawings: For piping and specialties including relationship to other services in same area. Show piping and specialty sizes and valves, meter and specialty locations, and elevations.
- D. Field Quality-Control Test Reports: From Contractor.
- E. Operation and Maintenance Data: For specialties to include in emergency, operation, and maintenance manuals. In addition to items specified in Division 1 Sections for closeout procedures and operation and maintenance data, include the following:
  - 1. Valves.
  - 2. Backflow preventers
  - 3. Protective enclosures.
  - 4. Cathodic Protection.
- F. Record drawings of installed water service lines and appurtenances in accordance with Division 1 Section for project closeout requirements.
  - 1. Locate and dimension work with reference to permanent landmarks. Indicate materials and sizes of all components.

#### **1.5 QUALITY ASSURANCE**

- A. Product Options: Drawings indicate size, profiles, and dimensional requirements of piping and specialties and are based on the specific system indicated. Refer to Division 1 Section for product requirements.
- B. Regulatory Requirements:
  - 1. Comply with requirements of the City of Brentwood. Include tapping of water mains and backflow prevention.

2. Comply with standards of the City of Brentwood for potable-water-service piping, including materials, installation, testing, and disinfection.
- C. Piping materials shall bear label, stamp, or other markings of specified testing agency.
- D. NSF Compliance:
  1. Comply with NSF 14 for plastic potable-water-service piping.
  2. Comply with NSF 61 for materials for water-service piping and specialties for domestic water.
- E. Cathodic Protection System Design:
  1. Cathodic protection system design will be performed and stamped by a qualified Corrosion Engineer. This person shall be responsible for the design, supervision, inspection and testing of the cathodic protection system.
  2. Qualifications of the Corrosion Engineer shall be submitted to the owner for approval prior to commencement of work.

#### **1.6 DELIVERY, STORAGE, AND HANDLING**

- A. Preparation for Transport: Prepare valves according to the following:
  1. Ensure that valves are dry and internally protected against rust and corrosion.
  2. Protect valves against damage to threaded ends and flange faces.
  3. Set valves in best position for handling. Set valves closed to prevent rattling.
- B. During Storage: Use precautions for valves, according to the following:
  1. Do not remove end protectors unless necessary for inspection; then reinstall for storage.
  2. Protect from weather. Store indoors and maintain temperature higher than ambient dew-point temperature. Support off ground or pavement in watertight enclosures when outdoor storage is necessary.
- C. Handling: Use sling to handle valves if size requires handling by crane or lift. Rig valves to avoid damage to exposed parts. Do not use handwheels or stems as lifting or rigging points.
- D. Deliver piping with factory-applied end caps. Maintain end caps through shipping, storage, and handling to prevent pipe-end damage and to prevent entrance of dirt, debris, and moisture.
- E. Protect stored piping from moisture and dirt. Elevate above grade. Do not exceed structural capacity of floor when storing inside.
- F. Protect flanges, fittings, and specialties from moisture and dirt.

- G. Store plastic piping protected from direct sunlight. Support to prevent sagging and bending.

## 1.7 PROJECT CONDITIONS

- A. Do not interrupt existing utilities serving facilities occupied by Owner or others unless permitted under the following conditions and then only after arranging to provide temporary utility services according to requirements indicated:
  - 1. Notify Architect not less than five working days in advance of proposed utility interruptions.
  - 2. Do not proceed with utility interruptions without Architect's written permission.
- B. Information shown regarding locations of existing utilities is based upon available records and data, but shall be regarded as approximate, only. Make minor deviations necessary to conform to actual locations and conditions without extra cost. Verify location and elevation of utilities prior to commencement of excavation.
  - 1. Exercise extreme care in excavating near existing utilities. Locations of existing utilities are approximate. It is the contractor's responsibility to verify the location and depth with the appropriate agencies prior to construction. Contractor is responsible for damage to existing utilities.

## 1.8 COORDINATION

- A. Coordinate connection to water main with City of Brentwood.
- B. Coordinate installation of required supporting devices and set sleeves in poured-in-place concrete and other structural components as they are constructed.
- C. Coordinate placement of valve boxes with layout of paving joints and patterns. Refer to Drawings for layout.
- D. Coordinate crossings with other underground utilities.
- E. Coordinate with locations of building connections.

## 2. PRODUCTS

### 2.1 PIPING MATERIAL

- A. Refer to Part 3 "Piping Applications" Article for applications of pipe, fitting, and joining materials.

### 2.2 PVC PIPE AND FITTINGS

- A. Polyvinyl Chloride Pipe (PVC) shall be furnished in the classes, sizes and grades designated on the plans. All Class 150 pipe shall meet the requirements of DR 18 and Class 200 pipe shall meet the requirements of DR 14 with cast iron O.D.



1. Pipe Sizes 4-in. to 8-in. Diameter:
    - (a) Polyvinyl Chloride (PVC) per requirements of ANSI/AWWA C900.
    - (b) Pipe shall be Class 150 for main and fire hydrant lines and class 200 for fire service lines.
  2. Pipe Sizes 4-in. Diameter and Smaller:
    - (a) Polyvinyl Chloride (PVC) per requirements of NSF/ANSI Standards 14 and 61.
- B. Joints and Fittings: All pipes shall be suitable for use as a pressure conduit.
1. Provisions shall be made for expansion and contraction at each joint with an "O" ring elastomeric gasket seal meeting requirements of ASTM D1869 and F477.
  2. Solvent welded joints are prohibited.
  3. Bell sections shall be designed to be at least as strong as the pipe wall.
  4. All fittings for PVC pipe shall be cast iron only.
  5. All mechanical joints on fire service lines and fire sprinkler laterals shall be coated and wrapped.

## 2.3 JOINING MATERIALS

- A. AWWA Transition Couplings:
1. Manufacturers: Subject to compliance with requirements, provide products by one of the following:
    - (a) Cascade Waterworks Manufacturing Company.
    - (b) Dresser Industries, Inc.; DMD Division.
    - (c) JCM Industries.
    - (d) Viking Johnson.
    - (e) Manufacturer of equal products in accordance with Division 1 requirements for product substitutions.
- B. Pipe Flange Gasket Materials: Suitable for chemical and thermal conditions of piping system contents.
1. AWWA C110, rubber, flat face, 1/8-inch thick, unless otherwise indicated; and full-face or ring type, unless otherwise indicated.
- C. Flange Bolts and Nuts: ASME B18.2.1, carbon steel, unless otherwise indicated.
- D. Plastic Pipe Flange Gasket, Bolts, and Nuts: Type and material recommended by piping system manufacturer, unless otherwise indicated.

## 2.4 GATE VALVES

### A. Gate Valves:

1. Gates Valves for 4-in through 8-in diameter pipe.
  - (a) Use resilient seated gate valves per AWWA C509.
  - (b) Valve ends shall be mechanical joint or flanged per AWWA C500 unless otherwise specified.
  - (c) Valves for use with flanged pipe shall be cast with Class 125 flanges, dimensions and drilling shall be per ASA B16.1. Flange bolt holes shall be spot faced if flange fillets interfere with bolt heads and nuts.
  - (d) The inlet flange for tapping gate valves shall be provided with Class 125 flange for attaching to tapping sleeve. The flange shall have a machined projection compatible with a machined recess in the tapping sleeve. The outlet of the valve shall be provided with a flange for tapping machine mounting. Tapping sleeve shall be mechanical joint and flange unless deviation is permitted by the engineer.
  - (e) All stem seals for gate valves shall be "O" rings only.
  - (f) Wrench nuts shall be made of top grade cast iron, fitting the top of the valve stem and secured by nut or key. Wrench nuts shall be 1-15/16-in. square at the top and 2-in. square at the bottom.
  - (g) Valves requiring operating wrench exceeding 60 inches in length shall have extensions and guides installed in valve boxes.
  - (h) The open direction shall be left (counterclockwise) and the closed direction right (clockwise).
2. Manufacturers: Subject to compliance with requirements, provide products by one of the following:
  - (a) Crane Co.; Crane Valve Group; Stockham Division.
  - (b) NIBCO INC.
  - (c) Manufacturer of equal products in accordance with Division 1 requirements for product substitutions.
3. Non-rising Stem Gate Valves:
  - (a) Description: Class 125, Type 1, bronze with solid wedge, threaded ends, and malleable-iron handwheel.
    - (1) Standard: MSS SP-80.

## 2.5 VALVE ACCESSORIES AND SPECIALTIES

### A. Valve Boxes

1. All valve boxes shall conform to City of Brentwood Detail No. W-13.
2. Lids shall have machined seating surfaces.
3. Valve box risers shall be manufactured for the valve box supplied. Riser to be one continuous piece and centered on valve. Should be riser or 8-in.  $\varnothing$ , Class 100 PVC.

### B. Bolts, Nuts & Washers.

1. Bolts and nuts for flanges and fittings shall be Stainless Steel (SS) 304 or 316 per ASTM A320, alloy steel and stainless steel bolting materials for low temperature service.
2. Washers shall be Stainless Steel 304 or 316 to match their adjoining bolts and nuts.

### C. Gaskets

1. Gaskets for flanged joints shall be 1/16-in. thick cloth inserted rubber per applicable parts of ANSI B16.12, AWWA C115 and AWWA C207.
2. Gasket material shall be free from corrosive alkali or acid ingredients and suitable for use in potable water lines.
3. Gaskets shall be one piece, full face, with holes to accommodate bolts.
4. Gaskets for push-on joints shall be oil resistant per AWWA C111. Lubricant for push-on joints piping shall be pipe manufacturer's standard.

### D. Thrust Blocks

1. All thrust blocks for water lines shall conform to City of Brentwood Detail No. W-15.
2. Thrust blocks shall be included at all water mains and fire services where changes in direction occur.

## 2.6 MISCELLANEOUS MATERIALS

### A. Portland Cement Concrete: Minimum compressive strength of 3000 psi, minimum of four sacks of cement per cubic yard of concrete, one-Inch maximum aggregate size, three-inch maximum slump, two to four percent entrained air.

1. Cement: ASTM C 150, Type I.
2. Fine Aggregate: ASTM C 33, sand.
3. Coarse Aggregate: ASTM C33, crushed gravel.

4. Water: Potable.

## **2.7 CATHODIC PROTECTION**

- A. See Section 13 4713 "Cathodic Protection Systems."
- B. Materials and workmanship shall be in accordance with all applicable state and local codes. Corrosion protection shall be installed in accordance with manufacturer's instructions.
- C. All ferrous metal fittings shall be coated and wrapped for cathodic protection in accordance with Corrosion Engineer recommendations and Owner requirements.

## **3. PART 3 EXECUTION**

### **3.1 EXCAVATION AND BACKFILL**

- A. Refer to Section 31 2000 "Earthwork" for excavation, trenching and backfilling.

### **3.2 PIPING APPLICATIONS**

- A. General: Use pipe, fittings, and joining methods for piping systems according to the following applications.
- B. Transition couplings and special fittings with pressure ratings at least equal to piping pressure rating may be used in applications below, unless otherwise indicated.
- C. Do not use flanges, unions, or keyed couplings for underground piping.
- D. Flanges, unions, keyed couplings, and special fittings may be used, instead of joints indicated, on piping in utility boxes and vaults.
- E. Underground Water Service Piping: Use the following piping materials for each size range:
  1. NPS 3/4 to NPS 1-1/2 (DN 20 to DN 40): PVC (IPS); PVC socket fittings and solvent-cemented joints.
  2. NPS 2 to NPS 3 (DN 50 to DN 80): PVC (IPS); PVC gasketed fittings.
  3. NPS 4 and Larger: PVC, AWWA Class 150 pipe; PVC, AWWA Class 150 molded fittings; and gasketed joints.
- F. Aboveground Water Service Piping: Ductile iron pipe with grooved ends; ductile iron, grooved end fittings; ductile iron keyed couplings; and grooved joints.

### **3.3 VALVE APPLICATIONS**

- A. General Application: Use threaded or flanged end valves for underground installation, as suitable for piping in which valve is installed. Install AWWA, cast-iron, non-rising stem, resilient-seated gate valves with valve box.

### 3.4 PIPING INSTALLATION

- A. Drawing plans, schematics, and diagrams indicate general location and arrangement of water-service piping systems. Indicated locations and arrangements were used to size pipe and calculate friction loss, expansion, and other design considerations. Install piping as indicated unless deviations to layout are approved on Coordination Drawings.
- B. Water-Main Connection: Arrange with City of Brentwood for all connections to the water main.
- C. Install ductile iron, water-service piping according to AWWA C600 and AWWA C105.
- D. Install PVC pipe according to AWWA M23 and ASTM F 645.
- E. Select system components with pressure rating equal to or greater than system operating pressure.
- F. Remove scale, slag, dirt, and debris from inside and outside of pipe and fittings before assembly.
- G. Install piping to permit valve servicing.
- H. Install water service piping free of sags and bends.
- I. Install fittings and thrust blocks for changes in direction and branch connections.
- J. Install sleeves for pipes passing through concrete and masonry walls and foundations.
- K. Unless indicated otherwise, bury piping with depth of cover over top at least 36 inches.
  - 1. In Loose Gravelly Soil and Rock: With at least 12 inches additional cover.
- L. Install piping by tunneling, jacking, or combination of both, under streets and other obstructions that cannot be disturbed.
- M. Restrained Joints: Install concrete thrust blocks per NFPA 24 at all horizontal and vertical changes in direction.
  - 1. Install concrete thrust blocks at all pipe tees, wyes, bends, crosses, elbows, and risers (valves).
  - 2. Thrust blocks to bear against undisturbed soil, and sized as indicated.
  - 3. Place thrust blocks so that pipe joints are accessible for inspection and repair.
- N. Install water-supply piping with shutoff valve in water supply to each building. Use gate valve and valve box.

### 3.5 JOINT CONSTRUCTION

- A. Make pipe joints according to the following:

1. Ductile-Iron Piping, Gasketed Joints for Water-Service Piping: ANSI A21.11 (AWWA C111).
2. PVC Piping Gasketed Joints: Use joining materials according to AWWA C900. Construct joints with elastomeric seals and lubricant according to ASTM D 1869 and F477 and pipe manufacturer's written instructions.
  - (a) PVC Piping Solvent-Cement Joints: Solvent Joints are prohibited.
3. Dissimilar Materials Piping Joints: Use adapters compatible with both piping materials, with OD, and with system working pressure.

### 3.6 VALVE INSTALLATION

- A. All valves within public right-of-way shall conform to City of Brentwood Detail No. W-13 as shown on the plans.
- B. AWWA Gate Valves: Comply with AWWA C509. Install each underground valve with stem pointing up and with valve box.
- C. Center valve box on valve, setting plumb and level.
  1. Install valve box extensions as required to extend down to level of piping.
  2. Compact soil backfill around valve box to a distance of 4 feet on all sides.

### 3.7 CONNECTIONS

- A. Connect water service piping at water supply source and extend to point of connection to building water piping systems at 5 feet outside face of building wall in locations and pipe sizes indicated.
  1. Terminate water service piping at 5 feet to building wall until building water piping systems are installed. Terminate piping with caps, plugs, or flanges as required for piping material. Make connections to building water piping systems when those systems are installed.
  2. Refer to Division 15 Section for potable-water piping below and within buildings.
- B. Connections to Valves and Equipment: Except as otherwise indicated, make piping connections as follows:
  1. Install unions adjacent to each valve and at final connection to each piece of equipment having threaded pipe connection.
  2. Install flanges adjacent to each valve and at final connection to each piece of equipment having flanged pipe connection.

**3.8 IDENTIFICATION**

- A. All non-metallic water mains shall have a No. 10 gauge solid, coated, copper wire laid along the pipe, accessible in each valve box or other access opening to the system. Wire splices shall be field soldered.

**3.9 PROTECTIVE ENCLOSURE INSTALLATION**

- A. Install concrete slab base level and with top approximately two inches above grade.
- B. Install protective enclosure over valves and equipment.
- C. Anchor protective enclosure to concrete base.

**3.10 CATHODIC PROTECTION**

- A. See Section 13 4713 "Cathodic Protection Systems".
- B. All buried ductile iron pipes, steel or ductile iron connection fittings, and metal valves shall be corrosion protected in accordance with the recommendations provided by the Corrosion Engineer.
- C. Corrosion protection shall be installed in accordance with manufacturer's instructions.

**3.11 FIELD QUALITY CONTROL**

- A. Water Main Disinfection: Refer to Refer to City of Brentwood Standard Specification Section 130-1.03B1 "Testing" and Section 130-1.03C "Disinfecting Water Mains" for cleaning procedures and requirements.
- B. Prepare reports of testing activities.

**3.12 CLEANING**

- A. Water Main Disinfection: Refer to City of Brentwood Standard Specification Section 130-1.03C "Disinfecting Water Mains: for cleaning procedures and requirements.
- B. Prepare reports of testing activities.

**END OF SECTION 22 1100**

## SECTION 23 0000

### HEATING, VENTILATING, AIR CONDITIONING

#### PART 1 GENERAL

##### 1.01 DESCRIPTION

- A. This Specification establishes the required standards for all labor, materials, equipment and workmanship in connection with the furnishing, fabrication and installation of complete "Heating, Ventilating, Air Conditioning" systems. Heating, ventilating, air conditioning work includes, but is not necessarily limited to, the following:
1. Split system VRV heat pump units with heat recovery;
  2. Split system air conditioning, cooling only;
  3. Packaged rooftop air conditioning;
  4. Energy recovery ventilators;
  5. Roof mounted kitchen hood exhaust fans;
  6. Ceiling mounted exhaust fans;
  7. Make up air units;
  8. Air terminals;
  9. Linear slot diffusers;
  10. Thermal and sound insulation for all piping and ductwork supplied under this Section;
  11. Refrigerant piping and appurtenances;
  12. Ductwork, inclusive of all air turns, dampers, grilles, diffusers, fire dampers, sound traps, supports, bracing and fresh air/combustion air ducts;
  13. Flashings, curbs and caps in connection with all equipment, piping and ductwork supplied under this Section;
  14. Temperature control wiring and control devices;
  15. Start up, adjusting, and balancing.
- B. The Contractor shall furnish all materials and labor under the scope of the Contract, unless otherwise noted. Anything accepted as standard trade practice reasonably incidental to the completion of the system shall be furnished without additional cost to the Owner. The Contractor shall understand that the work herein described shall be complete in every detail, notwithstanding every item necessarily involved is not particularly mentioned, and the Contractor shall be held to provide all labor and material necessary for the entire completion of the work.
- C. Comply with applicable requirements in ASHRAE 62.1 and ASHRAE 90.1

##### 1.02 RELATED SECTIONS

- A. Section 23 0500 - General Mechanical
- B. Section 07 6000 - Sheet metal flashing and trim.
- C. Domestic water piping: Section 22 0000 - Plumbing.
- D. Line voltage wiring, disconnect switches, conduit for temperature control wiring, and final connection of electrical equipment: Division 26.
- E. Finish painting: Division 09.
- F. Condensate drainage piping to points adjacent to equipment: Section 22 0000 - Plumbing.
- G. HVAC Controls: Section 23 0923 - Energy Management System for HVAC.



H. Air Balancing: Section 23 0593, Testing, Adjusting and Balancing of HVAC

**1.03 SUBMITTALS**

- A. All submittals shall be in accordance with the requirements of the General Conditions, Division 01 Sections, and per the following.
- B. Product Data
  - 1. For all HVAC equipment and each type of product indicated, include manufacturer's specifications, data sheets, and certified drawings on major equipment. Include physical and performance data, such as weights, sizes, capacities, required clearances, performance curves, acoustical characteristics, finishes, color selection, and accessories.
  - 2. Include certified drawings on major equipment.
- C. Coordinated Layout/Shop Drawings
  - 1. Prepare complete consolidated and coordinated layout drawings for all new systems, and for existing systems that are in the same areas. Shop drawings shall be prepared using AutoCAD 2014 or newer and shall be drawn at a minimum  $\frac{1}{4}'' = 1' - 0''$  scale.
  - 2. All drawings shall be fully coordinated with HVAC, Plumbing, Fire Protection, Electrical, Structural, and Architectural work. Drawings shall be coordinated and dimensioned indicating equipment, pipe, duct, fire protection, and electrical in relation to architectural and structural features. Indicate exact locations of valves, piping specialties, access doors, etc.
  - 3. Clearly identify and dimension the proposed locations of the principal items of equipment and adequate clearance for all equipment, piping, pumps, valves and other items. Provide detailed layout of all piping systems showing the proposed routes.
  - 4. Show the access means for all items requiring access for operations and maintenance.
  - 5. Submit shop drawings to Architect for approval, prior to fabrication or installation of any work. Do not install equipment or piping until layout drawings have been approved. Any work installed without prior shop drawing approval shall be removed at the Contractor's expense.
  - 6. Use of contract documents for shop drawings is not acceptable.
- D. Shop-wiring diagrams of temperature controls and air conditioning unit controls.
- E. Equipment manufacturer shall design, construct, and certify that his equipment satisfies the special minimum seismic resistance requirements for this project and shall submit calculations or test results supporting his certification.
- F. Field quality-control test reports.
- G. Operation and maintenance data
  - 1. Contractor shall provide all operating and maintenance instructions provided by the manufacturer, describing proper operation and maintenance of any equipment and devices installed. Operating and maintenance instructions shall cover maintenance, adjustment, and operation of each piece of apparatus.
  - 2. Contractor shall also provide a parts list of all equipment and component parts for all equipment under this Section. The equipment list shall include manufacturer's name, model number, and local representative, service facilities and normal channel of supply for each item.
  - 3. Data shall include a table of contents identifying items therein, and index tabs for each system. Neatly obscure or cross out inapplicable data from manufacturer's literature. Include the following:
    - a. Manufacturer's brochures, ratings, certified shop drawings, lubrication charts and data, and parts list with part numbers. Mark each sheet with equipment

- identification number and actual installed condition or system and location of installation. Specifically identify which options are provided.
  - b. Description of start-up and operating procedures for each system, including controls diagrams and description of operating sequences.
  - c. Recommend preventative maintenance schedule and procedures.
  - 4. Submit data to the Architect for approval. Final acceptance of the work will not be made until a satisfactory submission of this material is received and approved by the Architect.
- H. As-Built Drawings
- 1. Complete and detailed shop drawings shall be maintained throughout the coordination and construction phase, indicating all equipment and trades' work clearly. All equipment including piping, etc. shall clearly identify both top and bottom elevations as well as distances from equipment to established building lines. Coordinate with other trades and field conditions and show dimensions and details including building construction and access for servicing. All changes in the work shall be recorded on this set on a daily basis. In addition to changes made during course of work, show the following:
    - a. Exact location, type and function of concealed valves and controllers.
    - b. Exact size, elevations and location of underground and under floor piping.
  - 2. Submit to Architect for approval.
- I. Warranty
- 1. Equipment warranties shall be provided for all equipment, with all necessary information filled in, except purchase date, in favor of the Owner.
- J. Refer to mechanical equipment specified herein for additional requirements

#### 1.04 DEMONSTRATION & TRAINING

- A. The Owner's authorized representative shall be instructed in the operation and servicing of all heating, ventilating, and air conditioning systems, subsystems and equipment.
  - 1. Provide a minimum of one day of instruction time. All instruction shall be provided at no cost to the Owner.

#### PART 2 PRODUCTS

- A. Refrigerant piping shall be Type "ACR" ASTM B 280, drawn temper, seamless copper tube.
- B. Pipe fittings and unions shall be wrought-copper with brazed joints. ASME B16.22. Mechanical joints on refrigerant piping are prohibited. All refrigerant piping joints shall be brazed with lead-free silver brazing alloy, minimum 15% silver content. Harris "Stay Silv 15" or equal.
- C. Flexible connectors shall be bronze, double braided, with inlet and outlet connections as required. Metraflex BBS series or equal.
- D. Sight glasses shall be color change moisture indication type, replaceable element, filter screen and pad, sweat solder ends; Sporlan "See-All", Henry, or equal.
- E. Charging and purge valves shall be forged brass, diaphragm packless, globe type, angle or straight through, one end solder, one end flare; Henry 623 and 643 series, Sporlan, or equal.
- F. Solenoid valves shall be of forged brass, extended solder end connections, molded coil; Sporlan "E" series or equal. ARI 760 & UL 429
- G. Filter driers shall be replaceable media, angle type; Henry "Dri-Cor" or equal; ARI 730.
- H. Electronic thermostatic expansion valves shall have stainless steel body and connections, ceramic slide and port, linear flow capacity, continuous modulation, and direct coupling of

motor and valve; Emerson "EX" series or equal.

- I. Pipe hangers: All refrigerant piping shall be supported 8' on center. Hangers and supports shall be as specified in Section 23 0500 - General Mechanical".
- J. Split system fan-coil units and heat pump units shall have brazed sweat-fitting connections on the refrigerant piping between the units with a flexible piping section at the outdoor unit.

## 2.02 FILTERS

- A. Unless indicated otherwise on the equipment schedule, air filters shall be as follows. Filters shall be 2" completely disposable type with fiberglass media, AAF/Flanders "Pre-Pleat M13", Camfil "AP-Thirteen", or approved equal, UL Class 2 listed. Permanent washable types are not acceptable. Change filters at job completion and furnish one complete filter change boxed at the jobsite for owner.
- B. Each filter shall consist of synthetic only media, with corrosion-resistant expanded metal backing and moisture resistant enclosing frame. The filter shall be 2" nominal depth. The grid shall be 100% bonded to the media on the air exiting side to eliminate media vibration and pull-away.
- C. The grid shall be formed to provide a uniform V-wedge shaped pleat with the open area on the air exiting side for maximum utilization of the media and low airflow resistance. The filter shall be classified for flammability by Underwriters Laboratories, Standard 900 as Class 2.
- D. The filter shall have a Minimum Efficiency Reporting Value (MERV) of 13 by ASHRAE Standard 52.2.
- E. During construction, protect all filters upstream of air handling units with blankets of 2" fiberglass filter media or 2" disposable panel filters. UL Class 2 listed. Remove after balancing, and prior to acceptance.
  - 1. Filters to be provided during construction, upstream of air handling units, at return grilles, or any other return duct openings shall be Camfil "30/30" pleated panel filters, AAF/Flanders, or approved equal. MERV 8
- F. Systems shall not be operated without properly installed filters, including temporary filters for use during construction. If the final pressure drop of the temporary filters is reached during construction or during test and balance, replace them with the spare set. If not used, the spare set is to be delivered to the Owner at the time of acceptance.

## 2.03 ROOF MOUNTED UPBLAST KITCHEN EXHAUST FAN

- A. Greenheck "CUE" series, direct drive, roof upblast centrifugal exhaust fan, as scheduled on the Drawings or approved equal. Each fan shall bear a permanently affixed manufacturer's engraved metal nameplate containing the model number and individual serial number.
- B. Fan Wheel
  - 1. The fan wheel shall be constructed of aluminum, and non-overloading, backward inclined centrifugal type. The wheel shall be statically and dynamically balanced in accordance to AMCA Standard 204-05.
  - 2. The wheel cone and fan inlet shall be matched with precise running tolerances.
- C. Electronically Commutated Motor (Varigreen)
  - 1. Motor enclosures shall be open type
  - 2. Motor to be a DC electronic commutation type (ECM). AC induction type motors are not acceptable.
  - 3. Motors shall be permanently lubricated, heavy duty ball bearing type to match with the

- fan load and pre-wired to the specific voltage and phase.
  - 4. Motor shall have internal motor circuitry to convert AC power supplied to the fan to DC power to operate the motor.
  - 5. Motor shall be speed controllable down to 20% of full speed (80% turndown). Speed shall be controlled by a potentiometer dial mounted at the motor.
  - 6. Motor shall be a minimum of 85% efficient at all speeds.
  - 7. Motor Cover shall be constructed of aluminum
- D. Housing
- 1. Housing shall be constructed of heavy gauge aluminum, including exterior housing, curb cap, windband, and motor compartment housing. The housing shall have a rigid internal support structure.
  - 2. Windband shall be one piece, of spun aluminum and shall maintain original material thickness throughout the housing. Windband shall include an integral rolled bead.
  - 3. Curb cap base shall be fully welded to windband to ensure a leak proof construction. Tack welding, bolting, and caulking are not acceptable. Curb cap to have integral deep spun inlet venturi and pre-punched mounting holes to ensure correct attachment to curb.
  - 4. Drive frame assemblies shall be constructed of heavy gauge steel and mounted on vibration isolators. Vibration Isolation shall be double studded true isolators, with no metal to metal contact, and sized to match the weight of each fan.
  - 5. Breather tube shall be 10 square inches in size for fresh air motor cooling and designed to allow wiring to be run through it.
- E. Disconnect switches shall be NEMA 1 rated, positive electrical shut-off, and shall be wired from fan motor to junction box installed within motor compartment.
- F. Drain trough shall allow for one-point drainage of water, grease and other residues.
- G. Options/Accessories
- 1. UL 705 listed

#### **2.04 ROOF MOUNTED KITCHEN EXHAUST FAN**

- A. Greenheck CUBE series belt-driven, roof upblast centrifugal exhaust fans, as scheduled on the Drawings or approved equal. Each fan shall bear a permanently affixed manufacture's engraved metal nameplate containing the model number and individual serial number.
- B. The fan wheel shall be non-over-loading, backward inclined centrifugal type, constructed of aluminum and with a non-stick (Teflon) coating. The wheel shall be statically and dynamically balanced in accordance to AMCA Standard 204-05. The wheel cone shall be matched to the inlet cone with precise running tolerances.
- C. Motor enclosures shall be open drip-proof. The motor shall be VFD rated, NEMA premium efficient, meeting NEMA Table 12-12. The motor enclosure shall be open drip-proof. Motors shall be heavy-duty ball bearing type, matched to the fan load. Motors shall be mounted on vibration isolators, out of airstream. Fresh air for motor cooling shall be drawn into the motor compartment through an area free of discharge contaminants. Motors shall be readily accessible for maintenance.
- D. Fan shafts shall be ground and polished solid steel with an anti-corrosive coating. Bearings shall be pillow block ball bearings, 100% factory tested, and selected for a minimum L10 life in excess of 100,000 hours at maximum cataloged operating speed. The fan shaft first critical speed shall be at least 25% over maximum operating speed.
- E. Fan housing shall be constructed of heavy gauge aluminum, including curb cap, windband and motor compartment. Housing shall have a rigid internal support structure. The windband

shall be one-piece with consistent thickness and shall have an integral rolled bead for added strength. The curb cap base shall be fully welded to windband to ensure that it is leakproof. The cap shall have an integral deep spun inlet venturi and pre-punched mounting holes for correct attachment to curb. Drive frame assemblies shall be constructed of heavy gauge steel and mounted on vibration isolators. A breather tube shall be 10 square inches in size for fresh air motor cooling and designed to allow wiring to be run through it.

- F. A positive electrical shut-off disconnect switch shall be wired from the fan motor to the junction box installed within motor compartment. The switch shall be mounted in a NEMA 1 rated enclosure.
- G. The drive assembly shall include belts, pulleys, and keys oversized for a minimum of 150% of driven horsepower. The pulleys shall be fully machined cast iron type, keyed and securely attached to the wheel and motor shafts. The belts shall be static free and oil resistant. The motor pulley shall be adjustable for final system balancing.
- H. A drain trough shall allow for one-point drainage of water, grease, and other residues.
- I. All fans shall be certified to bear the AMCA label for sound and air performance. Fans shall be Listed by Underwriters Laboratory for UL 762 Listed for all electrical components and grease removal.
- J. Options to be provided:
  - 1. Fan and attached accessories shall be coated with "Permatector", concrete gray-RAL 702.
  - 2. Clean-out Port: A removable grease repellent compression rubber plug shall be provided as a clean-out port to allow access for cleaning the wheel through the windband.
  - 3. Grease trap with drain connection and grease absorbent sock. Drain connection shall be constructed of aluminum, and shall allow single point collection of grease, water or other residues.
  - 4. Heat baffle: 1" thick insulation shield that prevents heat from radiating into the motor compartment.
  - 5. UL 762 Listed
  - 6. Variable Frequency Drive: "Vari-Green Drive Model 100 or 100+". Motor shall be MVFD rated. VFD shall be factory programmed, mounted, and wired. The drive shall be variable speed and mounted in a NEMA 4X enclosure. An LED indicates Power, Run, and Fault. R3 filtering technology mitigates harmonics to levels in compliance with IEEE 519 without the use of external reactors.

## 2.05 CEILING MOUNTED EXHAUST FANS

- A. Panasonic "WhisperGreen Select" series, model FV-0511VKS2, customizable ceiling mounted ventilation fans, as scheduled on the Drawings or approved equal. The fans shall be "Energy Star" rated with multi-speed control.
- B. Motor/Blower
  - 1. The removable permanently lubricated plug-in motor shall be enclosed, brushless ECM type, rated for continuous operation. The ventilation rates shall be adjustable at 50-80-110 CFM (FV-0511VK2) and 110-130-150 CFM (FV-1115VK2).
  - 2. Power rating shall be 120 volts and 60 Hz.
  - 3. The motor shall be equipped with a thermal cutoff fuse.
- C. Housing shall be of 26-gauge Zinc-Aluminum-Magnesium (ZAM) and have an integrated dual 4" or 6" duct adapter. The duct diameter shall be no less than 4". The housing shall have a built-in metal flange and a built-in backdraft damper. An expandable installation bracket (up to 24") is provided with fan.

- D. The grille shall be of PolyPro material and shall attach directly to the housing with torsion springs.
- E. Provide the following Plug 'N Play™ modules:
  - 1. FV-MSVK1: Motion Sensor
    - a. Automatically activates when someone enters the room. Once the settings have been applied, the fan becomes truly automatic. This module also activates a 20-minute delay off timer for the fan.

## 2.06 SPLIT SYSTEM VRF UNITS

- A. The variable capacity, heat pump heat recovery air conditioning systems shall be a Mitsubishi Electric CITY MULTI VRF (Variable Refrigerant Flow) zoning systems or approved equal Daikin, or Panasonic, or Hitachi. Simultaneous heating/cooling (heat recovery) systems shall consist of an "TURY" outdoor unit, BC (Branch Circuit) Controller, "PEFY" and "PLFY" series indoor units, an integral DDC (Direct Digital Controls) system.
- B. Each indoor unit or group of indoor units shall be capable of operating in any mode independently of other indoor units or groups. System shall be capable of changing mode (cooling to heating, heating to cooling) with no interruption to system operation. To ensure owner comfort, each indoor unit or group of indoor units shall be independently controlled and capable of changing mode automatically when zone temperature strays 1.8° F from set point for 10 minutes.
- C. Quality Assurance
  - 1. The units shall be listed by Electrical Testing Laboratories (ETL) and bear the ETL label.
  - 2. All wiring shall be in accordance with the National Electrical Code (N.E.C.).
  - 3. The units shall be manufactured in a facility registered to ISO 9001 and ISO14001 which is a set of standards applying to environmental protection set by the International Standard Organization (ISO).
  - 4. All units must meet or exceed the 2010 Federal minimum efficiency requirements and the proposed ASHRAE 90.1 efficiency requirements for VRF systems. Efficiency shall be published in accordance with the DOE alternative test procedure, which is based on the Air-Conditioning, Heating, and Refrigeration Institute (AHRI) Standards 340/360, 1230 and ISO Standard 13256-1.
  - 5. A full charge of R-410A for the condensing unit only shall be provided in the condensing unit.
- D. Warranty
  - 1. The units shall be covered by the manufacturer's limited warranty for 1 year from date of installation.
    - a. If the systems are:
      - 1) designed by a certified CITY MULTI Diamond Designer,
      - 2) installed by a contractor that has successfully completed the Mitsubishi Electric 3-day service course, AND
      - 3) verified with a completed commissioning report submitted to and approved by the Mitsubishi Electric Service Department,
    - b. then the units shall be covered by an extended manufacturer's limited warranty for 5 years from date of installation.
  - 2. In addition, the compressor shall have a manufacturer's limited warranty for a period of 7 years from date of installation.
  - 3. If during this period any part should fail to function properly due to defects in workmanship or material, it shall be replaced or repaired at the discretion of the manufacturer.

4. This warranty shall not include labor.

E. General:

1. Manufacturer shall have a minimum of twenty-nine years of HVAC experience in the U.S. market.
2. All manufacturer technical and service manuals must be readily available for download by any local contractor should emergency service be required. Registering and sign-in requirements which may delay emergency service reference are not allowed.
3. The CITY MULTI VRF system shall be installed by a contractor with extensive CITY MULTI install and service training. The mandatory contractor service and install training should be performed by the manufacturer.

F. Controls

1. The control system shall consist of a low voltage communication network of unitary built-in controllers with on-board communications and a web-based operator interface. A web controller with a network interface card shall gather data from this system and generate web pages accessible through a conventional web browser on each PC connected to the network. Operators shall be able to perform all normal operator functions through the web browser interface.
2. System controls and control components shall be installed in accordance with the manufacturer's written installation instructions.
3. System shall provide direct and reverse-acting on and off algorithms based on an input condition or group conditions to cycle a binary output or multiple binary outputs.
4. Provide capability for future system expansion to include monitoring and use of occupant card access, lighting control and general equipment control.
5. System shall be capable of email generation for remote alarm annunciation.
6. Control system start-up shall be a required service to be completed by the manufacturer or a duly authorized, competent representative that has been factory trained in Mitsubishi controls system configuration and operation. The representative shall provide proof of certification for Mitsubishi CMCN Essentials Training and/or CMCN Hands-On Training indicating successful completion of no more than 2 years prior to system installation. This certification shall be included as part of the equipment and/or controls submittals. This service shall be equipment and system count dependent and shall be a minimum of one 8-hour period to be completed during normal working hours.
7. Mitsubishi universal thermostat interface kits (PAC-US444CN-1) shall be provided per each indoor fan coil unit to allow for 3<sup>rd</sup> party control via 5 or 7 wire 24V connections. A separate 24V 20VA transformer will be field-supplied per indoor fan coil unit to power the 3<sup>rd</sup> party controller.

## 2.07 SPLIT SYSTEM OUTDOOR HEAT PUMP UNIT (TURY)

A. General:

1. The Trane-Mitsubishi TURY outdoor unit modules shall be air-cooled, direct expansion (DX), multi-zone units shall be used specifically with CITY MULTI VRF components. The TURY outdoor units shall be equipped with a single compressor, which is inverter driven, multiple circuit boards that interface to the M-NET controls system and shall perform all functions necessary for operation. Each outdoor unit module shall be completely factory assembled, piped and wired and run tested at the factory.
2. All units requiring a factory supplied twinning kit shall be piped together in the field, without the need for equalizing line(s). If an alternate manufacturer is selected, any additional material, cost, and labor to install additional lines shall be incurred by the contractor.
  - a. Twinning kit required: CMY-R300NCBK

3. Outdoor unit shall have a sound rating no higher than 66.5 dB(A) individually or 69.5 dB(A) twinned. Units shall have a sound rating no higher than 52 dB(A) individually or 55 dB(A) twinned while in night mode operation. Units shall have 5 levels sound adjustment via dip switch selectable fan speed settings. If an alternate manufacturer is selected, any additional material, cost, and labor to meet published sound levels shall be incurred by the contractor.
  4. Both refrigerant lines from the TURY outdoor unit to the indoor units shall be insulated.
  5. The outdoor unit shall have the capability of installing the main refrigerant piping through the bottom of the unit.
  6. The outdoor unit shall have an accumulator with refrigerant level sensors and controls. Units shall actively control liquid level in the accumulator via Linear Expansion Valves (LEV) from the heat exchanger.
  7. The outdoor unit shall have a high-pressure safety switch, over-current protection, crankcase heater and DC bus protection.
  8. The outdoor unit shall be capable of operating in heating mode down to -18°F ambient temperatures or cooling mode down to 23°F ambient temperatures, without additional low ambient controls. If an alternate manufacturer is selected, any additional material, cost, and labor to meet low ambient operating condition and performance shall be incurred by the contractor.
  9. The outdoor units shall have a high efficiency oil separator plus additional logic controls to ensure adequate oil volume in the compressor is maintained. Oil return sequences must be enabled only during extended periods of reduced refrigerant flow to ensure no disruption to correct refrigerant flow to individual zones during peak loads. Systems which might engage oil return sequence based on hours of operation risk oil return during inopportune periods are not allowed. Systems which rely on sensors (which may fail) to engage oil return sequence are not allowed.
  10. Unit must defrost all circuits simultaneously in order to resume full heating more quickly during extreme low ambient temperatures (below 23°F). Partial defrost, also known as hot gas defrost which allows reduced heating output during defrost, is permissible only when ambient temperature is above 23°F.
  11. While in hot gas defrost the system shall slow the indoor unit fan speed down to maintain a high discharge air temperature, systems that keep fan running in same state shall not be allowed as they provide an uncomfortable draft to the indoor zone due to lower discharge air temperatures.
  12. In reverse defrost all refrigerant shall be bypassed in the main branch controller and shall not be sent out to the indoor units, systems that flow refrigerant through indoor units during reverse defrost shall not be allowed.
- B. Unit Cabinet:
1. The casing(s) shall be fabricated of galvanized steel, bonderized and finished.
- C. Fan:
1. Each outdoor unit module shall be furnished with direct drive, variable speed propeller type fan. The fan shall be factory set for operation under 0 in. WG external static pressure, but capable of normal operation under a maximum of 0.32 in. WG external static pressure via dipswitch.
  2. All fan motors shall have inherent protection, have permanently lubricated bearings, and be completely variable speed.
  3. All fan motors shall be mounted for quiet operation.
  4. All fans shall be provided with a raised guard to prevent contact with moving parts.
- D. Refrigerant and Refrigerant Piping
1. R410A refrigerant shall be required for the outdoor unit systems.



2. Polyolester (POE) oil shall be required. Prior to bidding, manufacturers using alternate oil types shall submit material safety data sheets (MSDS) and comparison of hygroscopic properties for alternate oil with list of local suppliers stocking alternate oil for approval at least two weeks prior to bidding.
  3. Refrigerant piping shall be phosphorus deoxidized copper (copper and copper alloy seamless pipes) of sufficient radial thickness as defined by the VRF equipment manufacturer and installed in accordance with manufacturer recommendations.
  4. All refrigerant piping must be insulated with ½" closed cell, CFC-free foam insulation with flame-Spread Index of less than 25 and a smoke-development Index of less than 50 as tested by ASTM E 84 and CAN / ULC S-102. R value of insulation must be at least 3.
  5. Refrigerant line sizing shall be in accordance with manufacturer specifications. Future changes to indoor unit styles or sizes must be possible without resizing/replacing refrigerant piping to any other branch devices or indoor units.
- E. Coil:
1. Outdoor Coil shall be constructed to provide equal airflow to all coil face surface are by means of a 4-sided coil
  2. Outdoor Coil shall be elevated at least 12" from the base on the unit to protect coil from freezing and snow build up in cold climates.
  3. The outdoor heat exchanger shall be of zinc coated aluminum construction with turbulating flat tube construction. The coil fins shall have a factory applied corrosion resistant finish. Uncoated aluminum coils/fins are not allowed.
  4. The coil shall be protected with an integral metal guard.
  5. Refrigerant flow from the outdoor unit shall be controlled by means of an inverter driven compressor.
  6. Unit shall have prewired plugs for optional panel heaters in order to prevent any residual ice buildup from defrost. Panel heaters are recommended for operating environments where the ambient temperature is expected to stay below -1F for 72 hours.
  7. Condenser coil shall have active hot gas circuit direct from compressor discharge on lowest coil face area to shed defrost condensate away from coil and protect from Ice formation after returning to standard heat pump operation. While in Heat Pump operation this lower section of the Outdoor Evaporator coil shall continually run hot gas from the compressor discharge to protect the coil from ice buildup and coil rupture. Manufacturers who do not have an active hot gas circuit in the lower section of the Outdoor coil to protect coil from freezing shall not be allowed to bid on project in markets where the outdoor unit will see temperatures below freezing
- F. Compressor:
1. Each outdoor unit module shall be equipped with one inverter driven scroll hermetic compressor. Non inverter-driven compressors, which cause inrush current (demand charges) and require larger wire sizing, shall not be allowed.
  2. Each compressor shall be equipped with a multi-port discharge mechanism to eliminate over compression at part load. Manufacturer's that rely on a single compressor discharge port and provide no means of eliminating over compression and energy waste at part load shall not be allowed.
  3. Crankcase heat shall be provided via induction-type heater utilizing eddy currents from motor windings. Energy-wasting "belly-band" type crankcase heaters are not allowed. Manufacturers that utilize belly-band crankcase heaters will be considered as alternate only.
  4. Compressor shall have an inverter to modulate capacity. The capacity for each compressor shall be variable with a minimum turndown not greater than 15%.
  5. The compressor shall be equipped with an internal thermal overload.
  6. Field-installed oil equalization lines between modules are not allowed.

G. Controls:

1. Outdoor unit shall include Variable Evaporator Temperature or comparable method of varying system evaporator (refrigerant) temperature in order to reduce compression ratio and power consumption during light load or mild ambient temperatures. Multiple evaporator refrigerant temperature settings shall be required in order to optimize efficiency within required system-specific performance and installation constraints. System shall reduce compression ratio only when/if all indoor units are within 1.8F of setpoint; reducing compression ratio based solely on ambient temperature risks discomfort and is not allowed. Variable Evaporator Temperature or comparable method shall incorporate override or disable capability based on external signal to allow for space humidity control or load demand.
2. The unit shall be an integral part of the system & control network and react to heating/cooling demand as communicated from connected indoor units over the control circuit. Required field-installed control voltage transformers and/or signal boosters shall be provided by the manufacturer.
3. Each outdoor unit module shall have the capability of 4 levels of demand control based on external input.

H. Electrical:

1. The outdoor unit electrical power shall be 208/230 volts, 3-phase, 60 hertz or 460 volts, 3-phase, 60 hertz per equipment schedule.
2. The outdoor unit shall be controlled by integral microprocessors.
3. The control circuit between the indoor units, BC Controller and the outdoor unit shall be 24VDC completed using a 2-conductor, twisted pair shielded cable to provide total integration of the system.

## 2.08 BRANCH CIRCUIT (BC) CONTROLLERS FOR SIMULTANEOUS HEAT/COOL SYSTEMS

A. General

1. The BC (Branch Circuit) Controllers shall include multiple branches to allow simultaneous heating and cooling by allowing either hot gas refrigerant to flow to indoor unit(s) for heating or subcooled liquid refrigerant to flow to indoor unit(s) for cooling. Refrigerant used for cooling must always be subcooled for optimal indoor unit LEV performance; alternate branch devices with no subcooling risk bubbles in liquid supplied to LEV and are not allowed.

- B. BC Controllers (or comparable branch devices) shall be equipped with a circuit board that interfaces to the controls system and shall perform all functions necessary for operation. The unit shall have a galvanized steel finish and be completely factory assembled, piped and wired. Each unit shall be run tested at the factory. This unit shall be mounted indoors, with access and service clearance provided for each controller. BC Controllers (or comparable branch devices) shall be suitable for use in plenums in accordance with UL1995 ed 4.

C. BC Unit Cabinet:

1. The casing shall be fabricated of galvanized steel.
2. Each cabinet shall house a liquid-gas separator and multiple refrigeration control valves.
3. The unit shall house two tube-in-tube heat exchangers.

D. Refrigerant Piping (specifications in addition to those for outdoor unit):

1. All refrigerant pipe connections shall be brazed.
2. Future changes to indoor unit quantities or sizes served by BC Controller or comparable branch device must be possible with no piping changes except between the branch device and indoor unit(s) changing. Systems which might require future piping changes between branch device and outdoor unit – if changes to indoor unit quantities or sizes

are made— are not considered equal and are not allowed.

- E. Refrigerant valves:
  - 1. Service shut-off valves shall be field-provided/installed for each branch to allow service to any indoor unit without field interruption to overall system operation.
- F. Future Use Branch:
  - 1. Each VRF system shall include at least one (1) unused branch or branch device for future use. Future-use branches or branch devices shall be fully installed & wired in central location with capped service shutoff valve & service port.
- G. Condensate Management:
  - 1. BC Controller (or comparable branch device) must have integral resin drain pan or insulate refrigeration components with removable insulation that allows easy access for future service needs. Cabinets filled with solid foam insulation do not allow for future service and are not allowed.
- H. Electrical:
  - 1. The unit electrical power shall be 208/230 volts, 1 phase, 60 Hertz. The unit shall be capable of satisfactory operation within voltage limits of 187-228 (208V/60Hz) or 207-253 (230/60Hz).
  - 2. The BC Controller shall be controlled by integral microprocessors.
  - 3. The control circuit between the indoor units and outdoor units shall be 24VDC completed using a 2-conductor, twisted pair shielded cable to provide total integration of the system.

#### **2.09 SPLIT SYSTEM INDOOR UNIT (4-WAY CEILING-RECESSED CASSETTE WITH GRILLE)**

- A. Mitsubishi PLFY series four-way cassette as scheduled on the Drawings or approved equal. The indoor unit shall recess into the ceiling with a ceiling grille. The indoor unit shall be factory assembled, wired and run tested. Contained within the unit shall be all factory wiring, piping, electronic modulating linear expansion device, control circuit board and fan motor. The unit shall have a self-diagnostic function, 3-minute time delay mechanism, an auto restart function, an emergency operation function, a test run switch and the ability to adjust airflow patterns for different ceiling heights. Indoor unit and refrigerant pipes shall be charged with dehydrated air before shipment from the factory.
- B. Unit Cabinet:
  - 1. The cabinet panel shall have provisions for a field installed filtered outside air intake.
  - 2. Branch ducting shall be allowed from cabinet.
  - 3. Four-way grille shall be fixed to bottom of cabinet allowing two, three or four-way blow.
  - 4. The grille vane angles shall be individually adjustable from a wired remote controller to customize the airflow pattern for the conditioned space
- C. Fan:
  - 1. The indoor fan shall be an assembly with a statically and dynamically balanced turbo fan direct driven by a single motor with permanently lubricated bearings.
  - 2. The indoor unit shall include an AUTO fan setting capable of maximizing energy efficiency by adjusting the fan speed based on the difference between controller set-point and space temperature. The indoor fan shall be capable of five (5) speed settings, Low, Mid1, Mid2, High and Auto.
  - 3. The indoor unit shall have an adjustable air outlet system offering 4-way airflow, 3-way airflow, or 2-way airflow.
  - 4. The indoor unit fan logic must include multiple setting that can be changed to provide optimum airflow based on ceiling height and number of outlets used.

5. The indoor unit vanes shall have 5 fixed positions and a swing feature that shall be capable of automatically swinging the vanes up and down for uniform air distribution.
  6. The vanes shall have an Auto-Wave selectable option in the heating mode that shall randomly cycle the vanes up and down to evenly heat the space.
- D. Filter:
1. Return air shall be filtered by means of a long-life washable filter.
- E. Coil:
1. The indoor coil shall be of nonferrous construction with smooth plate fins on copper tubing.
  2. The tubing shall have inner grooves for high efficiency heat exchange.
  3. All tube joints shall be brazed with phos-copper or silver alloy.
  4. The coils shall be pressure tested at the factory.
  5. The unit shall be provided with an integral condensate lift mechanism that will be able to raise drain water 33" inches above the condensate pan.
- F. Controls:
1. Indoor unit shall compensate for the higher temperature sensed by the return air sensor compared to the temperature at level of the occupant when in HEAT mode. Disabling of compensation shall be possible for individual units to accommodate instances when compensation is not required.
  2. Control board shall include contacts for control of external heat source. External heat may be energized as second stage with 1.8°F - 9.0°F adjustable deadband from set point.
  3. Indoor unit shall include no less than four (4) digital inputs capable of being used for customizable control strategies.
  4. Indoor unit shall include no less than three (3) digital outputs capable of being used for customizable control strategies.
  5. A factory-installed drain pan sensor shall provide protection against drain pan overflow by sensing a high condensate level in the drain pan. Should this occur the control shuts down the indoor unit before an overflow can occur. A thermistor error code will be produced should the sensor activate indicating a fault which must be resolved before the unit re-starts

#### **2.10 SPLIT SYSTEM INDOOR UNIT (4-WAY CEILING-RECESSED CASSETTE WITH GRILLE FOR 2X2 GRID)**

- A. Mitsubishi PLFY series four-way cassette as scheduled on the Drawings or approved equal. The indoor unit shall recess into the ceiling with a ceiling grille. The indoor unit shall be factory assembled, wired and run tested. Contained within the unit shall be all factory wiring, piping, electronic modulating linear expansion device, control circuit board and fan motor. The unit shall have a self-diagnostic function, 3-minute time delay mechanism, an auto restart function, an emergency operation function and a test run switch. Indoor unit and refrigerant pipes shall be charged with dehydrated air before shipment from the factory.
- B. Unit Cabinet:
1. The cabinet shall be a compact 22-7/16" wide x 22-7/16" deep so it will fit within a standard 24" square suspended ceiling grid.
  2. The cabinet panel shall have provisions for a field installed filtered outside air intake.
  3. Four-way grille shall be fixed to bottom of cabinet allowing two, three or four-way blow.
- C. Fan:
1. The indoor fan shall be an assembly with a turbo fan direct driven by a single motor.
  2. The indoor fan shall be statically and dynamically balanced to run on a motor with permanently lubricated bearings.

3. The indoor fan shall consist of three (3) speeds, Low, Mid, and High.
  4. The indoor unit shall have an adjustable air outlet system offering 4-way airflow, 3-way airflow, or 2-way airflow.
  5. The auto air swing vanes shall be capable of automatically swinging up and down for uniform air distribution.
- D. Filter:
1. Return air shall be filtered by means of a long-life washable filter.
- E. Coil:
1. The indoor coil shall be of nonferrous construction with smooth plate fins on copper tubing.
  2. The tubing shall have inner grooves for high efficiency heat exchange.
  3. All tube joints shall be brazed with phos-copper or silver alloy.
  4. The coils shall be pressure tested at the factory.
  5. A condensate pan and drain shall be provided under the coil.
  6. The unit shall be provided with an integral condensate lift mechanism that will be able to raise drain water 19-3/4" inches above the condensate pan.
  7. Both refrigerant lines to the PLFY indoor units shall be insulated.

## **2.11 SPLIT SYSTEM INDOOR UNIT (MEDIUM STATIC CEILING-CONCEALED DUCTED)**

- A. Mitsubishi "PEFY-NMAU" series as scheduled on the Drawings or approved equal. The ceiling-concealed ducted indoor unit shall be factory assembled, wired and run tested. Contained within the unit shall be all factory wiring, piping, electronic modulating linear expansion device, control circuit board and fan motor. The unit shall have a self-diagnostic function, 3-minute time delay mechanism, and an auto restart function. Indoor unit and refrigerant pipes shall be charged with dehydrated air before shipment from the factory. The unit shall be suitable for use in plenums in accordance with UL1995 ed 4.
- B. Unit Cabinet:
1. The unit shall be, ceiling-concealed, ducted with a 2-position, field adjustable return and a horizontal discharge supply.
  2. The cabinet panel shall have provisions for a field installed filtered outside air intake.
- C. Fan:
1. PEFY-NMAU models shall feature external static pressure settings from 0.14 to 0.60 in. WG.
  2. The indoor unit fan shall be an assembly with one or two Sirocco fan(s) direct driven by a single motor.
  3. The indoor fan shall be statically and dynamically balanced and run on a motor with permanently lubricated bearings.
  4. The indoor fan shall consist of three (3) speeds, High, Mid, and Low plus the Auto-Fan function
  5. The indoor unit shall have a ducted air outlet system and ducted return air system.
- D. Filter:
1. Return air shall be filtered by means of a standard factory installed return air filter.
- E. Coil:
1. The indoor coil shall be of nonferrous construction with smooth plate fins on copper tubing.
  2. The tubing shall have inner grooves for high efficiency heat exchange.
  3. All tube joints shall be brazed with phos-copper or silver alloy.
  4. The coils shall be pressure tested at the factory.

5. A condensate pan and drain shall be provided under the coil.
6. The condensate shall be gravity drained from the fan coil.
7. Both refrigerant lines to the PEFY indoor units shall be insulated.

## **2.12 SPLIT SYSTEM INDOOR UNIT (HIGH STATIC CEILING-CONCEALED DUCTED)**

- A. Mitsubishi "PEFY-NMHU" series as scheduled on the Drawings or approved equal. The ceiling-concealed ducted indoor unit shall be factory assembled, wired and run tested. Contained within the unit shall be all factory wiring, piping, electronic modulating linear expansion device, control circuit board and fan motor. The unit shall have a self-diagnostic function, 3-minute time delay mechanism, and an auto restart function. Indoor unit and refrigerant pipes shall be charged with dehydrated air before shipment from the factory. The unit shall be suitable for use in plenums in accordance with UL1995 ed 4.
- B. Unit Cabinet:
  1. The unit shall be, ceiling-concealed, ducted with a fixed rear return and a horizontal discharge supply.
  2. The cabinet panel shall have provisions for a field installed filtered outside air intake.
- C. Fan:
  1. Adjustable external static pressure settings shall be up to 1.00 in. WG.
  2. The indoor unit fan shall be an assembly with one or two statically and dynamically balanced Sirocco fan(s) direct driven by a single motor with permanently lubricated bearings.
- D. Filter Frame and Filter:
  1. Return filter box (rear or bottom placement) with high-efficiency filter shall be provided as noted on equipment schedule. All filter boxes include 2" thick pleated MERV 13 filter(s) installed.
  2. Filter frame shall be constructed of 20 gauge G-60 galvanized steel. Knurled thumb screws on access door allow filter replacement. Foam gasket provides air-tight connection to indoor unit and access door. Filter frame shall be configurable for rear or bottom return.
  3. Filter shall be rated MERV 13 when tested in accordance with ANSI/ASHRAE 52.2 Standard Rated Class 2 under U.L. Standard 900
- E. Coil:
  1. The indoor coil shall be of nonferrous construction with smooth plate fins on copper tubing. The tubing shall have inner grooves for high efficiency heat exchange. All tube joints shall be brazed with phos-copper or silver alloy.
  2. The coils shall be pressure tested at the factory.
  3. Coil shall be provided with a sloped drain pan. Units without sloped drain pans which must be installed cockeyed to ensure proper drainage are not allowed.
  4. The unit shall be provided with an integral condensate lift mechanism able to raise drain water 27 inches above the condensate pan.
- F. Controls:
  1. Indoor unit shall compensate for the higher temperature sensed by the return air sensor compared to the temperature at level of the occupant when in HEAT mode. Disabling of compensation shall be possible for individual units to accommodate instances when compensation is not required.
  2. Control board shall include contacts for control of external heat source. External heat may be energized as second stage with 1.8°F - 9.0°F adjustable deadband from set point.
  3. Indoor unit shall include no less than 4 digital inputs capable of being used for customizable control strategies.

4. Indoor unit shall include no less than 3 digital outputs capable of being used for customizable control strategies.

### 2.13 SPLIT SYSTEM AIR CONDITIONER OUTDOOR UNIT

- A. Mitsubishi Electric model PUY-A12NHA4 air conditioner system as scheduled on the Drawings or approved equal. The air conditioner shall be a split system with variable speed inverter compressor technology. The system shall consist of a horizontal discharge, single phase outdoor unit and a matched capacity indoor section. A dry air holding charge shall be provided in the indoor section. The outdoor unit shall be pre-charged with R-410a refrigerant for 70 feet (20 meters) of refrigerant tubing.
- B. The outdoor unit shall be equipped with an electronic control board that interfaces with the indoor unit to perform all necessary operation functions. The outdoor unit shall be completely factory assembled, piped, and wired. Each unit must be test run at the factory.
- C. The sound level shall not exceed 46 dB(A).
- D. Cabinet
  1. The casing shall be constructed from galvanized steel plate, finished with an electrostatically applied, thermally fused acrylic or polyester powder coating for corrosion protection and have a Munsell 3Y 7.8/1.1 finish.
  2. Mounting feet shall be provided and shall be welded to the base of the cabinet and be of sufficient size to afford reliable equipment mount and stability.
  3. Easy access shall be afforded to all serviceable parts by means of removable panel sections.
  4. The fan grill shall be of ABS plastic.
- E. Fan
  1. The unit shall be furnished with a single DC fan motor.
  2. The fan blade(s) shall be of aerodynamic design and the fan motor bearings shall be permanently lubricated.
  3. The outdoor unit shall have horizontal discharge airflow. The fan shall be mounted in front of the coil, pulling air across it from the rear and dispelling it through the front. The fan shall be provided with a raised guard to prevent external contact with moving parts.
- F. Coil
  1. The L shaped condenser coil shall be of copper tubing with flat aluminum fins to reduce debris build up and allow maximum airflow. The coil shall be protected with an integral metal guard.
  2. Refrigerant flow from the condenser shall be controlled by means of an electronic linear expansion valve (LEV) metering device. The LEV shall be controlled by a microprocessor controlled step motor.
  3. All refrigerant lines between outdoor and indoor units shall be of annealed, refrigeration grade copper tubing, ARC Type, meeting ASTM B280 requirements, individually insulated in twin-tube, flexible, closed-cell, CFC-free (ozone depletion potential of zero), elastomeric material for the insulation of refrigerant pipes and tubes with thermal conductivity equal to or better than 0.27 BTU-inch/hour per Sq Ft / °F, a water vapor transmission equal to or better than 0.08 Perm-inch and superior fire ratings such that insulation will not contribute significantly to fire and up to 1" thick insulation shall have a - Flame-Spread Index of less than 25 and a Smoke-development Index of less than 50 as tested by ASTM E 84 and CAN / ULC S-102.
- G. Compressor

1. The compressor for shall be a DC twin-rotor rotary compressor with Variable Speed Inverter Drive Technology.
  2. The compressor shall be driven by inverter circuit to control compressor speed. The compressor speed shall dynamically vary to match the room load for significantly increasing the efficiency of the system which shall result in significant energy savings.
  3. To prevent liquid from accumulating in the compressor during the off cycle, a minimal amount of current shall be automatically, intermittently applied to the compressor motor windings to maintain sufficient heat to vaporize any refrigerant. No crankcase heater is to be used.
  4. The outdoor unit shall have an accumulator and high-pressure safety switch. The compressor shall be mounted to avoid the transmission of vibration.
- H. Electrical
1. The electrical power of the unit shall be 208 volts, single phase, 60 hertz. The unit shall be capable of satisfactory operation within voltage limits of 187 volts to 253 volts.
  2. Power for the indoor unit shall be supplied from the outdoor unit via Mitsubishi Electric A-Control using three (3) fourteen (14) gauge AWG conductors plus ground wire connecting the units.
  3. The outdoor unit shall be controlled by the microprocessor located in the indoor unit.
  4. The control signal between the indoor unit and the outdoor unit shall be pulse signal 24 volts DC.
  5. The unit shall have Pulse Amplitude Modulation circuit to utilize 98% of input power supply.

#### **2.14 SPLIT SYSTEM INDOOR UNIT (WALL MOUNTED TYPE)**

- A. Mitsubishi Electric "PKA" series, wall mounted indoor unit, as scheduled on the Drawings or approved equal.
- B. The indoor unit shall be factory assembled, wired and tested. Contained within the unit shall be all factory wiring and internal piping, control circuit board and fan motor. The unit, in conjunction with the wired wall-mounted controller, wireless wall-mounted controller or wireless handheld controller, shall have a self-diagnostic function, 3-minute time delay mechanism, an auto restart function, and a test run switch. Indoor unit and refrigerant pipes shall be purged with dry nitrogen before shipment from the factory.
- C. Unit Cabinet: The cabinet shall be formed from high strength molded plastic with smooth finish, flat front panel design with access for filter. Cabinet color shall be white - Munsell 1.0Y 9.2/0.2. The unit shall be wall mounted by means of a factory supplied, pre-drilled, mounting plate.
- D. Fan: The indoor unit fan shall be high performance, double inlet, forward curve, direct drive sirocco fan with a single motor. The fans shall be statically and dynamically balanced and run on a motor with permanently lubricated bearings. The indoor fan shall consist of three (3) speeds: Low, Mid, and Hi and Auto. The fan shall have a selectable Auto fan setting that will adjust the fan speed based on the difference between controller set-point and space temperature. Sound levels shall not exceed 36 dB(A) at low speed, 40 dB(A) at mid speed and 43 dB(A) at high speed.
- E. Vane: There shall be a motorized horizontal vane to automatically direct air flow in a horizontal and downward direction for uniform air distribution. The horizontal vane shall significantly decrease downward air resistance for lower sound levels and shall close the outlet port when operation is stopped. There shall also be a set of vertical vanes to provide horizontal swing airflow movement.



- F. Filter: Return air shall be filtered by means of an easily removable washable filter.
- G. Coil: The evaporator coil shall be of nonferrous construction with pre-coated aluminum strake fins on copper tubing. The multi-angled heat exchanger shall have a modified fin shape that reduces air resistance for a smoother, quieter airflow. All tube joints shall be brazed with PhosCopper or silver alloy. The coils shall be pressure tested at the factory. A condensate pan and drain shall be provided under the coil. An optional drain pan level switch (DPLS1), designed to connect to the control board, shall be provided if required, and installed on the condensate pan to prevent condensate from overflowing.
- H. Electrical: The electrical power of the unit shall be 208 volts, 1 phase, 60 hertz. The system shall be capable of satisfactory operation within voltage limits of 187 volts to 253 volts. The power to the indoor unit shall be supplied from the outdoor unit, using the Mitsubishi Electric A-Control system. For A-Control, a three (3) conductor AWG-14 wire with ground shall provide power feed and bi-directional control transmission between the outdoor and indoor units.
- I. System Control: The control system shall consist of a minimum of two (2) microprocessors, one on each indoor and outdoor unit, interconnected by a single non-polar two-wire cable. The microprocessor located in the indoor unit shall have the capability of monitoring return air temperature and indoor coil temperature, receiving and processing commands from a wireless or wired controller, providing emergency operation and controlling the outdoor unit. The control signal between the indoor and outdoor unit shall be pulse signal 24 volts DC. Indoor units shall have the ability to control supplemental heat via connector CN152 and a 12 VDC output.

## 2.15 THERMOSTAT

- A. Mitsubishi universal thermostat interface kit (PAC-US444CN-1) shall be provided per each indoor fan coil unit to allow for 3rd party control via 5 or 7 wire 24V connections. A separate 24V 20VA transformer shall be field supplied, per indoor fan coil unit, to power the 3rd party thermostat controller.

## 2.16 ENERGY RECOVERY VENTILATOR

- A. Mitsubishi "PremiSys" series, model TUMPE-1-W1-52-060-1, as scheduled on the Drawings or approved equal.
- B. The dedicated outdoor air system shall be UL\cUL 1995 listed. The exterior housing shall be constructed of galvanized steel and painted with "Permatector Silk Grey" (RAL 7044). The units shall be internally lined with galvanized steel metal, creating a double wall and shall be insulated with 2 inch 2.4# R13 density foam insulation.
- C. The units shall have an energy recovery cassette with a desiccant wheel, direct-drive airfoil plenum blowers with factory-mounted VFDs, ball-bearing motors and corrosion resistant fasteners.
- D. The units shall be equipped with internally mounted control center with motor starters, 24 VAC control transformers, control circuit fusing, and an exhaust discharge gravity backdraft damper.
- E. The air-source heat pump shall have hermetic scroll type compressors mounted in an isolated compartment to be serviceable without affecting airflow, on neoprene vibration isolators. The equipment shall include an electronic expansion valve, an ECM outdoor fan for modulating head pressure control, liquid line filter drier, high-pressure manual reset control and low-pressure auto reset cutout, time delay relays for compressor protection, service/charging

valves, and moisture-indicating sight glass. The outdoor fan(s) shall be direct-drive type, statically and dynamically balanced.

- F. Secondary heating equipment shall contain open coil heating elements, high grade Nickel-Chrome alloy coils, corrosion resistant frame, and ceramic coil support bushings. The electric heater shall be CSA and NRTL/C approved.
- G. Accessories shall include:
  - 1. Downturned weatherhood
  - 2. MERV 13 filters
  - 3. Outdoor air dampers, motorized low leakage
  - 4. Painted exterior: Permatector Silk Grey (RAL 7044)
  - 5. Microprocessor controls
  - 6. Supply fan VFD Control - constant volume (on/off)
  - 7. Exhaust fan VFD control - constant volume
  - 8. Phase and brown out protection
  - 9. A factory-mounted unit disconnect
  - 10. Web-based user interface.
  - 11. Phase and brown out protection for the controls

## 2.17 PACKAGED ROOFTOP AIR CONDITIONING

- A. Carrier 48TC series air conditioning units, as scheduled on the Drawings or approved equal. The air conditioning units shall be outdoor, rooftop mounted, electrically controlled heating and cooling units, utilizing a fully hermetic scroll compressor(s) for cooling duty and gas combustion for heating duty. Contained within the unit enclosure shall be all factory wiring, piping, controls, and special features required prior to field start-up. Units shall use R-410a "Puron" refrigerant.
- B. Operating Characteristics
  - 1. Unit shall be capable of starting and running at 115°F ambient outdoor temperature, meeting maximum load criteria of AHRI Standard 210/240 or 340/360 at 10% voltage.
  - 2. Compressor with standard controls shall be capable of operation down to 40°F ambient outdoor temperatures. Accessory winter start kit is necessary if mechanically cooling at ambient temperature down to 25°F.
  - 3. Units shall discharge supply air vertically or horizontally as shown on contract drawings.
  - 4. Units shall be factory configured for vertical supply & return configurations.
  - 5. Units shall be field convertible from vertical to horizontal airflow on all models.
  - 6. Unit shall be capable of mixed operation: vertical supply with horizontal return or horizontal supply with vertical return.
- C. Electric and Electronic Control System for HVAC
  - 1. Shall be complete with self-contained low-voltage control circuit protected by a resettable circuit breaker on the 24-v transformer side. Transformer shall have 75VA capability.
  - 2. Shall utilize color-coded wiring.
  - 3. Shall include a central control terminal board to conveniently and safely provide connection points for vital control functions such as: smoke detectors, phase monitor, gas controller, economizer, thermostat, DDC control options, and low and high-pressure switches.
  - 4. The heat exchanger shall be controlled by an integrated gas controller (IGC) microprocessor.
  - 5. Unit shall include a minimum of one 8-pin screw terminal connection board for connection of control wiring.
  - 6. Safeties:

- a. Compressor over-temperature, over-current. High internal pressure differential.
  - b. Low-pressure switch.
    - 1) Units with 2 compressors shall have different sized connectors for the circuit 1 and circuit 2 low and high-pressure switches. They shall physically prevent the cross-wiring of the safety switches between circuits 1 and 2.
    - 2) Low pressure switch shall use different color wire than the high-pressure switch.
  - c. High-pressure switch.
    - 1) Units with 2 compressors shall have different sized connectors for the circuit 1 and circuit 2 low and high-pressure switches. They shall physically prevent the cross-wiring of the safety switches between circuits 1 and 2.
    - 2) High-pressure switch shall use different color wire than the low-pressure switch.
  - d. Automatic reset, motor thermal overload protector.
  - e. Heating section shall be provided with the following minimum protections:
    - 1) High-temperature limit switches.
    - 2) Induced draft motor speed sensor.
    - 3) Flame rollout switch.
    - 4) Flame proving controls.
- D. Thermostats
1. Thermostat must
    - a. energize both "W" and "G" when calling for heat.
    - b. have capability to energize 2 different stages of cooling, and 2 different stages of heating.
    - c. include capability for occupancy scheduling.
- E. Unit Cabinet
1. Unit cabinet shall be constructed of galvanized steel and shall be bonderized and coated with a pre-painted baked enamel finish on all externally exposed surfaces.
  2. Unit cabinet exterior paint shall be: film thickness, (dry) 0.003 inches minimum, gloss (per ASTM D523, 60°F): 60, Hardness: H-2H Pencil hardness.
  3. Evaporator fan compartment interior cabinet insulation shall conform to AHRI Standards 210/240 or 340/360 minimum exterior sweat criteria. Interior surfaces shall be insulated with a minimum ½-inch thick, 1½ pound density, flexible fiberglass insulation, neoprene coated on the air side. Aluminum foil-faced fiberglass insulation shall be used in the gas heat compartment.
  4. Unit internal insulation linings shall be resistant to mold growth in accordance with "mold growth and humidity" test in ASTM C1338, G21, and UL 181 or comparable test method. Air stream surfaces shall be evaluated in accordance with the "Erosion Test" in UL 181, as part of ASTM C1071. (48HC)
  5. Base of unit shall have a minimum of 4 locations for thru-the-base gas and electrical connections (factory installed or field installed) standard.
- F. Base Rail
1. Unit shall have base rails on a minimum of 4 sides.
  2. Holes shall be provided in the base rails for rigging shackles to facilitate maneuvering and overhead rigging.
  3. Holes shall be provided in the base rail for moving the rooftop by fork truck.
  4. Base rail shall be a minimum of 16-gauge thickness.
- G. Condensate pan and connections:
1. Shall be an internally sloped condensate drain pan made of a non-corrosive material.
  2. Shall comply with ASHRAE Standard 62.

3. Shall use a 3/4-inch -14 NPT drain connection, possible either through the bottom or side of the drain pan. Connection shall be made per manufacturer's recommendations.
  4. Top panel shall be a single piece.
- H. Standard Filter Section
1. Shall consist of factory-installed, low velocity, disposable 2" thick fiberglass filters.
  2. Unit shall use only one filter size. Multiple sizes are not acceptable.
  3. Filters shall be accessible through an access panel with "no-tool" removal.
  4. Filters shall be held in place by a pivoting filter tray.
  5. Shall consist of factory-installed, low velocity, throw-away 2-in. thick fiberglass filters.
  6. Filters shall be standard, commercially available sizes.
- I. Gas Connections:
1. All gas piping connecting to unit gas valve shall enter the unit cabinet at a single location on side of unit (horizontal plane).
  2. Thru-the-base capability
    - a. Units shall have factory installed thru-the-base gas-line location using a raised, embossed portion of the unit basepan.
    - b. No basepan penetration, other than those authorized by the manufacturer, is permitted.
- J. Electrical Connections:
1. All unit power wiring shall enter unit cabinet at a single, factory-prepared, knockout location.
  2. Thru-the-base capability
    - a. Units shall have thru-the-base electrical location(s) using a raised, embossed portion of the unit basepan.
    - b. No basepan penetration, other than those authorized by the manufacturer, is permitted
- K. Component access panels (standard)
1. Cabinet panels shall be easily removable for servicing.
  2. Unit shall have one factory installed, tool-less, removable, filter access panel.
  3. Panels covering control box, indoor fan, indoor fan motor, gas components (where applicable), and compressors shall have molded composite handles.
  4. Handles shall be UV modified, composite. They shall be permanently attached and recessed into the panel.
  5. Screws on the vertical portion of all removable access panel shall engage into heat resistant, molded composite collars.
  6. Collars shall be removable and easily replaceable using manufacturer recommended parts.
- L. Gas Heat
1. Heat exchanger shall be an induced draft design. Positive pressure heat exchanger designs shall not be allowed.
  2. Shall incorporate a direct--spark ignition system and redundant main gas valve.
  3. Gas supply pressure at the inlet to the rooftop unit gas valve must match that required by the manufacturer.
  4. Gas heat compartment insulation
    - a. Aluminum foil-faced fiberglass insulation shall be used.
    - b. Insulation and adhesive shall meet NFPA 90A requirements for flame spread and smoke generation.
  5. The heat exchanger shall be controlled by an integrated gas controller (IGC) microprocessor.

- a. IGC board shall notify users of fault using an LED (light-emitting diode).
  - b. The LED shall be visible without removing the control box access panel.
  - c. IGC board shall contain algorithms that modify evaporator-fan operation to prevent future cycling on high temperature limit switch.
  - d. Unit shall be equipped with anti-cycle protection with one short cycle on unit flame rollout switch or 4 continuous short cycles on the high temperature limit switch. Fault indication shall be made using an LED.
- M. Induced Draft Combustion Motor and Blower
1. Shall be a direct- drive, single inlet, forward- curved centrifugal type.
  2. Shall be made from steel with a corrosion- resistant finish.
  3. Shall have permanently lubricated sealed bearings.
  4. Shall have inherent thermal overload protection.
  5. Shall have an automatic reset feature.
- N. Coils
1. Standard Aluminum Fin/Copper Tube Coils:
    - a. Standard evaporator and condenser coils shall have aluminum lanced plate fins mechanically bonded to seamless internally grooved copper tubes with all joints brazed.
    - b. Evaporator coils shall be leak tested to 150 psig, pressure tested to 450 psig, and qualified to UL 1995 burst test at 1775 psig.
    - c. Condenser coils shall be leak tested to 150 psig, pressure tested to 650 psig, and qualified to UL 1995 burst test at 1980 psig.
- O. Refrigerant Components
1. Refrigerant circuit shall include the following control, safety, and maintenance features:
    - a. Thermostatic Expansion Valve (TXV) shall help provide optimum performance across the entire operating range. Shall contain removable power element to allow change out of power element and bulb without removing the valve body. (48HC)
    - b. Fixed orifice metering system shall prevent mal-distribution of two-phase refrigerant by including multiple fixed orifice devices in each refrigeration circuit. Each orifice is to be optimized to the coil circuit it serves. (48TC)
    - c. Refrigerant filter drier - solid core design.
    - d. Service gauge connections on suction and discharge lines.
    - e. Pressure gauge access through a specially designed access port in the top panel of the unit.
- P. There shall be gauge line access port in the skin of the rooftop, covered by a black, removable plug.
1. The plug shall be easy to remove and replace.
  2. When the plug is removed, the gauge access port shall enable maintenance personnel to route their pressure gauge lines.
  3. This gauge access port shall facilitate correct and accurate condenser pressure readings by enabling the reading with the compressor access panel on.
  4. The plug shall be made of a leak proof, UV--resistant, composite material.
- Q. Compressors
1. Unit shall use fully hermetic, scroll compressor for each independent refrigeration circuit.
  2. Compressor motors shall be cooled by refrigerant gas passing through motor windings.
  3. Compressors shall be internally protected from high discharge temperature conditions.
  4. Compressors shall be protected from an over-temperature and over-amperage conditions by an internal, motor overload device.
  5. Compressor shall be factory mounted on rubber grommets.

6. Compressor motors shall have internal line break thermal, current overload and high-pressure differential protection.
  7. Crankcase heaters shall not be required for normal operating range, unless provided by the factory.
- R. Evaporator Fan and Motor
1. Evaporator fan motor
    - a. Shall have permanently lubricated bearings.
    - b. Shall have inherent automatic-reset thermal overload protection or circuit breaker.
    - c. Shall have a maximum continuous bhp rating for continuous duty operation; no safety factors above that rating shall be required.
  2. Electric Drive (Direct Drive) X13 - 5 Speed/Torque Evaporator Fan: (48HC)
    - a. Multi-speed motor with easy quick adjustment settings.
    - b. Blower fan shall be double-inlet type with forward-curved blades.
    - c. Shall be constructed from steel with a corrosion resistant finish and dynamically balanced.
    - d. Standard on all 04-06 ton 3-phase models without Humidi-MiZer, with optional belt drive.
  3. Belt-driven Evaporator Fan:
    - a. Belt drive shall include an adjustable-pitch motor pulley.
    - b. Shall use sealed, permanently lubricated ball-bearing type.
    - c. Blower fan shall be double-inlet type with forward-curved blades.
    - d. Shall be constructed from steel with a corrosion resistant finish and dynamically balanced.
    - e. Provide belt-driven fan on all units, including 04 size.
- S. Condenser Fans and Motors
1. Condenser fan motors:
    - a. Shall be a totally enclosed motor.
    - b. Shall use permanently lubricated bearings.
    - c. Shall have inherent thermal overload protection with an automatic reset feature.
    - d. Shall use a shaft-down design on 04 to 12 models.
  2. Condenser Fans:
    - a. Shall be a direct-driven propeller type fan.
    - b. Shall have aluminum blades riveted to corrosion-resistant steel spiders.
    - c. Shall be dynamically balanced.
- T. Options, Accessories
1. EconoMi\$er X Ultra Low Leak rate models.
    - a. Integrated, gear driven opposing modulating blade design type capable of simultaneous economizer and compressor operation.
    - b. Independent modules for vertical or horizontal return configuration shall be available. Vertical return modules shall be available as a factory-installed option.
    - c. Damper blades shall be galvanized steel with composite gears. Plastic or composite blades on intake or return shall not be acceptable.
    - d. Shall include all hardware and controls to provide free cooling with outdoor air when temperature and/or humidity are below setpoints.
    - e. Shall be equipped with gear driven dampers for both the outdoor ventilation air and the return air for positive air stream control.
    - f. Ultra Low Leak design meets California Title 24 section 140.4 and ASHRAE 90.1-2013 requirements of 4 cfm per sq. ft. on the outside air dampers and 10 cfm per sq. ft. on the return dampers.
    - g. Economizer controller on EconoMi\$er X models shall be the Honeywell W7220 that

- provides:
- 1) 2-line LCD interface screen for setup, configuration and troubleshooting
  - 2) On-board Fault Detection and Diagnostics (FDD) that senses and alerts when the economizer is not operating properly, per California Title 24.
  - 3) Sensor failure loss of communication identification
  - 4) Automatic sensor detection
  - 5) Capabilities for use with multiple-speed indoor fan systems
  - 6) Utilize digital sensors: Dry bulb and Enthalpy
- h. Shall be capable of introducing up to 100% outdoor air.
  - i. Shall be equipped with a barometric relief damper capable of relieving up to 100% return air and contain seals that meet ASHRAE 90.1- 2013 requirements.
  - j. Shall be designed to close damper(s) during loss- of- power situations with spring return built into motor.
  - k. Dry bulb outdoor air temperature sensor shall be provided as standard. Enthalpy sensor is also available on factory- installed only. Outdoor air sensor setpoint shall be adjustable and shall range from 40 to 100° F (4 to 38° C). Additional sensor options shall be available as accessories.
  - l. The economizer controller shall also provide control of an accessory power exhaust unit function. Factory set at 100%, with a range of 0% to 100%.
  - m. The economizer shall maintain minimum airflow into the building during occupied period and provide design ventilation rate for full occupancy.
  - n. Dampers shall be completely closed when the unit is in the unoccupied mode.
  - o. Economizer controller shall accept a 2- 10 Vdc CO2 sensor input for IAQ/DCV control. In this mode, dampers shall modulate the outdoor air damper to provide ventilation based on the sensor input.
  - p. Compressor lockout temperature on W7220 is adjustable from - 45°F to 80°F, set at a factory default of 32°F. Others shall open at 35°F and closes at 50°F.
  - q. Actuator shall be direct coupled to economizer gear. No linkage arms or control rods shall be acceptable.
  - r. Economizer controller shall provide indications when in free cooling mode, in the DCV mode, or the exhaust fan contact is closed.
2. Variable Frequency Drive (VFD). Only available on 2-speed indoor fan motor option (SAV):
    - a. Factory supplied VFDs qualify, through ABB for a 24-month warranty from date of commissioning or 30 months from date of sale, whichever occurs first.
    - b. Shall be installed inside the unit cabinet, mounted, wired and tested.
    - c. Shall contain Electromagnetic Interference (EMI) frequency protection.
    - d. Insulated Gate Bi-Polar Transistors (IGBT) used to produce the output pulse width modulated (PWM) waveform, allowing for quiet motor operation.
    - e. Self-diagnostics with fault and power code LED indicator.
    - f. RS485 capability standard.
    - g. Electronic thermal overload protection.
    - h. 5% swinging chokes for harmonic reduction and improved power factor.
    - i. All printed circuit boards shall be conformal coated.
  3. Unit-Mounted, Non-Fused Disconnect Switch:
    - a. Switch shall be factory-installed, internally mounted.
    - b. National Electric Code (NEC) and UL or ETL approved non-fused switch shall provide unit power shutoff.
    - c. Shall be accessible from outside the unit.
    - d. Shall provide local shutdown and lockout capability.
    - e. Sized only for the unit as ordered from the factory. Does not accommodate field-installed devices.

4. Convenience Outlet:
  - a. Powered convenience outlet (3-phase models only).
    - 1) Outlet shall be powered from main line power to the rooftop unit.
    - 2) Outlet shall be powered from line side or load side of disconnect by installing contractor, as required by code. If outlet is powered from load side of disconnect, unit electrical ratings shall be UL or ETL certified and rated for additional outlet amperage.
    - 3) Outlet shall be factory-installed and internally mounted with easily accessible 115 v female receptacle.
    - 4) Outlet shall include 15-amp GFI receptacles with independent fuse protection.
    - 5) Voltage required to operate convenience outlet shall be provided by a factory- installed step-down transformer.
    - 6) Outlet shall be accessible from outside the unit.
    - 7) Outlet shall include a field-installed "Wet in Use" cover.
5. Hinged Access Panels
  - a. Shall provide easy access through integrated quarter turn latches.
  - b. Shall be on major panels of - filter, control box, fan motor and compressor
6. Condenser Coil Hail Guard Assembly
  - a. Shall protect against damage from hail.
  - b. Shall be either hood style or louvered.

## 2.18 PACKAGED ROOFTOP AIR CONDITIONING UNITS

- A. Carrier 48FC series, gas heat/electric cooling packaged rooftop units, as scheduled on the Drawings or approved equal. The units shall be factory assembled, single-piece heating and cooling rooftop type and shall utilize a fully hermetic scroll compressor(s) for cooling duty and gas combustion for heating duty. Contained within the unit enclosure shall be all factory wiring, piping, controls, and special features required prior to field start-up. Unit shall use "Puron" (R-410A) refrigerant.
- B. Unit Cabinet
  1. Unit cabinet shall be constructed of galvanized steel and shall be bonderized and coated with a pre-painted baked enamel finish on all externally exposed surfaces. Unit cabinet exterior paint shall be: film thickness, (dry) 0.003 inches minimum, gloss (per ASTM D523, 60°F): 60, hardness: H-2H pencil hardness.
  2. Evaporator fan compartment interior cabinet insulation shall conform to AHRI Standards 210/240 or 340/360 minimum exterior sweat criteria. Interior surfaces shall be insulated with a minimum ½" thick, 1 pound density, flexible fiberglass insulation, neoprene coated on the air side. Aluminum foil-faced fiberglass insulation shall be used in the gas heat compartment.
  3. Base of unit shall have a minimum of four locations for thru-the-base gas and electrical connections.
  4. Base Rail:
    - a. Unit shall have base rails on a minimum of 2 sides.
    - b. Holes shall be provided in the base rails for rigging shackles to facilitate maneuvering and overhead rigging.
    - c. Holes shall be provided in the base rail for moving the rooftop by fork truck.
    - d. Base rail shall be a minimum of 16-gauge thickness.
  5. Condensate pan and connections:
    - a. Shall be a sloped condensate drain pan made of a non-corrosive material.
    - b. Shall comply with ASHRAE Standard 62.
    - c. Shall use a ¾"-14 NPT drain connection possible either through the bottom or side



- of the drain pan.
- d. Connection shall be made per manufacturer's recommendations.
- 6. Top panel shall be a single piece top panel on all models.
- 7. Gas Connections:
  - a. All gas piping connecting to unit gas valve shall enter the unit cabinet at a single location on side of unit (horizontal plane).
  - b. Thru-the-base capability
    - 1) Standard unit shall have a thru-the-base gas-line location using a raised, embossed portion of the unit basepan.
    - 2) No basepan penetration, other than those authorized by the manufacturer, is permitted.
- 8. Electrical Connections
  - a. All unit power wiring shall enter unit cabinet at a single, factory-prepared, knockout location.
  - b. Thru-the-base capability.
    - 1) Standard unit shall have a thru-the-base electrical location(s) using a raised, embossed portion of the unit basepan.
    - 2) No basepan penetration, other than those authorized by the manufacturer, is permitted.
- 9. Component access panels (standard)
  - a. Cabinet panels shall be easily removable for servicing.
  - b. Unit shall have one factory installed, tool-less, removable, filter access panel.
  - c. Panels covering control box, indoor fan, indoor fan motor, gas components (where applicable), and compressors shall have molded composite handles.
  - d. Handles shall be UV modified, composite. They shall be permanently attached and recessed into the panel.
  - e. Screws on the vertical portion of all removable access panel shall engage into heat resistant, molded composite collars.
  - f. Collars shall be removable and easily replaceable using manufacturer recommended parts.
- C. Gas Heat
  - 1. General
    - a. Heat exchanger shall be an induced draft design. Positive pressure heat exchanger designs shall not be allowed.
    - b. Shall incorporate a direct--spark ignition system and redundant main gas valve.
    - c. Gas supply pressure at the inlet to the rooftop unit gas valve must match that required by the manufacturer.
  - 2. The heat exchanger shall be controlled by an integrated gas controller (IGC) microprocessor.
    - a. IGC board shall notify users of fault using an LED (light-emitting diode).
    - b. The LED shall be visible without removing the control box access panel.
    - c. IGC board shall contain algorithms that modify evaporator--fan operation to prevent future cycling on high temperature limit switch.
    - d. Unit shall be equipped with anti-cycle protection with one short cycle on unit flame rollout switch or 4 continuous short cycles on the high temperature limit switch. Fault indication shall be made using an LED.
  - 3. Standard heat exchanger construction
    - a. Heat exchanger shall be of the tubular-section type constructed of a minimum of 20-gauge steel coated with a nominal 1.2 mil aluminum-silicone alloy for corrosion resistance.
    - b. Burners shall be of the in-shot type constructed of aluminum--coated steel.

- c. Burners shall incorporate orifices for rated heat output up to 2000 ft elevation, depending on local gas supply conditions.
  - d. Each heat exchanger tube shall contain multiple dimples for increased heating effectiveness.
- D. Coils
1. Standard Aluminum Fin/Copper Tube Coils:
    - a. Standard evaporator and condenser coils shall have aluminum lanced plate fins mechanically bonded to seamless internally grooved copper tubes with all joints brazed.
    - b. Evaporator coils shall be leak tested to 150 psig, pressure tested to 450 psig, and qualified to UL 1995 burst test at 1775 psig.
    - c. Condenser coils shall be leak tested to 150 psig, pressure tested to 650 psig, and qualified to UL 1995 burst test at 1980 psig.
- E. Insulation
1. Evaporator fan compartment:
    - a. Interior cabinet surfaces shall be insulated with a minimum ½" thick, minimum 1 ½ lb. density, flexible fiberglass insulation bonded with a phenolic binder, neoprene coated on the air side.
    - b. Insulation and adhesive shall meet NFPA 90A requirements for flame spread and smoke generation.
  2. Gas heat compartment:
    - a. Aluminum foil-faced fiberglass insulation shall be used.
    - b. Insulation and adhesive shall meet NFPA 90A requirements for flame spread and smoke generation.
- F. Filter Section
1. Unit shall use only one filter size, standard and commercially available. Multiple sizes are not acceptable. Filter section shall consist of factory-installed, low velocity, throw-away 2-in. thick fiberglass filters.
  2. Filters shall be accessible through an access panel with "no-tool" removal and held in place by a pivoting filter tray.
- G. Refrigerant Components
1. Refrigerant circuit shall include the following control, safety, and maintenance features:
    - a. Fixed orifice metering system.
    - b. Refrigerant filter drier - solid core design.
    - c. Service gauge connections on suction and discharge lines.
    - d. Pressure gauge access through a specially designed access port in the top panel of the unit.
  2. Gauge Access Port
    - a. There shall be gauge line access port in the skin of the rooftop, covered by a black, removable plug.
    - b. The plug shall be easy to remove and replace.
    - c. When the plug is removed, the gauge access port shall enable maintenance personnel to route their pressure gauge lines.
    - d. This gauge access port shall facilitate correct and accurate condenser pressure readings by enabling the reading with the compressor access panel on.
    - e. The plug shall be made of a leak proof, UV-resistant, composite material.
  3. Compressors
    - a. Unit shall use fully hermetic, scroll compressor for each independent refrigeration circuit. Compressor motors shall be cooled by refrigerant gas passing through motor windings.

- b. Compressors shall be internally protected from high discharge temperature conditions. Compressors shall be protected from an over-temperature and over-amperage conditions by an internal, motor overload device.
  - c. Compressor shall be factory mounted on rubber grommets.
  - d. Compressor motors shall have internal line break thermal, current overload and high-pressure differential protection.
  - e. Crankcase heaters shall not be required for normal operating range, unless required by compressor manufacturer due to refrigerant charge limits.
  - f. Compressors shall be of a single stage cooling capacity design
- H. Evaporator Fan and Motor with EcoBlue™ Technology
- 1. Direct Drive Evaporator Fan Motor:
    - a. Shall be a ECM motor design, shall have permanently lubricated bearings, shall have inherent automatic-reset thermal overload protection, and shall have slow ramp up to speed capabilities.
  - 2. Evaporator Fan:
    - a. Shall be easily set with selection switch and adjustment pot on unit control board.
    - b. Blower fan shall be a vane axial fan design with 75% less moving parts than a conventional belt drive system.
    - c. Shall be constructed of a cast aluminum stator and high impact composite material on rotor and air inlet casing.
    - d. Shall be a patented pending design with a corrosion resistant material and dynamically balanced.
    - e. Shall have slow ramp up to speed capabilities.
- I. Condenser Fans and Motors
- 1. Condenser fan motors shall be totally enclosed, shall use permanently lubricated bearings, shall have inherent thermal overload protection with an automatic reset feature, and shall use a shaft-down design.
  - 2. Condenser fans shall be a direct-driven propeller type fan constructed of high impact composite material.
  - 3. Shall have high impact composite blades completely formed into one piece without blade fasteners or connectors and shall be dynamically balanced.
- J. Thermostats
- 1. Thermostat must
    - a. Energize both “W” and “G” when calling for heat.
    - b. Have capability to energize 2 different stages of cooling, and 2 different stages of heating.
    - c. Include capability for occupancy scheduling.
- K. Electric and Electronic Control System for HVAC
- 1. Shall be complete with self-contained low-voltage control circuit protected by a resettable circuit breaker on the 24-v transformer side. Transformer shall have 75VA capability.
  - 2. Shall utilize color-coded wiring.
  - 3. Shall include a Unit Control Board to conveniently and safely provide connection points for vital control functions such as: smoke detectors, phase monitor, gas controller, economizer, thermostat, DDC control options, and low and high-pressure switches. Controller shall also provide an intuitive means to adjust the indoor fan speed through a simple switch and pot adjustment design.
  - 4. The heat exchanger shall be controlled by an integrated gas controller (IGC) microprocessor.
  - 5. Unit shall include a minimum of one 8-pin screw terminal connection board for connection of control wiring.

6. Safeties:
  - a. Compressor over-temperature, over-current, high internal pressure differential.
  - b. Low-pressure switch.
    - 1) Low-pressure switch shall use different color wire than the high-pressure switch.
  - c. High-pressure switch.
    - 1) High pressure switch shall use different color wire than the low-pressure switch.
  - d. Automatic reset, motor thermal overload protector.
7. Heating section shall be provided with the following minimum protections:
  - a. High-temperature limit switches.
  - b. Induced draft motor speed sensor.
  - c. Flame rollout switch.
  - d. Flame proving controls.
- L. Options/Accessories to be provided
  1. Integrated Vertical Economizer X, Ultra Low Leak model, factory installed
    - a. Integrated, gear driven opposing modulating blade design type capable of simultaneous economizer and compressor operation. Damper blades shall be galvanized steel with composite gears. Plastic or composite blades on intake or return shall not be acceptable.
    - b. Economizer shall include all hardware and controls to provide free cooling with outdoor air when temperature and/or humidity are below setpoints.
    - c. Shall be equipped with gear driven dampers for both the outdoor ventilation air and the return air for positive air stream control.
    - d. Ultra Low Leak design meets California Title 24 section 140.4 and ASHRAE 90.1 requirements for 4 cfm per square foot on the outside air dampers and 10 cfm per square foot on the return dampers.
    - e. Economizer controller shall be the Honeywell W7220, field mounted in the unit's control box. The economizer shall provide:
      - 1) 2-line LCD interface screen for setup, configuration and troubleshooting.
      - 2) On-board Fault Detection and Diagnostics (FDD) that senses and alerts when the economizer is not operating properly, per California Title 24, ASHRAE 90.1 and IECC .
      - 3) Sensor failure loss of communication identification.
      - 4) Automatic sensor detection.
      - 5) Capabilities for use with multiple-speed or single speed indoor fan systems.
      - 6) Utilize digital sensors: Dry bulb and Enthalpy.
    - f. Shall be capable of introducing up to 100% outdoor air.
    - g. Shall be equipped with a barometric relief damper capable of relieving up to 100% return air and contain seals that meet ASHRAE 90.1 requirements.
    - h. Shall be designed to close damper(s) during loss-of-power situations with spring return built into motor.
    - i. Dry bulb outdoor air temperature sensor shall be provided as standard. Outdoor air sensor setpoint shall be adjustable and shall range from 40 to 100°F. Additional sensor options shall be available as accessories.
    - j. The economizer controller shall also provide control of an accessory power exhaust unit function. Factory set at 100%, with a range of 0% to 100%.
    - k. The economizer shall maintain minimum airflow into the building during occupied period and provide design ventilation rate for full occupancy.
    - l. Dampers shall be completely closed when the unit is in the unoccupied mode.
    - m. Economizer controller shall accept a 2 10 Vdc CO2 sensor input for IAQ/DCV

- control. In this mode, dampers shall modulate the outdoor air damper to provide ventilation based on the sensor input.
- n. Compressor lockout temperature on W7220 control is adjustable from -45°F to 80°F, set at a factory de-fault of 32°F. W7212 control opens at 35°F and closes at 50°F.
  - o. Actuator shall be direct coupled to economizer gear. No linkage arms or control rods shall be acceptable.
  - p. Economizer controller shall provide indications when in free cooling mode, in the DCV mode, or the exhaust fan contact is closed.
- 2. Hinged Access Panels:
    - a. Shall provide easy access through integrated quarter turn latches.
    - b. Shall be on major panels of: filter, control box, fan motor, and compressor.
  - 3. Condenser Coil Hail Guard Assembly
    - a. Shall protect against damage from hail.
    - b. Shall be either hood style or louvered.

## 2.19 MAKE UP AIR (KITCHEN)

- A. Greenheck IGX series make-up air units as scheduled on the Drawings or approved equal. The units shall have integral heating and cooling, shall be fully assembled at the factory and consist of a double wall insulated metal cabinet, evaporative cooling module, condensate drain pan, motorized intake damper, sensors, curb assembly, service receptacle, freeze protection, filter assembly for intake air, supply air blower assembly and electrical control center. All specified components and internal accessories factory installed and tested and prepared for single-point high voltage connection. Units shall have "Permatector" coating, concrete gray (RAL 7023)
- B. Cabinet
  - 1. Materials: Formed, double wall insulated metal cabinet, fabricated to permit access to internal components for maintenance.
  - 2. Outside casing: Pre-painted components as supplied by the factory shall have polyester urethane powder coat paint on 18-gauge G60 galvaneal steel. Base rail is 12 gauge, galvanized (G90) steel.
  - 3. Internal assemblies: 24 gauge, galvanized (G90) steel except for motor supports which shall be minimum 14 gauge galvanized (G90) steel.
  - 4. Cabinet Insulation: Comply with NFPA 90A and NFPA 90B and erosion requirements of UL 181.
    - a. Materials: Fiberglass insulation. If insulation other than fiberglass is used, it must also meet the Fire Hazard Classification shown below.
    - b. Thickness: 1 inch
    - c. Fire Hazard Classification: Maximum flame spread of 25 and smoke developed of 50, when tested in accordance with ASTM C 411.
    - d. Location and application: Insulation shall be on the entire double wall unit.
- C. Access Panels: Unit shall be equipped with hinged access panels to provide easy access to all major components. Access panels shall be fabricated of 18-gauge galvanized G90 steel and shall incorporate a formed drip edge.
- D. Supply Air blower assembly: Blower assembly consists of an electric motor and a belt driven, double width, and double inlet forward curve blower. Assembly shall be mounted on heavy gauge galvanized rails and further mounted on minimum 1.125 inch thick neoprene vibration isolators.
- E. Control panel / connections: unit shall have an electrical control center where all high and low voltage connections are made. Control center shall be constructed to permit single-point high

voltage power supply connections.

- F. Indirect Gas-Fired Furnace:
  - 1. Shall be ETL Certified as a component of the unit.
  - 2. Shall have an integral combustion gas blower.
  - 3. Shall be ETL Certified for installation downstream of a cooling coil.
  - 4. Shall have fault sensors to provide fault conditions to optional digital controller or building controls.
  - 5. Shall have 4-pass tubular heat exchangers, constructed of type 409 stainless steel. Heat exchanger tubes shall be installed on the vest plate by means of swaged assembly, welded connections are not acceptable. Heat exchanger tubes shall be supported by a minimum of two fabricated assemblies that support the tubes and also permit expansion and contraction of the tubes.
  - 6. Heat exchanger shall have a 1-year warranty.
  - 7. Furnace control shall be single furnace, 4:1 electronic modulating.
  - 8. Shall be encased in a weather-tight metal housing with intake air vents. Large, metal lift-off or hinged door shall provide easy access to the enclosed vest plate, control circuitry, gas train, burner assembly and exhaust blower.
- G. Condensate Drain Pan: Drain Pan shall be an integral part of the unit whenever a cooling option is included. Pan shall be formed of welded austenitic stainless-steel sheet material and provided with a welded stainless-steel drain connection at the front for connection to a P trap. Drain pan shall be sloped in two directions to provide positive draining and drain connector shall be sealed at penetration through cabinet wall.
- H. P-Trap: contractor shall provide, or fabricate, and install an appropriate P trap, in accordance with all local and area codes and Best Practices.
- I. Evaporative Cooling Module: Media holder and sump pan shall be fabricated of stainless steel and shall use CELdek media. Gutter and sump shall be sized to supply the system with enough water to operate at its maximum flow rate and not overflow when the system is shut down. Cooling module shall be equipped with recirculating pump with auto drain and flush. Louvered intake shall be provided with 2" aluminum mesh filters.
- J. Motorized dampers/Intake Air: Motorized damper of low leakage shall be factory installed.
- K. Sensors are considered to be part of various optional operational modes or device controllers and are to be factory supplied and installed as specified.
- L. Curb Assembly: A curb assembly made of 14-gauge galvanized steel shall be provided by the factory for assembly and installation. The curb assembly shall provide perimeter support of the entire unit and shall have duct adapter for supply air. Curb assembly shall enclose the underside of the unit and shall be sized to fit into a recess in the bottom of the unit. Contractor shall be responsible for coordinating with roofing contractor to ensure curb unit is properly flashed to provide protection against weather/moisture penetration. Contractor shall provide and install 1-inch insulation for the curb assembly. Roof curb to be Greenheck GPI.
- M. Service Receptacle: 120 VAC GFCI service outlet shall be factory-provided and installed by this contractor.
- N. Blower
  - 1. Blower section construction, Supply Air: Belt drive motor and blower shall be assembled onto a minimum 14-gauge galvanized steel platform and must have neoprene vibration isolation devices, minimum of 1-1/8 inches thick.
  - 2. Blower assemblies: Shall be statically and dynamically balanced and designed for continuous operation at maximum rated fan speed and horsepower.

3. Centrifugal blower housing: Formed and reinforced steel panels to make curved scroll housing with shaped cutoff.
  4. Forward curved blower (fan) wheels: Galvanized or aluminum construction with inlet flange and shallow blades curved forward in direction of airflow. Mechanically attached to shaft with set screws.
  5. Blower section motor source quality control: Blower performance shall be factory tested for flow rate, pressure, power, air density, rotation speed and efficiency. Ratings are to be established in accordance with AMCA 210, "Laboratory Methods of Testing Fans for Rating".
- O. Motors
1. General: Motors shall be heavy-duty, permanently lubricated type to match the fan load and furnished at the specified voltage, phase and enclosure. Drives shall be sized for a minimum of 150% of driven horsepower and pulleys shall be fully machined cast-type, keyed and fully secured to the fan wheel and motor shafts. Electric motors of ten horsepower or less shall be supplied with an adjustable drive pulley.
  2. Motors shall be 60 cycle, 3 phase 208 volt.
  3. Unit Controls: This unit shall be controlled by a factory-installed microprocessor programmable controller (DDC) that is connected to various optional sensors.
- P. Variable Frequency Drive (VFD): Units shall have factory installed variable frequency drives for modulation of the blower motors The VFDs shall be factory-programmed for unit-specific requirements and shall not require additional field programming to operate.
- Q. Sensors to be provided with the unit:
1. Heating Inlet Air Sensor
  2. Cooling Inlet Air Sensor
  3. Dirty Filter Switch
  4. 120V24V Smoke Detector
- R. Filters
1. Unit shall have 2" thick MERV 13 disposable pleated filters located in the outdoor air intake and shall be accessible from the exterior of the unit.

## 2.20 REGISTERS, GRILLES AND DIFFUSERS

- A. Air terminals shall be Titus, as scheduled on the Drawings or equal Price.
- B. All terminals shall be steel and shall be factory painted. The finish shall be #26 white. The finish shall be an anodic acrylic paint, baked at 315°F for 30 minutes. The pencil hardness must be HB to H. The paint must pass a 100-hour ASTM B117 Corrosive Environments Salt Spray Test without creepage, blistering or deterioration of film. The paint must pass a 250-hour ASTM D870 Water Immersion Test. The paint must also pass the ASTM D2794 Reverse Impact Cracking Test with a 50-inch pound force applied.
- C. Air terminals for installation in gypsum board shall have a 1" border for surface mounting. All air terminals for installation in lay-in ceilings shall have a lay-in frame to match the specified grid system
1. Radial Diffusers (CD)
    - a. Round ceiling (radial) diffusers shall be Titus model TMR (steel). The TMR model shall have three round cones and round neck inlets. Two horizontal discharge settings shall allow the diffuser to be field adjusted for different flow rate conditions. The two inner cones must be easily removable as a unit using a spring lock mechanism. Round diffuser shall be constructed of 18-gauge steel.
  2. Ceiling Diffusers (CD-1), Ceiling Return (CR)

- a. Ceiling diffusers shall be Titus Model TDC (steel), horizontal discharge pattern. A square or rectangular inlet shall be an integral part of the frame assembly and a transition piece shall be available to facilitate attachment of round duct. An inner core assembly consisting of fixed deflection louvers shall be available in one-, two-, three- or four-way horizontal discharge patterns. The inner core assembly must be removable in the field without tools for easy installation, cleaning or damper adjustment.
- b. The damper must be operable from the face of the diffuser by removing the spring-loaded inner core assembly. Throw Reducing Vanes (TRV) must be available to deflect a horizontal discharge airstream from each side of the TDC diffuser into diverging airstreams.
3. Exposed Supply Diffusers - Steel Supply Grilles (WSR)
  - a. Steel supply grilles shall be Titus Model 300RL (double deflection). The deflection blades shall be available parallel to the long dimension of the grille. Construction shall be of steel with a 1¼-inch wide border on all sides. Screw holes shall be countersunk for a neat appearance. Corners shall be welded with full penetration resistance welds.
  - b. Deflection blades shall be contoured to a specifically designed and tested cross-section to meet published test performance data. Blades shall be spaced on ¾-inch centers. Blades shall have steel friction pivots on both ends to allow individual blade adjustment without loosening or rattling. Plastic blade pivots are not acceptable.
4. Wall Return Grills (WRG), Transfer Grille (TG)
  - a. Steel return grilles shall be Titus Model 355R (½-inch blade spacing). The fixed deflection blades shall be available parallel to the long dimension of the grille. Construction shall be of steel with a 1¼-inch wide border on all sides. Screw holes shall be countersunk. Corners shall be welded with full penetration resistance welds.
  - b. Deflection blades shall be contoured to a specifically designed and tested cross-section to meet published test performance data. Blades shall be firmly held in place by mullions from behind the grille and fixed to the grille by welding in place. Blade deflection angle shall be available at 35°.
5. Exhaust Grille / Ceiling Return (EG)
  - a. Return grilles shall be Titus Model 50F5 (with damper). Return grilles must provide a free area of at least 90%. Outer borders shall be constructed of heavy extruded aluminum with a thickness of 0.040-0.050 inch and shall have countersunk screw holes for a neat appearance. Border width shall be 1¼ inches on all sides and shall be interlocked at the four corners and mechanically staked to form a rigid frame. Aluminum grid: ½ x ½ x ½ inch
6. Door Louvers (DL)
  - a. Door return grilles shall be Titus Model T-700. Construction shall be of steel with a 1¼-inch border width. The border and blades shall be of 20-gauge steel. Inverted V-blades with a deflection angle of 77° shall be used to create a sight proof design and provide additional stiffness to the grille. Corners shall be welded with full penetration resistance welds with a reinforcing patch for extra strength. Screw holes shall be countersunk.

## 2.21 LINEAR SLOT DIFFUSERS

- A. Titus "Flowbar" linear diffuser system, FL series, as shown on the Drawings. The slot diffusers shall integrate into the ceiling system. Where curved linear slot diffusers are indicated, they shall be stretched formed to the exact radii required. Rolled or segmented linear



slot diffusers will not be accepted.

- B. The linear slot diffusers shall have a single slot unless shown otherwise and shall be capable of being used for supply air, return air, exhaust air or any combination thereof.
- C. The linear slot diffusers shall be capable of supporting the ceiling system. Linear diffusers supported by screws in the flanges or from air plenums are unacceptable. For lay-in ceiling, provide hanger wire support clips that are integral with the linear slot diffusers allowing the linear slot diffusers to be supported from the building structure with ceiling wire. For hard ceilings, provide clips that are integral with the linear slot diffusers allowing the diffusers to be secured directly to the ceiling framing without the requirement for hanger supports. Provide spline clips to secure joints and ceiling tees to the diffusers.
- D. Provide ends and corners as required. Ends shall be butt type, field installed, or mitered picture frame type factory installed, as shown on the drawings. Corners shall be mitered one-piece unit.
- E. Pattern controllers shall be one-piece extruded aluminum, 24" long maximum, positioned between spring loaded spacers. Pattern controllers shall allow the airstream to be directed flat against the ceiling in either direction or downward as well as allowing throw reduction every two feet along the entire length of the linear slot diffusers. The airstream shall be maintained at the ceiling plane and shall not dump when volume is reduced. Only extruded aluminum pattern controllers are acceptable. Where shown or noted pattern controllers shall be designed to allow the airstream to be jetted into the occupied space and be adjustable to vector the airstream as required.
- F. Material shall be minimum wall thickness 0.062 inches extruded aluminum. Spring steel retainers shall be used under the spacers to hold the slot diffusers assembly tightly together and allow the slot diffusers to be disassembled easily for field trimming. Materials other than extruded aluminum and spring steel will not be accepted.
- G. Flanges exposed to view shall be painted factory standard white. All other surfaces shall be painted flat black.
- H. Plenums shall be minimum 24-gauge galvanized steel and lined inside with black matte fiberglass insulation. Hoods shall be 51 percent free area and constructed of 24-gauge perforated sheet metal painted flat black.
- I. Where shown on the drawings or otherwise indicated, provide a friction type volume damper located in the entry collar of the supply air plenum, accessible through the slot diffuser.
- J. Air test and balance of linear and modular slot diffusers systems shall be by this section and be in accordance with the testing and balancing portion section of the specifications. Position all FlowBar pattern controllers in their normal operation positions and perform all air testing and balancing of all slot diffuser systems in full accordance with manufacturer's recommendations.
- K. All slot diffusers shall be performance tested with air plenums as a composite assembly in full accordance with ASHRAE, and/or ARI standards.
- L. Diffusers shall be selected to achieve a throw to room length ratio which meets the requirements of the ASHRAE Fundamentals Handbook, Chapter 32, Table 4, at both maximum design flow rate, and for VAV systems, at the minimum flow rate expected during partial occupancy. Diffusers shall be selected to achieve a minimum of 70 percent ADPI over the range of expected loads in the space. The diffusers' reported performance shall be based on tests conducted in accordance with ASHRAE Standard 70. ADPI performance on at least one unit size of the selected diffuser shall have been tested in accordance with ASHRAE Standard 113, to validate conformance and applicability to the ASHRAE table.

## 2.22 ACCESS PANELS

- A. Where construction is not inherently accessible, provide adequately sized and conveniently located access doors in ceilings, walls, and furring for access to controls and for servicing valves, equipment, etc.
  - 1. Fire Rated walls and ceilings: Milcor, Style UFR, U.L. Class B, 1½ hour rating, insulated, self-closing, self-latching, flush key operated cylinder lock, interior latch release. Minimum size shall be 12" x 12". Provide larger sizes where required.
  - 2. Drywall ceilings or walls: Milcor, Style DW, prime coated steel, flush screwdriver-operated cam lock. Minimum size shall be 12" x 12". Provide larger sizes where required.
  - 3. Masonry walls: Milcor, Style M, prime coated steel, flush screwdriver-operated cam lock. Minimum size shall be 12" x 12". Provide larger sizes where required.
  - 4. Tiled walls: Milcor, Style MS, satin finish stainless steel, flush screwdriver-operated cam lock.
  - 5. Plastered walls and ceilings: Milcor, Style K, prime coated steel, flush screwdriver-operated cam lock. Minimum size shall be 12" x 12". Provide larger sizes where required.
- B. Doors shall be delivered to the General Contractor for installation.

## 2.23 VIBRATION ISOLATORS

- A. Unless otherwise noted on the equipment schedule, all mechanical equipment shall be mounted on vibration isolators to prevent the transmission of vibration and mechanically transmitted sound to the building structure. All isolators shall be Mason Industries, Kinetics, or approved equal. Rated deflections and model numbers shall be as scheduled on the drawings.
- B. Spring equipment mounts, earthquake motioned restrained:
  - 1. Mounts shall incorporate a single spring vibration isolator built into a welded steel mount assembly, designed and engineered to limit movement of supported equipment during an earthquake without degrading the vibration isolation of the spring during normal equipment operating conditions.
  - 2. Mounts shall incorporate a welded steel plate and motion limit assembly, and steel spring isolator, engineered as a system to accept a force of 1.3 times the rated load capacity of the spring isolator without yield or failure, and shall limit movement of the point of level bolt connection to supported equipment to 0.75 inches in any direction, relative to any fixed point on the mount assembly, while subjected to the minimum force specified.
  - 3. The motion limit assembly shall be welded to a steel base plate having a ¼" thick ribbed neoprene noise stop pad, and drilled holes for bolting to supporting structures.
  - 4. Springs shall be wound steel, using high strength, heat treated spring alloy steel and shall have a horizontal spring stiffness equal to or greater than 1.3 times the rated vertical spring stiffness. The outside diameter of each spring shall be a minimum of 0.8 times the rated vertical spring height.
  - 5. Springs shall be selected to provide the tabulated minimum operating static deflections and shall provide a 50% overload capacity before reaching solid state. Springs shall be designed to reach solid state before exceeding the spring steel fatigue point.

## 2.24 DUCTWORK

- A. Sheet Metal Ductwork:
  - 1. Ducts and plenums shall be fabricated and installed in conformance with the latest editions of: NFPA Pamphlet No. 90A; California Building Code; California Mechanical

Code and the SMACNA HVAC Duct Construction Standards (Metal & Flexible). Ducts and plenums shall be constructed of G-60 coated galvanized steel of lockforming grade conforming to ASTM A653 and A924 standards. Seals shall be airtight Class "B" seals at all transverse joints and longitudinal seams. Tables and figures hereinafter referenced are from the 2005 edition of the SMACNA HVAC Duct Construction Standards (Metal and Flexible).

2. Rectangular duct construction shall conform to Table 2-3. All transverse joints shall be flanged per Table 2-32, with corner closures or "Duct Mate" flanged connections with corner closures per Figure 2-16 or 2-17. Elbows shall be standard radius (Type RE 1) or square throat with vanes (Type RE 2) per Figure 4-2, with double thickness turning vanes per Figures 4-3 and 4-4. Offsets and transitions shall be per Figure 4-7. Supply, return, and exhaust branch connections shall be per Figure 4-5 or 4-6. Splitters SHALL NOT be used.
3. Round ducts shall be spiral, United McGill or equal. All transverse joints and longitudinal seams shall have Class "B" seals. All branches in round duct systems shall be made with factory fabricated reducing wye branches. Duct turns shall be made with standard, factory fabricated, three-piece elbows.
4. Lined ducts shall be fabricated such that the net inside dimensions equals the duct sizes shown on the Drawings.
5. Flexible ducts shall be acoustical type, Flexmaster "6M", Casco "Silent Flex - SF-18M", or approved equal. Flexible ducts shall be used only where shown on the Drawings, and maximum length of any given flexible duct shall not exceed 7 feet. Galvanized sheet metal elbows shall be used for turns greater than 45 degrees on flexible ducts 10 inches and larger. Connections to rectangular ducts shall be made with "spin-in" fittings with air scoops. The installation of flexible ducts shall conform to Figure 3-10, with the exceptions noted herein.
6. Supports for horizontal ducts and plenums shall be fabricated per Figures 5-5 and 5-6 and Tables 5-1, 5-2 and 5-3. The maximum distance between hangers shall be 8 feet for rectangular ducts and 12 feet for round ducts. Attachments to the structure shall be made with adequately sized lag bolts for strap hangers and adequately sized machine bolts and side beam brackets for rod hangers. Supports for vertical ducts shall be band iron strap or angle bracket type per Figures 5-8 and 5-9.
7. All roof-mounted ductwork shall be water-tight and sloped to shed water. All transverse joints shall be T-25 flanged Ductmate "25" or approved equal.
8. Outside air intakes shall be type 316 stainless steel.
9. Ducts and plenums shall be fabricated and installed in conformance with the latest editions of: NFPA Pamphlet No. 90A; California Building Code; California Mechanical Code and the SMACNA HVAC Duct Construction Standards (Metal & Flexible). Ducts and plenums shall be constructed of hot dipped galvanized mild steel and shall have airtight Class "B" seals at all transverse joints and longitudinal seams. Tables and figures hereinafter referenced are from the 2005 edition of the SMACNA HVAC Duct Construction Standards (Metal and Flexible).
10. Rectangular duct construction shall conform to Table 2-3. All transverse joints shall be flanged per Table 2-32, with corner closures or "Duct Mate" flanged connections with corner closures per Figure 2-17. Elbows shall be standard radius (Type RE 1) or square throat with vanes (Type RE 2) per Figure 4-2, with double thickness turning vanes per Figures 4-3 and 4-4. Offsets and transitions shall be per Figure 4-7. Supply, return, and exhaust branch connections shall be per Figure 4-5 or 4-6. Splitters SHALL NOT be used.
11. Round ducts shall be spiral, United McGill or equal. All transverse joints and longitudinal seams shall have Class "B" seals. All branches in round duct systems shall be made with factory fabricated reducing wye branches. Duct turns shall be made with standard, factory fabricated, three-piece elbows.

12. Lined ducts shall be fabricated such that the net inside dimensions equals the duct sizes shown on the Drawings.
  13. Flexible ducts shall be Flexmaster "8M" or approved equal. Flexible ducts shall be used only where shown on the Drawings, and maximum length of any given flexible duct shall not exceed 7'. Galvanized sheet metal elbows shall be used for turns greater than 45° on flexible ducts 10" and larger. Connections to rectangular ducts shall be made with "spin-in" fittings with air scoops. The installation of flexible ducts shall conform to Figure 3-10, with the exceptions noted herein.
  14. Supports for horizontal ducts and plenums shall be fabricated per Figures 5-5 and 5-6 and Tables 5-1, 5-2 and 5-3. The maximum distance between hangers shall be eight feet for rectangular ducts and twelve feet for round ducts. Attachments to the structure shall be made with adequately sized lag bolts for straphangers and adequately sized machine bolts and side beam brackets for rod hangers. Supports for vertical ducts shall be band iron strap or angle bracket type per Figure 5-8 and 5-9.
  15. All roof-mounted ductwork shall be water-tight and sloped to shed water. All transverse joints shall be T-25 flanged, Ductmate "25", or approved equal.
  16. Outside air intakes shall be type 316 stainless steel.
- B. Fiberglass Ductwork:
1. Fiberglass ductwork is unacceptable and may not be used on this project.
- C. Specialties:
1. Duct Mounted Access Doors
    - a. Including those for removing filters, duct access doors shall be fabricated as detailed in Figure 7-2, with sash locks, piano hinges, and cam latches. Round duct shall be fabricated as detailed in Figure 7-3.
    - b. Access doors shall be double wall, rectangular, insulated or uninsulated same as duct. Insulation fill and thickness shall be as indicated for pressure class.
    - c. Access doors shall have a vision panel and an unobstructed full swing.
    - d. Fabricate doors airtight and suitable for duct pressure class.
  2. Dampers:
    - a. Provide butterfly or multiple blade dampers where indicated on the Drawings or as required for balancing air quantities, to values shown without generating excessive noise. Provide Duro-Dyne "KS-385", or approved equal, locking quadrants on each manual damper. Locate dampers in furred ceilings near access panels where possible.
    - b. Butterfly dampers shall be constructed as per Figure 7-4, Figures A, B, and C.
    - c. Multi-blade dampers shall conform to Figure 7-5.
    - d. Motorized dampers - See Temperature Controls.
  3. Remote Actuators: Young Regulator Company, Round Cable Controlled Dampers Model 5020-CC or 830A-CC (rectangular) and Remote Cable Control System Kit Model 270-301EZ. All dampers in inaccessible ceilings shall have remote actuators.
  4. Air Extractors: Duct mounted volume extractors made of galvanized steel with 1-inch blade spacing, Titus model "AG-45", or equal.
  5. Flexible Duct Connections: Duro-Dyne "Metal-Fab" with Durolon, Ventfabrics "Ventglas", or approved equal. Install at each point where a blower unit is connected to a duct. A minimum clearance of 3" between the duct and the source of vibration shall be maintained. Install per Figure 7-8.
  6. Screens: Install removable bird screens at ALL outside air intakes and exhaust air discharges. Screens shall be fabricated from ½" x 14-gauge mesh secured in full frames. Screens and frames shall be constructed of the same material as the duct, hood, or equipment to which attached.
  7. Access Panels: Milcor, Style M, prime coated steel, or approved equal. Minimum size

shall be 10" x 10". Provide larger sizes where required. Locks shall be flush, screwdriver operated. Provide as required for concealed ducts at all fire dampers, electric duct heaters, and automatic dampers except at suspended acoustical ceilings.

8. Joints: Tape all joints airtight using Hardcast - Carlisle, type "DT" pressure-less tape and "RTA 50" sealant, or McGill AirSeal, "Uni-Flex" duct sealer. Install per manufacturer's directions.

## 2.25 INSULATION

### A. General

1. All duct insulation materials including jackets, tapes, adhesives and coatings shall meet ASTM E84/UL 723 "25/50 Flame Spread/Smoke Development" requirements and NFPA 90A and 90B.

### B. Exterior of Ductwork: (Flexible Duct Wrap)

1. Unless specified to be lined, all ductwork shall be externally insulated by wrapping with formaldehyde-free, flexible glass fiber blanket or inorganic glass mineral wool wrap, with factory applied FSK vapor barrier jacket. Thickness shall be 2 inches unless noted or required otherwise.
2. Duct wrap shall meet the requirements of ASTM C1290, ASTM C553, and ASTM C1136. Corrosiveness shall meet ASTM C665. Mold growth/fungi resistance shall meet ASTM C1338.
  - a. Johns Manville "Microlite FSK", Knauf "Atmosphere Duct Wrap", or Certainteed "SoftTouch" or "Wide Wrap".

### C. Interior of Ductwork: (Duct Liner)

1. All ducts exposed to the weather shall be internally insulated. All other ductwork within 10 feet of a fan (supply and return) shall be internally insulated. Duct liner shall be installed in supply and return ducts and plenums where noted on the Drawings. Exhaust ductwork need not be insulated.
2. Duct liner shall meet the requirements of ASTM C1071. Operating temperature shall meet ASTM C411. Microbial growth shall meet ASTM C1338, and ASTM G21 and G22.
  - a. Type I - Flexible Duct Liner: Johns Manville "Linacoustic RC", Knauf "Atmosphere Duct Liner", or Owens Corning "QuietR Rotary Duct Liner". Thickness shall be 1 ½ inches, unless otherwise noted.
  - b. Type II - Plenum Liner Board: Johns Manville "Linacoustic R-300", Owens Corning "QuiteR Duct Liner Board", or Knauf Insulation "Atmosphere Rigid Plenum Liner". Thickness shall be 1 ½ inches, unless otherwise noted.

### D. Refrigerant Piping:

1. Insulate all refrigerant suction lines, fittings, and valves with flexible elastomeric thermal insulation, Resolco Insul-Phen rigid closed cell phenolic foam, or equal, according to manufacturer's suggested installation procedures, UV protected.
2. Liquid, suction, and hot gas (where applicable) lines shall be insulated individually.
3. Oil equalization lines between multiple condensing units shall be insulated.

### E. Piping insulation thickness shall be as follows:

FLUID TEMPERATURE RANGE (°F)	CONDUCTIVITY RANGE (in Btu-inch per hour per square foot per °F)	INSULATION MEAN RATING TEMPERATURE (°F)	NOMINAL PIPE DIAMETER (in inches)				
			1 and less	1 to <1.5	1.5 to < 4	4 to < 8	8 and larger
			INSULATION THICKNESS REQUIRED (in inches)				
Space cooling systems (chilled water, refrigerant and brine)							
40-60	0.21-0.27	75	0.5	0.5	1.0	1.0	1.0
Below 40	0.20-0.26	50	1.0	1.5	1.5	1.5	1.5

- F. All tanks, expansion tank, pumps, volutes, valves and strainers shall be completely insulated with ½" AP Armaflex glued and sealed vapor tight in place with Armstrong #520 adhesive.

**PART 3 EXECUTION**

**3.01 PROJECT CONDITIONS**

- A. Prior to commencing the work of this Section, the Contractor shall inspect the installed work of other trades and verify that their work is sufficiently complete to permit the start of work under this Section, and that the completed work will be in complete accordance with the original design. In the event of discrepancy, immediately notify the Architect and proceed as directed.

**3.02 GENERAL INSTALLATION**

- A. Provide all necessary cutting in connection with the work of this Section. No structural members shall be drilled, bored, or notched in a manner which will impair their structural capacity. All penetrations of concrete or masonry shall be made with core drills. No cutting shall be done without the approval of the Architect.

**3.03 HEATING & AIR CONDITIONING EQUIPMENT INSTALLATION**

- A. All units shall be set with curbs plumb, level, and securely attached through framed opening with bolts and/or lag screws as noted on the Drawings. Connections to ductwork shall be secured, filter racks shall be aligned, enclosures and ductwork connections shall be fully waterproofed, and all utility and control connections shall be complete.

**3.04 INSULATION**

- A. Exterior Ductwork:
  1. Duct wrap shall be cut in a manner to meet the manufacturers' stretch-out guideline to provide a 2" staple lap and have minimum compression at the corners. All joints shall be lapped 2" and stapled with outward clinching staples 2" on center. The insulation shall be mechanically fastened to the underside of all ducts 24" wide or more using cup-head pins, weld pins, or stick pins with speed clips 18" on center. Insulation shall not be compressed to comply with required installed R-value. All joints and penetrations of the vapor barrier jacket shall be sealed with a minimum 3" wide matching pressure sensitive tape. Pressure-sensitive tape shall be firmly rubbed in place immediately after application using a "squeegee" type tool.
  2. When a vapor seal is required, two coats of vapor retarder mastic reinforced with one layer of 4" wide, open weave glass fabric may be used in lieu of pressure-sensitive tape. Mastic shall be brushed onto joint and glass fabric imbedded in it. A second coat of

mastic shall be brushed over the glass fabric until the fabric is filled. Mastics shall be applied in accordance with application instructions on the container.

- B. Interior Duct Liner
  - 1. Apply to the inside face of ducts, coated side facing air stream. Fasten using fire retardant adhesive and secure with mechanical fasteners at 12" maximum o.c., both directions, for velocities up to 2,500 fpm. Velocities over 2,500 fpm shall have fastener spacing of 6" o.c.
  - 2. Exposed edges must be factory or field coated with adhesive. Metal nosing shall be installed in all liner leading edges facing the airstream at fan discharge, at access doors, and at any interval of lined duct preceded by unlined duct.
  - 3. Insulation with torn or broken coatings shall be removed and replaced. Loose corners, edges, and butt joints will not be accepted.
  - 4. Maximum velocity: 5,000 ft/min.
- C. Refrigerant Piping:
  - 1. The insulation shall be installed in accordance with the manufacturer's instructions. All joints and seams shall be sealed with waterproof vapor retarder adhesive. All pipes exposed to the weather shall be coated to protect the insulation from ultra-violet radiation in accordance with the manufacturer's published instructions.

### 3.05 VRF SPLIT SYSTEM INSTALLATION

- A. Contractor's Qualifications
  - 1. The mechanical contractor shall show having successfully installed a minimum of two Mitsubishi City Multi projects within the past 5 years. Provide for approval prior to construction, a written statement indicating the project names, dates completed, owners name and contact information.
- B. Installer Qualifications
  - 1. Installers for the Mitsubishi systems shall have at least one person factory trained and certified for installation and service of the systems by Mitsubishi Electric. This person shall at all times supervise the installation of all other installers and assure that all work is done in accordance with Mitsubishi requirements. All other installers shall be trained and certified in HVAC installation (included but not limited to refrigerant piping and controls) by a national or regionally recognized organization. Provide for approval, prior to construction, copies of installers certificates or other proof of qualifications.
- C. All units shall be set with curbs plumb, level, and securely attached through framed opening with bolts and/or lag screws as noted on the Drawings. Connections to ductwork shall be secured, filter racks shall be aligned, enclosures and ductwork connections shall be fully waterproofed, and all utility and control connections shall be complete.
- D. General:
  - 1. Rig and install in full accordance with manufacturer's requirements, project drawings, and contract documents. Refer to the manufacturer's installation manual for full requirements.
- E. Location:
  - 1. Locate indoor and outdoor units as indicated on drawings. Provide service clearance per manufacturer's installation manual. Adjust and level outdoor units on support structure.
- F. Components / Piping:
  - 1. Installing contractor shall provide and install all accessories and piping for a fully operational system. Refer to manufacturer's installation manual for full instructions.
  - 2. Traps, filter driers, and sight glasses are NOT to be installed on the refrigerant piping or

- condensate lines.
  - 3. Standard ACR fittings rated for use with R410A are to be used for all connections. Proprietary manufacturer-specific appurtenances are not allowed.
  - 4. Refrigerant pipe for CITY MULTI shall be made of phosphorus deoxidized copper, and has two types.
    - a. ACR Type-L "Annealed Temper": Soft copper pipe, can be easily bent with human's hand.
    - b. ACR Type L "Drawn Temper": Hard copper pipe (Straight pipe), being stronger than Type-O pipe of the same radical thickness.
  - 5. The maximum operation pressure of R410A air conditioner is 4.30 MPa [623psi] . The refrigerant piping should ensure the safety under the maximum operation pressure. Refer to recommend piping specifications in Mitsubishi Electric's engineering manual. Pipes of radical thickness 0.7mm or less shall not be used.
  - 6. Flare connection should follow dimensions provided in manufacturer's installation manuals.
- G. Insulation:
- 1. Refrigerant lines, as well as any valves, shall be insulated end to end with ½" closed-cell pipe insulation. If state or local codes require insulation other than that specified above, the greater insulation shall be used.
- H. Electrical:
- 1. Installing contractor shall coordinate electrical requirements and connections for all power feeds with electrical contractor. Refer to Division 26 for additional information.
- I. Third Party Controls:
- 1. Installing contractor shall coordinate all BAS/BMS control requirements and connections with controls contractor.

### 3.06 DUCTWORK

- A. All ductwork shall be installed within spaces provided, where possible. Ducts shall be installed true to line and grade, fully secured to structural framing with specified hangers and supports, insulated, and vibration isolated.
- B. Each section of supply air ductwork shall be cleaned, dust and oil free, at the shop using a degreasing agent and detergent and sealed airtight at both ends with visqueen and tape. Supply ducts shall be additionally cleaned with a disinfecting solution. Ends of all supply and internally insulated exhaust ducts shall be kept sealed until the time they are joined. When duct sections are joined, wipe down all interior surfaces with a clean tack cloth. If tack cloth shows any dust, then re-clean duct as described above. The intent is that no foreign matter be allowed to enter the ductwork at any time after factory cleaning and during construction.
  - 1. Submit detailed shop and field duct handling procedures for review.
  - 2. Unlined exhaust ducts shall be vacuum cleaned when installed, but shall otherwise be exempt from shop cleaning and sealing.

### 3.07 INSTALLATION, HANGERS AND SUPPORTS

- A. Pipe supports shall be spaced according to CPC 2019, Table 313.3 and sufficiently close to support pipes properly without formation of pockets. Hangers shall be installed at ends of mains and branches.
- B. Install hangers and supports complete with necessary attachments, inserts, bolts, rods, nuts, washers, and other accessories.
- C. No valve or piece of equipment shall be used to support piping.



- D. Pipes through studs or joists shall be isolated from structure with properly sized Hubbard "Hold-Rite" suspension clamps.
- E. Install hangers and supports to allow controlled thermal and seismic movement of piping systems, to permit freedom of movement between pipe anchors, and to facilitate action of expansion joints, expansion loops, expansion bends, and similar units.
- F. Install lateral bracing with pipe hangers and supports to prevent swaying.
- G. Install building attachments within concrete slabs or attach to structural steel. Install additional attachments at concentrated loads, including valves, flanges, and strainers, 2-½ inches and larger and at changes in direction of piping. Install concrete inserts before concrete is placed; fasten inserts to forms and install reinforcing bars through openings at top of inserts.
- H. Installation of piping shall be such that damage cannot result through loading, expansion or contraction of piping. Anchors shall be installed to obtain uniformity of pipe movement.
- I. Flexibility of piping systems must be maintained by the use of flexible devices at critical points at junctions of separate building structures. Braces or anchors shall be designed to damp oscillations or check excessive movement. Flexible devices for piping of gas shall be loops or offsets. Flexible devices for other piping may be loops, Victaulic grooved, or roustabout couplings. Piping at tops and bottoms of risers are critical points where flexibility is required, as well as at changes in direction on long runs of piping 4" and larger.
- J. Tops of risers shall be restrained from motion in horizontal direction, and midpoints shall be anchored in all directions.

### 3.08 TESTS, INSPECTIONS

- A. Make all necessary control adjustments and balancing of air and water flows. Operate the entire system for a period of time not less than three (3) working days for the purpose of proving satisfactory performance. During this period, instruct such persons as the Owner and/or Architect may designate in the proper operation of the systems. Should further adjustment prove necessary, operating tests shall be repeated until a satisfactory test is obtained.
- B. This Contractor shall not allow or cause any work of this Section to be covered or enclosed until it has been inspected, tested, and approved by the Architect and the authorities having jurisdiction over the Work. Should any of this work be enclosed or covered up before such inspection, testing, and approval, this Contractor shall uncover the work, have the necessary inspections, tests, and approvals made and, at NO expense to the Owner, make all repairs necessary to restore both his work and that of other contractors which may have been damaged to be in conformity with the Contract Documents.
- C. Furnish all necessary labor, materials, and equipment for conducting tests, and pay all expenses in connection therewith. Should leaks develop while testing, repairs shall be made, and tests shall be repeated until a satisfactory test is obtained.
  - 1. Condenser water piping shall be hydrostatically tested at 125-psi pressure and proved tight before covering. Tests may be made in sections provided connection to service previously tested is included in each succeeding test. Systems shall be tight for eight hours.

### 3.09 INSTALLATION, REFRIGERANT PIPING

- A. Piping installation shall comply with all federal, state, and local regulations and industry guidelines. In addition, the following practices shall be followed.
  - 1. All piping shall be stored with ends sealed to prevent entry of moisture and debris.

2. A pipe cutter specific to the piping material applied shall be used.
  3. All factory and field cut tube ends shall be de-burred and cleaned.
  4. Flared fittings shall be formed using tools recommended by the equipment manufacturer.
  5. Flare nuts shall be tightened with torque wrench furnished by the equipment manufacturer.
  6. Piping shall be continuously purged with dry nitrogen while soldering. Care shall be taken when soldering near valves or other equipment that may be damaged by extreme heat.
- B. Drawing plans, schematics, and diagrams indicate general location and arrangement of piping systems; indicated locations and arrangements were used to size pipe and calculate friction loss, expansion, pump sizing, and other design considerations. Install piping as indicated unless deviations to layout are approved on Shop Drawings.
- C. Install refrigerant piping according to ASHRAE 15.
- D. Install piping in concealed locations unless otherwise indicated and except in equipment rooms and service areas.
- E. Install piping indicated to be exposed and piping in equipment rooms and service areas at right angles or parallel to building walls. Diagonal runs are prohibited unless specifically indicated otherwise.
- F. Install piping above accessible ceilings to allow sufficient space for ceiling panel removal.
- G. Install piping adjacent to machines to allow service and maintenance.
- H. Install piping free of sags and bends. Install fittings for changes in direction and branch connections. Install piping as short and direct as possible, with a minimum number of joints, elbows, and fittings.
- I. Arrange piping to allow inspection and service of refrigeration equipment. Install valves and specialties in accessible locations to allow for service and inspection. Install access doors or panels as specified in Division 08 Section "Access Doors and Frames" if valves or equipment requiring maintenance is concealed behind finished surfaces.
- J. Install refrigerant piping in protective conduit where installed belowground. Install refrigerant piping in rigid or flexible conduit in locations where exposed to mechanical injury.
- K. Slope refrigerant piping as follows:
1. Install horizontal hot-gas discharge piping with a uniform slope downward away from compressor.
  2. Install horizontal suction lines with a uniform slope downward to compressor.
  3. Use double-suction riser for maximum compressor efficiencies if load variation is expected.
  4. Install traps and double risers to entrain oil in vertical runs.
  5. Liquid lines may be installed level.
- L. When brazing or soldering, remove solenoid-valve coils and sight glasses; also remove valve stems, seats, and packing, and accessible internal parts of refrigerant specialties. Do not apply heat near expansion-valve bulb.
- M. Install piping with adequate clearance between pipe and adjacent walls and hangers or between pipes for insulation installation.
- N. All refrigerant piping and valves shall be identified.

### 3.10 REFRIGERANT PIPING TESTING

- A. Prior to charging with refrigerant, piping shall be tested for leaks under 550 psi pressure using a mixture of 95% nitrogen and 5% hydrogen gas. (WARNING! OXYGEN OR ACETYLENE SHALL NOT BE USED IN PLACE OF DRY NITROGEN. A VIOLENT EXPLOSION MAY RESULT!).
- B. All joints shall be tested for leaks using an electronic hydrogen leak detector. Pressure and leak tests on refrigeration piping and equipment shall be done in accordance with local code requirements and the American Standard Safety Code for Mechanical Refrigeration (ANSI B9.1).
- C. Piping shall be continuously purged with dry nitrogen while brazing. Care shall be taken when soldering near valves or other equipment that may be damaged by extreme heat.
- D. Be sure that all controls, relief valves or rupture discs that could be damaged by test pressure are removed before beginning pressure test.
- E. Precautions shall be taken to keep moisture out of the system, and a drier shall be used.
- F. After successful completion of pressure tests, the entire system shall be purged with dry nitrogen and then evacuated with a standard vacuum pump to remove all moisture and non-condensables. Three evacuations shall be required, and shall be down to 500 microns absolute pressure. Break the first two vacuums with dry nitrogen. Charge with refrigerant after third evacuation.
- G. The contractor shall notify the Architect 48 hours prior to the time and date of the evacuation.
- H. The refrigerant charge shall be calculated and weighed into the system.
- I. Service technicians shall be certified in the use of CFC and HCFC refrigerant recovery and recycling equipment and shall use UL listed and labeled recovery equipment when discharging refrigerant.

### 3.11 CLEANING OF EXISTING DUCTWORK (BUILDING A)

- A. Contractor shall clean the interior of ductwork for existing systems in Building A. Protect the existing areas served from these systems from debris that is loosened as a result of the cleaning process.
- B. Contractor's Qualifications
  - 1. The contractor responsible for performing duct cleaning work shall be properly trained and qualified and possess relevant knowledge and experience before performing work of any type on HVAC Systems. Industry certifications such as the Air Systems Cleaning Specialist (ASCS) or equivalent certification, may demonstrate minimum qualifications.
  - 2. Contractor shall show proof of compliance with specifications of a similar nature within the last twelve months. Projects completed must be of similar size and complexity as this project.
  - 3. The contractor must be in possession of a C-20 California State Contractors License.
- C. Standards
  - 1. The contractor shall perform source removal duct cleaning and clean in accordance with the current published National Air Duct Cleaners Association's (NACDA) Standard ACR.
- D. Scope of Work
  - 1. The HVAC system cleaning contractor to clean all existing supply, return and exhaust air ducts in the building after renovations take place.

- E. HVAC System Assessment and Site Survey
  1. Prior to the commencement of any cleaning work, the cleaning contractor shall perform an assessment of the HVAC system to determine appropriate engineering controls, safety measures, tools, equipment, cleaning products and cleaning methods required to satisfactorily complete the project.
- F. Engineering Controls
  1. The HVAC system cleaning contractor shall use engineering controls to ensure worker and occupant safety, and to prevent cross-contamination. The HVAC system cleaning contractor shall follow specified industry standards and guidelines specific to the project environment/facility.
- G. Equipment Maintenance & Use
  1. All HVAC system cleaning contractor equipment shall be maintained in good working order, consistent with manufacturer's written instructions and applicable jurisdictional requirements.
    - a. Before any equipment is brought onto the work site it shall be cleaned and inspected to ensure that it will not introduce contaminants into the indoor environment or HVAC system.
    - b. All equipment shall be serviced as needed to limit possible cross-contamination from poor hygiene, and/ or unsafe operating conditions for service personnel and building occupants.
    - c. Any activity requiring the opening of contaminated vacuum collection equipment on-site, such as servicing or filter maintenance shall be performed in an appropriate containment area or outside of the building.
    - d. All collection devices, vacuums and other tools and devices shall be cleaned or sealed before relocating to different areas of the building and before removing the equipment from building.
    - e. When using vacuum collection equipment exhausting within the building envelope, the HVAC system cleaning contractor shall utilize equipment fitted with HEPA filtration and the equipment shall have a collection efficiency of 99.97% at 0.3 micron particle size.
- H. HVAC System Cleaning Requirements:
  1. All cleaning and restoration procedures shall achieve the minimum level of visibly clean or the specified level of cleanliness verification as defined in the contractual documents for components within the project scope of work as defined in NADCA Standard ACR.
- I. Negative Duct Pressurization
  1. Prior to and throughout duration of the cleaning process, the HVAC system and associated air duct shall be kept at an appropriate negative pressure differential relative to the indoor non-work area. This negative pressure differential shall be maintained between the portion of the HVAC duct system being cleaned and surrounding indoor occupant spaces.
    - a. Under all circumstances, the HVAC system cleaning contractor shall verify pressurization differential during the project.
    - b. When utilizing vacuum collection equipment exhausting indoors it shall utilize HEPA filtration and the equipment shall have a collection efficiency of 99.97% at 0.3 micron particle size and be capable of retaining dislodged debris.
    - c. All equipment used to create negative duct pressurization that does not have HEPA filtration shall be exhausted outdoors to a location that would not allow re-entrainment.

J. Microbial Agents:

1. Apply antimicrobial agents only when active biological growth is reasonably suspected, or where unacceptable levels of biological contamination have been verified through testing.
2. Apply antimicrobial agents after removal of surface deposits and debris.
3. Apply antimicrobial agents in accordance with antimicrobial agent manufacturer's written recommendations and associated EPA registration listing.

K. Service Openings

1. The HVAC system cleaning contractor shall utilize service openings, as required for proper cleaning, at various points of the HVAC system for physical and mechanical entry, and inspection.
  - a. The HVAC system cleaning contractor shall utilize existing service openings installed in the HVAC system where possible.
  - b. Service openings installed into the system as needed shall not degrade the structural, thermal, or functional integrity of the system and shall comply with applicable UL, SMACNA and NFPA standards, as well as local, regional, and state codes.
  - c. Service openings shall be created in a manner that allows for proper closure and shall not hinder, restrict, or alter the airflow within the air duct.
  - d. Service opening construction materials and methods shall be in compliance with industry standards and local codes, using materials acceptable under those standards and codes.
  - e. The HVAC system cleaning contractor shall use duct access doors and permanent panels fabricated with materials classified for flammability and smoke spread if the material is exposed to the internal airstream.
  - f. All tapes used in the installation and closure of service openings shall meet the requirements of UL 181A.
  - g. Service panels used for closing service openings in the HVAC system shall be of an equivalent gauge or heavier so as to not compromise the structural integrity of the duct.
  - h. Service panels used for closing service openings shall be mechanically fastened (screwed or riveted) at maximum every 4" on center and equally spaced. The panel shall overlap the duct surfaces by a minimum of 1" on all sides.
  - i. Closures must be properly insulated to prevent heat loss/gain or condensation on surfaces within the system.
  - j. Rigid fibrous glass duct systems shall be resealed in accordance with NAIMA recommended practices. Only closure techniques that comply with UL Standard 181 or UL Standard 181A are suitable for fibrous glass duct system closures.
  - k. Access and closure of service openings installed in fibrous glass shall be created and closed in such a manner that there are no exposed fibrous glass edges within the system common to the airstream.
  - l. Any fibrous glass removed during the installation of a service opening shall be paired or replaced with like material of the same thickness so that there are no breaks or openings that would degrade the R value, service rating or vapor/air barrier characteristics.
  - m. All service openings shall be closed with materials meeting UL 181 for smoke generation and flame spread.
  - n. All service openings capable of being re-opened for future inspection or remediation shall be clearly marked and have their location reported to the **owner** in project report documents.
  - o. Cutting service openings into flexible duct is not permitted. Flexible duct shall be

disconnected at the ends as needed for proper cleaning and inspection and shall be properly reconnected.

L. Cleaning Methods

1. All HVAC components included in the scope of work shall be cleaned by using a suitable agitation device to dislodge contaminants from the HVAC component surface and then capturing the contaminants with a vacuum collection device. Acceptable methods will include those which will not potentially damage the integrity of the duct, nor damage porous surface materials such as liners inside the duct or system components.
  - a. The included HVAC components shall be cleaned using source removal mechanical cleaning methods designed to extract contaminants from within the HVAC system and safely remove contaminants from the facility.
  - b. It is the HVAC system cleaning contractor's responsibility to select source removal methods that will render the HVAC system visibly clean and capable of passing cleanliness verification methods as described in NADCA Standard ACR.
  - c. No cleaning method, or combination of methods, shall be used which could potentially damage components of the HVAC system or negatively alter the integrity of the system.
  - d. Wet cleaning, power washing, steam cleaning and any other form of wet process cleaning of HVAC system components shall not damage or result in subsequent damage to the components. Cleaning agents or water shall never be applied to electrical, fibrous glass or other porous HVAC system components.

M. Particulate Collection

1. All methods used shall incorporate the use of vacuum collection devices that are operated continuously during cleaning. A vacuum collection device shall be connected to the component being cleaned through a predetermined opening. The vacuum collection device must be of sufficient power to render all areas being cleaned under negative pressure, such that containment of debris and the protection of the indoor environment are assured. When the vacuum collection device is used to convey air with debris, it shall maintain a sufficient velocity and negative pressure differential in the portion of the mechanical system being cleaned.
  - a. All vacuum devices exhausting air inside the building shall utilize HEPA filtration and the equipment shall have a collection efficiency of 99.97% at 0.3 micron particle size, including hand-held vacuums and wet-vacuums.
  - b. All vacuum devices exhausting air outside the facility shall be equipped with particulate collection including adequate filtration to contain debris removed from the HVAC system. Such devices shall exhaust in a manner that will not allow contaminants to re-enter the facility. Precautions shall be taken to locate the equipment down wind and away from all air intakes and other points of entry into the building. Release of debris outdoors must not violate any outdoor environmental standards, codes or regulations.

N. Containment

1. Debris removed during cleaning shall be collected and precautions must be taken to ensure that debris is not otherwise dispersed outside the HVAC system during the cleaning process.

O. Component Cleaning

1. All existing ductwork must be cleaned in accordance with NADCA Standard ACR. Cleaning methods shall be employed such that all included HVAC system components

must be visibly clean as defined in the Standard.

2. Air Duct Systems: The HVAC system cleaning contractor shall:
  - a. Clean air ducts to remove all non-adhered substances so that they are capable of passing NADCA cleanliness verification tests.
  - b. Access air ducts through service openings in the system that are large enough to accommodate mechanical cleaning procedures and allow for cleanliness verification.
  - c. Use mechanical agitation methods to remove particulate, debris, and surface contamination.
  - d. Capture dislodged substances with a vacuum collection device.
  - e. Not use any cleaning methods that will damage any HVAC components.
  - f. Mark the position of dampers and any air-directional mechanical devices inside the HVAC system prior to cleaning and, upon completion, restore them to their marked position.
  - g. Verify cleanliness after cleaning has been performed as described in NADCA Standard ACR.
- P. Cleanliness Verification
  1. All components within the project scope of work shall achieve, at minimum, the level of visibly clean or the specified method of cleanliness verification defined in the contractual documents. Cleanliness verification shall be performed on specified components as described in NADCA Standard ACR.
    - a. Cleanliness verification will be performed immediately after HVAC system component cleaning and prior to use in operation.
    - b. Cleanliness verification will be determined after mechanical cleaning and before the application of any treatment or introduction of any treatment-related substance to the HVAC system, including biocidal agents and coatings.
- Q. Disposal of Debris & Contaminated Materials
  1. All debris removed from the HVAC system shall be disposed of in accordance with applicable federal, state, provincial and local requirements. To prevent cross-contamination, all contaminated materials removed from the HVAC system shall be properly contained prior to removal from the building. Materials deemed to be hazardous by governmental agencies shall be handled in strict accordance with any applicable local, regional or national codes.
- R. Visual Inspection
  1. Visual inspection of porous and non-porous HVAC system components shall be conducted to assess that the HVAC system is visibly clean as defined in NADCA Standard ACR. If no contaminants are evident through visual inspection, the HVAC system shall be considered clean.
  2. If visible contaminants are evident through visual inspection, those portions of the system where contaminants are visible shall be re-cleaned and subjected to re-inspection for cleanliness.
- S. System Startup
  1. Install closures over services access openings before allowing system restart for normal facility operation.
  2. When system is placed in operation, remove temporary filter elements after minimum 24 hours operation.
- T. Post-Project Documentation
  1. At the conclusion of the project, if specified in the contract, the HVAC system cleaning

- contractor shall provide documentation showing compliance with this specification for all work performed. This documentation may include the following:
- a. Success of the cleaning project, as verified through visual inspection and/or cleanliness verification.
  - b. Photo images, HVAC plans and other supporting documents such as submittal forms for materials used and/or warranties or guarantees.
  - c. System areas found to be damaged and/or in need of repair.
2. The contractor shall provide a quality assurance certificate and guaranty, certifying that the system has been cleaned to the NADCA standard and guaranteeing the work for two years. Final approval shall be given after all specifications have been met and a project report containing all the above elements has been submitted to and approved by the owner. All cleaning will be verified in accordance with the National Air Duct Cleaners Association's standard test for cleanliness.

### 3.12 CONTRACTOR RESPONSIBILITIES FOR TEST & BALANCE

- A. Provide T&B agency one complete set of contract documents, change orders, and approved submittals in digital and hard copy formats. Project Schedule and Mechanical Contractor's Shop Drawings and Temperature Control Drawings shall be provided as issued or received.
- B. Controls Contractor shall provide required BAS hardware, software, personnel and assistance to T&B agency as required to balance the systems. Controls Contractor shall also provide trending report to demonstrate that systems are complete.
- C. Coordinate meetings and assistance from suppliers and contractors as required by T&B agency.
- D. Provide additional valves, dampers, sheaves and belts to properly test and balance, which shall be installed by the Mechanical Contractor as directed by T&B agency, at no additional cost to owner.
- E. Mechanical Contractor shall install test holes where indicated by the T&B Agency. Test holes shall be complete with removable and replaceable plugs
- F. Flag all manual volume dampers with fluorescent or other high-visibility tape.
- G. Provide access to all dampers, valves, test ports, nameplates and other appurtenances as required by T&B agency.
- H. Replace or repair insulation as required by T&B agency.
- I. Have the HVAC systems at complete operational readiness for T&B to begin. As a minimum verify the following:
  1. Airside:
    - a. All ductwork is complete with all terminals installed.
    - b. All volume, smoke and fire dampers are open and functional.
    - c. Clean filters are installed.
    - d. All fans are operating, free of vibration, and rotating in correct direction.
    - e. VFD start-up is complete and all safeties are verified.
    - f. System readiness checklists are completed and returned to T&B agency.
- J. Promptly correct deficiencies identified during T&B.
- K. Maintain a construction schedule that allows the T&B agency to complete work prior to occupancy.
- L. Before testing or balancing is started, the Mechanical Contractor shall adjust belts and sheaves; align all parts; oil and grease bearings in accordance with manufacturer's instructions; clean exterior surfaces of coil tubes and fins; flush interior of coil tubes, pull until clean; and check



mixing damper operation to insure free operation and activation by the correct thermostat

- M. The Mechanical Contractor shall be responsible for certifying in writing that the system, as scheduled for balancing, is operational and complete. Completeness shall include not only the physical installation, but the Mechanical Contractor's certification that the prime movers are installed in good working order, and that full load performance has been preliminary tested under the certification of the Mechanical Contractor. Before any testing and balancing is started, a complete report shall be sent to the T&B Agency by the Mechanical Contractor.
- N. The Mechanical Contractor shall be responsible for making all modifications to rectify discrepancies reported by the T&B Contractor as indicating non-compliance with the Contract Documents. By completing the work on time, the Mechanical Contractor shall provide sufficient time before the completion date so that balancing can be accomplished.

### **3.13 CLEANUP**

- A. Upon completion of the work of this Section, remove all material, debris, and equipment associated with or used in the performance of this Work.

**END OF SECTION**

## SECTION 23 0500

### GENERAL MECHANICAL

#### PART 1 GENERAL

##### 1.01 SUMMARY

- A. The General Conditions, Supplemental Conditions, and the requirements of this Section apply to all work of Division 23.

##### 1.02 QUALITY ASSURANCE

- A. Regulatory compliance: All work performed under Division 23 shall comply with the latest currently adopted editions of all codes and regulations and all requirements of all Authorities having Jurisdiction. The following references and standards are hereby made a part of these sections and work shall conform to applicable requirements herein, except as otherwise specified herein or shown on the Drawings.
- B. Codes, Standards: Conform to all applicable codes and standards as stated herein and as described in Division 01 of the Specifications, including the following:
  - 1. American Gas Association (AGA)
  - 2. American National Standards Institute (ANSI)
  - 3. American Society of Mechanical Engineers (ASME)
  - 4. American Society of Heating, Refrigerating and Air Conditioning Engineers (ASHRAE) Standards 55 and 62.1
  - 5. American Society for Testing and Materials (ASTM)
  - 6. California Building Code (CBC)
  - 7. California Code of Regulations Titles 8, 17, 19, 20, 21 & 22
  - 8. California Electric Code (CEC)
  - 9. California Energy Conservation Code (Title 24)
  - 10. California Fire Code (CFC)
  - 11. California Mechanical Code (CMC)
  - 12. CAL Green Building Standards
  - 13. California Occupational Safety & Health Administration (CAL-OSHA)
  - 14. California Plumbing Code (CPC)
  - 15. City Fire Marshal requirements
  - 16. National Electrical Manufacturers Association (NEMA)
  - 17. National Fire Protection Association (NFPA)
  - 18. NSF/ANSI 61 Standard, Drinking Water System Components - Health Effects for fixture materials that will be in contact with potable water.
  - 19. Office of Statewide Health Planning and Development (OSHPD)
  - 20. Sheet Metal and Air Conditioning Contractors Nation Association (SMACNA) Standards
  - 21. Underwriters Laboratories (UL)
- C. Minimum requirements: The requirements of these are the minimum that will be allowed unless such requirements are exceeded by applicable codes or regulations, in which the regulatory codes or regulation requirements shall govern.
- D. When the Contract Documents call for materials or construction of a higher standard than is required by the above, the Contract Document requirements shall take precedence over the requirements of the said laws, rules, and/or regulations, accepting that nothing in the Contract Documents shall be interpreted as permitting work in violation of said laws, rules, and/or regulations. The Contractor for this work shall furnish any additional materials and/or labor as

may be required for compliance with these laws, rules, and/or regulations though such materials and/or labor are not specifically set forth in the Contract Documents, with no additional charges to Owner.

- E. Seismic construction and restraints shall be in accordance with the requirements of Title 24 of the California Code of Regulations. All equipment mounts, isolators, and hanging systems must meet local authority approval requirements.
- F. Comply with the Safety Orders issued by Cal-OSHA and any other regulations of the State of California and any districts having jurisdictional authority.

### **1.03 LICENSES, PERMITS, FEES**

- A. The Contractors for this Section of work shall provide, procure and pay for all licenses, permits, fees, etc. as required to carry on and complete their work.

### **1.04 LICENSING REQUIREMENTS**

- A. All work of Divisions 23 shall be performed by an appropriately licensed contractor. The licenses shall be current, valid through the term of the contract and in the name of the contractor.
  - 1. All HVAC work, which includes warm air heating systems and water heating pumps, ventilating systems, air conditioning systems, and ductwork, registers, flues, humidity, and thermostatic controls in connection with these systems, shall be performed by a C-20 - Warm-Air Heating, Ventilating and Air-Conditioning Contractor.
  - 2. All air and/or water balancing shall be performed by a D-62 air and water balancing contractor. An air and water balancing contractor installs any device and performs any work related to providing a specified flow of air in all types of existing heating and cooling systems and/or related to providing a specified flow of water in water piping systems.

### **1.05 CONTRACT DRAWINGS**

- A. The Contract Drawings indicate diagrammatically the general layout of the mechanical systems and other related work. Field verification of scaled dimensions taken from the Drawings is required.
- B. Contractor shall review and compare the Architectural, Structural, Plumbing, Mechanical and Electrical Drawings and all Owner supplied equipment Drawings and adjust their work to be in conformity with the conditions indicated thereon. Discrepancies between different Drawings, between Drawings and actual field conditions, or between Drawings and Specifications, shall be brought to the attention of the Architect promptly for a determination of the modifications to be affected.

### **1.06 SUBMITTALS**

- A. General:
  - 1. All submittals shall be in accordance with the requirements of the General Conditions and Division 01 Sections for Submittal Procedures and Product Requirements.
  - 2. Before any fixtures, materials, or equipment are purchased, the Contractor shall submit to the Architect for approval, a complete list of materials, fixtures, and equipment, giving the manufacturers' names, catalog number, capacity, size, power requirements, and other pertinent data. Submittal lists and drawings shall be specifically applicable to this project, shall include identifying marks assigned by Specifications and Drawings, and shall not contain extraneous material or optional choices.

3. The Contractor shall submit for the approval of the Architect, shop drawings of proposed material and equipment that differ from the specified materials and equipment, and of any specified materials and equipment with special conditions and/or arrangements. These drawings shall show necessary modifications of Owner, plumbing, electrical and mechanical work required by the proposed materials and equipment.
4. Submittal of substitutions shall be limited to one proposal for each type or kind of item. If the first proposed product submittal is rejected, the Contractor shall then submit the first named or scheduled product.
5. Contractor shall make all necessary field measurements and investigations to assure that the equipment and assemblies will meet contract requirements. Review of drawings and other material submitted shall not be construed as a complete check or constitute a waiver of the requirements of the Drawings and Specifications, but will indicate that the material submitted is acceptable in quality and utility. This review shall not relieve the Contractor of the responsibility to fit the proposed materials to the spaces provided, and to effect necessary rearrangement or construction of other work.

#### **1.07 WARRANTIES**

- A. In accordance with Division 01 and as follows.
  1. Warranty all materials, equipment, apparatus and workmanship to be free from defects and faulty workmanship for the period specified in General Conditions and Section 01 7000.
  2. Provide new materials, equipment, apparatus and labor to replace that determined to be defective or faulty.
  3. Furnish Manufacturer's standard warranties for all equipment, with all necessary information filled in except purchase date, in favor of the Owner

#### **1.08 DELIVERY, STORAGE, AND HANDLING**

- A. Contractor shall be responsible for delivery, storage, protection and placing of all equipment and materials.
- B. Contractor shall protect the work and materials from damage during construction. Equipment stored at the jobsite shall be protected from dust, water or other damage, and be covered if equipment is exposed to weather. Protect interiors of new equipment and piping systems against entry of foreign matter. Clean both inside and outside before painting or placing equipment in operation.
- C. Any items damaged shall be repaired or replaced, at no additional cost to the Owner.
- D. Cleanliness of Piping and Equipment Systems:
  1. Exercise care in storage and handling of equipment and piping material to be incorporated in the work. Remove debris arising from cutting, threading and welding of piping.
  2. Piping systems shall be flushed, blown or pigged as necessary to deliver clean systems.
  3. Contractor shall be fully responsible for all costs, damage, and delay arising from failure to provide clean systems.

#### **1.09 COOPERATION WITH OTHER TRADES**

- A. Cooperate fully with other trades doing work on the project as may be necessary for the proper completion of the project. Refer to the Structural, Plumbing, and Electrical Drawings for details of the building structure and equipment installation that will tend to overlap, conflict with, or require coordination with the work of this Section, and schedule this work accordingly.

- B. Priority of right of way in space shall be as follows, in decreasing order of authority:
  - 1. Electrical lights, electrical panels and drain piping.
  - 2. Ductwork.
  - 3. Fire protection piping, domestic hot water, domestic cold water and condenser water piping.
- C. Any work done without regard for other trades shall be moved, replaced, or redone as required, without extra charges to Owner.

#### **1.10 ACCURACY OF DATA**

- A. The data given herein and on the Drawings is as exact as could be reasonably secured, but absolute accuracy is not guaranteed. Exact locations, distances, elevations, etc. will be governed by shop drawings, the building itself, and actual field conditions.

#### **1.11 UTILITY CONNECTIONS**

- A. Arrange for all utility connections, determine their exact requirements, and pay all costs incurred.
- B. Send proper notices, make necessary arrangements, and perform other services required for care and maintenance of all utilities and assume all responsibility concerning same. Observe all rules and regulations of the respective utilities in executing the work.

#### **1.12 DAMAGE BY LEAKS**

- A. Contractor shall be responsible for any damage to work of other Contractors that is caused by leaks in any temporary or permanent piping systems due to pipe rupture, disconnected pipes or fittings, or by overflow of equipment.
- B. Patching and replacing of damaged work shall be done by the Contractor who installed the work, as directed by the Architect, but the cost of same shall be paid by the Contractor who is responsible for the damage.

### **PART 2 PRODUCTS**

#### **2.01 PRODUCTS CRITERIA**

- A. All materials, appliances, and equipment shall be new and best of their respective kinds, free from defects, and of the make, brand or quality specified or as accepted by the Architect.
- B. Multiple Units: When two or more units of materials or equipment of the same type or class are required, these units shall be products of one manufacturer.
- C. Apply and install all items in accordance with the manufacturer's written instructions. Refer conflicts between the manufacturer's instructions and the contract drawings and specifications to the Architect for resolution.
- D. All fixtures, materials, and equipment equal in quality and utility to those herein mentioned will be accepted. When specific names are used in describing fixtures, materials, and equipment they are mentioned as standards only, but this implies no right on the part of the Contractor to use other fixtures, materials and equipment, or methods, unless approved as equal in quality and utility by the Architect. The decision of the Architect shall govern as to what fixtures, materials, and equipment are equals to those mentioned, but the burden of proof as to the quality of any proposed fixtures, materials, or equipment shall be upon the Contractor. If any tests are necessary to determine the quality of proposed fixtures, materials, or equipment,

an unbiased laboratory satisfactory to the Architect shall make such tests at the expense of the Contractor .

## 2.02 GENERAL

- A. Provide guards to enclose exposed moving equipment components in accordance with Title 8, California Administrative Code. Fabricate belt guards with rigid angle iron frame, expanded metal screen, pivoted 4" diameter tachometer opening covers, and in two pieces to permit lubrication or sheave and belt adjustment without removing guard. Provide removable sheet metal guards at shafts and couplings and removable framed wire mesh guards at openings in mechanical systems.

## 2.03 HANGERS, SUPPORTS

- A. All piping shall be supported with Superstrut, B-Line, Anvil, Mifab, or approved equal pipe hangers and supports. Select size of hangers and supports to exactly fit pipe size for bare piping, and to exactly fit around piping insulation with shield for insulated piping.
- B. Hangers and supports shall be designed and manufactured in conformance with ANSI/MSS SP-58. Selection and application shall be in accordance with ANSI/MSS SP-69.
- C. All hangers shall be electro-chromate or corrosion resistant finished. Hanger rods shall have electro-galvanized finish.
- D. Roof top pipe supports
  - 1. MiFab "C-Port" series or B-Line "Dura-Block" or approved equal.
    - a. Model C rubber support series with 14-gauge galvanized channel.
    - b. Seismic: Model CZ rubber base with 14-gauge galvanized channel
- E. Seismic hanger rod stiffeners: B-Line SC-228, Anvil AS 3500 or approved equal
- F. Copper tubing:
  - 1. B-Line 3690, Superstrut C-711 or Anvil Figure 67 "J" pipe hangers or approved equal, complete with isolator.
  - 2. Isolators: B-Line "Vibra Cushion" B1999, Type L & K for copper tubing, Superstrut C-716 isolator for copper, Anvil Figure CT-769 or approved equal
- G. Insulated pipe:
  - 1. Hangers: B-Line 3690 "J" pipe hanger, Superstrut C -711 or Anvil Figure 67 fitted to outside of insulation or approved equal
  - 2. Pipe Shields: B-Line 3151 insulation protection shield, Superstrut C-790, or Anvil Figure 167 or approved equal
- H. Channel: B-Line B22, Superstrut A 1200, Anvil AS 200 or approved equal.
- I. Trapeze hangers: Grouped pipes may be supported by channel bolted to rods.
- J. Point of support connectors:
  - 1. Wood construction:
    - a. Stationary pipes: B-Line B3060, Superstrut 540 or Anvil Figure 206 side beam hanger clip or approved equal
    - b. Pipes subject to movement: B-Line B-756 or Superstrut S-541 beam clamp swing connector or approved equal
  - 2. New concrete construction: B-Line B2501 light duty spot inserts or Superstrut 452-TB spot inserts or approved equal.
  - 3. Existing concrete construction: Phillips "Red-Head" 3-piece concrete anchors or Hilti

- “Quik-Bolt”, drilled-in, concrete anchors.
4. Steel beams: Superstrut Series 500 beam brackets or equal.
  5. Plywood decks: machine bolts, nuts and washers.
- K. Vertical pipe risers:
1. Riser clamps: Superstrut C-720 extension riser clamps anchored to construction
    - a. Bare cold- water pipe: Superstrut C-720P, PVC coated to prevent corrosion.
- L. Ductwork
1. Hanger Rods for Noncorrosive Environments: Cadmium-plated steel rods and nuts.
  2. Hanger Rods for Corrosive Environments: Electrogalvanized, all-thread rods or galvanized rods with threads painted with zinc-chromate primer after installation.
  3. Strap and Rod Sizes: Comply with SMACNA's "HVAC Duct Construction Standards - Metal and Flexible," Table 5-1, "Rectangular Duct Hangers Minimum Size," and Table 5-2, "Minimum Hanger Sizes for Round Duct."
  4. Steel Cable End Connections: Cadmium-plated steel assemblies with brackets, swivel, and bolts designed for duct hanger service; with an automatic-locking and clamping device.
  5. Duct Attachments: Sheet metal screws, blind rivets, or self-tapping metal screws; compatible with duct materials.
  6. Trapeze and Riser Supports:
    - a. Supports for Galvanized-Steel Ducts: Galvanized-steel shapes and plates.
    - b. Supports for Stainless-Steel Ducts: Stainless-steel shapes and plates.
    - c. Supports for Aluminum Ducts: Aluminum or galvanized steel coated with zinc chromate.

## 2.04 PIPE LABELS

- A. Brady, Seton or approved equal pipe labels. Preprinted, color-coded, with lettering indicating service, and showing flow direction.
- B. Self-Adhesive Pipe Labels: Printed plastic with contact-type, permanent-adhesive backing.
- C. Pipe Label Contents: Include identification of piping service using same designations or abbreviations as used on Drawings, pipe size, and an arrow indicating flow direction.
- D. Flow-Direction Arrows: Integral with piping system service lettering to accommodate both directions, or as separate unit on each pipe label to indicate flow direction.
- E. Label Sizes (per ANSI A13.1 / ASME A13.1-2015 Standards):
  1. For pipes or covering with outside diameter  $\frac{3}{4}$  to  $1\frac{1}{4}$  inches, minimum length of label: 8 inches, minimum height of letters:  $\frac{1}{2}$  inch.
  2. For pipes or covering with outside diameter  $1\frac{1}{2}$  to 2 inches, minimum length of label: 8 inches, minimum height of letters:  $\frac{3}{4}$  inch.
  3. For pipes or covering with outside diameter  $2\frac{1}{2}$  to 6 inches, minimum length of label: 12 inches, minimum height of letters:  $1\frac{1}{4}$  inch.

## 2.05 ELECTRICAL MOTORS

- A. With exception of motors in UL labeled equipment, motors for HVAC blowers and fans, pumps, and other general purpose applications using an adjustable speed drive shall be Baldor Premium Efficient Super-E®, three phase, foot mounted, Class H insulated motor with AEGIS shaft grounding ring installed internally, re-greasable ball bearings, dynamically balanced rotors.
- B. Motors shall be certified for quiet operation and shall bear a label so stating. Motors shall be

drip-proof frame, 1.15 minimum service factor in 40°C, ambient windings specially impregnated and epoxy coated for outdoor service.

- C. Torque characteristics of motors shall be as required to accelerate machine to 100% full load speed within 10 seconds. Motors shall be dynamically balanced to maximum deflection as follows:
  - 1. 15 HP and larger: 0.0003 inches.
  - 2. 10 HP and smaller: 0.0002 inches.
- D. Motors shall be Inverter duty, meet NEMA MG-1 and part 30 and 31, and shall be guaranteed to satisfactorily operate at  $\pm 10\%$  voltage shown on Drawings. Transformers of adequate capacity shall be provided if necessary, to satisfy this requirement.
- E. All 3-phase motors shall be provided with phase and brown-out protection to shut down all motors in the unit if the phases are more than 10% out of balance on voltage or the voltage is more than 10% under design voltage.
- F. Fractional horsepower fan motors ( $\frac{1}{4}$  hp,  $\frac{1}{2}$  hp,  $\frac{3}{4}$  hp) shall be Greenheck "Vari-Green" series motors, DC electronic commutation type, specifically designed for fan applications. Motors shall be permanently lubricated with heavy duty ball bearings to match the fan load and pre-wired to the specific voltage and phase. Internal motor circuitry shall convert AC power supplied to the fan to DC power to operate the motor. Motor shall be controllable down to 20% of full speed (80% turndown). Speed shall be controlled by either a potentiometer dial mounted at the motor or by a 0-10 VDC signal. Motor shall be a minimum of 85% efficient at all speeds.
- G. Provide fan drives rated at 150% of motor horsepower. Drives shall be adjustable sheave type unless specified otherwise. Listed fan speeds are only approximate; select and/or change drives to operate at approximately midpoint of adjustable range after final balancing.

### **PART 3 EXECUTION**

#### **3.01 INSTALLATION, GENERAL**

- A. Provide all necessary sleeving, core drilling, carpentry, cutting and patching required for proper installation of material and equipment specified.
- B. No structural members shall be drilled, bored, or notched in a manner that will impair their structural capacity. No structural cutting or drilling shall be done without the approval of the Architect.
- C. All penetrations of concrete or masonry shall be made with core drills. Verify location of all core drills with structural engineer prior to execution.

#### **3.02 VERIFICATION OF EXISTING CONDITIONS AND DEMOLITION**

- A. Before installation of any new work, verify the location, size and other conditions at all points of connection to services or other existing piping, and at all locations where new work will cross or pass near existing piping, electrical, or other facilities.
- B. Information shown relative to existing services is based upon available records and data during preparation of the Drawings but shall be verified. Make reasonable deviations found necessary to conform with actual locations and conditions, without extra charge.
- C. Remove piping, controls, fixtures, and equipment that is not to remain in service as shown on the Drawings or as required. This includes the removal of associated appurtenances and supports.



- D. Patch, cap, or repair existing works affected by this demolition in concealed spaces within 6" of a live main or branch.
- E. Deliver removed material to the Owner as directed by the Architect. Dispose of all other removed material offsite.

### **3.03 EQUIPMENT**

- A. Equipment shall operate quietly and without objectionable vibration. Such problems, other than from equipment operating at optimum conditions, shall be the Contractor's responsibility and shall be eliminated at the direction of the Architect.
- B. Install equipment to provide good appearance, easy access, and adequate space to allow replacement and maintenance. Provide bases, supports, anchor bolts, and other items required to achieve this. Installation shall be level, above moisture level, and adequately braced.
- C. Extend ¼" schedule 40 black steel lubrication pipes from hard-to-reach locations to front of equipment or to access doors. Terminate with proper lubrication fittings.
- D. Move equipment into building through available openings. Dismantle equipment where necessary to accomplish this. After reassembly, test equipment to verify its satisfactory operating condition.
- E. Thoroughly lubricate equipment before operating. Repair of damage resulting from failure to comply with this requirement shall be the Contractor's responsibility.
- F. Connections to piping shall be secured and properly aligned and all utility and control connections shall be properly isolated from the building structure by means of vibration isolators and flexible connections. Any equipment not meeting this requirement will be modified and properly reinstalled at no expense to the Owner.

### **3.04 ACCESS**

- A. All items that require access, such as for operating, cleaning, servicing, maintenance, and calibration shall be easily and safely accessible by persons standing at floor level, or standing on permanent platforms, without the use of portable ladders. Examples of these items include but are not limited to: all types of valves, filters and strainers, transmitters and control devices. Prior to commencing installation work, refer conflicts between this requirement and contract Drawings to Architect for resolution.

### **3.05 MECHANICAL SERVICES**

- A. Terminals and services weighing no more than 20 pounds, may be supported directly on the runners of a heavy-duty grid system but, in addition, they must have a minimum of (2) #12-gauge slack safety wires attached at diagonally opposite corners and anchored to the structure above.

### **3.06 CONCRETE EQUIPMENT BASES**

- A. Concrete work that is part of the mechanical installations, as such is shown and/or detailed on the Drawings, shall conform to the requirements of the Concrete Section of these Specifications.
- B. Concrete bases: Anchor equipment to concrete base according to equipment details on mechanical and structural Drawings.
- C. Bases shall be neatly finished, have rounded corners and smooth trowel finish.

### 3.07 ELECTRICAL REQUIREMENTS

- A. Electrical work in this Section shall conform to the requirements of Division 26. Equipment shall conform to the standards of the National Electric Manufacturer's Association. Electrical equipment shall bear the label of Underwriters' Laboratories, Inc., where examination and listing service is available for such materials. Motors and motor control equipment shall be as specified below.
  - 1. The work shall include the furnishing of:
    - a. Motor controls mounted as integral part of equipment assemblies.
    - b. Pre-wired control panels as described and shown.
    - c. Electronic control panels and their components.
    - d. Wiring for low voltage controls and "interlock work" except where specifically shown otherwise.
  - 2. Installing of:
    - a. All motors.
    - b. All control panels and their components.
    - c. Low voltage wiring, line voltage "interlock" wiring, control wiring for safety devices, alarms, and refrigeration.
- B. Wiring includes all connections to devices, and all wiring shall be installed in conduit.
  - 1. Conduit fittings and devices shall be as specified in the basic electrical materials section of Division 26 - Electrical.
  - 2. Line voltage work (in equipment assemblies) shall be as specified in Division 26 - Electrical.
  - 3. Devices shall be installed in NEMA enclosures of type required for location.
- C. Electrical Controls:
  - 1. Submit shop-wiring diagrams of temperature controls and air conditioning unit controls for approval. Furnish approved wiring diagrams and assistance to Electrician.
  - 2. Refer to Electrical, Fire Protection, Plumbing and Mechanical documents for work and devices required. All wiring required by plumbing and heating, ventilating and air conditioning work shall be performed by the Controls Contractor.
- D. The following work will be furnished and installed under Division 26.
  - 1. Disconnect switches, remote switches, motor starters, relays and test switches not mounted as integral part of equipment assemblies or in temperature control panels.
  - 2. All line voltage controls and interlocks, all other controls, circuits from electric panel board to disconnect switches, starters, motors, switches and/or other motor controls, to temperature controls and safety devices.

### 3.08 PAINTING

- A. Properly prepare work to be painted per the requirements of Division 09, except preservative and special painting as described herein. Priming shall conform to Division 09 requirements and be of a material compatible with paint for finish painting.
- B. Priming, as required, shall conform to the Painting section requirements and be of a material compatible with paint for finish painting.
- C. All equipment and materials shall be cleaned of grease, wax, oil, rust or dirt in preparation for finish painting. Any prime coated surfaces showing signs of rust before being finish painted shall be thoroughly cleaned and a new prime coat applied.
- D. Equipment in equipment rooms and like spaces, shall be furnished with a factory applied baked prime coat or at Contractor's option, a standard factory baked enamel finish in approved colors.

Machinery such as fans, or motors shall be furnished with a factory applied baked on prime coat, or at the Contractor's option, a standard paint finish (air dried or baked enamel) in approved colors. Mechanical equipment in other locations shall be furnished with a factory applied baked prime coat, unless noted otherwise.

- E. Paint interior of ductwork at air outlets with one coat of flat black paint.
- F. Prime paint both sides of flashings prior to installation.
- G. Furnish can of touch up paint with each factory finished piece of equipment.
- H. Paint all piping in mechanical rooms. Color as selected by the Architect.
- I. Black steel piping exposed to the environment shall be painted with rust-inhibiting paint. Color as selected by Architect.

### 3.09 IDENTIFICATION OF SYSTEMS

- A. Nameplates
  - 1. Nameplate bearing manufacturer's name or identifiable trademark shall be securely affixed in a conspicuous place on equipment, or name or trademark cast integrally with equipment, stamped or otherwise permanently marked on each item of equipment.
- B. Piping
  - 1. All piping shall be identified. Attach arrows at one or both ends of the marker to indicate flow direction
  - 2. If the pipe being labeled contains multiple hazards, determine which has the greatest hazardous risk and label accordingly.
  - 3. Locate pipe labels where piping is exposed or above accessible ceilings in finished spaces, machine rooms, accessible maintenance spaces such as shafts, tunnels, and plenums, and exterior exposed locations as follows:
    - a. Adjacent to all valves and flanges
    - b. Near each branch connection, excluding short takeoffs for fixtures and terminal units. Where flow pattern is not obvious, mark each pipe at branch.
    - c. At both sides of wall or floor penetrations.
    - d. Before and after all wall, floor and ceiling penetrations and inaccessible enclosures.
    - e. Adjacent to changes in direction.
    - f. At access doors, manholes, and similar access points that permit view of concealed piping.
    - g. Near major equipment items and other points of origination and termination.
    - h. Spaced at maximum intervals of 25 feet along each run. Reduce intervals in areas of congested piping and equipment.
    - i. On piping above removable acoustical ceilings. Omit intermediately spaced labels.
  - 4. Pipe Label Color Schedule: (per ANSI A13.1 / ASME A13.1)
    - a. Potable, Cooling, Boiler Feed and other Water Piping:
      - 1) Background Color: Green.
      - 2) Letter Color: White.
    - b. Fire Quenching Fluids:
      - 1) Background Color: Red.
      - 2) Letter Color: White.
    - c. Toxic and Corrosive Fluids
      - 1) Background Color: Orange.
      - 2) Letter Color: Black
    - d. Flammable Fluids:
      - 1) Background Color: Yellow.

- 2) Letter Color: Black.
  - e. Combustible Fluids:
    - 1) Background Color: Brown.
    - 2) Letter Color: White
  - f. Compressed Air:
    - 1) Background Color: Blue.
    - 2) Letter Color: White.
- C. Valves
  - 1. For identification and Owner's maintenance records, all valves shall be numbered and identified with clearly stamped 1¼" diameter brass tags, in accordance with drawings and service performed.
  - 2. Control valves shall be also marked whether normally open (N.O.) or normally closed (N.S.).
  - 3. Affix Underwriter's standard porcelain enameled identification signs to all fire protection sprinkler control valves, drain valves, and flow switches.
- D. Equipment
  - 1. All equipment shall be labeled with 1" high stencils showing identifying mark noted on drawings, and usage.
  - 2. Warning signs shall be placed on machines driven by electrical motors that are controlled by fully automatic starters, per California Code of Regulations, Title 8, Subchapter 7 - General Industry Safety Orders, Article 7, Section 3320.
- E. A typewritten schedule of all stencils and valve tags used, with identification, shall be framed and posted in mechanical rooms, at locations as directed.

### 3.10 SEISMIC FORCE RESISTANCE

- A. Piping:
  - 1. Flexibility of piping systems must be maintained by using flexible devices at critical points at junctions of separate building structures. Braces or anchors shall be designed to damp oscillations or check excessive movement. Flexible devices for piping of gas shall be loops or offsets. Flexible devices for other piping may be loops, Victaulic grooved, or roustabout couplings.
  - 2. Piping at tops and bottoms of risers are critical points where flexibility is required, as well as at changes in direction on long runs of piping 4" and larger. Tops of risers shall be restrained from motion in horizontal direction, and midpoints shall be anchored in all directions.
  - 3. Sway bracing shall be installed at intervals of 30 to 40 feet on pipe runs to prevent excessive lateral motion. Bracing shall be designed to resist a force equal to 100% of the weight of piping system and contents, applied in any direction.
  - 4. In design of the braces, the slenderness ratio  $l/r$ , shall not exceed 200 where "l" is the effective length of the brace and "r" is the least radius of gyration, both in inches. The following table shows maximum lengths of shapes used for sway bracing:

TYPE/SIZE	MAX. LENGTH ( $l/r=200$ )	TYPE/SIZE	MAX. LENGTH ( $l/r=200$ )
Angle		Flat Bar	
1½ x 1½ x ¼"	4'-10"	1½ x ¼"	1'-2"
2 x 2 x ¼"	6'-6"	2 x ¼"	1'-2"
2½ x 2½ x ¼"	8'-2"	2 x ⅜"	1'-9"
3 x 3 x ¼"	9'-10"		

Threaded Rod		Pipe (Schedule 40)	
3/8"	1'-7"	1"	7'-0"
1/2"	2'-1"	1 1/4"	9'-0"
5/8"	2'-7"	1 1/2"	10'-4"
3/4"	3'-1"	2"	13'-1"
1"	4'-2"		

### 3.11 INSTALLATION - HANGERS AND SUPPORTS, PIPING

- A. Pipe supports shall be spaced according to CMC 2019, Table 313.3 and sufficiently close to support pipes properly without formation of pockets. Hangers shall be installed at ends of mains and branches.
- B. Refrigerant piping shall be supported per CMC 1109.6.
- C. Install hangers and supports complete with necessary attachments, inserts, bolts, rods, nuts, washers, and other accessories.
- D. No valve or piece of equipment shall be used to support piping.
- E. Install hangers and supports to allow controlled thermal and seismic movement of piping systems, to permit freedom of movement between pipe anchors, and to facilitate action of expansion joints, expansion loops, expansion bends, and similar units.
- F. Flexibility of piping systems must be maintained by the use of flexible devices at critical points at junctions of separate building structures. Braces or anchors shall be designed to damp oscillations or check excessive movement. Flexible devices for piping of gas shall be loops or offsets. Flexible devices for other piping may be loops, Victaulic grooved, or roustabout couplings.
- G. Piping at tops and bottoms of risers are critical points where flexibility is required, as well as at changes in direction on long runs of piping 4" and larger.
- H. Tops of risers shall be restrained from motion in horizontal direction, and midpoints shall be anchored in all directions.
- I. Install lateral bracing with pipe hangers and supports to prevent swaying.
- J. Install building attachments within concrete slabs or attach to structural steel. Install additional attachments at concentrated loads, including valves, flanges, and strainers, 2-1/2 inches and larger and at changes in direction of piping. Install concrete inserts before concrete is placed; fasten inserts to forms and install reinforcing bars through openings at top of inserts.
- K. Metal Pipe-hanger Installation: Install hangers, supports, clamps, and attachments as required to properly support piping from the building structure.
- L. Metal Trapeze Pipe-Hanger Installation: Support together and space trapezes for smallest pipe size or install intermediate supports for smaller diameter pipes as specified for individual pipe hangers.
- M. Thermal-Hanger Shield Installation: Install in pipe hanger or shield for insulated piping.
- N. Load Distribution: Install hangers and supports so that piping live and dead loads and stresses from movement will not be transmitted to connected equipment.
- O. Insulated Piping:

1. Attach clamps and spacers to piping.
  - a. Piping Operating above Ambient Air Temperature: Clamp may project through insulation.
  - b. Piping Operating below Ambient Air Temperature: Use thermal-hanger shield insert with clamp sized to match OD of insert.
  - c. Do not exceed pipe stress limits allowed by ASME B31.9 for building services piping.
- P. Ductwork
  1. Comply with SMACNA's "HVAC Duct Construction Standards - Metal and Flexible," Chapter 5, "Hangers and Supports."
  2. Support vertical ducts with steel angles or channel secured to the sides of the duct with welds, bolts, sheet metal screws, or blind rivets; support at each floor and at maximum intervals of 16 feet.
  3. Install upper attachments to structures. Select and size upper attachments with pull-out, tension, and shear capacities appropriate for supported loads and building materials where used.

### 3.12 PIPE WELDING

- A. All hot and chilled water, steam and steam condensate, compressed air and vacuum piping shall be installed, examined, inspected and tested in accordance with the requirements of ASME B31.9, Building Services Piping, current edition.
- B. Before any welding is performed, the contractor shall submit to the Architect, copies of any welding procedure specifications and their supporting procedure qualification records for review and acceptance. Copies of welder qualification records shall be made available for review to the owner or his representative at the construction site.
- C. Weld all pipe 2.5 inches and larger. Use the following procedure. All welders must be AWS certified. AWS B2.1 SMAW 6G Pipe Welding Procedure Specifications
  - Welding process: SMAW
  - Position: 6G Fixed position
  - Weld Progression: Up
  - Backing: No
  - Current/Polarity: DCEP
  - Root Opening: 1/16 to 1/8
  - Grove Angle: 60 degrees
  - Material/Spec: A 106
  - Thickness (pipe/tube): Groove (in) .280
  - Notes: Sch. 40 Pipe
  - Filler Metal Class: E6010Rt/E7018F1
  - Other Filler Metal Class: Rt. 1/8, 3/32 Filler
- D. Welded joints shall be beveled and butt-welded. Reductions of pipe shall be made with forged steel welding fittings. Branch reductions of two or more pipe sizes smaller than the main, may be Bonney "Weld-O-Let" fittings, or equal. Job fabricated reductions and branches shall not be used. All pipe burrs shall be reamed out. Welding rods shall be as follows, or approved equal:

<u>Pipe Size</u>	<u>Arc Welding</u>	<u>Gas Welding</u>
2" and larger	Fleetweld #5	Oxweld #1 or Page Hi-Test M
1½" and smaller	None	Oxweld #1 or Page Hi-Test M

### 3.13 INSTALLATION, PIPING

- A. Installation of piping shall be such that damage cannot result through thermal expansion or contraction, to piping, building, or pipe hangers and supports. Anchors shall be installed at midpoints of all runs in main piping for the purpose of localizing pipe expansion or prevention of creepage.
- B. Rough in shall proceed as rapidly as general construction will permit. All rough-in shall be

complete, at locations verified by Architect and Owner, and tested and inspected prior to installation of concrete, lath, plaster, gypsum wallboard, or other finishes.

- C. All piping shall be concealed in finished rooms, installed in furred walls and partitions. Where furred or suspended ceilings occur, piping shall be installed in the concealed space at points adjacent to beams and/or other structural members and coordinated with ductwork and equipment. Where exposed piping occurs, it shall be installed parallel to or at right angles to building walls, unless specifically shown otherwise on the Drawings.
- D. All pipe lines shall be installed free from traps and air pockets, true to line and grade, with suitable supports properly spaced. All piping shall be installed without undue stresses and with provision for expansion and contraction.
- E. All piping shall be new and free from foreign substances. American standard pipe threads shall be used for IPS threaded work. Joints in threaded piping shall be made up with Teflon tape applied to the male threads only. No screwed pipe joints shall be caulked or packed with rope or other packing materials. Pipe shall be free from tool marks, threads cut accurately with not more than two threads showing beyond fitting. Friction wrenches shall not be used with plated, polished, or soft metal piping. All changes in pipe size shall be made with reducing fitting. Bushings will not be permitted.
- F. Protect unattended openings in piping during construction.
- G. All copper tubing shall be formed in a workmanlike manner, in accordance with the Pipe and Tube Bending Handbook of the Copper and Brass Research Association. A tube bender giving support to the periphery of the tube shall be used. The tubing shall be protected against flattening or other injury.
- H. All copper connections and joints shall be made in accordance with the Copper Tube Handbook, Copper and Brass Research Association. No swaged connections will be permitted. All valves, pumps, and similar equipment shall be connected to copper piping through union or flange adapter fittings.
- I. No water or drainage piping shall pass over electrical equipment unless adequate protection is provided to prevent damage by leaks or condensation.
- J. Valves, cocks, etc., shall be installed to allow convenient accessibility and operation.
- K. Unions and flanges shall be installed to allow convenient replacement of all equipment and cleaning tubes.
- L. A union connection shall be installed downstream from all valves, at equipment connections and at other locations as required or directed.
- M. Shut off valves shall be provided in all main services, and where required to permit proper servicing of equipment. Valves of one type shall be of one manufacturer.
- N. All valves shall be of the same size as the pipelines in which they are installed, unless specifically sized on the Drawings. All hand-controlled line valves shall be ball valves, except where throttling control or frequent operation is required, in which case globe or angle valves shall be used. Globe valves in horizontal lines shall be installed with stem in horizontal to permit line draining. All globe and angle valves shall be installed to close against pressure. Disc valves shall have discs suitable for the services for which they are to be used.
- O. All valves shall be accessible and shall not be installed with the stems below the horizontal plane. Provide access panels at walls, ceilings, or floors.
- P. Provide chrome plated escutcheon plates at all points where exposed piping penetrates finished

wall ceilings or floors.

- Q. Cutting or boring of joists or other structural members shall be done only when alternative routing is impossible and only upon written approval of the Architect or Owner.

### **3.14 CLEANING OF PIPING**

- A. All new piping shall be thoroughly cleaned of rust, scale, etc., prior to enclosing and placing in operation. Water shall be forced through pipes until the systems are free from foreign substances.

**END OF SECTION**



**SECTION 23 0593**  
**TESTING, ADJUSTING, AND BALANCING FOR HVAC**

**PART 1 GENERAL**

**1.01 RELATED DOCUMENTS**

- A. Drawings and general provisions of the Contract, including General and Supplementary Conditions and Division 01 Specification Sections, apply to this Section.

**1.02 SUMMARY**

- A. Section Includes:
  - 1. Balancing Air Systems
  - 2. Additional Tests
    - a. Sound testing
    - b. Vibration testing
    - c. Duct leakage testing
    - d. Controls verification

**1.03 SCOPE**

- A. The T&B Agency will provide the following services:
  - 1. Provide all supervision, personnel, instruments, calibration equipment, and all other materials necessary to perform balancing and testing, and compile test data including calculations and services necessary for the heating, ventilating, and air conditioning systems for this project, all in accordance with the project Drawings and Specifications and as specified herein.
  - 2. The T&B Agency shall be responsible for inspecting, balancing, adjusting, testing, and logging the data of the performance of fans, all dampers in the duct systems, all air distribution devices or heat exchangers, and the flows of water through all coils.
  - 3. The T&B Agency shall balance, test, and adjust the systemic components to obtain optimum conditions in each conditioned space in the building. If construction deficiencies are encountered which preclude obtaining optimum conditions, the deficiencies will be recorded and given to the Owner's Representative. The T&B Agency is advised that deficiencies in the HVAC construction are often encountered during final T&B services and should include in the bid an amount deemed advisable to compensate for time in identifying the deficiencies.
- B. During construction, the T&B Contractor shall inspect the installation of pipe systems, sheet metal work, temperature controls, and other component parts of the HVAC systems. Inspections shall be conducted a minimum of three times. Typically, this is performed when 60% of the ductwork and piping are installed and again when 90% of the total system is installed and prior to insulation. A copy of the written report is to be issued to the Mechanical Engineer for review.

**1.04 SUBMITTALS**

- A. Strategies and Procedures Plan: Within 30 days of Contractor's Notice to Proceed, submit T&B strategies and step-by-step procedures.
- B. System Readiness Checklists: Within 30 days of Contractor's Notice to Proceed, submit system readiness checklists for use by systems installers in verifying system readiness for T&B.

Examination Report: Within 30 days of Contractor's Notice to Proceed, provide a summary report of the examination review required in Part 3 "Examination", if issues are discovered that may preclude the proper testing and balancing of the systems.

- C. Examination Report: Provide a summary report of the examination review if issues are discovered that may preclude the proper testing and balancing of the systems.
- D. Certified T&B reports: Within 30 days of completion of balancing work, submit AABC-certified T&B report.
  - 1. Submit one copy of the final T&B Report directly to the design professional of record. Provide five additional copies to the contractor.

#### 1.05 QUALITY ASSURANCE

- A. T&B Contractor Qualifications:
  - 1. General Contractor will employ a T&B Agency that is certified by the Associated Air Balancing Council (AABC). The T&B Agency will have experience in the field of air and hydronic system balancing, possess calibrated instruments, and employ qualified Supervisors and skilled Technicians to perform all required tests. The T&B Agency shall have a minimum of 10 years of experience in the Testing, Adjusting, and Balancing field.
- B. T&B technician shall perform the following:
  - 1. Review field data reports to validate accuracy of data and to prepare certified T&B reports.
  - 2. Certify that the T&B team complied with the approved T&B plan and the procedures specified and referenced in this Specification.
  - 3. Certify the T&B report
- C. T&B Conference: If requested by the Owner or Construction Manager after approval of the T&B Agency's submittals, meet to develop a mutual understanding of the details
  - 1. Agenda Items:
    - a. The examination reports
    - b. The Strategies and Procedures plan
    - c. Systems readiness checklists
    - d. Coordination and cooperation of trades and subcontractors.
    - e. Coordination of documentation and communication flow.
- D. Approved Test and Balance agencies in the area:

**RS Analysis, Inc.**  
1035 Suncast Lane, Suite 130  
El Dorado Hills, CA 95762  
(916) 358-5672

**National Air Balance Company, Inc.**  
4171 Business Center Drive  
Fremont, CA 94538  
(510) 623-7000

**Raglen System Balance, Inc.**  
1121 University Terrace  
Reno, NV 89502  
(775) 747-0100

**Pacific Test & Balance, Inc.**  
4771 Mangels Blvd.  
Fairfield, CA 94534

(707) 696-2444

- E. T&B Report Forms: Use standard T&B contractor's forms.
- F. Instrumentation Type, Quantity, Accuracy, and Calibration: As described in "AABC National Standards for Total Systems Balance."

## **PART 2 PRODUCTS (NOT USED)**

## **PART 3 EXECUTION**

### **3.01 EXAMINATION & REVIEW**

- A. Review the Contractor shop drawing submittals for their effect on the test and balance process and overall performance of the HVAC system. Submit recommendations for enhancements or changes to the system.
- B. Review location and type of volume damper inlet conditions to air terminals, air valves, and HVAC equipment.
- C. Review location of pressure sensors in the air distribution system.
- D. Review automatic control systems as they affect the test and balance procedure.
- E. Review sheet metal and piping shop drawings to verify the installation of flow control devices.
- F. Examine systems for installed balancing devices, such as test ports, gage cocks, thermometer wells, flow-control devices, balancing valves and fittings, and manual volume dampers. Note the locations of devices that are not accessible for testing and balancing.
- G. Review the approved submittals for HVAC systems and equipment.
- H. Examine ceiling plenums and underfloor air plenums used for supply, return, or relief air to verify that they are properly separated from adjacent areas.
- I. Review equipment performance data including fan and pump curves.
- J. Examine HVAC equipment and verify that bearings are greased, belts are aligned and tight, clean permanent filters are installed, and controls are ready for operation.
- K. Examine terminal units, such as variable-air-volume boxes, and verify that they are accessible and their controls are connected, configured by the controls contractor and functioning.
- L. Examine strainers to verify that Mechanical Contractor has replaced startup screens with permanent screens and that all strainers have been cleaned.
- M. Examine two-way valves for proper installation and function.
- N. Examine heat-transfer coils for correct piping connections and for clean and straight fins.
- O. Examine air vents to verify that mechanical contractor has removed all air from all hydronic systems.

### **3.02 PREPARATION**

- A. Prepare a T&B plan that includes:
  - 1. Equipment and systems to be tested.
  - 2. Strategies and step-by-step procedures for balancing the systems.
  - 3. Instrumentation to be used.
  - 4. Sample forms with specific identification for all equipment.

- B. Prepare system-readiness checklists, as described in the *AABC National Standards for Total System Balance*, for use by contractors in verifying system readiness for T&B. These shall include, at a minimum:
  - 1. Airside:
    - a. All ductwork is complete with all terminals installed.
    - b. All volume, smoke and fire dampers are open and functional.
    - c. Clean filters are installed.
    - d. All fans are operating, free of vibration, and rotating in correct direction.
    - e. VFD start-up is complete and all safeties are verified.
    - f. Automatic temperature-control systems are operational.
    - g. Ceilings are installed.
    - h. Windows and doors are installed.
    - i. Suitable access to balancing devices and equipment is provided.

### **3.03 GENERAL PROCEDURES FOR TESTING AND BALANCING**

- A. Perform testing and balancing procedures on each system according to the procedures contained in AABC's "National Standards for Total System Balance" and in this Section.
- B. Cut insulation, ducts, pipes, and equipment cabinets for installation of test probes to the minimum extent necessary for T&B procedures.
- C. Mark equipment and balancing devices, including damper-control positions, valve position indicators, fan-speed-control levers, and similar controls and devices, with paint or other suitable, permanent identification material to show final settings.
- D. Take and report testing and balancing measurements in inch-pound (IP) units.

### **3.04 GENERAL PROCEDURES FOR BALANCING AIR SYSTEMS**

- A. Prepare test reports for both fans and outlets. Obtain approved submittals and recommended testing procedures. Crosscheck the summation of required outlet volumes with required fan volumes.
- B. Prepare single-line schematic diagram of systems for the purpose of identifying HVAC components.
- C. For variable-air-volume systems, develop a plan to simulate diversity.
- D. Determine the best locations in main and branch ducts for accurate duct-airflow measurements.
- E. Locate start-stop and disconnect switches, electrical interlocks, and motor starters.
- F. Verify that motor starters are equipped with properly sized thermal protection.
- G. Check condensate drains for proper connections and functioning.
- H. Check for proper sealing of air-handling-unit components.

### **3.05 PROCEDURES FOR CONSTANT-VOLUME AIR SYSTEMS**

- A. Adjust fans to deliver total indicated airflows within the maximum allowable fan speed listed by fan manufacturer.
  - 1. Measure total airflow.
    - a. Set outside air, return air and relief air dampers for proper position that simulates minimum outdoor air conditions.
    - b. Where duct conditions allow, measure airflow by Pitot-tube traverse. If necessary, perform multiple Pitot-tube traverses to obtain total airflow.

- c. Where duct conditions are not suitable for Pitot-tube traverse measurements, a coil traverse may be acceptable.
    - d. If a reliable Pitot-tube traverse or coil traverse is not possible, measure airflow at terminals and calculate the total airflow.
  2. Measure fan static pressures as follows:
    - a. Measure static pressure directly at the fan outlet or through the flexible connection.
    - b. Measure static pressure directly at the fan inlet or through the flexible connection.
    - c. Measure static pressure across each component that makes up the air-handling system.
    - d. Report any artificial loading of filters at the time static pressures are measured.
  3. Do not make fan-speed adjustments that result in motor overload. Consult equipment manufacturers about fan-speed safety factors. Modulate dampers and measure fan-motor amperage to ensure that no overload will occur. Measure amperage in full-cooling, full-heating, economizer, and any other operating mode to determine the maximum required brake horsepower.
- B. Adjust volume dampers for main duct, submain ducts, and major branch ducts to indicated airflows.
  1. Measure airflow of submain and branch ducts.
  2. Adjust sub-main and branch duct volume dampers for specified airflow. Re-measure each sub-main and branch duct after all have been adjusted.
- C. Adjust air inlets and outlets for each space to indicated airflows.
  1. Set airflow patterns of adjustable outlets for proper distribution without drafts.
  2. Measure airflow at all inlets and outlets.
  3. Adjust each inlet and outlet for specified airflow.
  4. Re-measure each inlet and outlet after all have been adjusted.
- D. Verify final system conditions.
  1. Re-measure and confirm minimum outdoor air, return and relief airflows are within design. Readjust to design if necessary.
  2. Re-measure and confirm total airflow is within design.
  3. Re-measure all final fan operating data, rpms, volts, amps, static profile.
  4. Mark all final settings.
  5. Test system in economizer mode. Verify proper operation and adjust, if necessary.
  6. Measure and record all operating data.
- E. Record final fan-performance data

### 3.06 PROCEDURES FOR VARIABLE-AIR-VOLUME SYSTEMS

- A. Adjust the variable-air-volume systems as follows:
  1. Verify that the system static pressure sensor is located 2/3 of the distance down the duct from the fan discharge.
  2. Verify that the system is under static pressure control.
  3. Select the terminal unit that is most critical to the supply-fan airflow. Measure inlet static pressure and adjust system static pressure control setpoint so the entering static pressure for the critical terminal unit is not less than the sum of the terminal-unit manufacturer's recommended minimum inlet static pressure plus the static pressure needed to overcome terminal-unit discharge system losses.
  4. Calibrate and balance each terminal unit for maximum and minimum design airflow as follows

- a. Adjust controls so that terminal is calling for maximum airflow (note some controllers require starting with minimum airflow. Verify calibration procedure for specific project).
- b. Measure airflow and adjust calibration factor as required for design maximum airflow. Record calibration factor.
- c. When maximum airflow is correct, balance the air outlets downstream from terminal units.
- d. Adjust controls so that terminal is calling for minimum airflow.
- e. Measure airflow and adjust calibration factor as required for design minimum airflow. Record calibration factor. If no minimum calibration is available, note any deviation from design airflow.
- f. When in full cooling or full heating, ensure that there is no mixing of hot deck and cold deck airstreams unless so designed.
- g. On constant volume terminals, in critical areas where room pressure is to be maintained, verify that the airflow remains constant over the full range of full cooling to full heating. Note any deviation from design airflow or room pressure.
5. After all terminals have been calibrated and balanced, test and adjust system for total airflow. Adjust fans to deliver total design airflows within the maximum allowable fan speed listed by fan manufacturer.
  - a. Set outside air, return air and relief air dampers for proper position that simulates minimum outdoor air conditions.
  - b. Set terminals for maximum airflow. If system design includes diversity, adjust terminals for maximum and minimum airflow so that connected total matches fan selection and simulates actual load in the building.
  - c. Where duct conditions allow, measure airflow by Pitot-tube traverse. If necessary, perform multiple Pitot-tube traverses to obtain total airflow.
  - d. Where duct conditions are not suitable for Pitot-tube traverse measurements, a coil traverse may be acceptable.
  - e. If a reliable Pitot-tube traverse or coil traverse is not possible, measure airflow at terminals and calculate the total airflow.
6. Measure fan static pressures as follows:
  - a. Measure static pressure directly at the fan outlet or through the flexible connection.
  - b. Measure static pressure directly at the fan inlet or through the flexible connection.
  - c. Measure static pressure across each component that makes up the air-handling system.
  - d. Report any artificial loading of filters at the time static pressures are measured.
7. Set final return and outside airflow to the fan while operating at maximum return airflow and minimum outdoor airflow.
  - a. Balance the return-air ducts and inlets the same as described for constant-volume air systems.
  - b. Verify all terminal units are meeting design airflow under system maximum flow.
8. Re-measure the inlet static pressure at the most critical terminal unit and adjust the system static pressure setpoint to the most energy-efficient setpoint to maintain the optimum system static pressure. Record setpoint and give to controls contractor.
9. Verify final system conditions as follows:
  - a. Re-measure and confirm minimum outdoor air, return and relief airflows are within design. Readjust to design if necessary.
  - b. Re-measure and confirm total airflow is within design.
  - c. Re-measure all final fan operating data, rpms, volts, amps, static profile.
  - d. Mark all final settings.

- e. Test system in economizer mode. Verify proper operation and adjust, if necessary. Measure and record all operating data.
- f. Verify tracking between supply and return fans.

### 3.07 PROCEDURES FOR CONDENSING UNITS

1. Verify proper rotation of fans.
2. Measure entering- and leaving-air temperatures.
3. Record fan and motor operating data.

### 3.08 TOLERANCES

1. Set HVAC system's air flow rates and water flow rates within the following tolerances:
  - a. Supply, Return, and Exhaust Fans and Equipment with Fans: plus or minus 10 percent.
  - b. Air Outlets and Inlets: plus or minus 10 percent.
2. Maintaining pressure relationships as designed shall have priority over the tolerances specified above.

### 3.09 ADDITIONAL TESTS

- A. Duct Leakage Test
  1. All ductwork shall be tested for leaks, using necessary instruments before insulating any ductwork. Conduct test as follows and as recommended in SMACNA Balancing Manual.
    - a. Seal all openings in duct section and plenum to be tested.
    - b. Connect test apparatus to test section of cuts, using a flexible duct connection or hose (fitting provided by Mechanical Contractor).
    - c. Close damper on blower suction side, to prevent excessive build-up of pressure.
    - d. Start blower and gradually open damper on suction side of blower.
    - e. Determine amount of air leakage and make repairs as required.
    - f. Leakage factor allowable shall be 5% based on the total operating cfm of the section of duct under testing.
    - g. Tested sections of ductwork shall be visually marked with certification sticker and initials of field test inspector. Tests shall be made before duct sections are concealed.
  2. Witness the duct pressure testing performed by the mechanical/installing contractor.
  3. Verify that proper test methods are used and that leakage rates are within specified tolerances.
  4. Report any deficiencies observed.
- B. Sound Level Reading
  1. After the systems are balanced and the spaces are architecturally complete, sound level readings shall be taken in at least ten locations in the building with an Octave Band Analyzer.
  2. In order to reduce the ambient noise level, the reading shall be taken at night.
  3. Instrumentation:
    - a. The sound-testing meter shall be a portable, general-purpose testing meter consisting of a microphone, processing unit, and readout.
    - b. The sound-testing meter shall be capable of showing fluctuations at minimum and maximum levels, and measuring the equivalent continuous sound pressure level (LEQ).
    - c. The sound-testing meter must be capable of using 1/3 octave band filters to measure mid-frequencies from 31.5 HZ to 8000 HZ.
    - d. The accuracy of the sound-testing meter shall be  $\pm 1$  decibel.

4. Test Procedures
    - a. Perform test at the quietest background noise period. Note any cause of unpreventable sound that may affect the test outcome.
    - b. Equipment should be operating at design values.
    - c. Calibrate the sound-testing meter prior to taking measurements.
    - d. Use a microphone suitable for the type of noise levels measured that is compatible with the meter. Provide a windshield for outside or in-duct measurements.
    - e. Record a set of background measurements in dB(A), and sound pressure levels in the eight un-weighted octave bands with the equipment off.
    - f. Take sound readings in dB(A), and sound pressure levels in the eight un-weighted octave bands with the equipment on.
    - g. Take readings no closer than 3' from a wall or from the operating equipment, and approximately 5' from the floor, with the meter held or mounted on a tripod.
    - h. For outdoor measurements, move the sound-testing meter slowly and scan the area that has the greatest exposure to the noise source being tested. (This type of reading is generally performed using the A-Weighted scale).
  5. Reporting
    - a. The test data for each area will be recorded on Noise Criteria curves indicating the decibel level read in each Frequency Band - the NC level required and the NC level measured. The sound level shall not exceed NC 30 in all areas.
    - b. The report must record: the location, the system tested, the dB(A) reading, and the sound pressure level in each octave band with equipment on and off.
    - c. Plot all the sound pressure levels on the [work sheet, with the equipment on and off.
  6. The T&B Agency will submit the test data and test equipment data to the Architect and Engineer for review, and include the approved forms in the T&B report.
- C. Vibration Testing
1. After the systems are balanced and the spaces are architecturally complete, read and record vibration levels on all equipment with motor horsepower equal to or greater than 10. Vibration field measurements shall be taken as required for each circulating water pump, water chilling unit, air handling unit, and fan driven by a motor over 10 hp. Reading shall include shaft alignment, equipment vibration, bearing housing vibration, foundation vibration, and building structure vibration.
  2. Instrumentation:
    - a. The vibration meter should be portable, battery-operated, and microprocessor-controlled, with or without a built-in printer.
    - b. The meter shall automatically identify engineering units, filter bandwidth, amplitude and frequency scale values.
    - c. The meter shall be able to measure machine vibration displacement in mils of deflection, velocity in inches per second, and acceleration in inches per second squared.
  3. Test Procedures:
    - a. Verify that the vibration meter calibration date is current before taking readings.
    - b. To ensure accurate readings, verify that the accelerometer has a clean, flat surface and is mounted properly.
    - c. With the unit running, set up the vibration meter in a safe, secure location. Connect the transducer to the meter with the proper cables. Hold the magnetic tip of the transducer on top of the bearing, and measure the unit in mils of deflection. Record the measurement, then move the transducer to the side of the bearing, and record in mils of deflection. Record an axial reading in mils of deflection by holding the nonmagnetic, pointed transducer tip on the end of the shaft.



- d. Change the vibration meter to velocity (inches per second) measurements. Repeat and record the above measurements.
  - e. Record the CPM or the RPM.
  - f. Read each bearing on the motor, fan, and/or pump as required. Track and record vibration levels from the rotating component through the casing to the base.
4. Reporting
- a. The report must record the location and the system tested.
  - b. Include horizontal-vertical-axial measurements for all tests.
  - c. Verify that vibration limits follow specifications, or, if not specified, follow the "General Machinery Vibration Severity Chart" or "Vibration Acceleration General Severity Chart" from the AABC National Standards. Acceptable levels of vibration are normally "Smooth" to "Good."
  - d. Include in the report the Machinery Vibration Severity Chart, with conditions plotted.
5. Maximum vibration at any point listed above shall not exceed criteria listed in the ASHRAE Handbook, HVAC Systems and Application, Chapter 52 "Sound and Vibration Control", Table 26 "Equipment Vibration Criteria", unless otherwise specified. Reading shall be taken with vibration isolation blocked solid to the foundation.
6. The T&B Agency will submit the test data and equipment data to the Mechanical Engineer for review. The approved forms will be included in the T&B report.
- D. Controls Verification
1. In conjunction with system balancing perform the following:
    - a. Work with the temperature control contractor to ensure the system is operating within the design limitations and gain a mutual understanding of intended control performance.
    - b. Verify the integrity of valves and dampers in terms of tightness of close-off and full-open position. This includes dampers in multi-zone units.
    - c. Check that all valves are properly installed in the piping system in relation to direction of flow and location.
    - d. Verify the proper application of all normally open and normally closed valves.
    - e. Check the locations of all thermostats and humidistats for potential erratic operation from outside influences such as sunlight, drafts or cold walls.
    - f. Check the locations of all sensors to determine whether their position will allow them to sense only the intended temperatures, humidities, or pressures. Control Contractor will relocate as deemed necessary by the TAB Agency.
    - g. Check the sequence of operation for any control mode is in accordance with approved shop drawings. Verify that only minimum simultaneous heating and cooling occurs. Observe that heating cannot take place until the cooling zone of valve is completely closed.
    - h. Verify that all controller set points meet the design intent.
    - i. Verify the operation of all interlock systems.
    - j. Verify that controllers are calibrated and function as intended.
    - k. Verify that controller setpoints are as specified.
    - l. Verify the operation of lockout or interlock systems.
    - m. Verify the operation of all valve and damper actuators.
    - n. Verify that all controlled devices are properly installed and connected to the correct controller.
    - o. Verify that all controlled devices travel freely and are in the position indicated by the controller: open, closed, or modulating.
    - p. Perform all system verification to assure the safety of the system and its components.

2. Reporting
  - a. The report shall include a summary of verifications performed, remaining deficiencies, and any variations from specified conditions.
3. A systematic check of the above requirements shall be included in the final TAB report.

### 3.10 FINAL TEST AND BALANCE REPORT

- A. The report shall be a complete record of the HVAC system performance, including conditions of operation, items outstanding, and any deviations found during the T&B process. The final report also provides a reference of actual operating conditions for the owner and/or operations personnel. All measurements and test results that appear in the reports must be made on site and dated by the AABC technicians or test and balance engineers.
- B. The report must be organized by systems and shall include the following information as a minimum:
  1. Title Page:
    - a. AABC certified company name
    - b. Company address
    - c. Company telephone number
    - d. Project identification number
    - e. Location
    - f. Project Architect
    - g. Project Engineer
    - h. Project Contractor
    - i. Project number
    - j. Date of report
    - k. AABC Certification Statement
    - l. Name, signature, and certification number of AABC TBE
  2. Table of Contents.
  3. AABC National Performance Guaranty.
  4. Report Summary:
    - a. The summary shall include a list of items that do not meet design tolerances, with information that may be considered in resolving deficiencies.
  5. Instrument List:
    - a. Type.
    - b. Manufacturer.
    - c. Model.
    - d. Serial Number.
    - e. Calibration Date.
  6. T&B Data:
    - a. Provide test data for specific systems and equipment as required by the most recent edition of the "AABC National Standards."
  7. Print or sketch, reduced in size, showing all supply, return and exhaust air outlets for easy reference to report data.
- C. One copy of the final test and balance report shall be sent directly to the Mechanical Engineer of record. Provide five additional copies to the contractor.
- D. An approved copy of the balancing report shall be included in the maintenance manual submittal.

### **3.11 FINAL ACCEPTANCE**

- A. At the time of final inspection, the T&B Agency shall recheck, in the presence of the Owner's Representative, specific and random selections of data, i.e. water and air quantities, recorded in the Certified Report.
- B. Points and areas for recheck shall be selected by the Owner's Representative.
- C. Measurement and test procedures shall be the same as approved for work forming basis of Certified Report.
- D. Selections for recheck, specific plus random, will not normally exceed 25% of the total number tabulated in the report, except that special air systems may require a complete recheck for safety reasons.
- E. If random tests elicit a measured flow deviation of 10% or more from that recorded in the Certified Report listings, by 10% or more of the selected recheck stations, the report shall be automatically rejected. In the event the report is rejected, all systems shall be readjusted and tested, new data recorded, new Certified Report submitted, and new inspection tests made, all at no additional cost to the Owner.
- F. Following final acceptance of the Certified Report by the Owner's Representative the settings of all valves, splitters, dampers, and other adjustment devices shall be permanently marked by the T&B Agency, so that adjustment can be restored if disturbed at any time. Devices shall not be marked until after final acceptance.

**END OF SECTION**

## SECTION 23 0923

### ENERGY MANAGEMENT SYSTEM FOR HVAC (EMS)

#### PART 1 - GENERAL

##### 1.01 SUMMARY

- A. Section includes equipment and performance criteria for furnishing all labor and materials for the installation and programming for Energy Management System for HVAC Systems utilizing wireless communication with cloud-based servers.

##### 1.02 RELATED SECTIONS

- A. Division 01: General Requirements
- B. Section 23 0000: Heating, Ventilating, and Air-Conditioning (HVAC)

##### 1.03 SUBMITTALS

- A. Shop Drawings and product data in accordance with the specifications.
- B. All shop drawings shall be prepared in AutoCAD 2012 or newer. In addition, Contractor shall provide drawings in electronic format with x-ref and layer information to other trades as required.
- C. All submittals shall be bound or in a three-ring binder with a table of contents and related section tabs. Five (5) copies shall be submitted to the Architect for distribution and review prior to ordering or fabrication of the equipment. The Contractor, prior to submitting, shall check all documents for accuracy.
- D. Shop drawings shall include basic floor plans depicting locations of all equipment and wiring installed by others, to be controlled by system and locations of thermostats, gateways and other equipment provided under this section. Drawings shall also show location of electrical power, low voltage wiring and data ports, provided by others, required for proper installation of systems of this section.
- E. Submittal data shall contain manufacturer's data on all hardware and software products required by the specification.

##### 1.04 SCOPE OF WORK

- A. Except as otherwise noted, the control system shall consist of all thermostats, and gateways to fill the intent of the specification and provide for a complete and operable system.
- B. The EMS Contractor shall review and study existing building/site conditions where applicable and all new construction drawings for the project, including HVAC drawings, and the entire project specifications to familiarize themselves with the equipment and system operation prior to bidding and submittal of a bid/price. The Contractor shall notify the Owner immediately of any conflicts between the project and the scope of work of this Section, including work to be completed by others.
- C. All equipment and installation of control devices associated with the equipment listed below shall be provided under this Contractor.
- D. When the EMS system is fully installed and operational, the EMS Contractor shall make themselves available to meet with the designated representatives of the Owner to review the as-installed condition of the system. At that time, the EMS Contractor shall demonstrate the

- operation of the system and prove that it complies with the intent of the Drawings and Specifications.
- E. The Contractor shall furnish and install a complete EMS control system including all necessary hardware and all operating and applications software necessary to perform the control sequences of operation. Provide and install EMS controls for the HVAC equipment as noted on the Drawings:
    - 1. Provide technical support necessary for commissioning of system in coordination with the HVAC Contractor, Balancing Contractor and the owner's team.
    - 2. Contractor shall provide one training session in the operation of the system, for owner's personnel.
  - F. EMS Contractor shall provide economizer controller for the Daikin AEQ unit ventilators along with the thermostat. Provide thermostats and tie into Daikin AHF unit ventilators via a terminal strip.
  - G. EMS Contractor shall provide all wiring between sensors and wireless thermostats.
  - H. All work performed under this Section of the Specifications shall be in compliance with all codes and regulations as mandated by the authority having jurisdiction.

#### 1.05 SYSTEM DESCRIPTION

- A. The Energy Management System (EMS) shall consist of thermostats, gateways and related accessories as indicated below and all related programming for a complete and fully operational web-based management system, using a cloud server program complying with the following specifications.
- B. The entire Energy Management Solution (EMS) shall include a network of commercial Internet programmable thermostats which use IEEE 802.15.4 mesh wireless communication protocol to reach a Wireless Gateway (WG). The WG must connect to the owner's wide area network (WAN) over a TCP/IP connection. Access and control of EMS is through a web-based management tool which sits on a cloud server and must be accessible either locally or remotely via the Internet.

#### 1.06 WORK BY OTHERS

- A. The EMS Contractor shall coordinate with other Contractors prior to performing the work on this project and cooperate as necessary to achieve a complete and neat installation. To that end, each Contractor shall consult the Drawings and Specifications for all trades to determine the nature and extent of others' work prior to fabrication and installation. The Owner's representative shall be immediately notified if an area of conflict occurs between trades prior to fabrication and installation. EMS Contractor shall provide field supervision to the Mechanical Contractor for pre-installation of control components.
- B. Low voltage thermostat wiring between equipment and thermostat locations shall be furnished and installed by others. Unless noted otherwise all new low voltage wiring shall be multiple conductor thermostat wiring (wire count as indicated in thermostat manufacture's installation instructions) installed per Owner's specifications. (Wiring in existing installations shall be minimum 3 conductor / 24-gauge wires per EMS manufacturer's standard specifications, multiple c conductor / 24-gauge thermostat wiring preferred - see Installation Instructions for specific conductor counts depending on heating and cooling modes of existing equipment.)
- C. Related work provided by others:
  - 1. 110 V outlets shall be provided within 5 feet of each gateway location.
  - 2. 1 Data port shall be provided within 10 feet of each gateway location.

- D. Equipment start-up and servicing

#### **1.07 CODE COMPLIANCE**

- A. Provide EMS components and ancillary equipment which are code compliant.
- B. All wiring shall conform to the National Electrical Code.
- C. All products of the EMS shall reside with the following agency approvals.
  - 1. California 2019 Title 24 Compliant.
  - 2. California Energy Commission Occupant Control Smart Thermostat (OCST) certified.
  - 3. Open ADR2.0 certified.

#### **1.08 SYSTEM STARTUP & COMMISSIONING**

- A. Each EMS component in the system shall be tested for both hardware and software functionality. In addition, each mechanical and electrical system under control of the EMS shall be tested against the appropriate sequence of operation specified herein. Successful completion of the system test shall constitute the beginning of the warranty period. A written report shall be submitted to the Owner indicating that the installed system functions in accordance with the Drawings and Specifications.
- B. The EMS Contractor shall provide all manpower and engineering services required to assist the HVAC Contractor and Balancing Contractor in testing, adjusting, and balancing all systems in the building. The EMS Contractor shall have a trained technician available on request during the balancing of the systems. The EMS Contractor shall coordinate all requirements to provide a complete air balance with the Balancing Contractor and shall include all labor and materials in his contract to assist with functional testing of system as it relates to EMS.

#### **1.09 TRAINING**

- A. The EMS Contractor shall provide training for two owner's representatives and/or maintenance personnel. The EMS Contractor shall provide on-site training to the District's representative(s) and maintenance personnel per the following description:
  - 1. On-site training shall consist of a minimum of one hour of hands-on instruction geared at the operation and maintenance of the systems. The curriculum shall include
    - a. System Overview
    - b. System Software and Operation
    - c. System access
    - d. Software features overview
    - e. Changing set points and other attributes
    - f. Scheduling
    - g. Editing programmed variables
    - h. Displaying color graphics
    - i. Running reports
    - j. Workstation maintenance
    - k. Application programming
    - l. Operational sequences including start-up, shutdown, adjusting and balancing.
    - m. Equipment maintenance

#### **1.10 OPERATING AND MAINTENANCE MANUALS**

- A. The operation and maintenance manuals shall contain all information necessary for the operation, maintenance, replacement, installation, and parts procurement for the entire EMS. This documentation shall include specific part numbers.

- B. Following project completion and testing, the EMS Contractor shall submit as-built documentation reflecting the exact installation of the system.

### **1.11 WARRANTY**

- A. The EMS contractor shall warrant the system for 12 months after system acceptance and beneficial use by the District. During the warranty period, the EMS contractor shall be responsible for all necessary revisions to the software as required to provide a complete and workable system consistent with the letter and intent of the Sequence of Operation section of the specification. EMS equipment shall be warranted for a period of 5 years from the time of system acceptance.
- B. Warranty of equipment is limited to replacement of defective products.

## **PART 2 - PRODUCTS**

### **2.01 ACCEPTABLE MANUFACTURERS**

- A. Unless noted otherwise, all products shall be of a single manufacturer. The standard of design and quality shall be products as manufactured by Pelican Wireless Systems.
- B. Products of other manufacturers shall be considered for acceptance provided they equal or exceed the material requirements and functional requirements of the specified product. A request for Architect's approval must be submitted with complete technical data to allow for proper evaluation. All materials for evaluation must be received by Project Manager at least 10 days prior to bid due date.

### **2.02 WIRELESS GATEWAY (WG)**

- A. A single WG shall be capable of providing communication between a dedicated cloud server using TCP/IP and the on-site Internet Programmable Thermostats using the IEEE 802.15.4 wireless communication protocol. Additional WGs can be used for a single site, but each WG must meet or exceed these requirements.
- B. The WG must provide the following hardware features as a minimum:
  - 1. Single Ethernet Port.
  - 2. One micro-USB 5VDC power input.
  - 3. 2.4 GHz IEEE std. 802.15.4 built-in communication processor.
- C. The WG shall provide the communication link between the entire system and a cloud-based server. Communication with cloud server shall be secured using AES (Advanced Encryption Standard).
- D. The WG shall be able to support 2000 Internet Programmable Thermostats.

### **2.03 INTERNET PROGRAMMABLE THERMOSTAT (IPT)**

- A. Internet Programmable Thermostat shall be a wireless communicating commercial programmable thermostat that uses IEEE 802.15.4 for networking communication and a wiring terminal block for controlling a single zone HVAC unit.
- B. The IPT shall provide a keypad for setting:
  - 1. Temperature Set points.
  - 2. System Mode (Heat, Cool, Auto, Off).
  - 3. Fan Mode (Auto, On).
  - 4. Light Button.

- C. The IPT shall include a wiring terminal for controlling a single zone HVAC unit. The wiring terminal must be able to be removed from the IPT for installations where only 3-wires exist or are available between where the IPT shall be placed and its connection with the HVAC unit it shall be controlling. Over these 3-wires the thermostat must still be able to control the HVAC unit based on these specifications.
- D. The IPT must be configurable using a Web Based App. No thermostat configuration, other than setting the IPT to Conventional, Heat Pump - O, or Heat Pump -B, shall be done at the thermostat. Web based Configuration Setting options shall include:
  - 1. Naming the thermostat
  - 2. Grouping multiple thermostats.
  - 3. Heat Pump or Conventional system setting.
  - 4. If Heat Pump; reversing valve O or B setting.
  - 5. Cycles Per Hour (1 - 6).
  - 6. Anticipation Degrees (0°F - 0.5°F)
  - 7. Calibration Degrees (2.0°F - -2.0°F)
  - 8. Heat Stages (0 - 2)
  - 9. If Heat Pump; Aux Heat (Disabled and/or Enabled Option)
  - 10. Cool Stages (0 - 2)
  - 11. Fan Stages (1 - 2)
  - 12. Fan Circulation Minutes Per Hour.
  - 13. Temperature Display (Fahrenheit or Celsius)
  - 14. Heat Range Temperature Setting Limitation
  - 15. Cool Range Temperature Setting Limitation
  - 16. Ability to disable and enable Keypad Control through schedule.
  - 17. Heat consumption (kw, btu, ton, or watt)
  - 18. Cool consumption (kw, btu, ton, or watt)
  - 19. Notification Sensitivity (High, Medium, Low)
  - 20. Alarm of exceeding temperature based on a Safe Range
  - 21. Schedule set times (2, 3, 4, or Variable).
- E. IPT settings and control through the Web Base App shall be in real-time and include:
  - 1. Space Temperature
  - 2. System Mode (Heat, Cool, Auto, Off).
  - 3. Fan Mode (Auto, On).
  - 4. Current set point.
  - 5. Relay status (Heat/Cool and Fan).
  - 6. Historical Trend Graphs.
  - 7. Scheduling
  - 8. Lock and Unlock Entire Thermostat's Keypad
  - 9. Lock and Unlock the Thermostat's Fan Mode setting Only

#### **2.04 WEB BASED GRAPHICAL USER INTERFACE**

- A. The Web Based App (WBA) shall be able to run on any PC that uses Safari, Chrome, Firefox, or any other web browser that meets these browsers' functionality.
- B. The WBA Platform shall be able to run on any Internet Accessible Smartphone and/or Tablet that has a Web Browser compatible with HTML5.
- C. The WBA shall allow up to a minimum of 100 simultaneous users/clients to access the Energy Management System.
- D. The Web Based client shall support at a minimum, the following functions:
  - 1. User log-on identification and password shall be required.



2. HTML programming shall not be required to display any graphics or data on the Web page.
  3. Storage of data shall reside within the cloud server and shall not sit within the client's computer or device. EMS that requires data storage on a client computer or an on-site server is not acceptable.
  4. Users shall have administrator and user definable access privileges.
  5. Open API interface with XML data output.
- E. Schedules:
1. The WBA shall provide user with access to setting Internet Programmable Thermostat (IPT) schedules. Up to 12 schedule periods per day shall be available for each IPT.
  2. Schedules shall be available as Weekly (7-day), Daily, or Weekday/Weekend (5-2).
  3. The WBA shall provide the user the ability to:
    - a. View Schedules.
    - b. Add/Modify Schedules.
    - c. Assign Thermostat to a Group Schedule.
    - d. Delete Schedules.
- F. Trending
1. The WBA shall provide real-time trend information on:
    - a. Each IPT's space temperature.
    - b. Each IPT's temperature set points.
    - c. Each IPT's current call; heat, cool, and/or fan.
    - d. Each IEE's call for economization
  2. The WBA shall be able to record and provide at least two years of past trend data for every thermostat in the wireless network. Trend data shall include:
    - a. space temperature; with resolution of every 1/10th of a degree Fahrenheit.
    - b. IPT's temperature set points.
    - c. indication of whether the thermostat was calling for; heat, cool, and/or fan.
  3. Trend data shall be viewable on the WBS
- G. Alarm Notifications
1. The WBA shall provide automatic alarming functionally based on real-time monitoring of at least:
    - a. space temperature and temperature change.
    - b. IPT's temperature set points.
    - c. IPT's current call; heat, cool, and/or fan.
  2. The WBA shall be able to provide a user with the ability to:
    - a. View Alarms.
    - b. Set Alarm Notification sensitivity level to High, Medium, or Low.
    - c. Delete Alarms.
  3. Alarms shall be able to be sent via email and/or text message to up to 100 or more clients.
- H. Consumption Usage
1. The WBA shall be able to calculate and graphically display the consumption of running a single zone HVAC unit based on a user defined HVAC unit heat and/or cool consumption rate multiplied by the thermostat heat/cool call time.
  2. The WBA shall be able to calculate and graphically display the cost of consumption of running a single zone HVAC unit based on taking a user defined HVAC unit heat and/or cool consumption and multiplying that by the client defined cost per kw and/or therm.
  3. The WBA shall be able to display consumption usage for a single thermostat, multiple thermostats at a single time, or all the thermostats in the EMS.
  4. The WBA shall be able to record and display up to at least two years of consumption usage information.

## 2.05 WIRED REMOTE TEMPERATURE SENSORS AND DIGITAL ALARM INPUT

- A. Input Temperature Sensor (ITS).
  - 1. The ITS shall connect to the Internet Programmable Thermostat over 3-wires.
  - 2. ITS shall provide at least one external 10K Type II thermistor temperature sensor input.
  - 3. Web Based App shall be able to record and provide at least two years of past temperature data for ITS.
  - 4. The trend data shall be viewable on the WBA.
  - 5. ITS must be accurate to  $\pm 1.0^{\circ}\text{F}$
  - 6. ITS must be able to be installed up to 500' away from IPT using standard thermostat wiring.

## 2.06 INTERNET ENABLED ECONOMIZER (IEE)

- A. The IEE shall connect to the Internet Programmable Thermostat (ITS) with ONLY 3-wires. No additional wiring must be required between the IEE and the ITS to gain complete Title 24 compliant economization control.
- B. IEE shall provide up to three 10K Type II external thermistor temperature sensor input.
- C. Web Based App shall be able to record and provide at least two years of past data for IEE. Data must represent historical representations of:
  - 1. Calls for Economization
  - 2. Outside Air Damper Position
  - 3. Supply and Outside Air Temperature
  - 4. The trend data shall be viewable on the WBA.
  - 5. IEE must be able to send California Title 24 Fault and Diagnostics codes to the WBA, email addresses, and or text messages.
  - 6. IEE must be able to be installed up to 500' away from IPT using standard thermostat wiring.
  - 7. IEE must have a settable 0-10VDC output for Outside Air Damper Actuator control.
  - 8. IEE must have a settable 0-10VDC output for Variable Frequency Drive (VFD) control.
  - 9. IEE must be configurable for different VFD speeds based on calls for cold, heat, and ventilation.
  - 10. IEE must have a 0-10VDC input for Outside Air Damper Position Feedback.

## 2.07 WIRELESS PROXIMITY SENSORS

- A. Wireless Proximity Sensor (WPS).
  - 1. The WPS shall connect with the Internet Programmable Thermostat over the 802.15.4 wireless network.
  - 2. WPS shall be powered by 2 AA batteries or equivalent.
  - 3. WPS must be able to be used for either:
    - a. Accepting a motion sensor's 2-wire dry contact output.
      - 1) The WPS shall be able to notify an Internet Programmable Thermostat if a motion sensor's dry contact is in either the open or closed position.
      - 2) Dry contact open positions shall indicate that the space is occupied and the IPT must be able to automatically setback its temperature setting by a range of  $0^{\circ}\text{F}$  -  $10^{\circ}\text{F}$  or OFF.
      - 3) Dry contact closed position shall indicate that the space is unoccupied and set the temperature to a comfort setting when the space is occupied.
      - 4) Setback settings and comfort settings must be settable through the Internet Programmable Thermostat's schedule through the Web Based App (cannot be settable at thermostat).

- 5) Web Based App must be able to display when a space is "Unoccupied".
- b. Detecting if a Window or Door is Opened or Closed.
  - 1) The WPS must have a built-in magnetic sensor and come with a magnet that can be installed on a door or window.
  - 2) The WPS must be able to notify an Internet Programmable Thermostat if the door is open and the IPT must automatically turn to the OFF position.
  - 3) The WPS must be able to notify an Internet Programmable Thermostat if the door is closed and the IPT must automatically return to its last temperature and system settings.
  - 4) Web Based App must be able to display when the Door or Window is Open and must be able to be set to indicate "Door" or "Window".
- c. Web Based App shall be able to notify if the WPS batteries are low and record and provide at least two years of past history on occupancy and/or door/window status for each space a WPS is installed in.
- d. The trend data shall be viewable on the Web Based App.
- e. Internet Programmable Thermostat must be able to connect with at least 8 WPS, each WPS must have a unique serial number and each WPS shall be settable, through the Web Based App, as either a motion sensor input or as a door/window sensor.

### **PART 3 - EXECUTION**

#### **3.01 CONTRACTOR RESPONSIBILITIES**

- A. General
  1. Installation of the Energy Management System shall be performed by an approved Contractor. The Contractor shall certify all work as proper and complete. Under no circumstances shall the design, scheduling, coordination, programming, training, and warranty requirements for the project be delegated to a subcontractor without prior written approval of the owner.
- B. Demolition
  1. Remove controls which do not remain as part of the Energy Management System. The Owner shall inform the Contractor of any equipment which is to be removed that shall remain the property of the Owner. All other equipment which is removed shall be disposed of by the Contractor.
- C. Access to Site
  1. Unless notified otherwise, entrance to building is restricted. No one shall be permitted to enter the building unless their names have been cleared with the District or the District's Representative.
- D. Code Compliance
  1. All wiring shall be installed in accordance with all applicable electrical codes and shall comply with equipment manufacturer's recommendations.
- E. Cleanup
  1. At the completion of the work, all equipment pertinent to this Section shall be checked and thoroughly cleaned, and all other areas shall be cleaned around equipment provided under this Section.

#### **3.02 WIRING, CONDUIT, AND CABLE**

- A. All control wires between HVAC units and thermostat locations to be furnished and installed by others. The EMS contractor shall not begin work on this contract until all wiring is installed to the satisfaction of the EMS contractor. The EMS contractor shall provide wiring between remote

temperature sensors, TA1 and thermostats as required, unless noted otherwise in Drawings or Specifications.

### 3.03 HARDWARE INSTALLATION

- A. Installation Practices for Devices
  - 1. All devices are to be mounted level/plumb and per the manufacturer's installation documentation.
- B. Identification
  - 1. Identify all control wires with labeling tape or sleeves using either words, letters, or numbers that can be exactly cross-referenced with as-built drawings.
  - 2. All field enclosures, other than controllers, shall be identified with a back lite nameplate. The lettering shall be in white against a black or blue background.
  - 3. Junction box covers shall be marked to indicate that they are a part of the EMS system.
  - 4. All I/O field devices (except space sensors) that are not mounted within FIP's shall be identified with name plates.
  - 5. All I/O field devices inside FIP's shall be labeled.
- C. Existing Controls.
  - 1. Existing controls are not to be reused. All EMS devices shall be new.
- D. Control System Switch-over
  - 1. The Contractor shall minimize control system downtime during switch-over. Sufficient installation mechanics shall be on site so that the entire switch-over can be accomplished in a reasonable time frame.
- E. Location
  - 1. The location of sensors is per mechanical and architectural drawings.
  - 2. Space humidity or temperature sensors shall be mounted away from machinery generating heat, direct light and diffuser air streams.
  - 3. If Input Temperature Sensor(s) (ITS) is used as Outdoor air sensor, Outdoor air sensors shall be mounted on the north building face directly in the outside air. Install sensors such that the effects of heat radiated from the building or sunlight is minimized.
  - 4. If any line voltage electrical control is being installed, field enclosures shall be located immediately adjacent to the controller panel(s) to which it is being interfaced.

### 3.04 SYSTEM PROGRAMMING

- A. General.
  - 1. The Contractor shall provide all labor necessary to install, initialize, start-up and debug all system software as described in this section. This includes any operating system software.
  - 2. Contractor shall work with owner's representative to determine programming parameters including but not limited to hours of operation, set points, system variables, thermostat naming, and site naming. Thermostat & Site naming shall be performed by the contractor. Naming convention (equipment # or name, or space served) shall be provided by or agreed upon with the Owner.

### 3.05 COMMISSIONING AND SYSTEM STARTUP

- A. EMS device functional testing.
  - 1. Each system for which a EMS device has been installed shall be tested for proper installation and functional operation. Test shall include on-site control test to verify each wireless device is responding to signals sent from cloud based servers and responding in accordance with manufacture's specifications.

**END OF SECTION**

**SECTION 26 0500**  
**BASIC ELECTRICAL REQUIREMENTS**

**PART 1 - GENERAL**

**1.01 WORK INCLUDED**

- A. Work included in this Section: All materials, labor, equipment, services, and incidentals necessary to provide and install the Electrical Work as shown on the drawings and as specified hereinafter, including, but not limited to the following:
  - 1. Electrical and telecommunications service provisions as outlined on the drawings, including temporary power for construction.
  - 2. Distribution panels, branch panels, transformers, circuit breakers, and feeders.
  - 3. Branch circuit wiring, wiring devices and connections to all equipment requiring electrical service.
  - 4. Lighting fixtures completely lamped, including switches, raceways and wiring.
  - 5. Emergency egress/exit illumination system.
  - 6. Central Emergency Lighting Inverters.
  - 7. Telecommunications system.
  - 8. Fire Alarm system.
  - 9. Mechanical equipment power connections, and motor starters where noted.
  - 10. Low voltage lighting control system and programming.
  - 11. Clock/Speaker system (IP based).
  - 12. All required incidental work, such as roof flashing, electrical testing, title 24 acceptance testing, and temporary power.
  - 13. Any other electrical work as might reasonably be implied as required, even though not specifically mentioned herein or shown on the the drawings.
  - 14. It is the intent of the drawings and specifications that systems be complete and, except as otherwise noted, be ready for operation.

**1.02 RELATED WORK**

- A. Division 1 - General Requirements
- B. Division 9 - Finishes
- C. Division 23 - Mechanical
- D. Section 07270 - Firestopping

**1.03 INCORPORATED DOCUMENTS**

- A. Requirements of the General Conditions, Supplementary Conditions, and Division 1 Sections apply to all work in this Section, unless modified herein.
- B. Published specifications, standard tests or recommended methods of trade, industry or government organizations apply to work of this Section where cited by abbreviations noted below, unless modified herein.
  - 1. 2019 California Code of Regulations.
  - 2. 2019 California Building Standards Administrative Code, Part 1, Title 24, C.C.R.
  - 3. 2019 California Building Code (CBC), Part 2, Title 24, C.C.R. (Based on 2018 International Building Code with 2019 California Amendments).
  - 4. 2019 California Electrical Code (CEC), Part 3, Title 24, C.C.R. (Based on 2017 National Electrical Code with 2019 California Amendments).
  - 5. California Energy Code, Part 6, Title 24, C.C.R.
  - 6. 2019 California Fire Code (CFC), Part 9, Title 24, C.C.R. (Based on 2018 International Fire Code with 2019 California Amendments).
  - 7. 2019 California Green Building Standards (CALGreen) Code, Part 11.

8. American Society of Civil Engineers 7-10 (ASCE/SEI), Minimum Design Loads for Buildings and Other Structures.
9. Underwriters' Laboratories, Inc. (UL).

C. All State and Municipal Codes and Ordinances.

#### **1.04 CONDITIONS AT SITE:**

- A. Visit to site is required of all bidders prior to submission of bid. All will be held to have familiarized themselves with all discernible conditions and no extra payment will be allowed for work required because of these conditions, whether specifically mentioned or not.
- B. Lines of other services that are damaged as a result of this work shall promptly be repaired at no expense to the Owner to the complete satisfaction of the Owner.

#### **1.05 QUALITY ASSURANCE**

- A. Conformance:
  1. All work shall conform to the applicable requirements of Article 1.03 above.
  2. The Contractor shall notify the Architect, prior to submission of bid, about any part of the design, which fails to comply with abovementioned requirements.
  3. If after contract is awarded, minor changes and additions are required by aforementioned authorities, even though such work is not shown on the drawings or covered in the specifications, they shall be included at Contractor's expense.
- B. Coordination:
  1. The Contractor shall become familiar with the conditions at the job site, and with the drawings and specifications and plan the installation of the electrical work to conform with the existing conditions and that shown and specified so as to provide the best possible assembly of the combined work of all trades.
  2. The Contractor shall work out in advance all "tight" conditions, involving all trades and if found necessary, supplementary drawings shall be prepared by this Contractor, for the Architect's approval, before work proceeds in these areas. No additional costs will be considered for work, which must be relocated due to conflicts with the work of other trades.
  3. The Contractor shall coordinate and verify all backbox, device, lighting fixture, or equipment mounting requirements with the devices or equipment to be installed, prior to rough in.

#### **1.06 SUBMITTALS**

- A. Product Data:
  1. Comply with the provisions of Section 01 33 00 - Submittals.
  2. Within 15 days after award of the Contract, submit:
    - a. Complete electrical, lighting, and signal systems material list of all items proposed to be furnished and installed under this Division. Provide manufacturers data sheets for all devices, raceways, fixtures, equipment, and related products to be used for the Division 26, 27, and 28 work.
    - b. Manufacturers' specifications and other data required demonstrating compliance with the specified requirements.
    - c. Manufacturers' recommended installation procedures which, when approved by the Architect, shall become the basis for inspecting and accepting or rejecting actual installation procedures used on the work.
  3. Shop Drawings: Furnish shop drawings and/or equipment cuts for the following:
    - a. Light fixtures including lamps and ballasts
    - b. Distribution panels, panel boards, and transformers. Panel board submittals shall include diagrams of the circuit breaker arrangements in the panels. Arrange circuit

- breakers in panels exactly as shown on the panel schedules in the construction documents.
- c. Fire alarm system
  - d. Telecommunications system
  - e. Disconnect switches
  - f. Motor starters
  - g. Low voltage lighting control system
  - h. Central Emergency Lighting Inverter.
  - i. Clock/Speaker system as specified herein and/or indicated on the drawings.
  - j. Assisted Listening system as specified herein and/or indicated on the drawings.
4. Test Reports:
- a. Factory Tests: As specified for specific equipment.
  - b. Field Tests: Performance tests as specified for specific equipment.
  - c. Megger Tests: As specified under TESTING.
  - d. When series rated circuit breakers are used, provide a letter from the manufacturer of the equipment confirming that U.L. series rating exists for all protective devices. State the available fault current from the Utility Company and indicate that the overcurrent devices exceed the available fault current at the respective point of protection.
  - e. Special Seismic Certification documentation as per CBC Section 1616A and ASCE/SEI 7-10 requirements for all equipment defined as 'critical' with an importance factor of 1.5 in Paragraph 1.10.M.3 of this Section.
  - f. Manufacturer's Seismic Certification or Project-Specific Design of Supports and Attachments for all other equipment and fixtures as per CBC Section 1616A and ASCE/SEI 7-10 requirements.
5. Maintenance and Operating Manuals:
- a. Systems Description: Description of operating procedures.
  - b. Controls: Diagrams and description of operation of each system.
  - c. Equipment: Manufacturer's brochures, ratings, certified shop drawings, maintenance data, and parts lists with part numbers. Mark each sheet with equipment identification number and actual installed condition.
  - d. Materials and Accessories: Manufacturer's brochures, parts lists with part numbers, and maintenance data where applicable. Mark each sheet with identification number of system and location of installation.
  - e. The Maintenance and Operation Manual shall be presented in a three ring binder that has tabbed sections as stated below. Provide all information in each section as stated below.
    - 1) 26 2400:
      - (a) Insert the approved submittals for the distribution panels and panelboards., as specified herein and/or indicated on the drawings.
      - (b) Provide the names, addresses and telephone numbers of the manufacturer and the two closest manufacturer's representatives of the equipment.
    - 2) 26 5101:
      - (a) Insert the approved submittals for the light fixtures.
      - (b) Highlight the lamp type that was installed for each light fixture.
      - (c) Provide the names, address and telephone numbers of the manufacturer and the closest manufacturer's representative for each light fixture.
    - 3) 26 5101:
      - (a) Insert the approved submittals for the motion sensing light control equipment.
      - (b) Insert all operating instructions.

- (c) Provide the names, address and telephone number of the manufacturer and the closest manufacturer's representative of the equipment.
- (d) Include the manufacturer's recommended maintenance of the equipment.
- 4) 26 5700:
  - (a) Insert the approved submittals for the low voltage lighting control equipment.
  - (b) Insert all operating instructions.
  - (c) Provide the names, address and telephone number of the manufacturer and the closest manufacturer's representative of the equipment.
  - (d) Include the manufacturer's recommended maintenance of the equipment.
- 5) 27 0000:
  - (a) Insert the approved submittals for the telecommunications system.
  - (b) Provide the names, address and telephone number of the manufacturer and the closest manufacturer's representative of the equipment.
  - (c) Include the manufacturer's recommended maintenance of the equipment.
- 6) 28 3101:
  - (a) Complete the "Record Of Completion" entirely.
  - (b) In the "Download File" indicate the exact equipment that the Monitor Modules are monitoring. i.e. fire sprinkler flow switches, tamper switches, etc..
  - (c) Simplify the Download File so that it coincides with the submitted and approved fire alarm single line diagram.
  - (d) Provide the names, address and telephone number of the manufacturer and the closest manufacturer's representative of the equipment.
  - (e) Include the manufacturer's recommended maintenance of the equipment.
  - (f) Insert an abbreviated data sheet that states how to test, reset and silence the fire alarm system.
  - (g) Insert the name and telephone number of the Central Station that receives the alarms, and the proper sequence to follow during an alarm.
- 7) 27 5101:
  - (a) Insert the approved submittals for the assisted listening system equipment.
  - (b) Insert all operating instructions.
  - (c) Provide the names, address and telephone numbers of the manufacturer, the closest manufacturer's representative of the equipment.
  - (d) Include the manufacturer's recommended maintenance of the equipment.
- 8) 27 5100:
  - (a) Insert the approved submittals for the IP clock and speaker system and equipment.
  - (b) Insert all operating instructions.
  - (c) Provide the names, address and telephone numbers of the manufacturer, the closest manufacturer's representative of the equipment and the telephone company contact.
  - (d) Include the manufacturer's recommended maintenance of the equipment including the UPS.
- 9) For all other systems specified herein and/or indicated on the drawings:
  - (a) Insert the approved submittals for each system.
  - (b) Insert all operating instructions for each system.
  - (c) Provide the names, address and telephone number of the manufacturer and the closest manufacturer's representative for each system.
  - (d) Include the manufacturer's recommended maintenance of each system.
- 10) 26 0800:



(a) Insert all systems testing results.

6. Record Documents: "As-builts": As specified under Paragraph 3.2 of this Section.

#### **1.07 DELIVERY, STORAGE AND HANDLING**

- A. Protection: Use all means necessary to protect the materials of this Section before, during, and after installation and to protect the work and materials of all trades.
- B. Delivery and Storage: Deliver all materials to the job site in their original containers with all labels intact and legible at time of use. Store in strict accordance with approved manufacturers' recommendations.
- C. Replacements: In the event of damage, immediately make all repairs and replacements necessary to the approval of the Architect and at no additional cost to the Owner.
- D. This Contractor shall personally, or through an authorized representative, check all materials upon receipt at jobsite for conformance with approved shop drawings and/or plans and specifications.

#### **1.08 SCHEDULING/SEQUENCING**

- A. Place orders for all equipment in time to prevent any delay in construction schedule or completion of project. If any materials or equipment are not ordered in time, additional charges made by equipment manufacturers to complete their equipment in time to meet the construction schedule, together with any special handling charges, shall be borne by this Contractor.
- B. The Contractor shall coordinate production and delivery schedule for all Owner-supplied equipment with the equipment suppliers to ensure that all Owner-supplied equipment is delivered to site in coordination with the construction schedule and in such a manner as to cause no delays in completion of the Contract as scheduled.

#### **1.09 REQUIREMENTS**

- A. The contract drawings indicate the extent and general arrangements of the conduit wiring systems, etc. If any departures from the contract drawings are deemed necessary by the Contractor, details of such departures and the reasons therefore shall be submitted as soon as practicable, and within thirty-five (35) days after award of the electrical contract.
- B. Unless material list and data is received as a complete and all-inclusive submittal within the stipulated time all items shall be provided as specified, with no deviations permitted.
- C. Any and all additional costs incurred by the substitution of electrical material or equipment, or installation thereof, whether architectural, structural, plumbing, mechanical or electrical, shall be borne by the Contractor under this Section.
- D. Burden of proof of equality of any substitution for a specified product is the responsibility of this Contractor.
- E. Where required by Architect to ascertain equality of substitute product, Contractor may be requested to provide the specified item and the submitted substitution for comparison, at no additional cost to the Owner.

#### **1.10 SEISMIC CERTIFICATION AND INSTALLATION OF EQUIPMENT**

- A. See Architectural and Structural Drawings and Specifications for description of Occupancy Group and Seismic Design Category applicable to this project.
- B. Provide Special Seismic Certification per CBC Section 1616A and ASCE/SEI 7-10 for all equipment and components defined as critical with an importance factor 1.5 in Paragraph 1.10.M.3 of this Section.

- C. Special Seismic Certification shall require either certification through approved analytical method or approved shake table testing in accordance with Section 13.2.5 of ASCE/SEI 7-10 or experience data in accordance with Section 13.2.6 of ASCE/SEI 7-10.
- D. Manufacturer's Seismic Certification or Project-Specific Design of Supports and Attachments for all other equipment and fixtures as per CBC Section 1616A and ASCE/SEI 7-10 requirements.
- E. Provide seismic restraints per applicable code and as specified or indicated. Design restraints to prevent permanent displacement in any direction caused by lateral motion, overturning, or uplift.
- F. Rigidly Supported Equipment, Conduits, and Raceways.
- G. Lighting:
  - 1. Fasten lighting fixtures in suspended ceilings to ceiling grid system or otherwise support from the structures as specified herein and as per details indicated on the Drawings. Comply with National Electric Code (NEC) Article 410.
  - 2. Suspension systems for light fixtures shall allow fixtures to swing a minimum of 45 degrees from the vertical in all directions without contacting obstructions.
  - 3. Free-swinging suspension systems shall have a safety wire or cable attached to the fixture and structure at each support. The wire shall be capable of supporting four times the weight of the lights.
  - 4. Point-source fixtures: provide slack wires to structure at two diagonal corners.
  - 5. Troffer fixtures: provide hold-down clip at each fixture corner, and slack wires to structure at two diagonal corners.
  - 6. Supports for pendants: Provide diagonal seismic wire restraints per Code.
- H. Components supported by chains or simply suspended from above are not required to meet lateral seismic force requirements and seismic relative displacement requirements provided that they cannot be damaged or cannot damage any other component when subject to seismic motion. They must have ductile or articulating connections to the structure at the point of attachment.
- I. Electrical Cabinets:
  - 1. Electrical cabinet design shall conform to National Electrical Manufacturers Association (NEMA) 250 and NEMA ICS6 standards. Cutouts in the lower shear panel that do not appear to have been made by the manufacturer and significantly reduce the strength of the cabinet are not permitted unless analysis demonstrates that the remaining strength is sufficient.
  - 2. Single freestanding cabinets shall have a minimum of four anchor bolts designed and specified with one anchor located at each corner.
  - 3. Multiple sections of cabinets or enclosures located adjacent to each other shall be bolted together. Minimum acceptable bolting is three bolts in the front and back along the adjacent vertical faces - 6 bolts total.
  - 4. Multiple cabinets bolted together to form a section or line-up shall have at a minimum two anchors specified for each cabinet, one at the front and one at the rear.
  - 5. Base anchorage shall be installed through anchor points designated by the Manufacturer. The largest bolt diameter for the anchor hole provided in the equipment shall be provided.
  - 6. A latch or fastener to prevent opening during an earthquake event and damaging the cabinet and internal components shall secure all doors.
  - 7. Slide-out components in electrical control panels, etc., shall have a latching mechanism to hold contents in place.

8. Attached cabling shall have adequate slack or flexibility between the cabinets and surrounding structure supporting the conduit to preclude severing of the cabling due to differential seismic displacements.
- J. The design load shall include the effects of loading on the equipment imposed by attached utility or service lines that are also attached to separate structures.
- K. The attachment of additional external items is not permitted unless such items have either been provided by the Manufacturer, or analysis shows that their effects are supported by design.
- L. Conduit and their connections shall be constructed of ductile materials unless otherwise approved by the Architect. Conduits and their connections constructed of non-ductile materials (e.g., cast iron, no-hub pipe and plastic) shall have brace lengths reduced to one-half that allowed for ductile material.
  1. All trapeze assemblies supporting conduit shall be braced to resist CBC design forces considering the total weight of the elements on the trapeze.
  2. Seismic restraint spacing shall be in accordance with hanger spacing.
- M. Critical Equipment:
  1. Design with importance factor of 1.5.
  2. Provide Special Seismic Certification for all equipment and components and their installation per CBC and ASCE/SEI requirements.
  3. Critical Equipment shall include the following:
    - a. Fire Alarm system equipment.
    - b. Central Emergency Lighting Inverter.
- N. Seismic Design Submittals: For all Critical Equipment included in paragraph 26 05 00.1.10.M.3.
  1. The Manufacturer of each item of critical equipment shall arrange for the testing or analysis by an approved agency of each component and assembly and its mounting system or anchorage.
  2. The Manufacturer shall submit a Certificate of Compliance for each item for approval by the Architect and by the Authority Having Jurisdiction.
  3. Based on Manufacturer's approved submittal, Contractor shall retain the services of a State of California registered Structural Engineer to prepare final installation details and drawings for equipment supports and attachments.
  4. Submit drawings of the equipment showing dimensions, support equipment, connections, and the proper anchorage locations.
  5. Equipment weight and weight distribution (e.g., center of gravity in elevation and plan).
  6. Thickness of sheet metal bases.
  7. Seismic Vibration Isolation Devices: Manufacturer's product information indicating class and type. Indicate load ratings as published manufacturer's data or shop drawings. Indicate proper orientation of devices on plan.
  8. Inertia bases and support frames.
  9. Specific details of restraints including anchor bolts and welds and maximum load at each location.
- O. Independent Supports: An independent means of secure support shall be provided for all wiring methods in non-fire-rated assemblies. Where independent support wires are used, they shall be distinguishable by color, tagging, or other effective means.

#### **1.11 DESCRIPTION OF DEMOLITION AND REPLACEMENT WORK**

- A. This project includes the demolition and replacement, modification, or enhancement of existing facilities. As such, the project scope for this contractor shall include all associated electrical, lighting, and signal system upgrades and demolition/removal work at the existing buildings(s) and/or site. The intent is that all systems will be complete and functional at the completion of this contract and that all old systems, equipment, feeders, circuits, wiring, and related devices

(no longer used) be completely and neatly removed. Where discrepancies between the drawings and existing conditions are noted, the Architect or Owner shall be notified immediately for resolution.

- B. As with every renovation project, the electrical work will include (and require) exploration and other field work on a daily basis to complete the new designed equipment and connections within the constraints of the existing building and existing site conditions.
- C. The contractor shall include as part of the base bid, sufficient labor hours to provide such exploration and field work throughout the duration of the project. Change orders for miscellaneous coordination of existing conditions will not be approved unless specific and latent conditions are uncovered that warrant such additional compensation or require additional work not shown on the drawings or included in the specifications, or implied by the designed conditions.
- D. New raceways and wiring to new and renovated equipment are to be installed unless otherwise noted. Where raceways are installed in accessible concealed locations (i.e. unfinished spaces or electrical / mechanical / attic spaces), EMT with wire shall be used. Where new wiring is required to be routed through existing walls and ceilings that cannot readily be accessible for new conduit, MC cable or flex conduit and wiring may be installed, fished through and secured in each space as required by Code. Non-metallic sheathed cable shall not be utilized on this project.
- E. All new raceways shall be installed concealed and all new equipment installed flush, unless otherwise noted on the drawings or in these specifications.

#### **1.12 GUARANTEE**

- A. This Contractor shall guarantee that all work executed under this Section will be free from defects of materials and workmanship for a period of one (1) year or as per the General Conditions of this project, whichever is longer. Dates shall be from the date of final acceptance of the building. The contractor shall further guarantee that he will, at his own expense, repair and replace all such defective work, and all other work damaged thereby, which becomes defective during the term of the guarantee. Such repair or replacement shall be guaranteed for one (1) year from the date of repair or replacement.

#### **1.13 PERMITS AND INSPECTIONS**

- A. This Contractor shall arrange for and obtain all required permits and inspections.
- B. Do not allow or cause any of the work to be covered or enclosed until it has been tested and/or inspected.

#### **1.14 IDENTIFICATION**

- A. Switchgear, switchboards, distribution panels, and feeder circuit breakers therein, panels, disconnect switches, motor starters, transformers, motor disconnect switches, cabinets, and other apparatus used for the operation of, or control of circuits, appliances or equipment, shall be properly identified by means of engraved laminated plastic descriptive nameplates mounted on apparatus using stainless steel screws. Nameplates shall have white letters with black background and be submitted to the Architect for approval. Cardholders in any form are not acceptable.
- B. Provide p-touch style labeling of circuit designations for all receptacles on the project.
- C. Each branch circuit of panel boards to have a permanently fixed number with load directory, mounted under celluloid on inside of cabinet door, showing circuit numbers and typewritten description of equipment supplied by breakers. Where changes are made to existing panelboards, newly typewritten circuit directories shall be prepared to replace existing directories.
- D. Provide label on all motors: "Caution. Automatic equipment. May start at any time."

- E. Provide silk-screened or engraved identification labels on all switch box covers identifying specific loads that are not readily apparent to the user, including electroshades, projection screens, exhaust fans, audio-visual controls, etc.. Submit proposed labels to Architect for approval prior to manufacture of labels.
- F. Provide identification of all pull boxes, junction boxes, and conduit stub-ups on the project as outlined below:
  - 1. For Power Feeders:
    - a. Stencil cover with identifying circuit number.
    - b. Lettering 1" high.
    - c. Color of lettering black.
    - d. Place lettering on cover in neat manner; run parallel to long sides of box.
  - 2. For branch circuits, grounding, communication, signal, and control systems boxes and blank conduit stub-outs:
    - a. Paint inside back of each j-box, front of each cover, and ends of each blank conduit stub-out with identifying system color as listed below:

1) 277/480-volt	Orange
2) 120/208-volt	Blue
3) Telephone/Data	Grey
4) Ground system	Green
5) Fire Alarm	Red
6) Lighting control	Orange/White
7) Clock/Speaker	Brown

## **PART 2 - PRODUCTS**

### **2.01 GENERAL**

- A. Refer to applicable Division 26, 27, and 28 Sections for complete products specifications.

### **2.02 MATERIALS**

- A. Materials of the same type or classification, used for the same purpose, shall be the product of the same manufacturer.

### **2.03 ACCEPTABLE MANUFACTURERS**

- A. Materials shall be of make mentioned elsewhere in this specification. All materials shall be the best of their several kinds, perfectly new and approved by the Underwriters' Laboratories.
- B. Where material, equipment, apparatus or other products are specified by manufacturer, brand name, type or catalog number, such designation is to establish standards of desired quality, style and utility and shall be the basis of the bid. Materials so specified shall be furnished under the contract unless changed by written approval of the Architect. Where two or more designations are listed, choice shall be optional with this Contractor, but this Contractor must submit his choice for final approval.

### **2.04 POSTED OPERATING INSTRUCTIONS**

- A. Furnish approved operating instructions for systems and equipment where indicated in the technical sections for use by operation and maintenance personnel. The operating instructions shall include wiring diagrams, control diagrams, and control sequence for each principal system and equipment. Print or engrave operating instructions and frame under glass or in approved laminated plastic. Post instructions as directed. Attach or post operating instructions adjacent to each principal system and equipment including startup, proper adjustment, operating, lubrication, shutdown, safety precautions, procedure in the event of equipment failure, and other items of instruction as recommended by the manufacturer of each system or equipment. Provide weather-resistant materials or weatherproof enclosures for operating

instruction exposed to the weather. Operating instruction shall not fade when exposed to sunlight and shall be secured to prevent easy removal or peeling.

## **2.05 CATALOGED PRODUCTS/SERVICE AVAILABILITY**

- A. Materials and equipment shall be current products by manufacturers regularly engaged in the production of such products. Products shall have been in satisfactory commercial or industrial use for 2 years prior to bid opening. The 2-year period shall include applications of equipment and materials under similar circumstances and of similar size. The 2-year period shall be satisfactorily completed by a product for sale on the commercial market through advertisements, manufacturers' catalogs, or brochures. Products having less than a 2-year field service record will be acceptable if a certified record of satisfactory field operation for not less than 6,000 hours, exclusive of the manufacturers' factory or laboratory tests, is furnished. The equipment items shall be supported by service organizations which are reasonable convenient to the equipment installation in order to render satisfactory service to the equipment on a regular and emergency basis during the warranty period of the contract.

## **PART 3 - EXECUTION**

### **3.01 INSPECTION**

- A. Examine the areas and conditions under which the work of this Section will be installed. Correct conditions detrimental to the proper and timely completion of the Work. Do not proceed until unsatisfactory conditions have been corrected.

### **3.02 PREPARATION**

- A. Drawings:
1. The general arrangement and location of wiring and equipment is shown on the electrical drawings and shall be installed in accordance therewith, except for minor changes required by conflict with the work of other trades.
  2. The Contractor shall coordinate and verify all backbox, device, lighting fixture, or equipment mounting requirements with the devices or equipment to be installed, prior to rough in.
  3. Drawings indicate the circuit and panel which supplies each device or fixture. Provide and install conduit and conductors to make all connections from panel to nearest device and from first device to additional devices on same circuit. Conduit size and fill shall satisfy NEC requirements. Two or three different phases supplied by a 3-phase panel may share a single neutral only if circuit positions are adjacent in the panel. Do not exceed 4 #12 or 3 #10 conductors in a 1/2" conduit, 7 #12 or 5 #10 in a 3/4" conduit, and 11 #12 or 9 #10 in a 1" conduit, unless otherwise noted. Provide common handle-tie on breakers for multi-wire branch circuits (with common neutral), per NEC. If more than three current carrying conductors are installed in one conduit, conductor size shall be increased as required per NEC. Do not share neutrals for branch circuit runs to electronic equipment or where noted on the drawings.
  4. Drawings indicate the location of all light switches. Where fixtures in a room are controlled by more than one switch, the same lower case letter is drawn adjacent to a switch and each fixture controlled by that switch. Where no lower case letter is adjacent to a switch, all fixtures in the room are controlled by that switch. Provide and install conduit and wire from fixture to switch and between fixtures as required to accomplish switching shown. Do not route branch circuit wiring for light fixtures through switch boxes. Where dimming controls are specified, provide required dimming control wiring in addition to power wiring from control device to all controlled light fixtures. Provide separate conduit for dimming control wiring unless otherwise indicated on the drawings.
  5. Drawings indicate location of all signal outlet boxes. Provide and install conduit system as required and complete system wiring, unless otherwise noted.

6. Control wiring is generally not shown on the plans. Contractor shall refer to control diagrams and provide and install all wiring and raceways required to make all interconnections.
  7. All branch circuit wiring No. 12 or No. 10 as noted, all control wiring No. 14, except as noted next to "slash marks" on the drawings, or as noted under "Wire," as specified herein.
  8. All dimensions, together with locations of doors, partitions, etc. are to be taken from the Architectural Drawings, verified at site by this Contractor.
  9. Maintain "as-built" records at all times, showing the exact location of concealed conduits and feeders installed under this contract, and actual numbering of each circuit. Upon completion of work and before acceptance can be considered, this Contractor must forward to the Architect, updated CAD plans, corrected to show the electrical work as actually installed.
  10. Branch circuit conductors shall be #12 minimum and #10 minimum for runs longer than 150 feet.
- B. Measurements: Before ordering any material or closing in any work, verify all measurements on the job. Any differences found between dimensions on the drawings and actual measurements shall be brought to the Architect's attention for consideration before proceeding.

### **3.03 FIELD QUALITY CONTROL**

- A. All workmanship shall be first class and carried out in a manner satisfactory to and approved by the Architect.
- B. This Contractor shall personally, or through an authorized and competent representative, constantly supervise the work and so far as possible keep the same foreman and workmen on the job throughout.

### **3.04 COORDINATION**

- A. In electrical rooms, where electrical equipment is located at walls with brace framing, provide and install steel channel supports for mounting of electrical equipment away from wall to avoid conflict with brace framing. Steel channel supports shall be unistrut or equal, and shall include all channels, bases, fittings, etc., as required for a complete installation.
- B. In electrical rooms, Contractor is responsible for installation of electrical equipment within the space provided. Contractor shall provide ¼" scale plans of electrical room layouts, and elevations of steel channel supports (where used or required) of electrical equipment for review and approval prior to any installation or rough-in

### **3.05 INSTALLATION/APPLICATION/ERECTION**

- A. All electrical raceways and devices shall be installed concealed (for raceways) and/or flush mounted (for devices), unless otherwise noted. Provide cut-in boxes and "fish" flexible MC or flex conduit and wire through existing walls to remain, unless shown otherwise on plans. Cut and patch to facilitate such installation to match adjacent and original finish.
- B. All cutting, repairing and structural reinforcing for the installation of this work shall be done by the General Contractor in conformance with the Architect's requirements.

### **3.06 EMERGENCY POWER SOURCES**

- A. All emergency source circuits shall be installed in separate raceways (from normal power), per 2017 NEC 700.10(B), or the applicable code at the time of permitting.

### **3.07 TEMPORARY LIGHTING AND POWER**

- A. Provide and install temporary lighting and power systems for the duration of construction, of adequate size to accommodate the required lighting and power loads. Coordinate with other trades to insure adequate sizing.
- B. Provide distribution equipment as required to support all construction activities.

### **3.08 FIRE STOPPING AND FIRE RATED PENETRATIONS**

- A. All electrical equipment mounted in, on, or through fire rated construction shall be installed to maintain the fire rating of the construction.
- B. Provide fire rated pads (or other suitable assembly) around all electrical junction boxes in fire rated walls/ceilings/floors to maintain the fire rating.
- C. Provide fire rated construction around all recessed light fixtures and/or panel board / cabinets mounted flush in fire rated walls to maintain the fire rating. Coordinate depth of construction with other trades to avoid conflicts.
- D. Conduit sleeves shall be provided as a means of routing cables through fire-rated walls or floors. Openings in sleeves and conduits used for system cables and those which remain (empty) spare shall be sealed with an approved fireproof, removable sagging material. Sleeves which pass vertically from floor to floor shall be sealed in a similar manner using an approved re-enterable system. Additional penetrations through rated assemblies necessary for passage of tel/data wiring shall be made using an approved method and permanently sealed after installation of cables.

### **3.09 ADJUSTING AND CLEANING**

- A. All electrical equipment, including existing equipment not "finish painted" under other sections, shall be touched up where finished surface is marred or damaged.
- B. All equipment, lighting fixtures, etc., shall be left in clean condition, with all shipping and otherwise unnecessary labels removed there from.

### **3.10 SCHEDULES**

- A. Coordination: Coordinate installation of electrical items with the schedule for other work to prevent unnecessary delays in the total Work.

### **3.11 WARNING SIGN MOUNTING**

- A. Provide the number of signs required to be readable from each accessible side, but space the signs a maximum of 30 feet apart.

### **3.12 PAINTING OF EQUIPMENT**

- A. Factory Applied: Electrical equipment shall have factory-applied painting systems which shall, as a minimum, meet the requirements of NEMA ICS 6 corrosion-resistance test, except equipment specified to meet requirements of ANSI C37.20 shall have a finish as specified in ANSI C37.20.
- B. Field Applied: Paint electrical equipment as required to match finish or meet safety criteria. Painting shall be as specified in the respective equipment section.

### **3.13 TESTS**

- A. Testing and inspection: See Section 26 08 00 - Testing.

**END OF SECTION**



## SECTION 26 0800

### TESTING

#### PART 1 - GENERAL

##### 1.01 WORK INCLUDED

- A. Work Included in This Section: All materials, labor, equipment, services, and incidentals necessary to perform the testing and inspection of the electrical work, including but not limited to the general systems noted below:
1. Grounding system.
  2. Lighting system.
  3. Distribution system.
  4. Fire Alarm system.
  5. Lighting control system.
  6. Lighting emergency inverter system.
  7. Telecommunications system.
  8. Title 24 Acceptance Testing.
  9. Test additional work where specified in other Sections of these specifications or where indicated on the drawings (provide all materials, labor, equipment, services, and incidentals necessary to perform the testing and inspection of this Electrical Work):
    - a. Clock/Speaker system.
    - b. Assisted Listening system.
  10. Any other electrical work as might reasonably be implied as required, even though not specifically mentioned herein or shown on the drawings.
  11. All work shall comply with Sections 26 05 00 and 26 27 00.
  12. In addition to the general system tests and inspections indicated above, the Contractor shall perform the following inspections and tests. The Contractor shall provide all material, equipment, labor, and technical supervision to perform such tests and inspections:
    - a. System Grounding.
    - b. Switchgear, Switchboards, Distribution Panels, Panelboards.
    - c. Feeders.
  13. The purpose of these tests is to assure that all tested electrical equipment is operational and within industry and manufacturer's tolerances and is installed in accordance with design specifications.

##### 1.02 APPLICABLE CODES, STANDARDS, AND REFERENCES

- A. All inspections and tests shall be in accordance with the International Electrical Testing Association - Acceptance Testing Specifications ATS-2017 (referred to herein as NETA ATS-2017).

##### 1.03 QUALIFICATIONS

- A. Qualifications of the Testing Firm shall be as listed in NETA ATS-2017.

#### PART 2 - PRODUCTS

##### 2.01 THIS ARTICLE DOES NOT APPLY TO TESTING.

#### PART 3 - EXECUTION

##### 3.01 GENERAL

- A. Final test and inspection to be conducted in presence of the Authority having Jurisdiction (AHJ) or Inspector of Record (IOR). Test shall be conducted at the expense of, and managed by, the Contractor, at a mutually agreed time. Submit written test report of all tests, with test result values and overall outcome.

- B. All portions of the electrical installation shall be inspected and tested to ensure safety to building occupants, operating personnel, conformity to code authorities and Contract Documents, and for proper system operation.

### 3.02 INSPECTIONS AND TESTS

- A. Tests: Field tests shall be performed and reports submitted, as per Section 26 05 00, Part 1.
  - 1. Final Inspection Certificates: Prior to final payment approval, deliver to the Owner, with a copy to the Architect, signed certificates of final inspection by the appropriate local authority having jurisdiction.
  - 2. Grounding System:
    - a. All ground connections shall be checked and the entire system shall be checked for continuity. The resistance of grounding electrodes in the system shall be measured using a 3 point fall-of-potential method. The maximum ground resistance shall be three ohms. If the measured ground resistance exceeds three ohms, install (1) additional ground rod, bonded and interconnected with the grounding electrode system.
    - b. Ground tests shall meet or exceed the requirements of the National Electric Code.
  - 3. Lighting Systems:
    - a. The interior and exterior lighting systems shall be checked for proper local controls and operation of entire installation, including the operation of the low voltage lighting control system.
  - 4. Power Distribution System:
    - a. Test main switchboard, distribution boards, panel boards, and transformers for grounds and shorts with mains disconnected from feeders, branch circuits connected and circuit breakers closed, all fixtures in place and permanently connected and grounding jumper to neutral lifted and with all wall switches closed.
    - b. Test each individual circuit at each panelboard with equipment connected for proper operation. Inspect the interior of each panel.
    - c. Check verification of color coding, tagging, numbering, and splice make-up.
    - d. Verify that all conductors associated with each circuit are in same conduit.
    - e. Demonstrate that all lights, jacks, switches, outlets, and equipment operate satisfactorily and as called for.
    - f. Perform megger tests of all new distribution system feeders prior to energizing. All Cables failing megger tests or with evidence of damage shall be removed and replaced in their entirety (no splices), at no cost to the Owner. Damaged cables may not be field repaired without specific approval of the Architect.
  - 5. Fire Alarm System: Verify that all equipment, components, and devices function as specified. Refer to Section 28 3101 for additional testing requirements.
  - 6. Clock/Speaker System: Verify that all equipment, components, and devices function as specified. Refer to Section 27 5100 for additional testing requirements.
  - 7. Lighting Control System: Verify that all equipment, components, and devices function as specified. Refer to Section 26 5101 for additional testing requirements.
  - 8. Telecommunications System: Verify that all equipment, components, and devices function as specified. Refer to Section 27 0000 for additional testing requirements.
  - 9. Where the following systems are specified herein and/or indicated on the drawings, verify that all equipment, components, and devices function as specified and meet all additional testing as described in related individual Sections of this specification:
    - a. Assisted Listening System.
- B. Title 24 Acceptance Testing: Contractor shall complete the requirements for Title 24 Acceptance Testing, as per CA Title 24, Part 6.

1. Perform testing requirements as per Title 24 Lighting Acceptance requirements. Testing shall include construction inspection of installed controls, occupancy / motion sensor testing, manual daylighting controls testing, automatic time switch controls testing, and demand response system interface, as applicable.
2. Complete and submit all required forms for complete Acceptance Testing.
3. Obtain required review and approval of Acceptance Forms to allow final certificate of occupancy to be granted.

**END OF SECTION**

**SECTION 26 2400**  
**SERVICE AND DISTRIBUTION SYSTEM**

**PART 1 - GENERAL**

**1.01 WORK INCLUDED**

- A. Work Included in This Section: All materials, labor, equipment, services and incidentals necessary to install the electrical work as shown on the drawings and as specified hereinafter, including but not limited to the work listed below.
- B. Underground service distribution conduits and conductors where noted for power and telecommunications services
- C. Temporary power for construction.
- D. Distribution Panels, Transformers, Distribution System, Panel Boards, Grounding, and Overcurrent Protective Devices.
- E. All required incidental work, such as excavating, backfilling, testing, and temporary power.
- F. Any other electrical work as might reasonably be implied as required, even though not specifically mentioned herein or shown on the drawings.
- G. All work shall comply with Sections 26 05 00 and 26 27 00.

**1.02 RELATED WORK**

- A. Division 09 - Finishes
- B. Division 23 - Heating, Ventilating, and Air Conditioning

**1.03 SUBMITTALS**

- A. Comply with the provisions of Section 26 05 00 - Submittals.

**PART 2 - PRODUCTS**

**2.01 ACCEPTABLE MANUFACTURERS**

- A. Refer to Section 26 05 00, Part 2 - Products
- B. All new equipment shall match existing.
- C. List of Equipment Manufacturers:
- D. Switchboards and Motor Control Centers
  - 1. Eaton-Cutler Hammer, General Electric, Industrial Electric Manufacturing, Schneider-Square D.
- E. Panelboards and Distribution Panel
  - 1. Same manufacturer as Main Switchboard.
- F. Dry-type Transformers
  - 1. Eaton-Cutler Hammer, Schneider-Square D, General Electric.

**2.02 MATERIALS**

- A. Grounding:
  - 1. Provide and install grounding system as noted on the drawings.
  - 2. Grounding electrode conductor: bare stranded copper type, #4/0 minimum.
  - 3. Install ground wires in rigid conduit.
  - 4. All grounding electrode conductor connections "thermite" or "cad-weld" welded.
  - 5. Use approved pressure type solderless connector or use fusion welding for all connections to and bonding of grounding electrode system. All connections shall be visible, readily accessible for testing purposes. Grounding electrode conductor between the grounding electrode and service equipment: Minimum #4/0.

6. Furnish and install solid copper or copper-clad 5/8" x 10'-0" ground rod(s). Where multiple ground rods are shown, install a minimum of 20'-0" apart. Install ground rods in accessible boxes with covers. Furnish and install 2-#4/0 bare copper cables between multiple ground rods and main switchboard ground bus.
  7. Terminate grounding conduits at equipment with ground bushing, with ground wire connected through bushing.
  8. Provide No. 12 stranded (green) THHN conductor from outlet box to ground screw of every receptacle.
  9. Ground all isolated sections of metallic raceways.
  10. Provide #12 minimum stranded (green) THHN conductor sized per NEC, or as noted, connected continuously throughout branch circuit for all circuits, bonded to panel ground bus, and to all electrical devices and equipment enclosures.
  11. Grounding electrode installed as follows:
    - a. Place #4/0 bare copper cable in foundation trench; tensioned, supported from vertical rebar in such a manner that it cannot be less than two (2) inches from bottom or side of concrete when foundation concrete is poured; not less than one hundred feet of conductor. Do not tie grounding conductor to horizontal rebar. Embed in foundation with a loop at approximate center, brought out at top of foundation at location of building service equipment for connection to service equipment and for bonding to other parts of the grounding electrode system.
    - b. Use approved pressure type solderless connector or use fusion welding for all connections to grounding electrode. Connection visible, readily accessible for testing purposes. Grounding electrode conductor between the grounding electrode and service equipment: Minimum #4/0.
    - c. Connect grounding electrode system to metallic water service entry metallic cold water pipe (if available) with nonferrous clamp and bare copper cable (sized as required) in conduit. Connection shall be accessible for inspection.
    - d. Connect grounding electrode system to effectively grounded building steel as indicated on the drawings. Use exothermic weld, connection shall be accessible for inspection.
    - e. After installation, test system using the three-point fall of potential method only. Record results and submit to Architect for approval. If resistance to ground exceeds three ohms, install an additional ground rod, bonded and interconnected to the grounding electrode system.
    - f. Connect ground bar of separately derived systems (e.g all dry-type transformers) to effectively grounded building steel at the closest possible accessible location, or if building is concrete, or the steel is not effectively grounded, to the main switchboard ground bus: Use #4/0 copper conductor for all connections.
- B. Distribution Panels:
1. General: Switchboard shall be group-mounted type, metal enclosure with ground bus and insulated full capacity neutral bus.
  2. Equipment:
    - a. The switchboard shall be braced for a short circuit current of 65,000 amps minimum, and for 100,000 amps when indicated on the drawings. Bracing shall be per NEMA and UL standards.
    - b. The switchboard shall comply with all the requirements of the Utility Company.
  3. The switchboard shall be pad or wall mounted, self-supporting, dead-front and rear, front-operated, front-connected, distribution type. Nema 1 (indoor) or Nema 3R (outdoor). The enclosure shall be 90 inches high, made of cold rolled steel on a structural shape, or formed, steel frame and shall be mounted on two 3-inch, 5-pound continuous channel iron sills, which shall be closed at the ends between the two channels.

4. This contractor is responsible for the complete installation of the switchboard within the space provided (both vertical and horizontal) and shall verify and/or coordinate all dimensions prior to ordering equipment. Proper allowances should be included to allow complete installation and erection.
5. The switchboard shall be a minimum of 24 inches deep and shall be constructed of National Electrical Code (NEC) gauge steel.
6. The switchboard shall be provided with a cable pull section at the top of the switchboard. Provide a minimum 12 inches of vertical clearance between the cable terminal lugs bolted to the switchboard busses and the top and bottom of the switchboard enclosure. Horizontal pull sections and gutters shall be kept free and clear of busses. Where busses cross vertical pull sections, the busses shall be insulated.
7. All connections between bus bars shall be of a bolted type using Belleville washers. Clamps will not be accepted. All bus bars shall be accurately formed, and all holes shall be made in a manner which will permit bus bars and connections to be fitted into place without being forced.
8. The design of all current-carrying devices or parts of the switchboard shall conform to the standard specified in the related sections of Underwriters' Laboratories, Inc. (UL) No. UL-891 and National Electric Manufacturer's Association (NEMA) Standard PB-2, except as these characteristics may be modified herein.
9. Bus bars, connection bars and wiring on the back of the switchboard shall be arranged so that maximum accessibility is provided for cable connections from the front.
10. Ampere ratings for rectangular bus bars shall be in accordance with the temperature rise standard of National Electric Manufacturer's Association (NEMA) and the Underwriters' Laboratories, Inc. (UL).
11. The enclosure shall be chemically cleaned by parkerizing, bonderizing or phosporizing as a unit after all welding has been completed. The enclosure shall then be painted with a rust-resisting primer coat of paint and shall be finished with a coat of light gray, baked enamel.
12. Each section shall be bussed for the full connected load of that section. Extend bussing to spare circuit breaker "Spaces." Drill busses for future circuit breakers, and provide breaker connector hardware where indicated on the drawings or where required for ready installation of future circuit breakers.
13. Provide copper bus bars and connections with silver-plated contact surfaces.
14. The contact surfaces and studs of all devices to which bus connections are made shall also have silver-plated surfaces.
15. Locate ground bus, with a cross-section equal to at least 25 percent of the capacity of the main bus rating, in the back of the switchboard and extend bus throughout the length of the switchboard assembly. Ground each housing of the assembly directly to this bus.
16. Rigidly support all bus and connection bars and current transformers.
17. Fit all nuts and connections with locking devices to prevent loosening.
18. Provide load connections with solderless lugs. Factory-install all devices shown on Drawings as specified herein.
19. Provide ground fault protection for all main breakers or feeder breakers rated at 1000A or higher at 277/480V 3PH, and when otherwise indicated on the single line diagram or where otherwise noted on the drawings. Protection shall consist of a current sensor, relaying device, and the appropriately sized overcurrent protection device.
20. Provide a bonding strap from the equipment ground bus to the neutral bus.
21. Provide transient voltage surge protection, integral to or adjacent to the switchboard when indicated on the plans or where otherwise noted in the specifications herein. Refer to Section 26 43 00.

22. Distribution Panels shall comply with all relevant requirements of the above paragraphs - minimum 12" deep, for floor or wall-mounting.
- C. Panelboards:
1. Surface (or flush where indicated on the drawings) mounted, with branch circuits as indicated on the drawings.
  2. Enclosures: code gauge galvanized sheet steel with welded full flange end pieces, stretcher- leveled steel trim, backpan and door.
  3. Bussing of copper with silver-plated contact surfaces.
  4. Provide a 200% rated neutral bus for panels supplied with 200% rated feeders (incoming or outgoing). Refer to single line riser diagram for feeder ratings.
  5. Properly identify the "high leg" of 4-wire delta connected systems as required by NEC 384-3(e).
  6. Trims on surface-mounted cabinets secured with nickel-plated screws with cup washers, bottom of all trims to have lugs for resting on cabinet flange.
  7. Panels shall be 20 inches minimum in width, provided with approved gutter space, barriers and adjustable supports. Doors mounted with concealed hinges provided with combination spring latch and lock. Doors and trims and surface mounted cabinets primed and finished with one coat baked on gray enamel. All visible panel enclosures and covers in finished (occupied) areas shall be painted to match adjacent wall finish.
  8. Breakers on same phase to be aligned horizontally. Each panel provided with quantity (5) spare handle locks. Install handle locks on all breakers serving fire alarm equipment.
  9. Each branch circuit of panelboards to have a permanently fixed number with one word directory, mounted under celluloid on inside of cabinet door, showing circuit numbers and typewritten description of outlets controlled by breakers. Color code mains and each breaker terminal, same as conductor insulation.
  10. Each panel shall be equipped with a copper ground bus.
  11. All panels shall be fully bussed to accept future circuit breakers, with breaker hardware provided where indicated on the drawings.
  12. Panel board submittals shall include diagrams of the circuit breaker arrangements in the panels. Arrange circuit breakers in panels exactly as shown on the panel schedules in the construction documents - no deviations permitted.
- D. Circuit Breakers:
1. General: Circuit breakers shall be molded case rated for 480 or 240 volts, multiple or single pole and amperage rating as shown on the drawings, bolt on, manually operated with "de-ion" arc chutes.
  2. Main circuit breaker shall be shall be rated to interrupt the available short circuit current - 65,000 amps RMS unless otherwise indicated on the drawings.
  3. Distribution circuit breakers shall be rated for the amps interrupting capacity noted on the drawings or U.L. series rated with the main circuit breaker.
  4. Branch circuit breakers shall be rated for the amps interrupting capacity or U.L. series rated with the distribution and main circuit breakers, General Electric type THQB or equal, minimum 10,000 A.I.C for 120/208 volt; type TEY or equal, minimum 14,000 A.I.C for 277/480 volt.
  5. Where mechanical equipment is U.L. listed for overcurrent protection with fuses or HACR type circuit breakers, provide fuses where a fused switch is shown. Where the overcurrent protection is a circuit breaker provide HACR, (Heating, Air-Conditioning and Refrigeration) type.
  6. Provide switch rated type "SWD" circuit breakers were the circuit breaker is used as a switching device in a panelboard.
- E. Dry-Type Transformers:

1. Ventilated type.
  2. Dry-type general distribution transformers shall meet the California Title 24 requirements for energy efficiency standards and DOE 10 - CFR, Part 431 (2019) for energy efficient transformers.
  3. Transformer shall be 3 phase, 60 Hertz. Primary winding shall be Delta connected and secondary winding shall be Wye connected. The temperature rise at rated voltage and full load shall not exceed 150 degrees C with a 220 degrees C U.L. Component Recognized Insulation System. The windings shall be aluminum or copper.
  4. The higher voltage winding shall have quantity (6) 2.5% taps - (2) FCAN and (4) FCBN. Set secondary voltage for 120/208V.
  5. Transformer terminals shall be front connected for ease of installation and maintenance.
  6. Where the transformers are installed outdoors provide weatherproof drip cover, rodent screen and a weathertight rating of the enclosure.
- F. Magnetic starters: shall be rated in accordance with latest published NEMA standards for size and horsepower rating, Eaton-Cutler Hammer A-200 series or equal. Provide with overload sensor in each phase, hand-off-auto switch, red "run" pilotlight, in NEMA 1, NEMA 4X, or NEMA 3R enclosure or in motor control center where indicated. Coil shall be rated 120 VAC. Starters shall be across-the-line nonreversing unless otherwise noted.
1. Contacts: Across-the-line magnetic starters shall be equipped with double break silver alloy contacts. All contacts shall be replaceable without removing power wiring or removing starter from panel. The starter must have straight-through wiring.
  2. Coils: Coils shall be of molded construction. All coils shall be replaceable from the front without removing the starter from the panel.
  3. Overload Relays and Thermal Units: Overload relays shall be the melting alloy type with a replaceable control circuit module. Thermal units shall be of one-piece construction and interchangeable. The starter shall be inoperative if the thermal unit is removed.

### **PART 3 - EXECUTION**

#### **3.01 REFER TO SECTION 26 05 00 FOR DETAILS OF WORK UNDER THIS SECTION.**

#### **3.02 INSTALLATION/APPLICATION/ERECTION**

- A. Excavate and trench as necessary for the electrical installation, and when the work has been installed, inspected and approved, backfill all excavations with clean earth from excavation, or imported sandy soil in maximum 8" (eight-inch) layers, moisten and machine tamp to 95% compaction, and restore the ground and/or paving or floor surfaces to their original condition.
- B. Switchboards and Distribution Panels Installation: Mount as detailed on the drawings.
- C. Motor Connections:
1. Install motor circuits complete for all motors by other trades
  2. Furnish and install all disconnect switches, outlet boxes, etc., as required by code.
  3. All motor and temperature control low voltage wiring shall be installed and connected by Division 23 Section of specifications, unless otherwise indicated on electrical drawings.
- D. Motor Starters Installation:
1. Deliver starters to site without thermal overload elements. Determine nameplate rating of each motor, after motor and starter installation, select thermal element rating from measured motor running current and install proper elements in starters.
    - a. Submit chart denoting motor designation, motor H.P., motor running current (N.P.), actual running current fuse/breaker size and thermal element catalog number. Take readings of motor running currents in conjunction with Division 23 - Heating, Ventilating, and Air Conditioning.



**3.03 TESTS**

A. Testing and Inspection: See Section 26 08 00 - Testing.

**END OF SECTION**

**SECTION 26 2700**  
**BASIC ELECTRICAL MATERIALS AND METHODS**

**PART 1 - GENERAL**

**1.01 WORK INCLUDED**

- A. Work included in this Section: All materials, labor, equipment, services, and incidentals necessary to install the electrical work as shown on the drawings and as specified hereinafter, including but not limited to the work listed below:
  - 1. Raceways, feeders, branch circuit wiring, wiring devices, safety switches and connections to all equipment requiring electric service.
- B. Any other electrical work as might reasonably be implied as required, even though not specifically mentioned herein or shown on the drawings.
- C. All work shall comply with Section 26 05 00.

**1.02 RELATED WORK**

- A. Division 09 - Finishes
- B. Division 23 - Motors and Mechanical Equipment Installation

**1.03 SUBMITTALS**

- A. Comply with the provisions of Section 26 05 00.

**PART 2 - PRODUCTS**

**2.01 ACCEPTABLE MANUFACTURERS**

- A. Refer to Section 26 05 00, Basic Electrical Requirements, Part 2 - Products.
- B. List of Equipment Manufacturers:
- C. Conduit and Conduit Fittings
  - 1. Allied Tube and Conduit, Wester Tube and Conduit, LTV Steel Tubular, National Electric Products, AFC, Republic Steel Corporation, Rome Cable Corporation, United States Steel Corporation, Killark Electric Manufacturing Company, Racor, VAW Aluminum Company, Bridgeport, Steel City, Thomas & Betts, Carlon, O.Z. Gedney, Appleton, Regal.
- D. Wire and Cable (600V)
  - 1. American Wire Company, General Wire and Cable Corporation, Okonite Company, Rome Cable Corporation, Cerrowire, American Insulated Wire, AFC Cable Systems, Essex, Simplex Wire and Cable Company, Southwire.
- E. Solderless Lugs and Grounding Connections
  - 1. Burndy Engineering Company Inc, O.Z. Gedney Company Inc, Penn Union Electric Corporation, Thomas and Betts Company Inc.
- F. Pull Boxes, Gutters, Special Cabinets
  - 1. Schneider-Square D Company, Columbia Electric Manufacturing Company, General Electric Company, Eaton Inc.
- G. Outlet Boxes
  - 1. Appleton Electric Company, Killark Electric Manufacturing Company, Lew Electric Fittings Company, National Electric Products Corporation, Racor, Steel City Electric Company, Carlon, Bowers.
- H. Floor Boxes
  - 1. Steel City Electric Company, Hubbell Inc, RCI, Walker.
- I. Wiring Devices
  - 1. Leviton, Arrow-Hart, Cooper, Hubbell, Lutron, Bryant.

- J. Conduit Racks, Hangers
  - 1. General Electric Company, Killark Electric Manufacturing Company, Caddy, National Electric Products Corporation, Republic Steel Corporation, Rome Cable Corporation, United States Steel Corporation, VAW Aluminum Company, Superstrut, B-Line.
- K. Safety Switches (Disconnect and Fusible)
  - 1. Schneider-Square D Company, Eaton-Cutler Hammer Inc, General Electric Company.
- L. Fuses
  - 1. Bussman Manufacturing Company, Chase-Shawmut Company.
- M. Firestopping
  - 1. 3M, Nelson.

## 2.02 MATERIALS

- A. Raceways: Only the raceways specified below shall be utilized on this project. Substitutions shall be pre-approved in writing. All bare conduit ends (stub-ups or stub-outs) shall be provided with bushed ends or manufactured insulated throat connectors:
  - 1. Rigid Type - hot dip galvanized or sherardized steel, use on all exterior locations, below grade or in concrete slab, and to 18" on either side of structural expansion joints in floor slabs, with completely watertight, threaded fittings throughout. Compression fittings are not acceptable.
    - a. All rigid steel conduit couplings and elbows in soil or concrete or under membrane to be ½ lap wrapped with Scotch #50 tape and threaded ends coated with T&B #S.C.40 rust inhibitor prior to installation of couplings.
    - b. ½ lap wrap all rigid steel conduit stub-ups from slab or grade to 6" above finished grade level with Scotch #50 tape.
  - 2. In lieu of rigid steel conduit for power and control raceways and branch circuit conduits in soil or concrete slabs, "Schedule 40" PVC with Schedule 80 PVC conduit elbows and stub-ups may be used with code size (minimum No. 12) ground wire. A "stub-up" is considered to terminate 6" above the finished surface.
    - a. Schedule 80 PVC conduit shall be used in all concrete footings or foundations and to 18" of either side of footings or foundation walls.
    - b. Schedule 80 PVC conduit shall be used in all concrete masonry unit (CMU) walls or columns.
    - c. All conduit runs in concrete floor slabs (where allowed) shall be installed to comply with all applicable CBC and structural codes to maintain the structural integrity of the floor slab. Where conflicts occur, alternate routing shall be provided at no additional cost to the Owner.
    - d. Where schedule 80 PVC is coupled to schedule 40 or other raceways with differing interior dimensions, each end shall be reamed with a reaming tool to reduce the edge profile for protection of the passing conductors during the pull.
  - 3. Intermediate metal conduit may be used in all exposed interior locations, except that electrical metallic tubing may be used in some locations as noted below. Utilize steel compression type fittings for all exposed conduit runs, unless otherwise noted. Cast fittings are unacceptable.
  - 4. Electrical metallic tubing shall be used exposed in interior electrical and mechanical rooms, in interior unfinished spaces, and in interior concealed and furred spaces, made up with steel watertight or steel set screw type fittings and couplings. EMT shall not be used in under-building crawl spaces or other areas subject to moisture. Set screws shall have hardened points. Cast fittings are unacceptable.
  - 5. Surface mounted rectangular steel raceways and boxes: use for all surface mounted installations, unless otherwise noted (all catalog numbers listed are Wiremold - equals allowed) - color Ivory, unless otherwise noted;

26 2700 - BASIC ELECTRICAL MATERIALS AND

- a. #V500 for branch power runs on ceilings and walls (used with V500 series straps, elbows, connectors and V5000 series low profile boxes and covers).
  - b. #2000 or 2400 low profile for larger power run requirements on ceiling or walls (used with V2000 series straps, elbows, connectors and low profile boxes and covers).
  - c. #2400D for dual service power and tel/data run requirements (used with divided V2400 boxes and covers).
6. Surface mounted rectangular non-metallic dual service raceways; Wiremold #5400 (Ivory) or equal with all required compatible activation covers, bezels, inserts, and blank plates for a complete installation. Refer to drawings for outlet quantities in raceway and feed points. All raceway fed flush from rear with horizontal j-boxes, unless otherwise noted.
  7. Use flexible conduit for all motor, transformer and recessed fixture connections, minimum ½"; "Seal tite" type used outdoors and in all wet locations, provide with code size (minimum No. 12) bare ground wire in all flexible conduit.
  8. All conduit cuts (factory or field cut) shall be perfectly square to the length of the conduit and cut ends shall be reamed with a reaming tool to provide a smooth edge to the passing conductors and to remove all burs and scrapes. Use of a hand file is not acceptable.
  9. All electrical raceways shall be installed concealed, unless otherwise noted. Cut and patch to facilitate such installation to match adjacent and original finish. All exposed conduits, where required, shall be installed parallel to building members.
  10. All emergency source circuits shall be installed in separate raceways (from normal power), per 2017 NEC 700.10(B), or the applicable code at the time of permitting.
  11. Where existing conditions preclude the installation of EMT in existing walls to remain, provide and install cut-in type boxes and "fish" flexible MC or flex conduit and wire through existing walls to remain, unless shown otherwise on plans.
  12. Fasten conduits securely to boxes with locknuts and bushings to provide good electrical continuity.
  13. Provide chrome escutcheon plates at all exposed wall, ceiling and floor conduit penetrations.
  14. Support individual suspended conduits with heavy malleable strap or rod hangers; supports for ½ inch or ¾ inch conduit placed on maximum 7-foot centers; maximum 10-foot centers on conduits 1 inch or larger.
  15. Support multiple conduit runs from Kindorf B907 channels with C-105 and C-106 straps.
  16. Conduit bends - long radius.
  17. Flash conduits through roof, using approved roof jack; coordinate with General Contractor.
  18. To facilitate pulling of feeder conductors, install junction boxes as shown or required.
  19. All empty conduits on the project shall be provided with a nylon pull rope to allow pulling of future conductors intended for the specific raceway. Provide plastic wire-tie style nameplate tags on each end of pull rope with printed identification of conduit use and the location of the opposite end of the rope. Pull ropes for telecommunications service conduits shall meet the utility company requirements.
  20. Where conduits pass through structural expansion joints in floor slab, rigid galvanized conduit shall be used 18" on either side of joint, complete with Appleton expansion couplings and bonding jumpers, or equal. All above grade expansion joint crossings shall also utilize expansion joint couplings or flex conduit transitions as required for each particular installation. Installed condition shall allow for a minimum deflection of raceway and wire (in any direction) equal to the structural expansion joint dimension (building to building). No solid conduits shall be allowed to cross expansion joints without proper provisions for building and seismic movement.
  21. Minimum cover of conduits in ground outside of building - 36 inches, unless otherwise noted.

22. Provide and install exterior wall conduit seals and cable seals in the locations listed below. Coordinate installation and scheduling with other trades:
  - a. Conduit seals through exterior wall or slab (below grade): O.Z. Gedney series "FSK" in new cast in concrete locations, series "CSM" in cored locations.
  - b. Conduit seals through exterior wall or slab (above grade): O.Z. Gedney series "CSMI."
  - c. Cable seals at first interior conduit termination after entry through exterior wall or slab: O.Z. Gedney series "CSBI." Coordinate quantity of conductors at each location.
- B. Outlet Boxes and Junction Boxes. Verify all backbox requirements with devices to be installed prior to rough-in.
  1. One piece steel knockout type drawn boxes, unless otherwise noted, sized as required for conditions at each outlet or as noted.
  2. Flush-mounted boxes equipped with galvanized steel raised covers for device mounting flush with finished surface. Provide extension rings as required on all acoustical or additional wall treatment areas to bring top of cover flush with finished surface (coordinate with architectural drawings). Devices shall be capable of being tightly mounted to boxes without distorting or bending device or mounting hardware.
  3. Boxes for fixture outlets: 4-inch octagon or larger as required, or as noted.
  4. Switch and receptacle outlets - not smaller than 4-inch-square in furred walls, with raised cover for single device; ganged where required.
  5. Outlet and switch boxes for wet locations, cast aluminum FS or FD type with cast aluminum gasketed spring lid cover. Weatherproof "Bell" type boxes are not acceptable.
  6. All connectors from conduit to junction or outlet boxes shall have insulated throats. Connectors shall be manufactured with insulated throats as integral part. Insertable insulated throats are unacceptable.
  7. Outlet boxes for telecommunications, 4" square or larger as required or noted, multi-ganged for voice, data, and other services where indicated on the drawings.
  8. Conduit Bodies: Malleable iron type, with lubricated spring steel clips over edge of conduit body, O-Z/Gedney type EW, or equal.
  9. Floor Boxes:
    - a. Classification and Use: Floor boxes shall have been examined and tested by Underwriters Laboratories Inc. to meet UL514A and Canadian Standard C22.2 and shall bear the appropriate label. Floor boxes shall conform to the standard set in the National Electrical Code. Multi-compartment boxes shall have been evaluated by UL to meet the applicable U.S. and Canadian safety standards for scrub water exclusion when used on tile, terrazzo, wood, and carpet covered floors.
    - b. Floor boxes shall provide flush or recessed device outlets that will not obstruct the floor area. Refer to Drawings for size and types. This specification covers concrete and wood frame floor applications with Wiremold 800, 860 and 880 and RFB Series boxes.
    - c. Cast-Iron Boxes: Box interior and exterior shall be painted. Boxes shall be available in 1,2, and 3 gang configurations. Boxes shall also be available in deep and shallow versions. Box shall provide 1-3/4 inches of pre-pour adjustment and 1/2 inch of post-pour adjustment.
    - d. Steel Boxes: Boxes shall be manufactured from stamped steel and formed. Boxes shall be available in 1,2, and 3 gang configurations. Boxes shall also be available in deep and shallow versions. All stamped steel versions shall provide 1-3/4 inches of pre-pour adjustment and 1/2 inch of post-pour adjustment.
    - e. Nonmetallic Multi-service Floor Boxes: Boxes shall be manufactured through the use of injection molded Geon M3900 PVC material. The box shall be rectangular in shape. Boxes shall allow for ganging of boxes together through a dovetail interlocking

mechanism. Knockouts shall be provided on the side walls of each box to provide for pass-through capability between each gang. Boxes shall also have concrete depth markings on the exterior of the box to indicate box depth at the time of the pour. Boxes shall also provide graduated cubic inch markings on the interior of the box to indicate volume capacity at the appropriate box depth. Box shall accommodate concrete depths from 3-1/2 inches minimum to 6 inches maximum.

- 1) Floor boxes shall provide (2) 1-1/4 inch conduit openings to feed cabling to the box. Boxes shall provide the means to reduce this opening to fit 1 inch, 3/4 inch and 1/2 inch conduit sizes. Box shall be equipped with a high impact mudcap to protect the box from damage and prevent concrete entry during the pour and debris entry after the pour. Box shall also provide ratchet teeth along interior box walls to attach cover. Box shall include internal spacer to prevent deformation of the box sidewalls when high temperature additives are used in the concrete pour.
  - 2) Adjusting rings shall be used to attach flanges and covers to the floor box body. Adjusting ring shall have ratchet teeth to align with the teeth on box wall to connect box body without the use of adhesive or mechanical fasteners. Adjusting ring shall provide for 10 degrees of adjustment after concrete pour to adjust to various concrete conditions and floor finishes. Provide brass inserts to mount finish flanges to box body. Adjusting ring shall also provide for grounding locations using brass inserts.
  - 3) Adjusting ring shall provide the ability to accept a modular connectivity system. Modular communication inserts shall snap directly into the adjusting ring openings. Adjusting ring shall provide a fiber storage loop to maintain proper fiber optic bend radius control and excess fiber storage. Each adjusting ring shall except up to six connectivity activation locations. Adjusting ring shall allow modular connectivity inserts to be mounted recessed and protected when not in use.
- f. Covers and Flanges:
- 1) Floor box options shall accept aluminum, brass and nonmetallic cover plates and flanges.
  - 2) Flanges shall be available in one-, two-, and three-gang applications. Each flange shall provide 1/2 inches of adjustment to accommodate various floor coverings and concrete depths.
  - 3) Flanges shall accommodate connectivity outlets and modular inserts.
  - 4) Modular inserts shall snap directly into each flange using a mounting bezel.
- g. Multi-Compartment Boxes:
- 1) Boxes shall be fully adjustable, providing a maximum of 1-7/8 (RFB4) 2" (RFB9/RFB11) inch pre-pour adjustment, and a maximum of 3/4 inch post-pour adjustment.
  - 2) Boxes shall provide a series of device mounting plates that will accept both duplex power devices, as well as plates that will accommodate connectivity and AV outlets with modular inserts.
  - 3) The box shall provide 3/4", 1" and 1 1/4" conduit size openings with 2" KO for larger size boxes.
  - 4) Cover shall be cast aluminum. Lid shall be offered with solid, flush surface for tile, wood or terrazzo and an insert option for carpet inlay.
  - 5) Cover options shall support loads from 390LBS to 3000LBS
  - 6) Use cast iron boxes for on-grade applications (RFB4-CI-1). Stamped steel allowed for above grade applications (RFB-4 and RFB-4DB).
10. Pull boxes: All site pull boxes shall be flush in-ground concrete, with engraved covers identifying service use (i.e. electrical, communications, etc.). Boxes shall be Nema 250,

Type 6, outside flanged, with recessed cover for flush mounting, by Christy or equal, with required depth to provide box and conduit depths shown or required.

- a. Provide concrete covers for all boxes in planted or paved areas (up to available concrete cover size).
  - b. Provide galvanized steel covers for all larger boxes (when concrete is not available), or in traffic areas. No cast iron covers.
  - c. Provide bolted covers and slab bottoms (with grouted perimeter) or vault type boxes for all electrical distribution and signal system pull boxes used for site distribution, to prevent rodent entry. No collar type boxes with dirt or gravel bottoms
  - d. Provide drain hole at bottom of all vault type boxes, with loose aggregate base below, for proper drainage.
  - e. All covers to be completely flush with finished adjacent surfaces.
  - f. Provide galvanized steel H20 rated covers and installation of box rated for H20 in all traffic areas.
  - g. Provide pullboxes per utility company specifications for all electrical primary and secondary services and for telecommunications service runs. Verify exact size and type prior to order with each utility company.
- C. Wire and Cable (line voltage and signal systems):
1. 600-volt class where used for or run with line voltage power wiring, insulation color coded, minimum No. 12 AWG for power branch circuits, No. 14 for power control circuits, and wiring size and type as directed by signal system manufacturer for each signal system.
  2. All conductors shall be copper.
  3. Size and insulation type:
    - a. Standard locations: #12 to #1 AWG: THWN for wet locations and THHN for dry locations. #1/0 through #4/0 AWG: XHHW (55 Mils). 250MCM and larger: XHHW (65 Mils). All wire sizes used shall be based on a 75 degree insulation rating, unless specifically used with 90 degree rated breakers and devices.
    - b. All wiring (power and signal) installed underground between buildings, or in wet or damp locations, shall be outside listed and rated for wet locations.
    - c. High temperature and non-standard locations: Provide wire type and insulation category suitable for area of use as defined in NEC table 310-13.
  4. Conductors No. 8 and larger and as otherwise noted on drawings shall be stranded. Power conductors No. 12 and No. 10 shall be solid or stranded. Power conductors No. 14 or smaller shall be solid.
  5. Provide signal system wiring for each system to meet the system manufacturers requirements and recommendations for each device or equipment type. Signal wiring systems shall be provided with shielding and/or insulation type and cable quantities as directed by the manufacturer, and meet all NEC requirements for locations used.
  6. Install all wiring branch circuits and feeders (low voltage and line voltage) in conduit unless noted otherwise on the drawings. Contractor shall mandrel all feeders and pass a "sock" (or utilize other suitable means) through each raceway prior to pull to remove all water and construction debris. All raceways shall be completely clear of any obstructions or debris and all cut ends shall be reamed, prior to pull. Utilize pulling compound on all runs to insure minimum friction and pulling tension.
  7. Megger test all feeders prior to energizing. See section 26 08 00 for additional information.
  8. Approximately balance branch circuits about the neutral conductors in panels.
  9. Connections to devices from "thru-feed" branch circuit conductors to be made with pigtails, with no interruption of the branch circuit conductors.

10. Neutral conductor identified by white outer braid, with different tracers of "EZ" numbering tags used where more than one neutral conductor is contained in a single raceway.
  11. Neatly arrange and "marlin" wires in panels and distribution panelboards with "T and B Ty-rap" or approved equal plastic type strapping.
  12. All wire and cable shall bear the Underwriters' Label, brought to the job in unbroken packages; wire color-coded as follows:

a. Voltage	Phasing	A	B	C	N
b. 120/208	3PH4W	Black	Red	Blue	White
c. 2083PH	3W	Black	Red	Blue	--
d. 277/480	3PH4W	Brown	Orange	Yellow	White
e. 4803PH	3W	Brown	Orange	Yellow	--
  13. The equipment grounding conductor shall be insulated copper; where it is insulated, the insulation shall be colored green.
  14. Label each wire of each electrical system in each pull box, junction box, outlet box, terminal cabinet, and panelboard in which it appears with "EZ" numbering tags indicating the connected circuit numbers.
  15. Provide permanently affixed adhesive labels with machine printed lettering (min. 1/8" high) at junction boxes serving fixtures that are supplied by (2) electrical sources (i.e. normal and emergency lighting). Label to read "CAUTION - This light fixture is powered by (2) separate sources. The normal power source breaker and the emergency power source breaker must be turned off before servicing this light fixture."
  16. Install feeder cables in one continuous section unless splices are approved by Architect. Exercise care in pulling to avoid damage or disarrangement of conductors, using approved grips. No cable shall be bent to smaller radius than the spool on which it was delivered from the manufacturer. Color code feeder cables at terminals. Provide identifying linen tags in each pullbox.
- D. Switches: Model numbers are Hubbell, color to be selected by architect, unless otherwise noted. All switches to utilize screw terminals for wire connections - no plug-in terminations:
1. Single Pole - No. HBL1221
  2. Two Pole - No. HBL1222
  3. Three Way - No. HBL1223
  4. Momentary contact - No. HBL1557
  5. Momentary contact Keyed - No. HBL1556L
  6. Keyed, - No. HBL1221L
  7. Pilot Light (on with load on) - Hubbell No. 1221-PLC
  8. Motor Rated Double Pole (30A) - Hubbell No. 7832
  9. Motor Rated Three Pole (30A) - Hubbell No. 7810.
  10. Low voltage Data line switches - Refer to lighting control system (for compatibility)
- E. Receptacles: Mounting straps and contacts shall be one piece design, constructed of minimum .050" solid brass. Base shall be high strength, heat resistant, glass reinforced nylon. Device shall accept up to #10 wire, side or back wired with screw terminals - no plug-in terminations. Hubbell, Leviton, Pass & Seymore, or equal. Color to be selected by architect, unless otherwise noted. Numbers listed below are Hubbell:
1. 15A 3PG 125 volt duplex - No. HBL5262
  2. 20A 3PG 125 volt duplex - No. HBL5362
  3. 20A 3PG 125 volt ground fault interrupter receptacle; GFI receptacles shall conform to the 2006 UL requirements to a) interrupt power to the unit in the event of internal failure, or b) provide an audible or visual indication of internal failure of the GFI; No. GF20 or equal. Through wiring to down stream GFI designated receptacles is not acceptable.



4. 15A 3PG 125 volt half controlled duplex receptacle - No. BR15C1(color), with permanent "controlled" marking, factory applied.
  5. 20A 3PG 125 volt half controlled duplex receptacle - No. BR20C1(color), with permanent "controlled" marking, factory applied.
  6. 15A 3PG 125 volt full controlled duplex receptacle - No. BR15C2(color), with permanent "controlled" marking, factory applied.
  7. 20A 3PG 125 volt full controlled duplex receptacle - No. BR20C2(color), with permanent "controlled" marking, factory applied.
  8. GFI Module (blank face), no indicator light, 20A - No. GFBF20 or equal.
  9. All receptacles located in exterior or wet locations shall be corrosion resistant with UV stabilized body.
- F. Plates: Leviton, or equal, except as noted:
1. The color of all faceplates shall match the color of the devices installed under/in the faceplate, except as specifically noted otherwise.
  2. For flush outlet boxes, for switches, and receptacles: nylon, color to be selected by architect, unless otherwise noted.
  3. Plates for surface-mounted outlets: galvanized steel unless otherwise noted.
  4. Weatherproof duplex receptacle plates for exterior locations with ground fault interrupter receptacles in type FS or FD boxes - Hubbell #WPFS26 or compatible equal. Verify cover compatibility with box type and device installed.
  5. Weatherproof "in-use" cover, vertical or horizontal mount, for exterior with GFCI receptacles. Die-cast metal alloy, TayMac MX series or equal with openings to match installed devices.
  6. Locking plates for duplex receptacles where noted; Pass & Seymour #WP26-L (non-weather proof).
  7. Locking plates for duplex exterior GFCI receptacles (or in wet or damp locations); Heavy duty cast aluminum flush cover with locking latch and key, Pass & Seymour #4600 with appropriate mounting plate for type of device installed. Coordinate backbox requirements and finished wall trim-out with wall installer prior to rough-in to insure an adequate and neat trim appearance upon completion.
  8. Plates for flush tele/data boxes: white nylon or as otherwise directed - provide and install at each tele/data outlet plate to match duplex power outlet plate, for jack installation under Section 27 00 00. Where the power and tele/data outlet boxes are shared the plate shall be continuous in multi-gang locations. See drawings.
- G. Equipment Disconnects: All disconnects shall be located to allow proper code required clearance in each area. Locations shown on drawings are diagrammatic only. The contractor shall coordinate exact locations in the field (with other trades) prior to rough-in to insure proper clearances.
1. Motor Disconnect Switches and Safety Switches: General Electric Company Heavy Duty Type "THD", cover interlocked with operating handle so that cover cannot be opened with switch in closed position and switch cannot be closed with cover in open position. 240V or 480V rating, single or multi-pole as required or as noted on drawings, in Nema 1 enclosure indoors or Nema 3R enclosure outdoors unless otherwise noted. Provide dual element motor circuit fuses sized as recommended by equipment manufacturer (for final equipment actually installed).
  2. Code required disconnects: Provide a local disconnect in addition to the branch circuit protection device for all equipment as required by code (whether shown or not). Disconnects shall consist of a motor rated switch (or disconnect) for all motor loads less than 3/4HP or other suitable disconnect sized to match branch circuit conductors and load current of equipment, with number of poles as required.

- H. Lugs and Connectors: Thomas and Betts "lock-tite", for No. 4 and larger wire; 3M "Scotchlock" fixed spring screw-on type wire connectors with insulator for No. 6 and smaller wire.
  - 1. All splices shall be made up with screw-on type connectors - no plug-in or push-in style connectors acceptable. Wires shall be solidly twisted together with electricians pliers before screw-on connector is installed to ensure a proper connection in the event of wire nut failure. No exceptions.
  - 2. Connectors listed or labeled for "no wire twisting required" are not an acceptable substitute for actual wire twisting.
  - 3. Utilize porcelain type connectors in all high temperature environments (above 105 degrees Celsius).
- I. Splice Insulation: "Scotch" electrical tape with vinyl plastic backing or rubber tape with protective friction tape for interior work.
  - 1. Splices in electrical cables of 600 volt insulation class in underground system duct shall be made only in accessible locations such as pullboxes, light pole handholes, etc., using a compression connector on the conductor and by insulating and waterproofing (for exterior and underground locations) by one of the following methods:
    - a. Cast type splice insulation shall be provided by means of a molded casting process employing a thermosetting epoxy resin insulating material which shall be applied by a gravity poured method or by a pressure injected method. The component materials of the resin insulation shall be in a packaged form ready for convenient mixing after removing from the package. Do not allow the cables to be removed until after the splicing material has completely set.
    - b. Gravity poured method shall employ materials and equipment contained in an approved commercial splicing kit which includes a mold suitable for the cables to be applied. When the mold is in place around the joined conductors, the resin mix shall be prepared and poured into the mold. Do not allow cables to be moved until after the splicing materials have completely set.
- J. Identification: Refer to Section 26 05 00.
- K. Firestopping: as manufactured by 3M Fire Protection Products or equal.
  - 1. Fire-rated and smoke barrier construction: Maintain barrier and structural floor fire and smoke resistance ratings including resistance to cold smoke at all penetrations, connections with other surfaces or types of construction, at separations required to permit building movement and sound vibration absorption, and at other construction gaps.
  - 2. Systems or devices listed in the UL Fire Resistance Directory under categories XHCR and XHEZ may be used, providing that it conforms to the construction type, penetration type, annular space requirements and fire rating involved in each separate instance, and that the system be symmetrical for wall penetrations. Systems or devices must be asbestos free.

### **PART 3 - EXECUTION**

#### **3.01 REFER TO BASIC ELECTRICAL REQUIREMENTS - SECTION 26 05 00 FOR WORK UNDER THIS SECTION.**

#### **3.02 TESTS**

- A. Testing and Inspection: See Section 26 08 00 - Testing.

**END OF SECTION**

## SECTION 26 5101

### LIGHTING

#### PART 1 - GENERAL

##### 1.01 WORK INCLUDED

- A. Luminaires (i.e., lighting fixtures): Refer to the Luminaire Schedule and provide a complete and working facility Lighting System. Catalog numbers in the Luminaire Schedule are design series references and may not represent the exact catalog number as specified or as required for particular installations. Provide complete luminaires to correspond with the number of LEDs, power supply, wattage, mounting hardware, ceiling type, trim, size, and special requirements as specified in the Luminaire Schedule for each luminaire type. Additional features, accessories, and options specified, described, scheduled, or necessary for installation shall be included.
- B. LEDs and power supplies.
- C. Lighting controls, including occupancy sensors. See Section 26 57 00 for Low Voltage Lighting Control System.
- D. Exit and Emergency Egress lighting where indicated and where required.
- E. Supports for outlet boxes and luminaires, including seismic restraint slack wires for recessed luminaires in suspended ceilings per code and backing in walls as required to keep luminaires secure and level.

##### 1.02 INCORPORATED DOCUMENTS

- A. Drawings and general provisions of the Contract, including General and Supplementary Conditions and other Division 1 Specification Sections, apply to this section.
- B. Section 26 05 00 and 26 27 00 apply to all work in this section.
- C. Division 03: Concrete (Bases for pole-mounted luminaires as noted in Luminaire Schedule).
- D. Division 09: Painting and Finishes (cutting of holes in finished surfaces for recessed luminaires).

##### 1.03 RELATED WORK

- A. Ceiling Access panels where required for access to equipment, outlets, transformers, etc., located above suspended ceilings, sheet rock or plaster ceilings. Coordinate with the Architect and other trades.

##### 1.04 SUBMITTALS

- A. Submit under provisions of Division 1 and Section 26 05 00.
- B. Submit (6) six sets of submittals for review by the project team unless otherwise noted in these specifications. The submittals shall include the following information:
  - 1. Product Index: The following information shall be included in the product index.
    - a. Luminaire Type. The index shall list, in alphabetical order, each luminaire type per the Luminaire Schedule.
    - b. Manufacturer's Catalog Number. Outstanding information required to make a complete catalog number shall be clearly identified in the index.
    - c. Where a pole is included with the luminaire, include the catalog number of the pole in addition to that of the luminaire.
    - d. LED Data. Provide the Manufacturer's name for each LED array including wattage, color temperature, lumen output, and color rendering index.
  - 2. Manufacturer's literature for every luminaire listed on the Luminaire Schedule.
    - a. Catalog Information:
      - 1) Luminaire Data Sheet: The manufacturer's cut sheet shall include the following:
        - (a) Photometrics: Candlepower distribution curve or table with horizontal readings at 0, 22.5, 45, and 90 degrees and vertical readings from 0 to 180

- degrees in 5 degree increments in accordance with the Illuminating Engineering Society published test procedures.
  - (b) Catalog Number Nomenclature
  - (c) Coefficient of Utilization Tables
  - (d) Luminaire Line Drawing
  - (e) Power supply (each type)
3. Data sheets for electronic ballasts and power supplies. Indicate luminaire types on applicable ballast/power supply data sheets.
  4. Data sheets for wallbox controls and other products specified in this section.
  5. Shop Drawings:
    - a. Provide shop drawings of suspension details for luminaires recessed in, mounted on, or suspended from hung ceilings. Details shall clearly illustrate proposed methods for supporting luminaires independent of the suspended ceiling system.
    - b. Detailed shop drawings of all cove or box mounted luminaires containing the following information:
      - 1) Exact field measured length (clear inside dimension) of cove pocket or box.
      - 2) Exact luminaire length and arrangement of luminaires in cove or box.
    - c. Detailed shop drawings of pendant mounted luminaires constructed with linear metal housings containing the following information.
      - 1) Support mechanism, including swivel canopies.
      - 2) Trim details.
      - 3) Closure piece details.
      - 4) Pattern configurations.
    - d. Provide shop drawings for the following luminaire types:
      - 1) Indicate specific luminaire types that require shop drawings.
  6. Samples:
    - a. Provide samples of luminaire trim where "Finish as selected by Architect" is indicated on the Luminaire Schedule. Submit two finish samples, 75 mm x 75 mm (3" x 3") minimum, of all custom color, decorative metal, or anodized aluminum finishes. Samples must be approved in writing by the Architect prior to ordering.
    - b. Submit sample of custom luminaires: complete and operational, equipped with 120V, 6 foot cord and 3 prong grounded plug. Luminaire shall be fabricated and finished as specified, full size, using specified materials & equipment. Submit one luminaire to Owner's representative for review prior to production.
    - c. Indicate specific luminaire types that require shop drawings.
- C. For Any Luminaires Substituted For Those Specified:
1. Refer to Division 1 - Product Requirements, for all substitution procedures.
  2. Provide Independent Testing Laboratories, Inc., or equal, photometric test report for each Luminaire type and lamp combination listed on the Luminaire Schedule. Test reports shall be based on Illuminating Engineering Society published test procedures and shall contain polar coordinate candlepower distribution curves in five lateral planes for luminaires with asymmetric distributions and luminaire luminance data for vertical angles above 45 degrees from nadir. Test results shall indicate luminaire efficiency for the lamp and aperture assembly specified. luminaires with efficiencies more than 2% below the values of specified luminaires are not acceptable and will be rejected.
  3. Provide photometric calculations for each room or area where a substituted luminaire is proposed. Such calculations shall be made using comprehensive lighting software, such as AGI32, and include point-by-point illuminance values at IES recommended heights, average illuminance, and maximum-to-minimum and average-to-minimum uniformity ratios. Room dimensions, configurations (including sloping ceilings), room surface

reflectances, light loss factors, and heights of suspended luminaires shall match the heights specified in the contract documents.

4. Due to the variety of lumen outputs and light distributions of LED Luminaires, substitutions will require additional review on the part of the Engineer or Architect to ascertain the equivalency of the substituted luminaires. Substitutions will be reviewed to determine their aesthetic, construction, and photometric equivalency to maintain similar design impact and performance in their intended environment. The Engineer and Architect have not included such unknown and unquantifiable review time in their scope of work and are not compensated by the Owner for such services. The Contractor shall reimburse the Engineer and Architect for labor costs to review substitutions.
5. Prior approval does not guarantee final approval by the Engineer. The Contractor shall be responsible for providing luminaires that meet or exceed the quality and performance of the specified products in their entirety. All deviations in quality and performance from the specified products must be listed and individually signed off by the engineer.
6. The Owner reserves the right to reject a proposed substitution based on their agent's professional judgment as to the utility, quality, performance, visual appropriateness, or finish of substitutions.

#### **1.05 OCCUPANCY SENSORS**

##### **A. Equipment Qualification**

1. Wall switch products must be capable of withstanding the effects of inrush current. Submittals shall clearly indicate the method used.
2. Contractor's work to include all labor, materials, tools, appliances, control hardware, sensor, wire, junction boxes and equipment necessary for and incidental to the delivery, installation and furnishing of a completely operational occupancy sensor lighting control system, as described herein.
3. Contractor and Contractor's Supplier shall examine all general specification provisions and drawings for related electrical work required as work under Division 26.
4. Contractor shall coordinate all work described in this section with all other applicable plans and specifications, including but not limited to wiring, conduit, luminaires, HVAC systems and building management systems.

#### **1.06 DELIVERY, STORAGE, AND HANDLING**

- ##### **A. Deliver products to site and store in unopened cartons in protected location. Inspect products immediately and report all damage accordingly.**

#### **1.07 GUARANTEE AND WARRANTIES**

- ##### **A. All work performed under this section must be guaranteed to be free of defects in products or workmanship for one year after date of acceptance by Owner, unless noted otherwise in General Conditions.**
- ##### **B. Warranties:**
1. Electronic power supplies must be warranted against failure for at least five years after date of substantial completion.

### **PART 2 - PRODUCTS**

#### **2.01 GENERAL**

- ##### **A. Provide luminaires as indicated in Luminaire Schedule; if conflict exists between Luminaire Schedule and Specifications, the more stringent requirement shall take precedence.**
- ##### **B. Provide luminaires new and complete with mounting accessories, junction boxes, trims, and lamps.**

- C. Provide products with UL labels appropriate to intended installation conditions, or with labels from other testing laboratories whose results are acceptable to local inspector, showing compliance with UL standards. Labels must be concealed from normal viewing angles.
- D. All products of same type by same manufacturer.

## 2.02 SOLID STATE LUMINAIRES

- A. Housing, where applicable:
  - 1. Steel bonderized or equal rust protected, or aluminum, rigid construction. Minimum gauge thickness shall be as follows:
    - a. Interior locations: No. 20-gauge steel, No. 16-gauge aluminum.
- B. Finish:
  - 1. Baked enamel finish (except when otherwise specified).
    - a. Concealed interior surfaces (this applies to interior hardware, circuit boards, etc.) matte black.
    - b. Concealed exterior surfaces: matte black.
    - c. Visible surfaces: color and texture as specified below for each luminaire type or as selected.
- C. Light Emitting Diode (LED) requirements:
  - 1. Correlated color temperature (CCT) for phosphor-coated white LEDs must have one of the following designated CCTs, as specified on the Luminaire Schedule, and fall within the following binning standards.
    - a. 3000K defined as 3045 +/- 175K
    - b. 3500K defined as 3465 +/- 245K
    - c. 4000K defined as 3985 +/- 275K
  - 2. Color spatial uniformity shall be limited to variations in chromaticity for different directions (i.e. changes in viewing angle) within 0.004 from the weighted average point on the CIE 1976 (u',v') diagram.
  - 3. Color maintenance shall be limited to a maximum change in chromaticity of 0.007 on the CIE 1976 (u',v') diagram over the lifetime of the product.
    - a. Color rendering index: Color rendering index to be determined using ANSI C78.377-2008 and applicable IESNA standards.
    - b. Laboratory tests must be produced using specific module(s)/array(s) and power supply combination that will be used in production.
    - c. Manufacturers must provide a test report from a laboratory accredited by NVLAP or one of its MRA signatories
  - 4. Lumen depreciation
    - a. Lumen depreciation to be measured using IESNA LM-80-08 and TM-21-11 standard for IES approved method of measuring lumen maintenance of LED light sources.
    - b. Phosphor-coated white LED modules/arrays shall deliver at least 70% of initial lumens for a minimum of 50,000 hours when installed in-situ and operated at 100% output and the maximum specified operating temperature.
    - c. Colored LED modules/arrays shall deliver at least 50% of initial lumens for a minimum of 50,000 hours when installed in-situ and operated at 100% output and the maximum specified operating temperature.
  - 5. Acceptable LED manufacturers:
    - a. Cree
    - b. Nichia
    - c. Osram Opto Semiconductors
    - d. Philips Lumileds
    - e. Sora

f. Xicato

D. Luminaire Efficacy:

1. Luminaire efficiency shall be measured using IESNA LM-79-08 standard for electrical and photometric measurements of solid state lighting products.
2. Manufacturer shall provide published luminaire efficacy, which is defined as luminaire light output divided by luminaire input power measured in a 25 degree Celsius environment. Efficacy shall include power supply, thermal, optical, and luminaire losses.

E. Thermal Management:

1. Solid state luminaire shall not exceed LED manufacturer's maximum junction temperature requirements when operated in-situ at luminaire manufacturer's maximum ambient operating temperature and 100% light output.
2. Solid state luminaires shall be thermally protected using one or more of the following thermal management techniques:
  - a. Metal core board
  - b. Gap pad
  - c. Internal monitoring firmware
3. Solid state luminaire housing shall be designed to transfer heat from the LED board to the outside environment.

F. Power Supplies (LED Drivers) requirements:

1. Power factor of 0.90 or greater for primary application
2. Input current shall have Total Harmonic Distortion (THD) of less than 20%.
3. Minimum operating temperature of minus 20 degrees Celsius or below when used in luminaires intended for outdoor applications.
4. Operating frequency equal to or greater than 120 Hz.
5. Operate with sustained input variations of +/- 10% (voltage and frequency) with no damage to the driver.
6. Tolerate sustained open circuit and short circuit output conditions without damage and without need for external fuses or trip devices.
7. Output shall be regulated to +/- 5% across published load range.
8. Class A sound rating.
9. Outputs shall have current limiting protection.
10. Operate LEDs at constant and regulated current levels. LEDs shall not be overdriven beyond the diode manufacturer's specified nominal voltage and current.
11. Inrush currents not exceeding peak currents specified in NEMA 410.

G. Solid State Lighting Controls:

1. Control interface to dimmable power supplies shall consist of one of the following:
  - a. Line Voltage Dimming. Controls to be rated for magnetic or electronic low voltage transformer operation.
  - b. Low voltage (0-10V) control. Controls to be compatible with either current sink or current source operation.
  - c. DMX control
2. Dimmable LED power supplies shall use pulse width modulation (PWM) or constant current reduction (CCR) to regulate power to LEDs.
  - a. PWM power supplies shall have 12-bit or greater resolution to obtain flicker-free operation throughout their dimming range.
  - b. PWM power supplies shall be provided in luminaires that will be dimmed lower than 40% and must maintain consistent color temperature.
  - c. CCR power supplies shall be provided in areas that have strict electromagnetic interference (EMI) requirements, high motion activity, or rotating machinery.

H. System Installation

1. Hardwired connections to solid state luminaires shall be reverse polarity protected and provide high voltage protection in the event connections are reversed or shorted during the installation process.
2. All solid state luminaires (100% of each lot) shall undergo a minimum eight-hour burn-in test during manufacturing. Solid state lighting installations shall be UL Listed as a low-voltage lighting system including, but not limited to, luminaire, power supply, controller, keypad, and wiring.

I. Warranty

1. Luminaires, drivers, and controllers for solid state lighting systems shall be covered by a five-year warranty against defects in workmanship or material. Warranty shall include in-warranty service program providing for payment of authorized labor charges incurred in replacement of inoperative in-warranty equipment.

**2.03 LUMINAIRE CONSTRUCTION**

- A. Sheet metal: materials and thicknesses shall be 20 gauge (0.7 mm or 0.027") min., free of dents, scratches, oil-can, or other defects.
- B. Painted luminaires: exposed weld marks, joints, and seams shall be filled and sanded smooth before finishing.
- C. All edges cleaned and dressed to remove sharp edges or burrs.
- D. Extrusions: 1/10" min. wall thickness, smooth and free of tooling lines, with cast end plates that exactly match extrusion profiles.
- E. Castings: smooth, free of pits, scales, gate marks, or blemishes.
- F. Spinnings shall have 1/32" min. thickness, smooth, free of spinning lines or blow-back, with clean edges.
- G. Welds: Follow recommendations of American Welding Society. All welds continuous and free of spatter, residue, or warping.
- H. No light leaks visible in finished room. Ensure that downlight housings mounted in wood slat ceilings are not visible from below. Field paint exterior of housing with high temperature paint if necessary.
- I. Exposed end plates and joiners, with concealed fasteners.
- J. End-to-end mounted luminaires: Verify row configurations and provide joiners, aligning splines, and trims to suit.
- K. Hardware:
  1. Steel or aluminum interior luminaires: cadmium-plated hardware.
  2. Steel or aluminum exterior luminaires: stainless steel hardware.
  3. Stainless steel luminaires: stainless steel hardware.
  4. Copper alloy luminaires: brass hardware.
- L. Raceways: Where used for through wiring, luminaires must be approved for use as raceways.

**2.04 RECESSED LUMINAIRES**

- A. Point-source luminaires: provide pre-wired junction box and thermal protection, and provide slack wires to structure at two diagonal corners.
- B. Troffer luminaires: provide hold-down clip at each luminaire corner, and slack wires to structure as detailed on the drawings. The detail will take precedence.
- C. Verify ceiling construction details and provide luminaire housings and trims to suit.



- D. Non-accessible ceilings: Provide access to junction boxes, ballasts, transformers, and battery packs through luminaire apertures; no access panels in ceiling.
- E. Mounting frames: To prevent rusting, provide galvanized steel or cast aluminum frames for installation in damp locations or in plaster ceilings.
- F. Adjustable luminaires shall be provided with rotation and tilt locking devices.

## 2.05 PENDANTS

- A. Stem-mounted: 16 mm (5/8") max. o.d. stem with ball swivels at top (and bottom of linear luminaires) to permit 45 degree swing in any direction from vertical. Flat canopy to permit splice inspection after installation. Pendants must permit +/- 13 mm (1/2") threaded vertical adjustment after installation, leaving at least 6 mm (1/4") thread contact at all points.
- B. Provide internal safety cable from luminaire body to stud in outlet box.
- C. Cable-mounted: 1 X 7 strand 3/32" diameter stainless steel aircraft cable, factory crimped, independently tested and verified to exceed 1500 pounds.
  - 1. Verify mounting heights for each luminaire and provide cable lengths and coordinate cord lengths with manufacturer as required prior to ordering luminaires. Provide aircraft cable adjuster nipple with locking jaws.
- D. Supports: Carry luminaire weight to structure and provide horizontal bracing from suspension points to ceiling framing to prevent sideways shifting. Provide diagonal seismic restraint wires per code.

## 2.06 TRIMS

- A. Trims must fit tightly and be held in by gravity, spring clips, or mechanical fasteners. Trims must not drop out under normal conditions or seismic forces which do not exceed the design criteria of the building.
- B. Aluminum parabolic cones shall be smooth, properly shaped, with Alzak finish in colors as indicated.
  - 1. No hot spots or lamp images visible at angles shallower than lamp shielding angle.
  - 2. Self-flange cones must bend parallel to ceiling and cover ceiling hole without additional trim ring. Unpainted flange, shall have the same finish as cone interior.
  - 3. Cones and louvers for fluorescent luminaires must have permanent anti-iridescence treatment.
- C. Lenses, diffusers, and patterned glass: glass or virgin acrylic as noted, with patterns as noted.
  - 1. Finished thickness 2 mm (1/10") min. unless noted otherwise.
  - 2. Linear runs over 1200 mm (4'-0") long shall be in equal-length pieces.

## 2.07 FINISHES

- A. Steel Reflectors: Unless otherwise specified, the reflector surface finish shall be of synthetic white enamel or polyester powder coating. Finish shall show no indication of chipping, cracking, flaking or any other sign of loss of adhesion. The initial reflection factor shall be not less than 88 percent averaging 5 randomly selected points on the reflector. After 100 hours of exposure to the radiation of a glass enclosed carbon arc lamp, such as a Fade-O-Meters, the reflectance of the exposed portion shall not be less than 5 percent and finish shall show no appreciable color change. The carbon arc lamp shall be operated at appreciable color change. The carbon arc lamp shall be operated at 13 plus or minus 0.5 amperes at 140 volts. The reflector shall be placed ten inches from the arc and the lamp so ventilated that the temperature of the exposed portion does not exceed 105 degrees F.
- B. Aluminum Reflectors: Reflecting surfaces shall be provided with either a specular or diffuse finish as indicated. Reflection factors shall be not less than 83 percent for specular reflecting surfaces. Each reflecting surface shall be protected by dense coating of oxide weighing not less

than 5.0 milligrams per square inch, applied by an anodic process. The reflector shall be given a sealing treatment that will prevent staining of the reflecting surface when subjected to a stain test. All aluminum reflectors & louvers shall be a low iridescent equivalent to that provided by Coil Anodizers.

- C. Non-Reflecting Surfaces: Unless otherwise specified, the finish on all non-reflecting exterior surfaces shall be aluminum oxide or aluminum; white, gray or aluminum paint on steel; nickel or chromium plating on copper alloy. Fastening devices shall be nickel, chromium, cadmium or zinc plated. All painted surfaces shall be free of tears, star marks, blisters, pinholes, chipping and any other defects that may impair appearance or serviceability.

## 2.08 LAMPS

- A. Relamp luminaires or replace LED boards and power supplies at no cost to owner if lamps or LEDs exhibit color variation, flicker, or burn out within 90 days of substantial completion date.
- B. LEDs:
  - 1. LED quantity, wattage, and color temperature as specified for each LED luminaire.
  - 2. 3500 deg. K color temperature for interior luminaires, 3000 deg. K for exterior luminaires, unless otherwise specified.

## 2.09 DRIVERS AND TRANSFORMERS

- A. General:
  - 1. Verify input voltages and match to branch circuit voltages.
  - 2. Remote drivers or transformers: Provide suitable enclosures and mounting hardware, and install in accessible, ventilated locations.
    - a. Secondary wiring: provide number and size of conductors as required, with 3% max. voltage drop between transformer and last lamp.
    - b. Keep transformers at least 300 mm (12") apart and do not stack vertically.
- B. LED Drivers:
  - 1. High power factor, thermally-protected.
  - 2. Compatible with LED lamps being used.
  - 3. Capable of dimming LED source without perceptible flicker or stroboscopic effects.

## 2.10 EMERGENCY LIGHTING AND EXIT SIGNS

- A. Emergency lighting:
  - 1. Provide lighting for paths of egress as required by Code.
- B. Emergency lighting to consist of wall or ceiling mounted (normally off) lamp head units with battery back-up for 90 minutes of egress lighting output.
- C. Description of Systems:
  - 1. Auxiliary battery packs mounted integral to luminaires shall provide no less than 1400 lumen output for a minimum of 90 minutes.
  - 2. Surface mounted luminaire with two (2) reflector-type LED lamps on emergency battery with 90 minute operation.
- D. Auxiliary Battery Pack/Ballasts for LED Luminaires:
  - 1. Pure lead or nickel-cadmium, sealed and maintenance-free.
  - 2. Automatic transfer to battery power if supply voltage drops below 75% of normal.
  - 3. Must provide at least 87-1/2% or rated battery voltage for 90 minutes minimum.
  - 4. Internal circuitry to provide continuous "trickle" charge and to prevent deep discharge below 80% of rated battery voltage.
  - 5. Full recharge within 24 hours after restoration of normal power.
  - 6. Charge indicator light visible and test switch operable without tools.
  - 7. Concealed inside luminaire or above ceiling, but replaceable through luminaire aperture.

8. Designed to run one or two lamps per luminaire with minimum of 1400 lumen output.
  9. Acceptable manufacturers: Bodine, Dual-Lite, Emergi-Lite, Lithonia, Radiant, Siltron.
- E. Recessed emergency luminaire:
1. Cold rolled steel housing.
  2. 12v sealed permanent magnet type motor with 30 yr. Service life.
  3. Solid state electronics.
  4. Integral test switch and pilot light to indicate charge rate.
  5. Acceptable manufacturers: Concealite.
- F. Exit signs shall be edge or back lit LED, surface-mounted on ceiling or wall, with integral battery packs as described above.
1. Fabricated aluminum construction, no light leaks around canopy. Plain box, with no decorative trim.
  2. Letters shall be 20mm (3/4") stroke, 150 mm (6") high, with concealed knockouts for left or right arrows, brightness and evenness of illumination per code, green color.
    - a. Battery pack contained in basic luminaire housing. No add-on packs or canopies.
    - b. Green LED lamps located at interior perimeter for indirect illumination of stencil letters.
    - c. Provide finish as specified in the Luminaire Schedule.
    - d. Knock out the arrows as indicated on the plans.
- G. Emergency luminaires supplied by a separate emergency power source.
1. For luminaires supplied by a separate emergency power source, provide "switched" control of the emergency designated lamps to allow complete "off" control when required by the user. The switched control shall include an automatic transfer feature to automatically turn "on" the emergency designated lamps upon the normal source power failure.
  2. Automatic transfer function shall be provided using a UL 924 listed relay, LVS Inc. #EPC-A or equal, suitable for mounting in a standard 4" square j-box (min. 2.5" deep). Transfer relay shall provide automatic diagnostic test feature which shall maintain power to the emergency designated lamps for 15 seconds after the room is switched off via the respective light switch or control relay. Emergency designated lamps shall turn off after the 15 second test period and shall come back on when the control device is turned back on to restore full lighting to the space.
  3. Provide (1) transfer module per "switched" zone.
- H. Emergency luminaires supplied by a dimmer panel and/or emergency source.
1. For luminaires supplied by a dimmed power source, provide "dimmed" control of the emergency designated lamps to allow normal dimming control with the normal lamps. The dimmed control shall include an automatic transfer feature to automatically turn "on" the dimmed lamps to full light output upon the normal source power failure.
  2. Automatic transfer function shall be provided using a UL 924 listed relay, LVS Inc. #EPC-D (2-wire dimmed), #EPC-D-U (3-wired dimmed) or equal, suitable for mounting in a standard 4" square j-box (min. 2.5" deep).
  3. Provide (1) transfer module per "dimmed" zone.
  4. For DMX-controlled LED emergency lighting, provide control bypass, ETC DEBC series with emergency bypass detection kit - quantity of DEBC outputs as indicated on drawings.

## 2.11 WALL-BOX DIMMERS

- A. Provide dimmer controls as specified on the drawings and in Specifications Section 26 57 00.
- B. Ganging and Labeling:
1. Dimmers and matching switches in same location shall be installed in same gang box.

2. Follow dimmer manufacturer's instructions for gang-box sizes. Do not break off fins on dimmers unless noted otherwise.
  - a. 1+1, 4+1, 7+1 installation: to gang an even number of small devices without breaking off fins, provide multi-gang box as indicated (1, 4, or 7 gangs) and provide additional single-gang box at end, with ears of single box 70 mm (2-3/4") o.c. from last set of ears on multi-gang box.
  - b. When rows of devices are stacked vertically space rows 230 mm (9") o.c. to allow heat dissipation.
3. Provide Lutron multi-gang plates to cover each group of devices.
4. Plates with "-NFB" in catalog number with no fins broken.
5. Plates with "-FB" in catalog number: break off all interior fins on devices, but do not break off outside fins at either end of row.
6. Nova-T: install aligning backplate (provided by Lutron with each multi-gang plate) between wall and devices.
7. Labels: text as indicated 3 mm (1/8") high, all capital letters, engraved on device faceplate, filled with black paint and wiped clean.

## 2.12 OCCUPANCY SENSORS

### A. General

1. Wall switch sensors shall be capable of detection of occupancy at desktop level up to 300 square feet, and gross motion up to 1000 square feet.
2. Wall switch sensors shall accommodate loads from 0 to 800 watts at 120 volts; 0 to 1200 watts at 277 volts and shall have 180° coverage capability.
3. Wall switch products shall utilize Zero Crossing Circuitry which increases relay life, protects from the effects of inrush current, and increases sensor's longevity.
4. Wall switch sensors shall have no leakage current to load, in manual or in Auto/Off mode for safety purposes and shall have voltage drop protection.
5. Where specified, wall switch sensors shall provide a field selectable option to convert sensor operation from automatic-ON to manual-ON.
6. Where specified, vandal resistant wall switch sensors shall utilize a hard lens with a minimum 1.0mm thickness. Products utilizing a soft lens will not be considered.
7. Passive infrared sensors shall utilize Pulse Count Processing and Digital Signature Analysis to respond only to those signals caused by human motion.
8. Passive infrared sensors shall utilize mixed signal ASIC which provides high immunity to false triggering from RFI (hand-held radios) and EMI (electrical noise on the line), superior performance, and greater reliability.
9. Passive infrared sensors shall have a multiple segmented Lodif Fresnel lens, in a multiple-tier configuration, with grooves-in to eliminate dust and residue build-up.
10. Where specified, passive infrared and dual technology sensors shall offer daylighting foot-candle adjustment control and be able to accommodate dual level lighting.
11. Dual technology sensors shall be corner mounted to avoid detection outside the controlled area when doors are left open.
12. Dual technology sensors shall consist of passive infrared and ultrasonic technologies for occupancy detection. Products that react to noise or ambient sound shall not be considered.
13. Ultrasonic sensors shall utilize Advanced Signal Processing to adjust the detection threshold dynamically to compensate for constantly changing levels of activity and air flow throughout controlled space.
14. Ultrasonic operating frequency shall be crystal controlled at 25 kHz within  $\pm 0.005\%$  tolerance, 32 kHz within  $\pm 0.002\%$  tolerance, or 40 kHz  $\pm 0.002\%$  tolerance to assure reliable performance and eliminate sensor cross-talk. Sensors using multiple frequencies are not acceptable.

15. All sensors shall be capable of operating normally with electronic ballasts, PL lamp systems and rated motor loads.
  16. Coverage of sensors shall remain constant after sensitivity control has been set. No automatic reduction shall occur in coverage due to the cycling of air conditioner or heating fans.
  17. All sensors shall have readily accessible, user adjustable settings for time delay and sensitivity. Settings shall be located on the sensor (not the control unit) and shall be recessed to limit tampering.
  18. In the event of failure, a bypass manual override shall be provided on each sensor. When bypass is utilized, lighting shall remain on constantly or control shall divert to a wall switch until sensor is replaced. This control shall be recessed to prevent tampering.
  19. All sensors shall provide an LED as a visual means of indication at all times to verify that motion is being detected during both testing and normal operation.
  20. Where specified, sensor shall have an internal additional isolated relay with Normally Open, Normally Closed and Common outputs for use with HVAC control, Data Logging and other control options. Sensors utilizing separate components or specially modified units to achieve this function are not acceptable.
  21. All sensors shall have UL rated, 94V-0 plastic enclosures.
- B. Circuit Control Hardware - CU
1. Control Units - For ease of mounting, installation and future service, control unit(s) shall be able to externally mount through a 1/2" knock-out on a standard electrical enclosure and be an integrated, self-contained unit consisting internally of an isolated load switching control relay and a transformer to provide low-voltage power. Control unit shall provide power to a minimum of two (2) sensors.
  2. Relay Contacts shall have ratings of:
    - a. 13A - 120 VAC Tungsten
    - b. 20A - 120 VAC Ballast
    - c. 20A - 277 VAC Ballast
  3. Control wiring between sensors and controls units shall be Class II, 18-24 AWG, stranded U.L. Classified, PVC insulated or TEFLON jacketed cable suitable for use in plenums, where applicable.
  4. Minimum acceptable wire gauge from the circuit control hardware relays shall be #14 AWG.
- C. Acceptable Manufacturers
1. The Watt Stopper, or Pre-Approved Equal: For pre-approval, provide all the information listed under "submittals" a minimum of ten (10) working days prior to initial bid date.
  2. The listing of any manufacturer as "acceptable" does not imply automatic approval. It is the sole responsibility of the Contractor to ensure that any price quotations received and submittals made are for sensors that meet or exceed the specifications and the requirements of the contract documents.
  3. Products
    - a. All products shall be Watt Stopper product numbers:
      - 1) Ceiling sensors: WT-605, WT-600, WT-1105, WT-1100, WT-2205, WT-2200, WT-2250, WT-2255, W-500A, W-1000A, W-2000A, W-2000H, WPIR, DT-200, DT-205, CX-100, CX-105, CI-200, CI-205
      - 2) Wall sensors: WI-200, WS-120/277, WA-100, WD-170, WD-180, WD-270, WD-280
      - 3) Power and Slave Packs: B120E-P, B277E-P, C120E-P, C277E-P, S120/277-P, AT-120, AT-277

## **PART 3 - EXECUTION**

### **3.01 PREPARATION**

- A. Architectural Reflected Ceiling Plans and Elevations shall govern exact location and mounting conditions for all luminaires. Contractor shall coordinate luminaire mounting and compatibility with ceiling construction and other trades.
- B. Coordinate work with other trades. Location of lighting has priority over location of new framing (except major structural members), ducts, diffusers, sprinklers, speakers, smoke detectors, and other obstructions.
- C. If obstructions are encountered which prevent installation of luminaires according to drawings, notify Architect immediately and do not proceed until conflict has been resolved.
- D. Coordinate the location of luminaires in mechanical or unfinished spaces. Locations shown on Drawings may be adjusted by the Contractor to suit conditions. Install luminaires to avoid obstructions and maximize light output, 2100 mm (7'-0") min. mounting height.
- E. In Elevator Machine Rooms, locate the luminaires so that the illumination level at the floor is not less than 200 lx (19 fc). Illuminate areas in front of and behind (if accessible) controllers, machines and other elevator equipment.
- F. In Elevator Pits, locate the luminaires so that the illumination level at the pit floor is not less than 100 lx (10 fc).
- G. Coordinate the location of any exposed conduit used to feed luminaires with the Architect prior to installation.

### **3.02 INSTALLATION**

- A. General:
  - 1. Contractor shall be responsible for handling and installation of luminaires including all supports, hangers and hardware necessary for a complete installation. Luminaires shall be clean, plumb, level in straight lines, without distortion. Luminaires must be installed so they do not shift during relamping or adjustment. Remedy any light leaks which may develop after installation of recessed or enclosed luminaires.
  - 2. Install luminaires at locations and heights as indicated, in accordance with luminaire manufacturer's written instructions, applicable requirements of NEC, NECA's "Standard of Installation", NEMA standards, and with recognized industry practices to ensure that luminaires fulfill requirements.
  - 3. Point-source luminaires shall be located as dimensioned, or in center of tile or on tile joint as drawn; 6 mm (1/4") max. off-center tolerance.
  - 4. Linear luminaires shall have 3 mm (1/8") max. horizontal or vertical alignment variation in any 5 m (16-ft.) portion of run.
  - 5. Tighten connectors and terminals, including screws and bolts, in accordance with equipment manufacturer's published torque tightening values for equipment connectors. Where manufacturer's torquing requirements are not indicated, tighten connectors and terminals to comply with tightening torques specified in UL Stds. 486 A and B, and the National Electrical Code.
  - 6. Clean luminaires of dirt and construction debris upon completion of installation. Clean fingerprints and smudges from lenses.
  - 7. Remove and replace luminaires that may have been damaged during construction at no additional cost to the Owner.
  - 8. Protect installed luminaires from damage during remainder of construction period.
  - 9. Provide equipment grounding connections for luminaires as indicated. Tighten connections to comply with tightening torques specified in UL 486 A to assure permanent and effective grounds.

10. Install luminaires, lamps, lenses, etc., after building is enclosed, weather tight and environmental conditions are nominally the same as expected for the complete spaces. All lenses, glass, reflectors, and refractors shall be clean and free of chips, cracks, and scratches.
  11. All wall mounted luminaires and all ceiling mounted surface luminaires including exit lights shall be fed through a luminaire Stud/Hickey/Nipple assembly and with provisions to prevent luminaire turning.
  12. Installation of exit signs shall be coordinated with other trades to ensure signs are visible as intended.
  13. All junction box cover plates for the lighting branch circuit system shall be clearly marked with a permanent ink felt pen identifying the branch circuit and control relay (panel number, circuit number, lighting control cabinet designation and control relay number) contained in the box.
  14. Provide permanently affixed adhesive labels with machine printed lettering (min. 1/8" high) at junction boxes serving luminaires that are supplied by (2) electrical sources (i.e. normal and emergency lighting). Label to read "CAUTION - This luminaire is powered by (2) separate sources. The normal power source breaker and the emergency power source breaker must be turned off before servicing this luminaire."
- B. Recessed Luminaires:
1. The contractor shall verify the fire rating of the ceiling system and wall in which the luminaires are to be mounted. Where luminaires are installed in fire rated ceilings or walls, provide fire rated enclosures around and over luminaires to maintain ceiling fire rating. No additional cost shall be allowed for failure to include such enclosures and installation in the bid.
  2. Holes for Recessed Point-Source Luminaires: Cut holes to follow luminaire housings exactly so no gaps will be visible after trims are installed.
  3. Install bottom of housing aligned with finished ceiling.
  4. Keep ceiling insulation at least 75 mm (3") away from luminaires. Exception: luminaires with insulated contact (IC) rating shall be permitted to be in contact with insulation.
  5. Install trims after painting of spaces. Install trims tightly, with no gaps or light leaks.
  6. Seismic restraints: Provide and install slack wires and hold-down clips per code.
  7. Wallwashers:
    - a. Orient wallwasher housings according to manufacturer's instructions to maximize brightness on the upper portion of the wall.
- C. Ceiling-Mounted and Pendant Luminaires:
1. Provide support for outlet boxes and suspension points so luminaires can be installed securely, including seismic supports per code.
    - a. Luminaire weight less than 23 kg (50 lb) at each suspension point: hang from strap or stud on outlet box, or at non-feed points, provide 1/4"-20 stud projecting 20 mm (3/4") below ceiling.
    - b. Luminaire weight 23 kg (50 lb) or more at each suspension point: hang directly from structure, either independent of outlet box or from stud extending through outlet box to structure, unless the outlet box is listed for not less than the weight to be supported. Boxes used as the sole support of luminaires weighing more than 50 pounds must be listed and marked by the manufacturer with the maximum weight.
  2. Pendants:
    - a. Provide horizontal bracing from suspension points to ceiling framing to prevent sideways shifting.
    - b. Provide diagonal seismic restraint wires above ceiling per code.
    - c. Furnish suspended luminaires with universal joint type hanger canopy (and longitudinal sway adapter at each stem connection point for linear luminaires), to

permit 45 degree swivel on 360 degree circle from Nadir at canopy (and 45 degree longitudinal movement at sway adapter).

- d. Luminaires over 450 mm (18") wide shall be provided with supports at all corners.
- e. Install pendants plumb and level.
- f. Verify luminaire weights and provide backing in ceiling as required.

D. Wall-Mounted Luminaires:

- 1. Mounting heights shown on Drawings are measured from finished floor to centerline of outlet box or recessed housing, unless otherwise noted.
- 2. Verify luminaire weights and provide backing in wall as required. Luminaires must not droop or tilt away from wall.
- 3. Wet locations: install sealant between luminaire and outlet box.
- 4. In circulation areas, wall-mounted luminaires must not project more than 100 mm (4") from wall if mounted above 685 mm (27") and below 2030 mm (80").

### 3.03 LIGHTING CONTROLS

- A. Install controls so that all operable parts are at 48 inches (1220 mm) maximum height.
- B. Lighting controls to include occupancy sensors in most spaces (for local control) and relay system lighting control for larger common spaces as indicated on the drawings.
- C. Occupancy sensors shall initially be set as follows:
  - 1. Maximum sensitivity.
  - 2. Maximum time delay (or 30 minutes).
  - 3. Manual-on operation.
  - 4. Automatic off operation.
  - 5. Aim all adjustable sensors to properly cover room areas.
- D. Timeclock System shall initially be set to control the low voltage relays as per the Relay Panel Schedule LCP.
  - 1. Assign all interior relays to an automatic off sweep, with flick warn (except those noted as "NL"). Off time shall be set to an Owner-determined time in the evening, after dark or normal business operations.
  - 2. Off signals to may originate from BAS system, which shall be inter-connected to the Lighting Control System where indicated on the drawings.
  - 3. Assign all interior relays noted as "NL" to be on 24 hours per day. No automatic relay operation.
  - 4. Assign "after hours" and "Weekend / Holiday" hours to match normal business calendar and times.
  - 5. All interior relays shall be allowed to be overridden by use of the local dataline switches for a maximum of 2 hours (per Title 24) when used after hours or on Weekends / Holidays. If used during these times, automatic shut-off shall re-activate at the end of the 2-hour period.
  - 6. All interior relays shall be allowed to be overridden by use of the local dataline switches when used during normal business hours. Standard timeclock operation shall resume with the next scheduled timeclock function for each relay.
  - 7. Assign all exterior relays for automatic on operation with the astro-dial feature, set to 30 minutes before sunset. Latitude = 37.5 degrees North / Longitude = 122 degrees West.
  - 8. Assign exterior relays noted as "astro-on, astro-off" for automatic off operation with the astro-dial feature, set to 30 minutes after sunrise. Latitude and Longitude as noted above.
  - 9. Assign exterior relays noted as "astro-on, timeclock-off" for automatic off operation with the normal timeclock feature, set to an owner determined time in the late evening.
  - 10. Assign exterior relays noted as "NL" or "On All Night" for astro-dial operation, for automatic on 30 minutes before sunset and automatic off 30 minutes after sunrise.



**3.04 DELIVERY, STORAGE, & HANDLING:**

- A. Deliver luminaires in factory-fabricated containers or wrappings, which properly protect luminaires from damage. Inspect luminaires immediately upon delivery to ensure correct shipment without damage.
- B. Store luminaires in original packaging. Store inside well-ventilated area protected from weather, moisture, soiling, extreme temperatures, humidity, laid flat and blocked off ground.
- C. Handle luminaires carefully to prevent damage, breaking, and scoring of finishes. Do not install damaged units or components; replace with new. Protection wrapping on louvered (parabolic) luminaires shall not be removed until luminaires are ready for operation.

**3.05 SEQUENCING AND SCHEDULING:**

- A. General:
  - 1. Coordinate with other work including wires/cables, electrical boxes and fittings, and raceways, to properly interface installation of luminaires with other work.
  - 2. Sequence lighting installation with other work to minimize possibility of damage and soiling during remainder of construction.

**3.06 PROJECT CLOSEOUT**

- A. Clean luminaires and remove plaster and paint spatters.
- B. Clean fingerprints and dust from downlight reflectors. Refer to manufacturer's instructions.
- C. Verify that luminaires and controls are working at time of final acceptance by Owner.
  - 1. Repair or replace lighting control devices that are inoperable.
  - 2. Repair or replace LED modules or entire LED luminaires that are inoperable.
  - 3. Repairs and/or replacements shall be at no additional cost to the Owner.
- D. Test emergency lighting system for 90 minutes in presence of Owner's representative, check each luminaire for proper operation at end of 90-minute test, then recharge for 24 hours and briefly test each luminaire again for proper operation.
- E. Install and aim adjustable lighting as directed by Architect.
  - 1. Provide personnel, lifts, ladders, and walkie-talkies as required.
  - 2. Aiming will occur at night, outside of normal working hours, at times as approved by the Architect.
- F. Prepare two copies of a Lighting Systems Maintenance Manual consisting of the following in a hardcover binder. Deliver to Architect. After review, Architect will deliver one copy to Owner.
  - 1. One complete set of approved submittals, including product data and shop drawings.
  - 2. Luminaire cleaning instructions, including chemicals to be used or avoided.
  - 3. Instructions for code-required testing and maintenance of emergency lighting system.

**END OF SECTION**

**SECTION 26 5601**  
**SITE LIGHTING**

**PART 1 - GENERAL**

**1.01 WORK INCLUDED**

- A. Luminaires
- B. LED's
- C. Power Supplies/Drivers
- D. Poles
- E. Pole bases
- F. Controls and wiring

**1.02 SYSTEM DESCRIPTION**

- A. Furnish all labor, materials, apparatus, tools, equipment transportation, temporary construction and special or occasional services as indicated on the Drawings or described in these Specifications and as required to make a complete working site lighting system.
- B. Illumination levels shall be in accordance with recommendations by the Illuminating Engineering Society (IES).

**1.03 INCORPORATED DOCUMENTS**

- A. Section 26 05 00 and Section 26 51 01 apply to all work in this Section.

**1.04 SUBMITTALS**

- A. Catalog Information:
  - 1. Luminaire (each type) with photometric pattern.
  - 2. Contactors.
  - 3. Ballast or Driver (each type)
  - 4. Poles.
  - 5. Brackets.
- B. Shop Drawings.
- C. Manufacturer's Recommendations: Provide two copies before material is used.
  - 1. PVC conduit joints and junctions.
  - 2. Solvent welding directions.
  - 3. Pole bases.
- D. Laboratory Test: Determine soil density relationships for compaction of backfill material in accordance with ASTM D1557, Method D.

**PART 2 - PRODUCTS**

**2.01 MATERIAL AND EQUIPMENT**

- A. Provide new materials and equipment unless otherwise specifically indicated or specified. Materials shall be listed by Underwriter's laboratories, Inc. (U.L.) and bear evidence of such approval where applicable.
- B. Luminaires: Site luminaires shall be weatherproof. Reflectors and refractors shall provide the light configuration indicated and conforming to IES recommendations.
- C. Luminaires and poles shall be finished in epoxy enamel designed to withstand the effects of salt spray. Lens shall be securely attached to the lens frame for security during maintenance and relamping.
- D. Lighting Contactors: NEMA ICS 2. Electrically operated, magnetically held unit in NEMA enclosure, rated poles and ratings as indicated on Drawings. Units shall have silver alloy

double breaker contacts and coil clearing contacts and shall require no arcing contacts. On-off selector switch.

- E. Poles, Brackets, Pole Bases and Attachments: Shall be rated for service with wind velocities of 100 mph considering the force exerted by the wind on the maximum exposure of the fixture luminaire selected.
- F. Poles shall be anchor base type round, height and style as indicated, finished to match luminaire, complete with handhole and gasketed cover, anchor bolts with leveling and locking screws, grounding connection, and matching base cover.
- G. Concrete pole bases shall be cast-in-place reinforced concrete as indicated with anchor bolts and conduit entries as per manufacturer. Concrete shall be rated 3,000 PSI at 28 day test.
- H. Concrete:
  - 1. Concrete for electrical requirements shall be at least 3,000 psi concrete with 1-inch maximum aggregate conforming to the requirements of Division 3 for Cast-In-Place concrete.

## 2.02 SOLID STATE LUMINAIRES

- A. Housing, where applicable:
  - 1. Steel bonderized or equal rust protected, or aluminum, rigid construction. Minimum gauge thickness shall be as follows:
    - a. Interior locations: No. 20-gauge steel, No. 16-gauge aluminum.
- B. Finish:
  - 1. Baked enamel finish (except when otherwise specified).
    - a. Concealed interior surfaces (this applies to interior hardware, circuit boards, etc.) matte black.
    - b. Concealed exterior surfaces: matte black.
    - c. Visible surfaces: color and texture as specified below for each luminaire type or as selected.
    - d. Exterior luminaire finish: refer to Luminaire Schedule.
- C. Light Emitting Diode (LED) requirements:
  - 1. Correlated color temperature (CCT) for phosphor-coated white LEDs must have one of the following designated CCT's and fall within the following binning standards.
    - a. 3000K defined as 3045 +/- 175K
  - 2. Color spatial uniformity shall be limited to variations in chromaticity for different directions (i.e. changes in viewing angle) within 0.004 from the weighted average point on the CIE 1976 (u',v') diagram.
  - 3. Color maintenance shall be limited to a maximum change in chromaticity of 0.007 on the CIE 1976 (u',v') diagram over the lifetime of the product.
    - a. Color rendering index: Color rendering index to be determined using ANSI C78.377-2008 and applicable IESNA standards.
    - b. Laboratory tests must be produced using specific module(s)/array(s) and power supply combination that will be used in production.
    - c. Manufacturers must provide a test report from a laboratory accredited by NVLAP or one of its MRA signatories
  - 4. Lumen depreciation
    - a. Lumen depreciation to be measured using IESNA LM-80-08 standard for IES approved method of measuring lumen maintenance of LED light sources.
    - b. Phosphor coated white LED module(s)/array(s) shall deliver at least 70% of initial lumens for a minimum of 50,000 hours when installed in-situ and operated at 100% output and the maximum specified operating temperature.

- c. Colored LED module(s)/array(s) shall deliver at least 50% of initial lumens for a minimum of 50,000 hours when installed in-situ and operated at 100% output and the maximum specified operating temperature.
  5. Acceptable LED manufacturers:
    - a. Cree
    - b. Nichia
    - c. Osram Opto Semiconductors
    - d. Philips Lumileds
- D. Luminaire Efficacy:
1. Luminaire efficiency shall be measured using IESNA LM-79-08 standard for electrical and photometric measurements of solid state lighting products.
  2. Manufacturer shall provide published luminaire efficacy, which is defined as luminaire light output divided by luminaire input power measured in a 25 degree Celsius environment. Efficacy shall include power supply, thermal, optical, and luminaire losses.
- E. Thermal Management:
1. Solid state luminaire shall not exceed LED manufacturer's maximum junction temperature requirements when operated in-situ at luminaire manufacturer's maximum ambient operating temperature and 100% light output.
  2. Solid state luminaires shall be thermally protected using one of more of the following thermal management techniques:
    - a. Metal core board
    - b. Gap pad
    - c. Internal monitoring firmware
  3. Solid state luminaire housing shall be designed to transfer heat from the LED board to the outside environment.
- F. Power Supply/Driver requirements:
1. Power factor of 0.90 or greater for primary application
  2. Input current shall have Total Harmonic Distortion (THD) of less than 20%.
  3. Minimum operating temperature of minus 20 degrees Celsius or below when used in luminaires intended for outdoor applications.
  4. Output operating frequency to be equal to or greater than 120 Hz.
  5. Operate with sustained input variations of +/- 10% (voltage and frequency) with no damage to the driver.
  6. Tolerate sustained open circuit and short circuit output conditions without damage and without need for external fuses or trip devices.
  7. Output shall be regulated to +/- 5% across published load range.
  8. Class A sound rating.
  9. Outputs shall have current limiting protection.
  10. Operate LEDs at constant and regulated current levels. LEDs shall not be overdriven beyond the diode manufacturer's specified nominal voltage and current.
  11. Inrush currents not exceeding peak currents specified in NEMA 410.
- G. Solid State Lighting Controls:
1. Control interface to dimmable power supplies shall consist of one of the following:
    - a. Line Voltage Dimming. Controls to be rated for magnetic or electronic low voltage transformer operation.
    - b. Low voltage (0-10V) control. Controls to be compatible with either current sink or current source operation.
    - c. DMX control
  2. Dimmable LED power supplies shall use pulse width modulation (PWM) to regulate power to LEDs

- a. Dimmable power supplies shall have 12-bit or greater resolution to obtain flicker-free operation throughout the dimming range.

H. System Installation

1. Hardwired connections to solid state luminaires shall be reverse polarity protected and provide high voltage protection in the event connections are reversed or shorted during the installation process.
2. All solid state luminaires (100% of each lot) shall undergo a minimum eight-hour burn-in test during manufacturing. Solid state lighting installations shall be UL Listed as a low-voltage lighting system including, but not limited to, luminaire, power supply, controller, keypad, and wiring.

I. Warranty

1. Luminaires, drivers, and controllers for solid state lighting systems shall be covered by a five-year warranty against defects in workmanship or material. Warranty shall include in-warranty service program providing for payment of authorized labor charges incurred in replacement of inoperative in-warranty equipment.

**2.03 LUMINAIRE CONSTRUCTION**

- A. Sheet metal: materials and thicknesses shall be 20 gauge (0.7 mm or 0.027") min., free of dents, scratches, oil-can, or other defects.
- B. Painted luminaires: exposed weld marks, joints, and seams shall be filled and sanded smooth before finishing.
- C. All edges cleaned and dressed to remove sharp edges or burrs.
- D. Extrusions: 1/10" min. wall thickness, smooth and free of tooling lines, with cast end plates that exactly match extrusion profiles.
- E. Castings: smooth, free of pits, scales, gate marks, or blemishes.
- F. Spinnings shall have 1/32" min. thickness, smooth, free of spinning lines or blow-back, with clean edges.
- G. Welds: Follow recommendations of American Welding Society. All welds continuous and free of spatter, residue, or warping.
- H. No light leaks visible. Field paint exterior of housing with high temperature paint if necessary.
- I. Exposed end plates and joiners, with concealed fasteners.
- J. Hardware:
  1. Steel or aluminum exterior luminaires: stainless steel hardware.
  2. Stainless steel luminaires: stainless steel hardware.
  3. Copper alloy luminaires: brass hardware.
- K. Raceways: Where used for through wiring, luminaires must be approved for use as raceways.

**PART 3 - EXECUTION**

**3.01 INSTALLATION:**

- A. Refer to Section 26 27 00, Part 2.2, for wiring and splicing requirements.
- B. Underground cable installation shall conform to National Electrical Code except as otherwise specified or indicated.
- C. Contractor Damage: The Contractor shall promptly cause repairs to be made to any indicated utility lines or systems damaged by his operation.
- D. Under roads and paved areas, ducts shall be EPC-80-PVC polyvinyl chloride conduit.
- E. Cables shall be in one piece without splices between connections except where the distance exceeds the lengths in which the cable is furnished.

- F. Bends in cables shall have an inner radius of not less than 12 times the cable diameter.
- G. Horizontal slack of approximately 3 feet shall be left in the ground on each end of cable runs, on each side of connection and at all points where connections are to be made above ground level.
- H. Earthwork: Earthwork for electrical requirements shall conform to the requirements of Division 31.
- I. Coordinate work with other trades. Pre-ship anchor bolts and templates for use in preparing bases for installation. After leveling luminaires, pack grout between mounting plate and concrete footing. Provide weep holes to prevent accumulation of moisture inside pole base.

**3.02 TESTS**

- A. Test under provisions of Division 1, Section 26 08 00, and Section 26 51 01.
- B. The Owner shall be notified at least three working days in advance of the Contractor's proposed date of the tests to permit scheduling, and to permit witnessing of the tests. The Contractor shall furnish the Owner with three copies of the results of the tests.
- C. Circuits: The Contractor shall test each circuit, all controllers, and components of the system for proper operation. The Contractor shall furnish the Owner with three copies of the test results.
- D. Compaction Tests: Backfill shall be tested for compaction in accordance with ASTM D1556.
- E. Operating Test: Contractor shall operate the system in the presence of the Owner proving the proper operation.

**END OF SECTION**

## SECTION 26 5708

### LOW VOLTAGE NETWORK LIGHTING CONTROL SYSTEM

#### PART 1 - GENERAL

##### 1.01 SYSTEM DESCRIPTION

- A. Furnish all labor, materials, apparatus, tools, equipment transportation, temporary construction and commissioning services as indicated on the Drawings or described in these Specifications and as required to make a complete working facility lighting control system.
- B. Integrated Low Voltage Lighting Control System:
  - 1. The low voltage lighting control system shall consist of switches, digital occupancy sensors, daylighting sensors, room controllers, relay panels, wireless network bridges, wireless border routers, and LMCS system configuration software.
  - 2. The system shall accept program changes from the LMCS system configuration software for date and time, location, holidays, event scheduling, button binding and group programming.
- C. Requirements are indicated in Section 26 27 00 for raceways and electrical boxes and fittings required for installation of control equipment and wiring.
- D. Provide CBC 2013 compliant seismic installation. See Section 26 05 00 for all certification and submittal requirements.

##### 1.02 INCORPORATED DOCUMENTS

- A. Sections 26 05 00, 26 27 00, 26 51 01 and 26 56 01 apply to all Work in this Section.
- B. Drawings and general provisions of the Contract, including General and Supplementary Conditions and other Division 1 Specification Sections, apply to this Section.

##### 1.03 QUALITY ASSURANCE

- A. Manufacturer Qualifications: Company specializing in manufacturing of centralized and distributed lighting control systems with a minimum of 10 years documented experience.
- B. Installer Qualifications: Company certified by the manufacturer and specializing in installation of networked lighting control products with minimum three years documented experience.
- C. System Components: Demonstrate that individual components have undergone quality control and testing prior to shipping.
- D. System Support: Factory applications engineers shall be available for telephone support.
- E. NEC Compliance: Comply with NEC as applicable to electrical wiring Work.
- F. NEMA Compliance: Comply with applicable portions of NEMA standards pertaining to types of electrical equipment and enclosures.
- G. UL Approvals: Remote panels are to be UL listed under UL 916 Energy Management Equipment and/or UL 508 Industrial Control Equipment.
- H. CSA Approvals: Remote panels are to be CSA listed.
- I. FCC Emissions: All assemblies are to be in compliance with FCC emissions Standards specified in Part 15 Subpart J for commercial and residential application.
- J. All System components shall be California Title 24 compliant, where applicable.

##### 1.04 SUBMITTALS

- A. Submit under provisions of Section 01 33 00 and 26 05 00.
- B. Product Data: Manufacturer's data sheets on each product to be used, including:
  - 1. Catalog sheets and specifications.

2. Ratings, configurations, standard wiring diagrams, dimensions, colors, service condition requirements, and installed features.
  3. Storage and handling requirements and recommendations.
  4. Installation instructions.
- C. Shop Drawings: Wiring diagrams a for the various components of the System specified including:
1. Composite wiring and/or schematic diagram of each control circuit as proposed to be installed.
  2. Show location of all devices, including at minimum sensors, load controllers, and switches/dimmers for each area on reflected ceiling plans.
  3. Provide room/area details including products and sequence of operation for each room or area. Illustrate typical acceptable room/area connection topologies.
  4. Network riser diagram including floor and building level details. Include network cable specification. Illustrate points of connection to integrated systems. Coordinate integration with mechanical and/or other trades.
- D. Manufacturer's Certificates: Certify products meet or exceed specified requirements.
- E. Closeout Submittals:
1. Project Record Documents: Record actual installed locations and settings for lighting control devices.
  2. Operation and Maintenance Manual:
    - a. Include approved Shop Drawings and Product Data.
    - b. Include Sequence of Operation, identifying operation for each room or space.
    - c. Include manufacturer's maintenance information.
    - d. Operation and Maintenance Data: Include detailed information on device programming and setup.
    - e. Include startup and test reports.

#### **1.05 MANUFACTURERS**

- A. Integrated Low Voltage Lighting Control System:
1. The basis of the specified system is the Watt Stopper Digital Lighting Management (DLM) or an equal. Any other system to be considered must submit descriptive information 10 days prior to bid.
- B. Prior approval does not guarantee final approval by the electrical engineer. The contractor shall be completely responsible for providing a system meeting this specification in its entirety. All deviations from this specification must be listed and individually signed off by the engineer.
- C. The Owner reserves the right to reject a proposed substitution based on his agent's professional judgment as to the utility, visual appropriateness, or finish of substitutions.

#### **1.06 DELIVERY, STORAGE, AND HANDLING**

- A. Delivery: Deliver materials in Manufacturer's original, unopened, undamaged packages with intact identification labels.
- B. Storage and Protection: Store products in a clean, dry space in original manufacturer's packaging in accordance with manufacturer's written instructions until ready for installation

#### **1.07 GUARANTEE AND WARRANTIES**

- A. All Work performed under this Section must be guaranteed to be free of defects in products or workmanship for one year after date of acceptance by Owner, unless noted otherwise in General Conditions.



- B. Products Warranty: Manufacturer shall provide a 5 year limited warranty on products within this installation, except where otherwise noted, and consisting of a one for one device replacement.

## **PART 2 - PRODUCTS**

### **2.01 DISTRIBUTED DIGITAL LIGHTING CONTROL SYSTEM**

- A. Equipment Required: Lighting Control and Automation system as defined under this section covers the following equipment.
  - 1. Digital Lighting Management (DLM) local network: Free topology, plug-in wiring system (Cat 5e) for power and data to room devices.
  - 2. Wireless Network Bridge and Border Router: Provides Wireless Network Bridges that automatically create BACnet objects for all DLM devices on their local network (room) and communicate that information over a standalone wireless mesh 6LoWPAN network to a Border Router. The Border Router manages the formation and communication of the mesh network, and provides an ethernet network connection to upstream intelligent devices, such as a Segment Manager.
  - 3. Programming and Configuration Software: Optional PC-native application capable of accessing DLM control parameters within a room, for the local network, via a USB adapter, or globally, for many segment networks simultaneously, via BACnet/IP communication.
- B. Local Network LMRJ-Series: DLM local network is a free topology lighting control physical connection and communication protocol designed to control a small area of a building.
  - 1. Digital room devices connect to the local network using pre-terminated Cat 5e cables with RJ-45 connectors, which provide both data and power to room devices. Systems that utilize RJ-45 patch cords but do not provide serial communication data from individual end devices are not acceptable.
  - 2. If manufacturer's pre-terminated Cat5e cables are not used for the installation each cable must be individually tested and observed by authorized service representative following installation.

### **2.02 DIGITAL SWITCHES / DIMMERS**

- A. Description
  - 1. Two-way infrared (IR) transceiver for use with personal and configuration remote controls. Low voltage momentary pushbutton switches in 1, 2, 3, 4, 5 and 8 button configuration. Wall switches shall include the following features
  - 2. Removable buttons for field replacement with engraved buttons and/or alternate color buttons. Button replacement may be completed without removing the switch from the wall.
  - 3. Configuration LED indicator light on each switch that blinks to indicate data transmission.
  - 4. Load/Scene Status LED indicator light on each switch button with the following characteristics:
    - a. Bi-level LED
    - b. Dim locator level indicates power to switch
    - c. Bright status level indicates that load or scene is active
  - 5. Dimming switches shall include seven bi-level LEDs to indicate load levels using 14 steps.
  - 6. All digital parameter data programmed into an individual wall switch shall be retained in non-volatile FLASH memory within the wall switch itself. Memory shall have an expected life of no less than 10 years.
  - 7. Two RJ-45 ports for connection to DLM local network.

8. Multiple digital wall switches may be installed in a room by simply connecting them to the free topology DLM local network. No additional configuration shall be required to achieve multi-way switching.
  9. Switches shall be constructed of non-breakable Lexan on all exposed parts and shall include a matching screwless Lexan wall plate.
  10. Individual buttons shall be custom engraved with a maximum of 15 characters (including spaces) on two lines, where shown on plans.
  11. Multiple digital switches wired to control the same relay or relay group shall indicate the same status automatically.
- B. WattStopper product numbers: LMSW-101, LMSW-102, LMSW-103, LMSW-104, LMSW-105, LMSW-108, LMDM-101.

### **2.03 DIGITAL OCCUPANCY SENSORS**

- A. Description
1. Digital Occupancy Sensors - Self-configuring, digitally addressable and calibrated occupancy sensors with LCD display and two-way active infrared (IR) communications.

### **2.04 DIGITAL PHOTSENSORS**

- A. Description
1. Digital Photosensors - Single-zone closed loop, multi-zone open loop and dual-loop daylighting sensors with two-way active infrared (IR) communications can provide switching, bi-level, tri-level or dimming control for daylight harvesting.

### **2.05 DIGITAL DIMMING / SWITCHING ROOM CONTROLLERS**

- A. Description
1. Digital controllers for lighting and plug loads automatically bind the room loads to the connected devices in the space without commissioning or the use of any tools. Room and plug load controllers shall be provided to match the room lighting and plug load control requirements. The controllers will be simple to install, and will not have dip switches or potentiometers, or require special configuration for standard Plug n' Go applications. The control units will include the following features.
  2. Automatic room configuration to the most energy-efficient sequence of operation based upon the devices in the room.
  3. Simple replacement - Using the default automatic configuration capabilities, a room controller may be replaced with an off-the-shelf.
  4. Multiple room controllers connected together in a local network must automatically prioritize each room controller, without requiring any configuration or setup, so that loads are sequentially assigned using room controller device ID's from highest to lowest.
  5. Device Status LEDs to indicate:
    - a. Data transmission
    - b. Device has power
    - c. Status for each load
    - d. Configuration status
    - e. Quick installation features including:
      - 1) Standard junction box mounting
      - 2) Quick low voltage connections using standard RJ-45 patch cable
    - f. Based on individual configuration, each load shall be capable of the following behavior on power up following the loss of normal power:
      - 1) Turn on to 100%
      - 2) Remain off
      - 3) Turn on to last level

- g. Each load shall be configurable to operate in the following sequences based on occupancy:
    - 1) Auto-on/ Auto-off (Follow on and off)
    - 2) Manual-on/ Auto-off (Follow off only)
  - h. The polarity of each load output shall be reversible, via digital configuration, so that on is off and off is on.
  - i. BACnet object information shall be available for the following objects:
    - 1) Load status
    - 2) Electrical current
    - 3) Total watts per controller
    - 4) Schedule state - normal or after-hours
    - 5) Demand response control and cap level
    - 6) Room occupancy status
    - 7) Total room lighting and plug loads watts
    - 8) Total room watts/sq ft
    - 9) Force on/off all loads
  - j. UL 2043 plenum rated
  - k. Manual override and LED indication for each load
  - l. Dual voltage (120/277 VAC, 60 Hz), or 347 VAC, 60 Hz (selected models only). 120/277 volt models rated for 20A total load, derating to 16A required for some dimmed loads (forward phase dimming); 347 volt models rated for 15A total load; plug load controllers carry application-specific UL 20 rating for receptacle control.
  - m. Zero cross circuitry for each load
  - n. All digital parameter data programmed into an individual room controller or plug load controller shall be retained in non-volatile FLASH memory within the controller itself. Memory shall have an expected life of no less than 10 years.
- B. On/Off Room Controllers shall include:
- 1. One or two relay configuration
  - 2. Efficient 150 mA switching power supply
  - 3. Three RJ-45 DLM local network ports with integral strain relief and dust cover
  - 4. WattStopper product numbers: LMRC-101, LMRC-102
- C. On/Off/Dimming enhanced Room Controllers shall include:
- 1. Real time current monitoring
  - 2. Multiple relay configurations
    - a. One, two or three relays (LMRC-21x series)
    - b. One or two relays (LMRC-22x series)
    - c. Efficient 250 mA switching power supply
    - d. Four RJ-45 DLM local network ports with integral strain relief and dust cover
    - e. One dimming output per relay
      - 1) 0-10V Dimming - Where indicated, one 0-10 volt analog output per relay for control of compatible ballasts and LED drivers. The 0-10 volt output shall automatically open upon loss of power to the Room Controller to assure full light output from the controlled lighting. (LMRC-21x series)
      - 2) Line Voltage, Forward Phase Dimming - Where indicated, one forward phase control line voltage dimming output per relay for control of compatible two-wire or three-wire ballasts, LED drivers, MLV, forward phase compatible ELV, neon/cold cathode and incandescent loads. (LMRC-22x series)
      - 3) Each dimming output channel shall have an independently configurable minimum and maximum calibration trim level to set the dimming range to match the true dynamic range of the connected ballast or driver.

- 4) The LED level indicators on bound dimming switches shall utilize this new maximum and minimum trim.
  - 5) Each dimming output channel shall have an independently configurable minimum and maximum trim level to set the dynamic range of the output within the new 0-100% dimming range defined by the minimum and maximum calibration trim.
  - 6) Calibration and trim levels must be set per output channel.
  - 7) Devices that set calibration or trim levels per controller are not acceptable.
  - 8) All configuration shall be digital. Devices that set calibration or trim levels per output channel via trim pots or dip-switches are not acceptable.
  - f. Each load shall have an independently configurable preset on level for Normal Hours and After Hours events to allow different dimmed levels to be established at the start of both Normal Hours and After Hours events.
  - g. Fade rates for dimming loads shall be specific to bound switch buttons, and the load shall maintain a default value for any bound buttons that do not specify a unique value.
  - h. The following dimming attributes may be changed or selected using a wireless configuration tool:
    - 1) Establish preset level for each load from 0-100%
    - 2) Set high and low trim for each load
    - 3) Set lamp burn in time for each load up to 100 hours
  - i. Override button for each load provides the following functions:
    - 1) Press and release for on/off control
    - 2) Press and hold for dimming control
  - j. WattStopper product numbers: LMRC-211, LRMC-212, LRMC-213, LMRC-221, LMRC-222
- D. Plug Load Room Controllers shall include:
1. One relay configuration with additional connection for unswitched load
  2. Configurable additive time delay to extend plug load time delay beyond occupancy sensor time delay (e.g. a 10 minute additive delay in a space with a 20 minute occupancy sensor delay ensures that plug loads turn off 30 minutes after the space is vacated).
  3. Factory default operation is Auto-on/ Auto-off, based on occupancy
  4. Real time current monitoring of both switched and un-switched load (LMPL-201 only)
  5. Efficient switching power supply
    - a. 150mA (LMPL-101)
    - b. 250mA (LMPL-201)
    - c. RJ-45 DLM local network ports
      - 1) Three RJ-45 ports (LMPL-101)
      - 2) Four RJ-45 ports (LMPL-201)
    - d. WattStopper product numbers: LMPL-101, LMPL-201.

## 2.06 CONFIGURATION TOOLS

- A. A wireless configuration tool facilitates optional customization of DLM local networks using two-way infrared communications, while PC software connects to each local network via a USB interface.
- B. Features and functionality of the wireless configuration tool shall include but not be limited to:
  1. Two-way infrared (IR) communication with DLM IR-enabled devices within a range of approximately 30 feet.
  2. High visibility organic LED (OLED) display, pushbutton user interface and menu-driven operation.

3. Must be able to read and modify parameters for room controllers, occupancy sensors, wall switches, daylighting sensors, network bridges and relay panels, and identify room devices by type and serial number.
4. Save up to eight occupancy sensor setting profiles, and apply profiles to selected sensors.
5. Temporarily adjust light level of any load(s) on the local network, and incorporate those levels in scene setting. Set room mode for testing of Normal Hours (NH) and After Hours (AH) parameter settings.
6. Adjust or fine-tune daylighting settings established during auto-configuration, and input light level data to complete configuration of open loop daylighting controls.
7. Set room mode for testing of Normal Hours (NH) and After Hours (AH) parameter settings.
8. Verify status of building level network devices.

C. WattStopper Product Numbers: LMCT-100, LMCI-100/LMCS-100

## 2.07 NETWORK BRIDGE

- A. The network bridge module connects a DLM local network to a BACnet-compliant segment network for communication between rooms, relay panels and a segment manager or BAS. Each local network shall include a network bridge component to provide a connection to the local network room devices. The network bridge shall use industry standard BACnet MS/TP network communication and an optically isolated EIA/TIA RS-485 transceiver.
1. The network bridge shall be provided as a separate module connected on the local network through an available RJ-45 port.
  2. Provide Plug n' Go operation to automatically discover room devices connected to the local network and make all device parameters visible to the segment manager via the segment network. No commissioning shall be required for set up of the network bridge on the local network.
  3. The network bridge shall automatically create standard BACnet objects for selected room device parameters to allow any BACnet-compliant BAS to include lighting control and power monitoring features as provided by the DLM room devices on each local network. BACnet objects will be created for the addition or replacement of any given in-room DLM device for the installed life of the system. Products requiring that an application-specific point database be loaded to create or map BACnet objects are not acceptable. Systems not capable of providing BACnet data for control devices via a dedicated BACnet Device ID and physical MS/TP termination per room are not acceptable. Standard BACnet objects shall be provided as follows:
    - a. Read/write the normal or after hours schedule state for the room
    - b. Read the detection state of each occupancy sensor
    - c. Read the aggregate occupancy state of the room
    - d. Read/write the On/Off state of loads
    - e. Read/write the dimmed light level of loads
    - f. Read the button states of switches
    - g. Read total current in amps, and total power in watts through the room controller
    - h. Read/write occupancy sensor time delay, PIR sensitivity and ultrasonic sensitivity settings
    - i. Activate a preset scene for the room
    - j. Read/write daylight sensor fade time and day and night setpoints
    - k. Read the current light level, in footcandles, from interior and exterior photosensors and photocells
    - l. Set daylight sensor operating mode
    - m. Read/write wall switch lock status
    - n. Read watts per square foot for the entire controlled room

- o. Write maximum light level per load for demand response mode
- p. Read/write activation of demand response mode for the room
- q. Activate/restore demand response mode for the room

B. WattStopper product numbers: LMBC-300

## 2.08 SEGMENT MANAGER

- A. For networked applications, the Digital Lighting Management system shall include at least one segment manager to manage network communication. It shall be capable of serving up a graphical user interface via a standard web browser utilizing either unencrypted TCP/IP traffic via a configurable port (default is 80) or 256 bit AES encrypted SSL TCP/IP traffic via a configurable port (default is 443).
- B. Each segment manager shall have integral support for at least three segment networks. Segment networks may alternately be connected to the segment manger via external routers and switches, using standard Ethernet structured wiring. Each router shall accommodate one segment network. Provide the quantity of routers and switches as shown on the plans.
- C. Operational features of the Segment Manager shall include the following:
  - 1. Connection to PC or LAN via standard Ethernet TCP/IP via standard Ethernet TCP/IP with the option to use SSL encrypted connections for all traffic.
  - 2. Easy to learn and use graphical user interface, compatible with Internet Explorer 8, or equal browser. Shall not require installation of any lighting control software to an end-user PC.
  - 3. Log in security capable of restricting some users to view-only or other limited operations.
  - 4. Automatic discovery of DLM devices and relay panels on the segment network(s). Commissioning beyond activation of the discovery function shall not be required to provide communication, monitoring or control of all local networks and lighting control panels.
  - 5. After discovery, all rooms and panels shall be presented in a standard navigation tree format. Selecting a device from the tree will allow the device settings and operational parameters to be viewed and changed by the user.
  - 6. Ability to view and modify room device operational parameters. It shall be possible to set device parameters independently for normal hours and after hours operation including sensor time delays and sensitivities, and load response to sensor including Manual-On or Auto-On.
  - 7. Ability to set up schedules for rooms and panels, view and override current status of panel channels and relays, and assign relays to groups. Schedules shall automatically set controlled zones or areas to either a normal hours or after hours mode of operation. Support for a minimum of 100 unique schedules, each with up to four time events per day. Support for annual schedules, holiday schedules and unique date-bound schedules.
  - 8. Ability to group rooms and loads for common control by schedules, switches or network commands.
  - 9. Ability to monitor connected load current and display power consumption for areas equipped with room controllers incorporating the integral current monitoring feature.
  - 10. Provide capabilities for integration with a BAS via BACnet protocol. At a minimum, the following points shall be available to the BAS via BACnet IP connection to the segment manager: room occupancy state; room schedule mode; room switch lock control; individual occupancy sensor state; room lighting power; room plug-load power; load ON/OFF state; load dimming level; panel channel schedule state; panel relay state; and Segment Manager Group schedule state control.
  - 11. The Segment Manager shall allow access and control of the overall system database via Native Niagara AX FOX connectivity. Systems that must utilize a Tridium Niagara

controller in addition to the programming, scheduling and configuration server are not acceptable.

- D. Segment Manager shall support multiple DLM rooms as follows:
  - 1. Support up to 120 network bridges and 900 digital in-room devices (LMSM-3E).
  - 2. Support up to 300 network bridges and 2,200 digital in room devices, connected via network routers and switches (LMSM-6E).
- E. WattStopper Product Numbers: LMSM-3E, LMSM-6E, NB-ROUTER, NB-SWITCH, NB-SWITCH-8, NB-SWITCH-16.

## 2.09 PROGRAMMING, CONFIGURATION AND DOCUMENTATION SOFTWARE

- A. PC-native application for optional programming of detailed technician-level parameter information for all DLM products, including all parameters not accessible via BACnet and the handled IR configuration tool. Software must be capable of accessing room-level parameter information locally within the room when connected via the optional LMCI-100 USB programming adapter, or globally for many segment networks simultaneously utilizing standard BACnet/IP communication.
- B. Additional parameters exposed through this method include but are not limited to:
  - 1. Occupancy sensor detection LED disable for performance and other aesthetic spaces where blinking LEDs present a distraction.
  - 2. Six occupancy sensor action behaviors for each controlled load, separately configurable for normal hours and after hours modes. Modes include: No Action, Follow Off Only, Follow On Only, Follow On and Off, Follow On Only with Override Time Delay, Follow Off Only with Blink Warn Grace Time, Follow On and Off with Blink Warn Grace Time.
  - 3. Separate fade time adjustments per load for both normal and after hours from 0 - 4 hours.
  - 4. Configurable occupancy sensor re-trigger grace period from 0 - 4 minutes separate for both normal hours and after hours.
  - 5. Separate normal hours and after hours per-load button mode with modes including: Do nothing, on only, off only, on and off.
  - 6. Load control polarity reversal so that on events turn loads off and vice versa.
  - 7. Per-load DR (demand response) shed level in units of percent.
  - 8. Load output pulse mode in increments of 1second.
  - 9. Fade trip point for each load for normal hours and after hours that establishes the dimmer command level at which a switched load closes its relay to allow for staggered On of switched loads in response to a dimmer.
- C. Generation of reports at the whole file, partial file, or room level. Reports include but are not limited to:
  - 1. Device list report: All devices in a project listed by type.
  - 2. Load binding report: All load controller bindings showing interaction with sensors, switches, and daylighting.
  - 3. BACnet points report: Per room Device ID report of the valid BACnet points for a given site's BOM.
  - 4. Room summary report: Device manifest for each room, aggregated by common BOM, showing basic sequence of operations.
  - 5. Device parameter report: Per-room lists of all configured parameters accessible via hand held IR programmer for use with O&M documentation.
  - 6. Scene report: All project scene pattern values not left at defaults (i.e. 1 = all loads 100%, 2 = all loads 75%, 3 = all loads 50%, 4 = all loads 25%, 5-16 = same as scene 1).
  - 7. Occupancy sensor report: Basic settings including time delay and sensitivity(ies) for all occupancy sensors.

- D. Network-wide programming of parameter data in a spreadsheet-like programming environment including but not limited to the following operations:
  - 1. Set, copy/paste an entire project site of sensor time delays.
  - 2. Set, copy/paste an entire project site of sensor sensitivity settings.
  - 3. Search based on room name and text labels.
  - 4. Filter by product type (i.e. LMRC-212) to allow parameter set by product.
  - 5. Filter by parameter value to search for product with specific configurations.
- E. Network-wide firmware upgrading remotely via the BACnet/IP network.
  - 1. Mass firmware update of entire rooms.
  - 2. Mass firmware update of specifically selected rooms or areas.
  - 3. Mass firmware upgrade of specific products.
- F. WattStopper Product Number: LMCS-100, LMCI-100

### **PART 3 - EXECUTION**

#### **3.01 PREPARATION**

- A. Do not begin installation until measurements have been verified and work areas have been properly prepared.
- B. If preparation is the responsibility of another installer, notify Architect of unsatisfactory preparation before proceeding.

#### **3.02 PRE-INSTALLATION MEETING**

- A. Manufacturer shall provide a factory authorized representative to provide a functional overview of the lighting control system prior to products being installed.
  - 1. Discuss functionality and integration of all products per design requirements.
  - 2. Confirm location of occupancy sensors and photocells as required.
  - 3. Confirm low voltage control wires meet specification.
  - 4. Explain adjustment options and verify specification requirements for each device.

#### **3.03 INSTALLATION**

- A. Install system in accordance with the approved system shop drawings and manufacturer's instructions.
- B. Install all room/area devices using manufacturer's factory-tested Cat 5e cable with pre-terminated RJ-45 connectors.
  - 1. If pre-terminated cable is not used for room/area wiring, each field-terminated cable shall be tested following installation and testing results submitted to the Manufacturer's Representative for approval prior to proceeding with the Work.
  - 2. If fixtures have internal DLM Control Modules, ensure that they are also connected with Cat 5e cable.
  - 3. Install all room to room network devices using manufacturer-supplied LM-MSTP network wire or wireless devices. Network wire substitution is not permitted and may result in loss of product warranty.
  - 4. Low voltage wiring topology must comply with manufacturer's specifications.
  - 5. Route network wiring as indicated on the Drawings as closely as possible. Document final wiring location, routing and topology on as built drawings.
- C. All line voltage connections shall be tagged to indicate circuit and switched legs.
- D. Test all devices to ensure proper communication.
- E. Calibrate all sensor time delays and sensitivity to guarantee proper detection of occupants and energy savings. Adjust time delay so that controlled area remains lighted while occupied.



- F. Provide written or computer-generated documentation on the configuration of the system including room by room description including:
  - 1. Sensor parameters, time delays, sensitivities, and daylighting setpoints.
  - 2. Sequence of operation, (e.g. manual ON, Auto OFF. etc.)
  - 3. Load Parameters (e.g. blink warning, etc.)
- G. Post start-up tuning - Adjust sensor time delays and sensitivities to meet the Owner's requirements 30 days from beneficial occupancy. Provide a detailed report to the Architect / Owner of post start-up activity.
- H. Tighten all panel Class I conductors from both circuit breaker and to loads to torque ratings as marked on enclosure UL label.
- I. All Class II cabling shall enter enclosures from within low-voltage wiring areas and shall remain within those areas. No Class I conductors shall enter a low-voltage area.
- J. Run separate neutrals for any phase dimmed branch load circuit. Different types of dimming loads shall have separate neutral.
- K. Verify all non-panel-based lighting loads to be free from short circuits prior to connection to room controllers.

### **3.04 FIELD QUALITY CONTROL**

- A. Manufacturer's Field Service: Engage a factory-authorized service representative to inspect components, assemblies, and equipment installations, including connections, and to assist in testing. Notify Architect and Manufacturer in writing a minimum of 3 weeks prior to system start-up and testing.
- B. Tests and Inspections: Manufacturer's service representative shall perform the following inspections and prepare reports.
  - 1. Verify Class I and II wiring connections are terminated properly by validating system performance.
  - 2. Set IP addresses and other network settings of system front end hardware per facilities IT instructions.
  - 3. Verify / complete task programming for all switches, dimmers, time clocks, and sensors.
  - 4. Verify that the control of each space complies with the Sequence of Operation.
  - 5. Correct any system issues and retest..
- C. Provide a report in table format with drawings, or using a software file that can be opened in the manufacturer's system software including each room or space that has lighting control installed. Indicate the following:
  - 1. Date of test or inspection.
  - 2. Loads per space, or Fixture Address identification.
  - 3. Quantity and Type of each device installed
  - 4. Reports providing each device's settings.

### **3.05 TRAINING**

- A. Manufacturer shall provide factory authorized application engineer to train Owner personnel in the operation and programming of the lighting control system for the first (2) two days of occupancy; then (1) one week later, and again (1) month later.

### **3.06 PRODUCT SUPPORT AND SERVICE**

- A. Factory telephone support shall be available at no cost to the Owner following acceptance. Factory assistance shall consist of assistance in solving application issues pertaining to the control equipment.

### 3.07 TESTS

- A. Test under provisions of Section 26 05 00 and 26 08 00.
- B. The Owner shall be notified at least three working days in advance of the Contractor's proposed date of the tests to permit scheduling, and to permit witnessing of the tests. The Contractor shall furnish the Owner with three copies of the results of the tests.
- C. Circuits: The Contractor shall test each circuit, all controllers, and components of the system for proper operation. The Contractor shall furnish the Owner with three copies of the test results.
- D. Operating Test: Contractor shall operate the system in the presence of the Owner proving the proper operation of the system and all components.

**END OF SECTION**

**SECTION 27 0000**  
**TELECOMMUNICATIONS SYSTEM**

**PART 1 - GENERAL**

**1.01 DESCRIPTION**

- A. This project includes the provisions for and installation of a complete telecommunications system pathways and wiring infrastructure system for the facility, including all terminations, testing, and all related passive components required for operation.

**1.02 WORK INCLUDED**

- A. Work included in this Section: All materials, labor, equipment, services, and incidentals necessary to install the work as shown on the drawings and as specified hereinafter, including, but not limited to the work listed below.
- B. Provide and install a complete and functional data communication system, including voice services via VoIP capability, and all necessary passive components, to allow full operation of the wiring infrastructure system upon completion.
- C. The installation shall include all optical fiber, twisted pair copper, inner-duct, conduit, fiber interconnect / patching equipment, copper interconnect / patching equipment, fiber connectors, copper connectors, fusion splices, fiber patch cords / jumpers, copper patch cords / jumpers, wiring blocks, data outlets, wi-fi access points, and any other equipment specified herein.
- D. The installation shall not include any active network components such as routers, switches, hubs, fiber optic transceivers, wireless communications system transceivers, antennae, base stations and concentrators or servers, which shall be supplied by the owner.
- E. Upon completion of the installation, this contractor shall test all fiber and copper pathways and record the test results as specified herein. Test results must be delivered to the owner upon completion of project
- F. The scope of work under this Section shall include any other work as might reasonably be implied as required, even though not specifically mentioned herein or shown on the drawings.
- G. Provide CBC 2019 compliant seismic installation. See Section 26 05 00 for all certification and submittal requirements.

**1.03 RELATED WORK**

- A. Division 1 - General Requirements.
- B. Division 9 - Finishes.
- C. Section 26 05 00 - Basic Electrical Requirements
- D. Section 26 27 00 - Basic Electrical Materials & Methods
- E. Equipment and work provided by the owner's network integrator, including owner provided network servers, switches, hubs, optical fiber transceivers, routers, wireless communication system equipment, etc.

**1.04 INCORPORATED DOCUMENTS**

- A. Requirements of the General Conditions, supplementary conditions, and Division 1 Sections apply to the work of this section, unless modified herein.
- B. Published specifications, standard tests or recommended methods of trade, industry or government organizations shall apply to work of this section where cited by abbreviations noted below, unless modified herein.
  - 1. National Electrical Code, latest edition, (NEC), Article 800

2. ANSI/TIA-492.AAAC-B - Detail Specification for 850-nm Laser-Optimized, 50-um Core Diameter/125-um Cladding Diameter Class 1a Graded-Index Multimode Optical Fibers
3. ANSI/TIA-492.AAAD - Detail Specification for 850-nm Laser- Optimized, 50-um Core Diameter/125-um Cladding Diameter Class 1a Graded-Index Multimode Optical Fibers Suitable for Manufacturing OM4 Cabled Optical Fiber
4. ANSI/TIA-492.CAAB - Detail Specification for Class IVa Dispersion-Unshifted Single-Mode Optical Fibers with Low Water Peak; Current Edition
5. ANSI/TIA-568.0-D - Generic Communications Cabling for Customer Premises
6. Underwriters' Laboratories, Inc. (UL), UL 1459, UL 1863.
7. ANSI/TIA-568.1-D "Commercial Building Communications Cabling Standard"
8. ANSI/TIA-568.3-D "Optical Fiber Cabling and Components Standard"
9. ANSI/TIA-569-D "Telecommunications Pathways and Spaces"
10. ANSI/TIA-568-C.2-1. "Balanced Twisted-Pair Telecommunications Cabling and Components Standard"
11. ANSI/TIA-606-B.1 - Administration Standard for the Commercial Telecommunications Infrastructure
12. ANSI/TIA-607-C - Generic Telecommunications Bonding and Grounding (Earthing) for Customer Premises
13. ANSI/TIA-862-B - Structured Cabling Infrastructure Standard for Intelligent Building Systems
14. ANSI/TIA-942-A - Telecommunications Infrastructure Standard for Data Centers
15. BICSI - TDMM, Building Industries Consulting Services International, Telecommunications Distribution Methods Manual (TDMM)
16. IEEE 802.3 "Carrier Sense Multiple Access With Collision Detection".
17. IEEE 802.11b "Wireless Network standard"
18. Owner's telecommunications Standards and Requirements.

#### 1.05 CONTRACTOR QUALIFICATIONS

- A. Contractor must possess a valid state Contractor's License and must have successfully performed at least three projects of similar scope, within two years of the date of this bid. Proof of performance shall be in the form of reference sheets, which shall include a brief description of the project, the beginning and ending contract price, the project foreman or superintendent's name, and the name, address, and telephone number of a project contact.
- B. Contractor must be able to prove to the satisfaction of Owner that it has significant experience in the installation of optical fiber cable systems. Installation must include installation of optical fiber cable, fiber termination, fiber fusion splicing (where pre-approved), knowledge of interconnect equipment, and a thorough knowledge of testing procedures. Contractor must provide a minimum of three references supporting its claim of experience for similar projects within the two years prior to this bid. Documentation must be included with the bid documents submitted.
- C. Contractor must have been in business and in the business of installing telecommunications systems, continuously, for a period of at least three years, prior to the date of this bid.

#### 1.06 SUBMITTALS

- A. General: Comply with the requirements of Section 26 05 00 - Submittals.
- B. Submit complete list of all items of materials to be furnished, and installed to the owner for compliance review prior to purchasing the materials. Submittals shall include:
  1. Complete bill of materials and equipment, including a complete listing of the characteristics of the equipment as specified.
  2. One line diagram indicating all system connections, all closet locations, rack arrangements, cabinets, and workstation outlets.

3. Rack and communications cabinet layouts and dimensions.
  4. Samples of proposed cable markers and labeling, and patch panel labeling and color-coding.
  5. List of instrumentation to be used for system testing, including certificate of manufacturer's calibration.
  6. ¼ scale plan of all telecommunications rooms and closets, indicating proposed layout of all equipment and cable trays, troughs, and runways.
  7. Manufacturer's warranty application for the indicated project.
  8. Schedule of work completion coordinated with the General Contractor.
- C. Submit Contractor's qualifications as outlined in Section 1.5 above.
- D. Submit "as-built" record drawings at the completion of the installation and testing.
- E. The Contractor shall submit all testing documentation prior to acceptance of the work by the Owner.
- F. Contractor shall submit to the Owner, in writing, 48 hours advance notice when testing of optical fiber cable will begin.

### 1.07 GENERAL REQUIREMENTS

- A. The telecom communications system shall consist of three components:
1. An optical fiber backbone.
  2. Twisted pair copper voice and data cabling.
  3. Twisted pair copper cabling for wireless access points.
- B. Each building shall be connected via a single multi-strand single mode optical fiber cable (or composite single mode/multimode cable where indicated on the drawings) to the campus MDF. Individual Intermediate Distribution Frames (IDF) shall be located as indicated on the Drawings for additional termination/patching of horizontal copper station cabling. Each optical fiber cable shall originate at the campus MDF and shall be terminated at its respective IDF.
- C. All optical fiber cables shall be enclosed in innerduct installed in conduit.
- D. All copper backbone cables shall be routed along with the fiber cable, shall originate at the MDF, and shall terminate in their respective IDF.
- E. From each IDF, one or more twisted-pair copper cables shall be routed to each data outlet location, and to each wireless antenna location, as indicated on the drawings.
1. The wiring system shall be provided and installed per TIA / EIA-568 wiring topology and shall be Category 6A rated.
  2. Unshielded twisted pair (UTP) cable, installed for high-speed data application, shall not exceed 295 feet in length between terminations.
- F. Terminations:
1. All fiber strands shall be terminated with connectors and land on fiber interconnect equipment. No splices. If splices are required (with pre-approval), all splices shall be fusion type.
  2. All data cables and wireless communications cables shall be terminated on modular patch panels.
  3. All voice cables shall be terminated on modular patch panels, or on wiring blocks where indicated on the drawings.
  4. All active equipment will be provided and installed by the owner.
- G. The MDF and IDF will also house active data distribution equipment provided by the owner, possibly including but not limited to local area network hubs and switches, optical fiber transceivers, wireless communication systems base stations and concentrations routers, and

servers. This Contractor shall coordinate with Owner's network integrator to ensure that data rack and cabinet layouts fully accommodate all owner-provided equipment.

### **1.08 FUNCTION AND OPERATION**

- A. The function of the data communications cable system is to transmit data signals from a central location to multiple individual data outlet locations. Upon completion of the work outlined in this specification, the entire cable system, including cable, and communications outlets shall be tested to (and meet) Category 6A compliance.
  - 1. Horizontal UTP Category 6A 23AWG copper cabling system shall be guaranteed to exceed all TIA-568-C.2 link and channel performance requirements and be capable of supporting 10G Base-T (802.3an) and ISO/IEC 11801 Class EA applications for a total distance of 100 meters with equipment cords. System shall be guaranteed to meet all Cat 6A requirements for short links and channels down to a 10 foot link (5 meter channel) with a guaranteed 4 dB margin of Alien Crosstalk.
  - 2. Upon completion of the work, the multimode optical fiber cable system (if multimode is used on this project) shall be capable of 10 Gb/s data rates over a distance of 300 meters and of transmitting signals with a minimum bandwidth of 200 MHz at both 850 and 1300nm. The cumulative signal loss, through connectors, jumpers, couplers, and fiber cable, shall be less than 10 dB.
- B. Upon completion of the work, the single mode optical fiber cable system shall be capable of transmitting signals with a bandwidth of up to 500 MHz at both 1310 and 1550 nm. The cumulative signal loss, through connectors, jumpers, couplers, and fiber cable, shall be less than 10dB.

### **1.09 GUARANTEE**

- A. The Cabling System shall meet the performance requirements of the ANSI/TIA/EIA-568-C.2 standard. The warranty on the material, services, and operation of the cabling system to this specification must be for a period of at least 15 years. The connecting hardware shall have a lifetime extended warranty against defects in material and workmanship.
- B. The warranty must include the following statements regarding the cabling system:
  - 1. "Will support and conform to TIA/EIA-568-C.2 specifications covering any current or future application which supports transmission over a properly constructed horizontal cabling system premises network which meets the channel and/or basic link performance as described in TIA/EIA-568-C".
  - 2. "Will be free from defects in material or faulty workmanship for the entire warranty period".
  - 3. The Contractor shall apply for a warranty from the manufacturer within 60 days from end of project. In order to achieve a warranty the contractor must be in good standing with current training records on file.

## **PART 2 - PRODUCTS**

### **2.01 ACCEPTABLE MANUFACTURERS**

- A. Copper & Fiber Cable
  - 1. BerkTek, Superior Essex, Avaya, Sycor, or equal
- B. Fiber Optic Distribution Panels and Interconnects
  - 1. Leviton, ADC Telecommunications, Sycor, or equal
- C. Copper Patch Panels and Devices
  - 1. Ortronics, Leviton, Avaya, Ortronics, Siemon, or equal
- D. Cabinets and Racks
  - 1. Ortronics, ESW (Encore), Leviton, Homaco, Chatsworth, or equal
- E. Innerduct

- 1. Eastern, Endot, or equal
- F. Firestopping
  - 1. STI (Specified Technologies, Inc.), 3M, or equal
- G. Steel Wire Cable Tray:
  - 1. Cablofil, Mono-Mesh, GS Metals, or equal
- H. Cable Runway:
  - 1. Cablofil, B-Line, Chatsworth, Mono-System Inc, or equal
- I. Fiber Optic Cable Trough:
  - 1. Ortronics, ADC Telecommunications, or equal

**2.02 SYSTEM PERFORMANCE**

- A. Category 6A (CAT6A) Unshielded Twisted Pair (UTP) Systems
  - 1. Category 6A 23AWG UTP copper cabling system shall be guaranteed to exceed all TIA-568 link and channel performance requirements and be capable of supporting 10G Base-T (802.3an) and ISO/IEC 11801 Class EA applications for a total distance of 100 meters with equipment cords. System shall be guaranteed to meet all CAT6A requirements for short links and channels down to a 10 foot link (5 meter channel) with a guaranteed 5 dB margin of Alien Crosstalk.
  - 2. Basis of Design is Berk-Tek Leviton Technologies CX6850 Cat6A Premium UTP System, or approved equal.
  - 3. Category 6A Performance Parameters, headroom over TIA-568 standard:

INSERTION LOSS	NEXT	PSNEXT	ACR-F (ELFEXT)	PSACR-F (ESELFEXT)
3%	5DB	6DB	10DB	10DB

RETURN LOSS	ACR-N	PSACR	PSANEXT	PSAACR-F
4DB	7DB	7DB	5DB	11DB

- A. Connectors
  - 1. Provide mission-critical, modular-type, information connectors/outlets (jacks) for 23-24 AWG copper cable. These connectors shall be individual snap-in style, and exceed compliance with TIA-568 specifications. The connectors shall comply with the following:
    - a. Shall be 8-position 8-conductor (8P8C) "RJ45"-style modular jack, Category 6 (CAT6) and Category 6A (CAT6A), with IDC terminals, T568A/B wiring scheme (use T568B), and utilize a non-punchdown simplified manual termination style.
    - b. Shall be encased in a die-cast housing to protect from potential EMI/RFI, and utilize a universal Keystone-style insertion footprint as the manufacturer's main "flagship" line of products.
    - c. CAT6A connectors shall exceed all component performance requirements for Augmented Category 6 in the ANSI/TIA-568 standard, as well as Class EA requirements as described in ISO/IEC 11801, from 1 MHz to 500 MHz to support the IEEE 802.3an standard for 10GBASE-T network performance.
    - d. CAT6 Connectors shall exceed all component performance requirements for Category 6 in the ANSI/TIA-568-C.2 standard, as well as Class E requirements as described in ISO/IEC 11801, from 1 MHz to 250 MHz. Shielded connectors shall utilize the same form factor, design, and tool-less installation process as the unshielded connectors in the product line.

- e. Shall be tested by an Independent testing body such as Intertek (ETL) for component compliance (i.e. "Component rated") to ANSI/TIA-568 and for POE+ applications. Test results shall be published and publicly available without special request.

## 2.03 MATERIALS

### A. Copper Cable:

1. Inter-building outside-plant cable shall be multi-pair unshielded twisted pair type, #23 AWG, Superior Essex type ANMA or equal. The wiring shall comply with the following:
  - a. Maximum DC resistance: 26.5 Ohms Per 1000 feet
  - b. Maximum mutual capacitance at 1 kHz: 15.7 nF per 1000 feet
  - c. Nominal attenuation @ 1 MHz: 6.7 db per 1000 feet
  - d. Characteristic impedance @ 1.0 Hz: 1.0 MHz: 100 Ohms (+) 15%
2. Interior backbone cable shall be multi-pair unshielded twisted pair type, #23 AWG, Superior Essex AR Series Riser Cable type ARMM or equal. The cable sheath shall be armored and riser-rated (CMR). The cable shall meet ANSI / TIA / EIA-568 standards for 100 ohm category 3 UTP multi-pair backbone cable and also comply with the following:
  - a. Maximum DC resistance: 26.5 Ohms per 1000 feet
  - b. Maximum mutual capacitance at 1 kHz: 15.7 nF per 1000 feet
  - c. Nominal attenuation @ 1 MHz: 7.6 db per 1000 feet
  - d. Characteristic impedance @ 1.0 - 16.0 MHz: 100 Ohms, (+) 15%
3. Inter-building and interior backbone cable shall meet the following requirements.
  - a. Cable Conductors specifications:
    - 1) 23 AWG solid copper conductors.
    - 2) Individual conductors PVC jacketed.
  - b. Cable construction specifications:
    - 1) Core wrap - Polypropylene film.
    - 2) Shield - Corrugated aluminum tape bonded to riser-rated jacket.
    - 3) Cable Jacket marking: Must be legible and shall contain the following information:
      - 4) Manufacturer's name.
      - 5) Copper conductor gauge.
      - 6) Pair counts.
      - 7) UL and CSA listing.
      - 8) Manufacturer's trademark.
      - 9) Category rating.
      - 10) Sequential foot markings, in 1-foot increments.
      - 11) Cable jacket shall be gray with black lettering.
4. Horizontal distribution cable in conduit shall consist of four unshielded twisted pairs, #23 AWG, BerkTek Lanmark Cat. 6A type CMR or equal, with the following characteristics: Cable shall be characterized to 750 MHz and UL/ETL Listed by the Manufacturer printed on the cable jacket and package, as well as Intertek (ETL) Verified to TIA-568 Category 6A and ISO/IEC 11801 Class EA requirements for channel, link and component performance to support IEEE 10GBASE-T (802.3an) networks.
5. Horizontal distribution cable, where not installed in conduit in plenum spaces, shall be plenum rated and consist of four unshielded twisted pairs, #23 AWG, BerkTek Lanmark Cat. 6A type CMP or equal, with the following characteristics: Cable shall be characterized to 750 MHz and UL/ETL Listed by the Manufacturer printed on the cable jacket and package, as well as Intertek (ETL) Verified to TIA-568 Category 6A and ISO/IEC 11801 Class EA requirements for channel, link and component performance to support IEEE 10GBASE-T (802.3an) networks..
6. Horizontal cable shall meet the following requirements.



- a. Cable jacket marking: Must be legible and shall contain the following information:
    - 1) Manufacturer's name.
    - 2) Copper conductor gauge.
    - 3) Pair counts.
    - 4) UL and CSA listing.
    - 5) Manufacturer's trademark.
    - 6) Category rating.
    - 7) Sequential foot markings, in 2-foot increments.
  - b. Telecom station (and wireless antenna) cable jacket shall be blue with black lettering and shall be in 1000-foot boxes.
  - c. The jacket for telecom cabling serving AV devices and equipment shall be yellow with black lettering and shall be in 1000-foot boxes.
  - d. Type CMR cable shall be solid annealed copper with polyolefin insulation round design with flexible web separator with flame retardant PVC jacket.
  - e. Type CMP cable shall be same as Type CMR except with type FEP insulation.
  7. Data Equipment Inter-Connect patch Cords: Four twisted-pair stranded, Category 6A, 23 AWG copper conductors. Individual conductors PVC jacketed. Each conductor provided with unique color code. Manufacturer terminated on each end with Ortronics or Systimax Category 6A 8-pin / 8-position modular plug to be pinned as per EIA / TIA 568 C. Connector plug shall be polarized to prevent polarity reversal or split pairs, and shall be factory-marked to indicate top of connector. Inter-connect cord shall be UL listed.
  8. The Contractor shall complete data interconnects between patch panels and Owner-provided active network electronics.
  9. Lengths as required running from the data station cable terminations to the ports on equipment mounted in any rack position. Minimum length shall be 5 feet and the maximum length shall be 15 feet.
  10. Voice Cross-Connect Wire (for use on facilities where voice cables are terminated on blocks): One and Two twisted pair, 23 AWG solid copper conductors. Individual conductors PVC jacketed. One pair shall be yellow/blue color code and 2 twisted pairs shall be red/blue and red/orange coded. Must be UL listed for use as cross-connect wire. Provide one 1,000 foot reel of each type for use by Owner.
  11. Contractor to assist Owner to perform all voice cross-connects.
    - a. Minimum performance specifications:
      - 1) Cross-connect wire used on "voice" (telephone) cross-connects must meet the EIA/TIA 568 B impedance, attenuation and NEXT requirements for Category 3 horizontal cable.
- B. Fiber Optic Cables
1. The mechanical and environmental specifications for fiber optic cable shall be in accordance with ANSI/TIA-492.AAAC-B, Bellcore, FDDI, and NEC sections 770 standards. Optical fiber cables run shall be low-water-peak multimode or singlemode (OS2), and meet all of the requirements delineated within the specifications of ANSI/TIA-568.
    - a. Cable shall meet/exceed Bellcore TR-TSY-000020, FDDI and NEC sections 770-6(b) and (c) standards.
    - b. Strand counts shall be per drawings.
      - 1) Multimode inter-building (exterior) backbone fiber optic cable shall be outside plant rated, with number of multimode strands as noted on the drawings, with dielectric central member, non-armored, water-blocking material, ripcord, dielectric strength member over loose buffer tubes, and polyethylene jacket, Superior Essex TeraGain (11--6G01) Loose Tube Single Jacket All-Dielectric Cable or equal, and shall meet/exceed the following cable characteristics:

- (a) Multimode Core/Cladding size: 50/125um
  - (1) Maximum attenuation: 3.5 dB/km @ 850nm, 1.0 dB/km @ 1300 nm
  - (2) Minimum bandwidth: 200 MHz-km @ 850nm, 500 MHz @ 1300nm
- 2) Multimode indoor backbone fiber optic cable shall be plenum rated, with number of multimode strands as noted on the drawings, with dielectric central member, non-armored, ripcord, dielectric strength member over TB11 buffered fiber, PVC jacket, Superior Essex TeraGain (44---6G01) or equal, and shall meet/exceed the following the following cable characteristics:
  - (a) Multimode Core/Cladding size: 50/125um
    - (1) Maximum attenuation: 3.75 dB/km @ 850nm, 1.00 dB/km @ 1300nm
    - (2) Minimum bandwidth: 200 MHz-km @ 850 nm, 500 MHz-km @ 1300nm
- 3) Singlemode inter-building (exterior) backbone fiber optic cable shall be outside plant rated, with number of single mode strands as noted on the drawings, with dielectric central member, non-armored, water-blocking material, ripcord, dielectric strength member over loose buffer tubes, and polyethylene jacket, BerkTek, Superior Essex (11---9T01) Loose Tube Single Jacket All-Dielectric Cable or equal, and shall meet/exceed the following cable characteristics:
  - (a) Single mode Core / Cladding size: 8.31/125um
  - (b) Maximum attenuation: 0.40 dB/km @ 1310nm, 0.30 dB/km @ 1550nm
- 4) Singlemode indoor backbone fiber optic cable shall be plenum rated, with number of single mode strands as noted on the drawings, with dielectric central member, non-armored, ripcord, dielectric strength member over TB11 buffered fiber, PVC jacket, BerkTek, Superior Essex (44---9101) or equal, and shall meet/exceed the following cable characteristics:
  - (a) Single mode Core/Cladding size: 8.3/125um
  - (b) Maximum attenuation: 0.40 dB/km @ 1310nm, 0.30 dB/km @ 1550nm
- 5) Composite singlemode/multimode inter-building fiber optic cable shall be non-plenum rated, with number of single mode and multi-mode strands as noted on the drawings, with dielectric central member, non-armored, water-blocking material, ripcord, dielectric strength member over loose buffer tubes, and polyethylene jacket, Superior Essex TeraGain Loose Tube Single Jacket All-Dielectric Cable or equal, and shall meet/exceed the following cable characteristics:
  - (a) Multimode Core/Cladding size: 50/125um
  - (b) Multimode maximum attenuation: 3.5 dB/km @ 850 nm, 1.0 dB/km @ 1300nm
  - (c) Multimode maximum bandwidth: 200 MHz-km @ 850nm, 500 MHz-km @ 1300nm
- 6) All cable assemblies are to be Leviton Opt-X type or equal.
- 7) General Fiber Optic Cable Requirements:
  - (a) See the Drawings for required fiber counts and routing.
  - (b) ANSI.EIA/TIA-568.3-D.
  - (c) The cable manufacturer must guarantee the supplied single mode fiber optic cable will meet the specifications covering latest following standards and network applications using standard off-the-shelf, non-proprietary network hardware:
  - (d) OC-12 625 Mb/s
  - (e) OC-48 1024 Mb/s
  - (f) IEEE 1000 Base SX 1000 Mb/s
  - (g) ATM 625 Mb/s

- (h) ATM 1.2 Gbps
- (i) Fibre Channel 1.062 Gbps
- (j) Fiber optic cable sheath construction shall be of a tight-buffered MIC style design with integrated strength member.
- (k) The fiber optic cable shall have an integrated strength member, which is a high tensile strength dielectric providing axial strength and anti-buckling properties for the fibers.
- (l) The fiber optic cable shall utilize aramid yarn as a flexible strength member surrounding the buffered fibers beneath the cable jacket.
- (m) The individual fibers in a tight-buffered fiber optic cable shall be placed in groups of 6 or 12 fiber strands per subunit.
- (n) The individual subunits shall be color coded for easy identifications.
- (o) The cable tensile load rating shall be a maximum of 461 lbf for a 24-fiber count 6-fiber subunit.
- (p) The cable minimum bend radius at 0-150lbs pulling or handling load shall be 10 times the outside diameter of the sheath.
- (q) The cable minimum bend radius at 151-600 kbs pulling or handling load shall be 20 times the outside diameter of the sheath.
- (r) The fiber optic cable shall be low smoke, flame retardant and shall meet the flame test requirements of UL 910. It shall be UL listed as OFNP.
- (s) Multimode fiber optic connectors shall be duplex LC.
- (t) Fiber optic patch cables LC to LC shall be duplex with an oval over-sheath. Each fiber shall be labeled 'A' or 'B' to provide fast identification of "Transmit" and "Receive" fibers in patching between network electronics and backbone connections. Fiber optic duplex patch cables shall be provided in a 15 foot length as follows:
- (u) Avaya FL3EP-EP-15 or Leviton 5LDLC-M05.

C. Data Outlets

1. Cable termination hardware shall be individual; Category 6A rated Leviton (or equal) jacks. The listed product shall have the following characteristics:
  - a. One eight-position, eight-conductor jack (non-keyed), TIA/EIA-568-C Compliant, wired to T568B, Leviton category 6A.
  - b. The cover of the information outlet shall be labeled above the jack. The number on the outlet jacks shall coincide with the identification requirements listed in Part 3 of this Section below.
  - c. The color of all general use jacks shall be blue.
  - d. The color of all jacks at AV-related devices or racks shall be yellow.
  - e. The color of all faceplates and blank inserts or visible mounting plates shall match the adjacent power or signal outlet covers on the project (provided under another Section).
  - f. The devices at outlets and the devices in the patch panels shall be of the same manufacturer and same type.
  - g. See Drawings for number of jacks at each outlet, jack arrangement, and mounting type.
    - 1) The 8-pin 8-position jacks at terminal blocks and at each 4-pair termination shall be labeled with laser-printed polyester self-laminating wrap-around labels.
      - (a) Eight-pin 8-position jack label-faceplates;
        - (1) All labels shall be polyester and white in color;
        - (2) All labels shall be 1.80-inch in width and 0.375-inch in length;
        - (3) Labels shall have an adhesive backing;

- (4) Labels shall be attached to the faceplate by adhesive and clipping in behind the snap in clear plastic cover;
- (5) Labels shall be laser printed with the labeling scheme as specified;
- (6) Labels shall be Panduit Pan-CODE Laser Labels (PLL) part EFPL-1, Leviton LabelWare, or equal.
- (7) Terminal block designation strip:
- (8) All labels shall be polyester;
- (9) Labels shall be white in color for 4-pai data station cable terminations, located within a blue plastic label holder;
- (10) Labels shall be attached to the designation strip provided with the blue plastic holders;
- (11) All labels shall be 7.88 inches in width and 0.50 inches in length;
- (12) Labels shall have an adhesive backing;
- (13) Labels shall be laser-printed with the labeling scheme as specified;
- (14) Labels shall be Panduit Pan-CODE Laser Labels (PLL) part number PLL-22-Y3-1, Leviton LabelWare, or equal.
- (15) Labeling for all cable, jacks, and other elements of the telecom cabling system shall follow TIA/EIA-606 Standards. Provide color-coded labels for all wiring blocks as follows:
  - (16) Interface to Site Cabling - Brown
  - (17) Interface to Equipment Cabling - Purple
  - (18) Interface to Horizontal Cabling - Blue
  - (19) Interface to Telephone Company - Green

D. Termination Hardware at MDF /IDF's (Fiber Optic)

1. Optical Fiber Interconnect Equipment: Interconnect equipment shall be mounted on two or four post equipment racks as indicated on the drawings. Interconnect equipment shall be affixed to the rack by at least (4a) screws. The screws shall be the correct size and thread configuration for the holes in the rack. The screws shall be tightened to the extent that they hold the equipment firmly to the rack, without distorting the equipment or stripping the threads. All optical fiber interconnect devices shall be assembled and installed in accordance with the manufacturer's instructions and recommendations.
2. Fiber Interconnect Equipment shall be of sufficient size to permit termination of all fiber strands, maintaining minimum bend radius for both multimode and singlemode cables, and maintaining required cable storage. In the event that an enclosure must be oversized (number of termination ports) due to manufacturer's product standardization, the next larger available enclosure size shall be utilized.
3. Adapter plates, which accommodate Duplex LC type connectors, shall be provided within each Fiber Optic Distribution Panel (unless otherwise noted on the drawings). Multimode and Singlemode connectors (quantity and type as indicated on the drawings) shall be included on adapter plates.
  - a. The duplex LC adapter at the main distribution frame (MDF) shall be mounted in a B-A configuration.
  - b. The duplex LC adapter at each intermediate distribution frame (IDF) shall be mounted in an A-B configuration for cables coming from the MDF, and in a B-A configuration for cables going to an additional IDF (if applicable) further downstream.
    - 1) Fiber optic distribution panels shall be rack-mount type, utilizing Leviton Opt-X fiber System components, or equal, with fiber capacity as indicated on the drawings, equipped with snap-in adapter panels.
      - (a) Provide quantity of connector panels for complete termination of all fiber strands, complete with duplex LC adapters.

- (1) Provide blank connector plates for all spaces not equipped with adapter panels.
  - (2) All glass strands of each fiber optic cable shall be terminated on Leviton Fast Cure type duplex LC connectors which require no epoxy or heat cure devices, allow re-termination to reduce waste, and have the following characteristics:
    - (3) Ceramic ferrule
    - (4) 568LC style
    - (5) Plastic housing
    - (6) Low loss - 0.2 db (typical), 0.5 (guaranteed)
    - (7) All inter-building fiber optic cables (loose tube type) shall be terminated at fiber optic distribution panels using a Leviton 49887 Series (or equal) buffer tube fan-out kit.
    - (8) Labeling for fiber optic cabling and distribution panels shall match the labeling system for data cabling and hardware.
- E. Termination Hardware at MDF / IDF's (Data)
1. All cables installed for voice and data application shall be terminated in rack-mounted modular patch panels and the entire installation shall be in compliance with TIA/EIA-568-D Category 6A requirements.
  2. Patch panels shall be Leviton Category 6A discrete port-type. Port panels shall be certified by the manufacturer as suitable for 1000 Mbps data transmission. Patch panels shall be manufactured of aluminum or steel.
  3. Wire management hardware shall be Leviton Versi-Duct 49265 Series, or equal, installed at both the top and the bottom and between each patch panel and along the sides of the rack for patch cable routing and management.
  4. Wire managers shall be of sufficient width and depth to permit orderly routing of all patch cables at one hundred percent utilization.
  5. Patch panels shall be mounted on equipment racks. Panels shall be affixed to the rack by at least four (4) screws. The screws shall be of the correct size and thread configuration for the holes in the rack. They shall be tightened to the extent that they hold the equipment firmly to the rack, without distorting the equipment or stripping the threads.
  6. Patch panel quantity of ports as noted on the drawings.
- F. Equipment Racks
1. Floor mounted, two post or four post as indicated on the drawings, open bay relay type racks shall be utilized in equipment rooms to provide adequate mounting space for patch panels, wire managers, fiber optic distribution panels, and network integration equipment.
  2. Equipment racks shall be supported or braced at the top of each rack by a length of unistrut. Unistrut shall be attached to full height wall by the appropriate fastening hardware. Equipment racks shall have the following physical characteristics, unless otherwise noted:
  3. Equipment Racks shall be 7-feet X 19 inch 6061-T6 aluminum, bolt-down EIA standard equipment rack, with 1-1/4 X 1/2-inch front and rear flange hole pattern, 12-24 threaded holes, clear finish, and self-support base, UL listed. Each rack line up shall be equipped with a rack storage drawer.
    - a. Equipment cable guard, clear, Chatsworth 40058-519.
    - b. Seismic gussets for each rack, black, Chatsworth 11592-701.
    - c. Rack storage drawer, clear, Chatsworth 41050-519.
    - d. Rack storage drawer, clear, Chatsworth 11505-519.
    - e. Vertical plug strip, ivory, Wiremold, Plugmold 2400, V24GB606.
      - 1) Horizontal cable trough for equipment racks.

- (a) Patch cable organizers with 6.00 X 2.80-inch horizontal rings for routing patch cables across equipment racks to equipment ports. Panel shall fit in 2 rack units and match the color of the equipment racks, Chatsworth Products, clear. Chatsworth Products Large Horizontal Ring Panel 11564-519 or Leviton #49253-BCM.
  - (1) Vertical rack cabling sections:
  - (2) For use on the vertical edge rail of the equipment racks as indicated on Drawings.
  - (3) Seven-foot X 12.75-inch rectangular channel with latching cable retainers shall be Chatsworth Products Inc., Two-Sided Vertical Rack Cabling Section 11729-503, and color shall be the same as the equipment racks, clear finish.
  - (4) Provide (1) PDU per rack or wall cabinet. Unswitched, non-surge suppressed. 48" Vertical for floor-mounted racks and cabinets.
  - (5) Fiber patch cord management:
  - (6) For use in the vertical rack cabling section for the routing of fiber optic patch cables.
  - (7) Two-inch square, covered, yellow in color, slotted duct shall be 6 feet long, with cover. Duct shall be ADC FGS-MSHS-C.
  - (8) Fiber optic termination panel labels.
  - (9) Fiber optic termination panels shall be labeled using the plastic panel provided by the termination panel manufacturer. The plastic panel shall be overlaid with a one-piece adhesive backed-sheet. Contractor shall cut the sheet to size.
  - (10) Eight-and-a-half-inch x 11-inch laser printable adhesive backed sheets: Avery 5165.
- f. Communication Cabinets - Floor Mounted
  - 1) Floor mounted communication cabinets shall be utilized wherever communications equipment is located outside of dedicated voice/data or communication equipment rooms, or wherever noted on the drawings, to provide adequate mounting space for patch panels, wire managers, fiber optic distribution panels, and network integration equipment.
  - 2) A full height structure suitable for 19" mountings shall be provided in each communication cabinet. Communication cabinets shall have the following physical characteristics:
    - (a) 84" high, depth suitable for mounting of equipment up to 24" deep.
    - (b) Self-supporting, with levelers included.
    - (c) Cabinet shall be supplied with front and rear equipment mounting rails, drilled and tapped to a 5/8", 5/8", 1/2" hole pattern.
    - (d) Finish shall be black powder coat finish.
    - (e) Locking front Plexiglas door.
    - (f) Vented top and rear panel.
    - (g) Removable side Panels.
    - (h) 16 position outlet strip with circuit breaker and 12 foot cord.
      - (1) Floor mounted communication cabinet shall be ESW Pro-Series, or equal.
- g. Communication Cabinets - Wall Mounted
  - 1) Wall mounted communication cabinets shall be utilized wherever noted on the drawings, to provide adequate mounting space for patch panels, wire managers, fiber optic distribution panels, and network integration equipment.

- 2) Height of cabinet shall be as noted on the drawings. The cabinet shall be provided with 19" equipment mountings and shall have the following physical characteristics:
    - (a) Depth suitable for mounting of equipment up to 18 deep.
    - (b) Cabinet shall be supplied with front and rear equipment mounting rails, drilled and tapped to a 5/8", 5/8", 1/2" hole pattern.
    - (c) Finish shall be black powder coat finish.
    - (d) Locking front Plexiglas door.
    - (e) Vented top and bottom/back open for cable entry.
      - (1) Wall mounted communications cabinet shall be ESW W-00440 - Wall Box - Chasis Series or equal, minimum 24" deep, 24" wide and 36" high.
- G. Cable runway:
1. Cable runway: UL listed, tubular steel side rails, 1 1/2 - inch x 0.375-inch, with 1-1/2-inch stringers on 9-inch centers, 1-1/2-inch x 1-inch welded rungs, and tubular removable posts; yellow zinc dichromate (UZN) finish, complete with all required mounting hardware, fittings and cables needed to form a bonded (grounded) system.
    - a. Cable runway: Cablofil, B-Line SB Series, or equal, 15 inch wide, or as otherwise indicated on the Drawings.

### **PART 3 - EXECUTION**

#### **3.01 CABLE AND WIRE INSTALLATION:**

- A. This contractor shall be responsible for the provision and installation of all telecom cables including all supports, hangers, and hardware necessary for a complete installation. Under no circumstances shall cables be laid on the suspended ceiling. This contractor shall be responsible for providing and installing all necessary cable support hardware to meet Category 6A requirements. Refer also to Section 26 27 00 Basic Materials & Methods:
  1. T-Bar Suspended Ceilings: Copper station cabling may be run outside of conduits when routed above T-Bar suspended ceilings. Cables installed in this fashion are to be run horizontally in bundles and tied down neatly suspended from J-hooks, and well clear of any light fixtures or other electrical appliances that may affect data transmissions.
- B. At each telecom room cables are to be segregated by type, neatly tied together, properly dressed, and routed to the patch panels. All cables shall be tagged.
- C. Cable distances from patch panels to data outlet shall not exceed 295 feet. This contractor is responsible to ensure the distance specified is not exceeded.
- D. Care shall be exercised in routing both station and backbone/tie cables so as to avoid areas where sources of high levels of EMI (such as electric motors, transformers and fluorescent lighting fixtures) may exist. Maintain a minimum distance of 12" for voltages of 3KVA or less and 36" separation for voltage of 5KVA and more from these sources when run parallel. Cross at 90-degree angles where crossing must occur.
- E. Each station cable shall be "home run" (no splices or cross connection points) between jacks and patch panels or on fiber runs. Where fiber splices are required, splices shall be fusion type.
- F. All openings or raceway transitions through firewalls and floors shall utilize UL listed fire-rated penetrations.
- G. The fiber optical cable manufacturer's installation instructions shall be followed in order to avoid damage during placement within the facility. All fiber optic cable shall be placed within innerduct to provide mechanical protection and to provide visual warning or caution when handling or other work operations are performed adjacent to the installed fiber cable.

- H. No more than (2) 90-degree bends shall be allowed on all conduit runs for the horizontal voice/data cabling system, without an intermediate pullbox or junction box.
- I. Station cable terminations.
  - 1. Cable pair twists of Category 6A Cable shall be maintained within 0.5-inch of the point of termination. Under no circumstances shall cable pairs be untwisted or otherwise altered prior to termination.
  - 2. Do not bend Category 6A station cables to a radius of less than 4 times the cable diameter - approximately 2-inches.
  - 3. Allow slack in Category 6A cable bundles at entrances and exits of conduit sleeves and at transitions from "J" hooks to cable trays. Do not exceed maximum 25 pounds of pulling tension on cabling. Never pull cables tight at cable tray transitions; doing so may damage the cables by crimping them on the cable tray side of the bundles.
  - 4. Keep the cable evenly distributed within the cable tray. Do not allow the cables or bundles to be pulled tight against the splines or to be unevenly balanced on one side of the tray.
  - 5. Bundles of station cable in floor slots shall not exceed 2.5 inches in diameter, and shall be spaced 4 inches apart for proper fire stopping of the floor slot.
  - 6. Bundles of station cable in 4-inch floor sleeves shall not exceed a 39 percent fill.
- J. Fiber optic cable and termination installation.
  - 1. The Contractor shall place all optical fiber backbone cabling in accordance with these Specifications, and as indicated on the Drawings.
  - 2. Fiber optic cables: After dressing the cable to its final destination, sheath shall be removed to a point that allows the strands to be placed in break out kits to be splayed and terminated in a neat and uniform fashion. At this point all fibers shall be terminated in strict compliance with the manufacturer's submitted instructions.
    - a. Cable sheaths shall be clamped to the outside of fiber termination shelf. The cable clamp shall be manufactured by the manufacturer of the termination shelf and shall be designed to clamp outside plant fiber optic cable sheaths.
    - b. The tight-buffered sheath cable shall have the OFNR sheath and Kevlar strength members terminated at the cable clamp on the outside of the shelf. Only the buffer tubes and buffered fibers shall continue into the termination shelf.
    - c. Provide a minimum of 48-inches of subunit buffer tube and 40 inches of buffered fiber inside of the termination shelf.
- K. Where fiber or copper cable enters an equipment room, it shall be affixed to the backboard via "D" Rings and cable ties. All cable shall be neatly bundled, combed, and tied. All exposed cable runs shall be horizontal or vertical, and bends shall comply with manufacturer required minimum cable bending radii.
- L. All openings into wall mounted cabinets and fiber optic distribution panels shall have grommets for the protection of cabling.
- M. Fiber innerduct shall be installed in accordance with manufacturer's instructions and industry standards. Within the equipment rooms, the innerduct shall extend from the end of conduit to (4) feet above the floor and shall be affixed to the backboard by means of clamps designed for that purpose. Care shall be taken to avoid kinking the innerduct or applying excessive tension during the installation process.
  - 1. Innerduct runs do not have to be continuous throughout. Breaks are acceptable at pull boxes where required. This contractor is responsible for determination of actual lengths of innerduct required. This contractor is responsible for determination of actual lengths of innerduct required. Enough innerduct shall be provided and installed to extend from the fiber service loops at the MDF to the fiber service loops at each IDF. In pullboxes, segments of innerduct shall extend a minimum of (12) inches into the pullbox.



- N. During installation of optical fiber cable in conduit, special care shall be taken to avoid damage to the cable. While under pulling tension, the cable shall not be bent into a curve with a radius of less than (20) times the cable diameter. Pulling tension shall not exceed manufacturer's recommended maximum tensile load. Contractor shall utilize a winch with tension control or a "break-away" link designed to break away at or below the recommended maximum tension.
- O. A minimum (30) foot service loop shall be provided at each terminal location for all fiber optic cables. Provide service loop via backboard attached cable reels.
- P. Each end of gel-filled voice cable shall be dammed at the breakout point-using manufacturer recommended blocking kit. All pairs extending beyond the breakout point and dam shall be cleaned such that no gel remains.
- Q. Provide (1) patch cable for each activated jack on the project. Lengths shall be 5ft. minimum or as required for the MDF or IDF design. Patch cords shall be factory tested to ensure compliance with current standards.
- R. Provide one fiber jumper for each two strands of fiber at each equipment rack, with duplex LC type connectors unless otherwise noted on the drawings.
- S. Equipment racks and Frames.
  - 1. Equipment racks shall be assembled and mounted in locations noted on the drawings and as described herein. Each rack shall be assembled in accordance with the manufacturer's instructions and recommendations. Each rack shall be mounted such that the side rails are plumb. Each rack shall be affixed to the building structure at each of the mounting holes provided. Attachment shall be by 1/2" X 1-1/4" lag bolts. A 3/8" pilot hole shall be drilled for each lag bolt. Each bolt shall be tightened to the extent that it holds the mounting hardware firmly, but not so tight as to distort the hardware or strip the threads
  - 2. Provide seismic support and bracing for all equipment racks installed under this work. Equipment racks must be structurally designed to accommodate cable loads. No other support mechanism will be supplied. Comply with Division 1 of these Specifications. Provide seismic design calculations and seismic design drawings prepared by the contractor's structural engineer for coordination and approval by Owner's Representative prior to fabricating or installing any supports. In general, provide support only from floor slabs, beams, columns, or structural walls, (such as shear walls). Do NOT use existing or new partitions to provide either vertical or lateral support UNLESS the seismic design calculations and drawings demonstrate that the partition, either with or without reinforcement, is able to support the seismic and other loads. Any proposed reinforcement to be the responsibility of the Contractor.
  - 3. Relay racks:
    - a. Assemble equipment racks with cable management hardware specified.
    - b. Fasten the equipment racks to the steel wire cable tray or cable ladder with equipment rack brackets.
    - c. Place a base dust cover panel over the area between the front and rear base flange of each equipment rack.
    - d. Place horizontal ring style cable managers in the racks at the positions shown on the drawings. Relocate the cable managers within the racks as required to accommodate the installation of network electronics and to manage the copper and fiber patch cables installed for use with this system.
    - e. Horizontal cable troughs for managing patch cables routing to equipment ports shall be placed on equipment racks.
      - 1) Six horizontal ring panels shall be placed in 7-foot equipment racks.
      - 2) Six Philips head screws, threaded to the 12-24 threading of the equipment racks shall be used to attach each horizontal trough.

- (a) A vertical rack cabling section shall be placed on each of the 2 vertical edge rails of the equipment racks. Attach the 2-sided vertical rack cabling section to the equipment racks at the location of the threaded inserts. The 2-sided vertical rack cabling section shall be bolted to the threaded inserts in the side rails of the each equipment rack with four 1/2 -inch hex head bolts and lock washers.
- T. Labeling: Labeling shall include, but not be limited to:
1. Labeling telecommunications outlet faceplates;
  2. Labeling station cables;
  3. Labeling terminal blocks;
  4. Labeling fiber optic cable sheaths;
  5. Labeling fiber optic and copper splice closures;
  6. Labeling fiber optic stands;
  7. Labeling fiber termination panels;
  8. Labeling of telecommunications equipment racks and fiber frames;
  9. Labeling of telecommunications pathways, including conduits, steel wire cable trays, cable runway and pullboxes;
  10. Labeling of all grounding conductors and ground bars in the Intermediate Distribution Facilities (IDFs) and Main Distribution Frame (MDF).
  11. The intent of the final labeling is to allow the Owner or persons contracted by the Owner to identify any part of the structured cabling system through physical identification of the components and their related components at the specified access point without the use of electrical, electronic or mechanical means of identification.
  12. Equipment rack and cable tray / pullbox labels:
    - a. Equipment Racks shall be clearly labeled as follows:
      - 1) Labels shall be adhesive backed individual letters and numbers.
      - 2) Individual letters shall be 3/4\*-inch in width and 1-inch in height.
      - 3) Individual characters shall be self-spacing by simply butting the individual characters against each other in a row.
      - 4) Characters shall be either white or yellow on a black background.
      - 5) Labels shall be designed for exposed outdoor applications.
      - 6) Labels shall be:
        - (a) 3M Scotchcal 5003 Non-Reflective Lettering Systems.
        - (b) Panduit, PVL100YB.
        - (c) Or equal.
      - (1) Cable Tray Labeling:
      - (2) Cable tray shall be provided with a label clip fastened to the underside.
      - (3) Label clip shall be 3.94-inches wide by 0.63-inch high and shall attach to the cable tray without the use of additional fasteners;
      - (4) Label clips shall be attached to each label clip;
      - (5) All labels shall be polyester with white color;
      - (6) All labels shall be at least 3.00 inches in width and 0.38-inch in length;
      - (7) Labels shall have an adhesive backing;
      - (8) Labels shall be attached to label clips with the adhesive back self-laminating portion;
      - (9) Labels shall be laser printed with the labeling scheme as specified;
      - (10) Label shall be 0.25-inch high, Ariel San Serif;
      - (11) Labels shall be Panduit, Pan-CODE Laser Labels (PLL) part number PLL-19-Y2, or equal.

- (12) Labeling at Pull Box:
- (13) Cover and interior labeling for pull box:
- (14) All labels shall be polyester with white color;
- (15) All labels shall be at least 1.88- inches in width and 0.83-inch in length;
- (16) Labels shall have an adhesive backing;
- (17) Labels shall be attached on cover and interior of pullbox at locations indicated on the Drawings with the adhesive back self-laminating portion.
- (18) Labels shall be laser printed with a labeling scheme approved by the Owner's Representative.
- (19) Label shall be 0.25-inch high, Ariel San Serif;
- (20) Labels shall be Panduit, Pan-CODE Laser Labels (PLL) part number PLL-19-Y2, or equal.
- (21) Cover and interior labeling for conduit at pull box:
- (22) All labels shall be polyester with white color.
- (23) All labels shall be at least 1.88- inches in width and 0.83-inch in length;
- (24) Labels shall have an adhesive backing;
- (25) Labels shall be attached on cover and interior of pullbox with the adhesive back self-laminating portion at location where conduit enters the pullbox.
- (26) Labels shall be laser printed with a labeling scheme approved by the Owner's Representative.
- (27) Copper station - cable sheath labels:
- (28) Copper station cable sheaths at 8-pin 8-position jacks, at junction boxes, enclosures, and pull boxes shall be labeled with laser-printed polyester self-laminating wrap-around labels.
- (29) All labels shall be polyester with white color.
- (30) All labels shall be at least 1.00- inches in width and 1.33-inch in length; with a 0.5-inch x 1-inch printable area;
- (31) Labels shall have an adhesive backing;
- (32) Labels shall be attaché to cable sheaths by wrapping around the sheath with the adhesive back self-laminating portion;
- (33) Labels shall be laser printed with the labeling scheme as specified;
- (34) Cable / outlet / jack / termination identification:
- (35) Each copper cable, its associated jack at the outlet, and the associated C-4 connecting block on the terminal block or patch panel shall be labeled with a unique identifier consisting of the following:
- (36) The IDF room number where the station cable is terminated, ###.
- (37) The end user room number in which the 4-pair cable is terminated and the telecommunications outlet is located, ###.
- (38) A 3-digit serial number, rest to 001 for each room, which sequentially identifies each telecommunications jack / cable in a room, ###.
- (39) The type of service provided by a Particular cable, either D for data or V for voice.
- (40) Example of IDF 107, user room 129, jack / cable number 1 (data cable): 107-129-001-D.
- (41) The following are examples of the numbering scheme:
- (42) IDF room 1.1, User Rm. 111, Jack/ cable 1, Data line.
- (43) 1.1-111-001-D
- (44) IDF Number: 1.1
- (45) Room Number: 111

- (46) Serial Number: 001
- (47) Data Line: D
- (48) IDF room 1.1, User Rm. 106, Jack / cable, Voice line.
- (49) 1.1-106-001-V
- (50) IDF Number: 1.1
- (51) Room Number: 106
- (52) Serial Number: 001
- (53) Voice Line: V
- (54) Cable identification:
- (55) Each fiber optic backbone cable sheath shall be labeled with a unique identifier as shown on the Drawings.
- (56) Label the cable sheath at the termination shelf and on the innerduct as the fiber optic cables pass through IDFs and pull boxes.
- (57) Each LC connector in each termination shelf shall be labeled with a unique identifier as noted on the Drawings.
- (58) Cable sheath identification:
- (59) Identify multi-pair copper riser cable sheaths with machine-generated labels at the following locations:
- (60) Within 12 inches of the point that the cable exits the top or bottom of the 110P-type terminal block column.
- (61) Within 12 inches of the point that the cable enters a splice.
- (62) At 40-foot intervals above T-Bar ceilings.
- (63) At pull boxes
- (64) Within 12 inches of the point that the cable enters or exits wall and floor sleeves.
- (65) Warning Tags: At each location where fiber cable is exposed, it shall be marked with warning tags. These tags shall be yellow or orange in color, and shall contain the warning: "CAUTION FIBER OPTIC CABLE". The text shall be permanent, black, block characters, and at least 3/16 high. A warning tag shall be permanently affixed to each exposed cable or bundle of cables, at intervals of not more than (5) feet. Any section of exposed cable, which is less than five (5) feet in length, shall have at least one warning tag affixed to it.

### 3.02 GROUNDING SYSTEM AND CONDUCTORS

#### A. Bonding and Grounding:

1. Communication bonding and grounding shall be in accordance with the NEC and NFPA. Guidelines of ANSI/TIA-607-C shall be followed. Horizontal cables shall be grounded in compliance with ANSI/NFPA 70 and local requirements and practices. Horizontal equipment includes cross connect frames, patch panels and racks, active telecommunication equipment and test apparatus and equipment.

#### B. Telecommunications Bonding Backbone:

1. Provide a Telecommunications Bonding Backbone utilizing a minimum #6 AWG bonding conductor (or as shown on drawings) that provides direct bonding between equipment rooms and telecommunications closets. Connect this bonding backbone cable to the main grounding electrode system at the electric service switchboard.
2. Provide a copper ground bar at each telecommunications equipment room or rack location, connected to the bonding backbone.
3. Provide a #6 AWG stranded copper cable from each ground bar to each adjacent rack or cable trays system.

### 3.03 LIGHTNING PROTECTION BLOCKS

- A. Protection:
  - 1. Provide protection blocks at each building entry for copper site cable terminations; as manufactured by Circa, or equal.
  - 2. Provide sufficient capacity for protections of all pairs.
  - 3. Materials: As indicated on the Drawings.

### 3.04 FIRE AND SMOKE PARTITION PENETRATIONS

- A. Conduit sleeves shall be provided as part of this contract as a means of routing cables through fire-rated walls and floors. Openings in sleeves and conduits used for system cables and those that remain (empty) spare shall be sealed with an approved fireproof, removable sagging material at completion. Sleeves, which pass vertically from floor to floor, shall be sealed in a similar manner using an approved re-enterable system. Additional penetrations through rated assemblies, necessary for passage of voice/data wiring, shall be made using an approved method and permanently sealed after installation of cables. UL systems must be available for each firestop penetration and included in the submittal. All firestop products must be readily available at local electrical and/or telecom distribution outlets.

### 3.05 PLYWOOD BACKBOARDS

- A. Provide backboards shall be fire retardant, 3/4-inch A-B grade plywood, void free, 2440-mm (8 feet) high unless otherwise noted, capable of supporting attached equipment, and painted with a minimum of 2 coats of fire retardant off-white semi gloss paint. Manufacturer's stamps visible from the front side of the plywood backboard shall be masked to painting.
- B. Plywood backboards shall be fastened to the structural members of the building only using an approved fastener. Plywood backboards shall not be anchored to GBW.
- C. Plywood shall be mounted from +6-inches AFF to +8 feet 6-inches at the locations indicated on the Drawings.
- D. Plywood backboards shall be cut to fit in width and shall have holes cut into the backboard to accommodate and provide access to devices behind the backboard, such as switches and outlets.

### 3.06 FIBER CABLE TESTING AND DOCUMENTATION

- A. Fiber Optic Cable Test Equipment:
  - 1. Cable tester shall be NRTL certified for compliance to be used as an Optical Loss Test Set.
  - 2. Cable testers shall be Optical Power Meter and High Resolution Optical Time Domain Reflectometer (OTDR). The cable tester shall be NRTL certified for compliance to latest TIA/EIA performance requirements at 850, 1300, 1310 and 1550 nm.
  - 3. Testers shall have been calibrated at least one year prior to use on this project. Calibration must be in accordance to IEC 61315 and IEC 61746 respectively. Contractor to provide proof to Owner if requested.
  - 4. All testing equipment (OTDR, Light Loss, Splicer etc.) shall be owned by the Contractor. Contractor must prove ownership of equipment if requested
    - a. Cable segments and links shall be tested from both ends of the cable for each of the construction phases. (Verify that cable labeling matches at both ends).
      - 1) The system will not be considered certified until the tester has certified to the Owner that the performance of the physical layer of the system has been fully tested and is operational at the completion of the installation phase.
      - 2) Testing Procedures:
        - (a) Perform each visual and mechanical inspection and electrical test, including optional procedures, stated in NETA ATS, Section 7. Certify compliance with test parameters and manufacturer's written recommendations. Test

- optical performance with optical power meter capable of generating light at all appropriate wavelengths.
- (b) Prior to testing, all connectors shall be properly cleaned with an approved product manufactured specifically for this purpose.
  - (c) Prior to beginning testing, confirm that all testing equipment is fully charged or operating on building power. If the test equipment power levels drop below 50%, recharge unit or continue testing with a different (fully charged) tester.
  - (d) All testing shall comply with latest standards, requirements, and procedures of ANSI/TIA/EIA. Tests shall be conducted using ANSI/TIA-526-14A, Method B. Test results evaluation for the panel to panel (backbone) shall be based on the values set forth in ANSI/TIA-568.
  - (e) Initially test optical cable with a light source and power meter utilizing latest Tier 1 procedures as stated in TIA/TSB-140.
  - (f) Measured results shall be plus/minus 1 dB of submitted loss budget calculations. If loss figures are outside this range, test cable with Optical Time Domain Reflectometer (OTDR) to determine cause of variation. Correct improper splices and replace damaged cables at no charge to the Owner.
- 3) Fiber Optic Cables:
- (a) Shall be tested bi-directionally for length and attenuation at both the short and long wavelengths as specified in TIA TSB-140.
  - (b) Single-mode fibers shall be dual wave length and provide attenuated wavelength of the 1310 nm and 1550 nm. 850 nm for single-mode fiber shall not be acceptable under any circumstances. Multimode shall be tested at 850nm and 1300nm.
  - (c) After installation of connectors, visually inspect each fiber end-face at 10X magnification. Refinish fibers with visible defects and / or striations in the core area.
  - (d) Demonstrate that measured link loss does not exceed the “worst case” allowable loss, defined as the sum of the connector losses (based on number of mated connector pairs at the EIA / TIA 568 maximum allowable loss of 1.5dB per mated pair), the optical fiber loss (based on length) and the EIA / TIA 568 maximum allowable loss (3.75dB/km @ 850nm and 1.0dB/km @ 1300nm).
  - (e) Strands whose measured attenuation fall outside the acceptable range shall be subject to further inspection and testing to determine the nature of the fault. At a minimum, an OTDR shall be used to determine the true loss for each connector pair, the exact length of the fiber and to identify the presence of any core damage.
  - (f) Faults related to connectorization shall be corrected, and the fiber re-tested, until acceptable attenuation measurements are recorded.
  - (g) Where defects are found to be inherent in the fiber itself, replace any cable having fewer than the manufacturer’s guaranteed number of serviceable fibers.
  - (h) All fiber optic test instruments used on the site shall be capable of storing test data files and downloading these test results as data files. The fiber optic strand number shall be used as the record identifier for each test.
  - (i) All OTDR traces shall be delivered to the Owner’s Representative in electronic format. The Contractor shall provide the Owner’s Representative with software to read the OTDR traces. The application software shall be licensed to the Owner.

- (j) All Power meter readings shall be provided in a file format capable of being inserted into a Microsoft Excel spreadsheet for review. Power meter readings shall be delivered to the Owner's Representative in electronic format.
- 4) All cables shall be tested after termination using a cable certification tester that contains the test equipment manufacturer's most current version of firmware.
- 5) Upon completion of testing, all connectors shall be capped with a product made for that specific function by the connecting hardware manufacturer to prevent the contamination of the fiber from construction debris or other foreign objects.
- 6) Test Results:
  - (a) The test results information for each link shall be recorded in the memory of the field tester upon completion of the test. The tester shall be capable of storing test data in either internal or external memory. The external media used shall be left to the discretion of the user.
  - (b) Test results saved by the tester shall be transferred into a Windows based database utility that allows for maintenance, inspection and archiving of these test records. A guarantee must be made that the measurement results are transferred to the PC unaltered as well as any printed reports generated from the software application.
  - (c) The test results information for each link shall be recorded in the memory of the field tester upon completion of the test. The tester shall be capable of storing test data in either internal or external memory. The external media used shall be left to the discretion of the user.
  - (d) Test results saved by the tester shall be transferred into a Windows based database utility that allows for maintenance, inspection and archiving of these test records. A guarantee must be made that the measurement results are transferred to the PC unaltered as well as any printed reports generated from the software application.
  - (e) Optional formats of data reporting are: comma separated variable (.csv), Portable Document File (.pdf) or compatible, plain text (.txt), or hypertext markup language (.html/.htm).
  - (f) Test results shall include the following:
    - (1) Telecommunications Room number
    - (2) Location of fiber pull i.e. (Equipment Room # to Telecom Room #)
    - (3) Patch panel # and location
    - (4) Connector type
    - (5) Distance
    - (6) Wavelength tested
    - (7) Technician who performed the testing
- 7) The Owner and Architect reserve the right to observe testing and/or randomly sample completed links for conformance to project specifications.

### **3.07 COPPER CABLE TESTING AND DOCUMENTATION**

- A. Cabling systems shall meet or exceed the electrical and transmission characteristics of the systems specified.
- B. Cable segments and links shall be tested from both ends of the cable for each of the construction phases. (Verify that cable labeling matches at both ends).
- C. The system shall not be considered certified until the tester has acknowledged that the performance of the physical layer of the system has been fully tested and is operational at the completion of the installation phase.

- D. After the installation is complete, in addition to any other required testing as described herein, and at such times as the Owner or Architect directs, the Contractor shall be present while the Owner conducts an operating test for approval. The installation shall be demonstrated to be in accordance with the requirements of this specification. Any defects revealed shall be corrected promptly at the Contractor's expense and the tests performed again.
- E. After review of the completed test results, the Owner reserves the right to retest the installed cables, utilizing the Contractor's tester and the Contractor's labor.
- F. Equipment Manufacturer's Factory Test
  - 1. Each cable and equipment manufacturer shall factory test their respective products being installed on this project and provide test reports at time of delivery. Provide separate respective test reports indicating that they meet or exceed the latest applicable TIA/EIA Standards and technical bulletins.
  - 2. All other products relative to this specification shall be tested to its respective industry strictest standards.
  - 3. Each manufacturer shall factory test their respective cable or equipment provided to this project at several lower frequency levels, including the minimum and maximum frequency level indicated herein. The test reports shall indicate test results for at least five equal incremental frequency levels including the maximum required.
    - a. Field Testing Equipment: Submit during shop drawing review on the testing equipment to be utilized on this project. Tester shall be a Level IV device or better and configured to the specific cable installed. The installer shall test all cables installed under this Section.
      - 1) Unshielded Twisted Pair Testing Equipment:
        - (a) The cable tester shall have a wide variety of preprogrammed cable types as an integral part of its testing system and have the ability to test cables less than 6 feet (6ft.) from the test point.
          - (1) Testing shall be accomplished using level III or higher field tester that is loaded with the most current version of test software by the manufacturer of the test equipment.
          - (2) Provide factory calibration report of field test equipment.
      - 2) Testing Procedures:
        - (a) Testing shall conform to TIA-568 standards.
        - (b) Testing shall be to the Permanent Link Test Parameters.
        - (c) Test each pair and shield of each cable for opens, shorts, grounds, and pair reversal. Correct grounded and reversed pairs. Examine open and shorted pairs to determine if problem is caused by improper termination. If termination is proper, tag bad pairs at both ends and note on termination sheets.
        - (d) Test each UTP cable and passive components. Provide certification that entire installation of UTP cabling, equipment and jacks are NRTL certified meeting or exceeding a minimum of category performance specified on all four pairs of conductors.
        - (e) Tests shall be based on each pair of conductors and not the aggregate multiple pair results.
        - (f) Test all installed cable segments end-to-end, from the telecommunications room horizontal patch panel/cross connect block panel to each work area outlet and from each telecommunications room backbone patch panel/cross-connect block panel to respective main cross connect, and from the work area outlet to the main cross-connect (through patch cables or cross- connect wiring) with a Signal Injector, Graphical Link Testing Meter and Time Domain Reflectometer (TDR) for compliance to latest TIA



- performance requirements, as well as NEXT, ELFEXT, structural return loss, alternating power sum, opens, shorts, continuity, cable length, and characteristic impedance.
- (g) Provide report indicating failures and what actions were taken to ensure a passing horizontal cable and its terminations. Any cable failing the certification test (Fail, Fail\* or, Pass\*) must have remedial work done to provide a full pass test result; Remediation may include re-termination or replacement of the cable, which fails. Cables passing within tolerance only (Conditional Pass\*) will not be accepted.
- 3) Test results:
- (a) The test results information for each link shall be recorded in the memory of the field tester upon completion of the test. The tester shall be capable of storing test data in either internal or external memory. The external media used shall be left to the discretion of the user.
  - (b) Test results saved by the tester shall be transferred into a Windows based database utility that allows for maintenance, inspection and archiving of these test records. A guarantee must be made that the measurement results are transferred to the PC unaltered as well as any printed reports generated from the software application.
  - (c) Optional formats of data reporting are: comma separated variable (.csv), Portable Document File (.pdf) or compatible, plain text (.txt), or hypertext markup language (.html/.htm).
  - (d) Test Results shall include the following:
    - (1) Applicable room number of jack location (room number per Contract Documents)
    - (2) Applicable Telecommunications Room number
    - (3) Circuit I.D. number with corresponding jack identifier
    - (4) Wire Map - shall include the following:
      - (5) Continuity to the remote end
      - (6) Shorts between any two or more conductors
      - (7) Crossed pairs
      - (8) Reversed pairs
      - (9) Split pairs
      - (10) Any other mis-wiring
      - (11) Length
      - (12) Insertion Loss
      - (13) Near-end Crosstalk (NEXT) Loss
      - (14) PS-NEXT (Power Sum Near End Cross Talk)
      - (15) ELFEXT (Equal Level Far End Cross Talk)
      - (16) PS-ELFEXT (Power Sum Equal Level Far End Cross Talk)
      - (17) Propagation Delay
      - (18) Delay Skew
      - (19) Return loss

### 3.08 TRAINING AND PATCHING

- A. The Contractor shall provide a minimum of (1) person for a minimum of (8) man-hours beginning with the first scheduled move-in date to train Owner personnel in maintenance and repair of cabling system. This technician shall also assist the Owner in patching telecom services throughout the facility during the move-in period. It is at this time that all Owner-provided connectivity for voice and data services will be provided to the Contractor. Patching of the station assignments between the Owner's services demark shall also be considered part of this Contractor's work.

### 3.09 ACCEPTANCE

- A. Prior to acceptance all the following conditions must be met:
1. As required the Contractor shall make submittals and deficiencies or rejected submittals shall be corrected.
  2. All specified cable management devices including cable ladder, steel wire cable tray, 2-sided vertical rack cabling sections, horizontal ring panels, and fiber optic troughs shall be installed as indicated and specified. All parts not installed shall be inventoried and provided to the Owner in the manufacturer's packaging.
  3. All seismic bracing shall be in place.
  4. All specified station cabling with associated termination components, labeling and fire stopping shall be installed properly. Any component not installed shall be inventoried and provided to the Owner in the manufacturer's packaging; loose miscellaneous parts shall not be accepted.
  5. Terminal blocks shall be clean and free of trimmed or cut-off copper pairs, sheaths, armors, cable lubricants or any other disposables used in the installation of the station cables.
  6. All station cables shall be neatly dressed behind the terminal blocks in the IDF.
  7. The backbone fiber optic cable system including all strands, connectors, termination shelves, fiber optic distribution panels, and fiber optic storage shelves has been installed and tested per these Specifications.
  8. Do not install fiber optic cross-connects until after the backbone distribution cable test reports have been reviewed and accepted by the Owner.
  9. All required submittals indicated in this Specification Section shall be made by the Contractor, and any deficiencies or rejected submittals shall be corrected.
  10. All specified fiber optic backbone cabling with associated termination components, splicing, labeling and testing shall be installed and completed properly. Any component not installed shall be inventoried and provided to the Owner in the manufacturer's packaging. Loose miscellaneous parts shall not be accepted.
  11. The fiber optic termination shelves and the racks and floors around the shelves, shall be clean and free of trimmed or cut-off fiber optic strands, buffering, sheath and cable lubricants and any other disposables used in the placement and termination of the fiber optic backbone cables.
  12. All innerducts and fiber optic backbone cables shall be neatly dressed into the pathways, communications vaults and vault racking.
  13. Any deficiencies and punch list items shall be corrected.
  14. All as-built documentation shall be complete, reviewed and provided to the Owner.
- B. Acceptance of the telecommunications system by the Owner shall be based on the result of testing, functionality, and the receipt of documentation and warranty. With regard to testing, Contractor shall provide two technicians, equipped with the specified test equipment, to do random test verification in the presence of, and at the direction of, an Owner designated representative. Verification testing shall not exceed 20% of the cable plant, provided cables tested are verified to be 100% compliant, per requirements previously stated. If more than 5% of cables tested during the verification process fail, Owner reserves the right to have the entire cable plant retested, at the Contractor's expense, and in the presence of an Owner-designated representative.

### 3.10 RECORD DRAWINGS

- A. The project record drawings shall show the types, locations and counts of installed:
1. Fiber optic cables and strands;
  2. Fiber optic terminations counts and types.

- B. The project record drawings shall show the types, locations, cable numbers and pair counts of installed twisted-pair cable:
  - 1. Cable routing and numbers.
- C. The project record drawings shall show the types and locations of installed equipment racks.

**END OF SECTION**

**SECTION 27 5103**  
**ASSISTED LISTENING SYSTEM**

**PART 1 - GENERAL**

**1.01 WORK INCLUDED**

- A. All materials, labor, equipment, and incidentals necessary to install an FCC-compliant, ADA-compliant, FM-based, Stationary Assisted Listening System for wireless transmission of sound in the areas noted on the plans and as specified herein.
- B. Provide a complete Assisted Listening System (ALS), including transmitter, receiver, headsets, and chargers for the locations indicated on the drawings and/or indicated by the Architect. Equipment for one example system is specified herein.
- C. Any associated electrical work as might reasonably be implied as required, even though not specifically mentioned herein or shown on the drawings.
- D. It is the intent of the drawings and specifications that systems be complete and be ready for operation.
- E. Provide CBC 2019 compliant seismic installation. See Section 26 05 00 for all certification and submittal requirements.

**1.02 SUBMITTALS**

- A. Comply with the requirements of Section 26 05 00.
- B. Provide submittals for the following equipment:
  - 1. Transmitter
  - 2. Receivers
  - 3. Charger
  - 4. Headsets
- C. Equipment Manual: Furnish with the submittal, and with each unit delivered, an equipment manual that details the installation, operation and maintenance instructions for the provided equipment. Provide minimum (3) copies.
- D. Spare Parts: Provide a list of customer-replaceable spare parts in the submittal. All spare parts shall be quickly and easily field-replaceable.

**PART 2 - PRODUCTS**

**2.01 REQUIREMENTS**

- A. The ALS shall be capable of broadcasting on 57 channels and be frequency agile.
- B. The ALS system shall have 80dB SNR or greater, end-to-end. Receivers shall be frequency agile and frequency set with a "seek" button.
- C. The receiver shall incorporate a stereo headset jack that allows the user to plug in either a mono or stereo headset and listen to audio normally.
- D. The portable receivers and transmitters shall incorporate automatic battery charging circuitry for recharging of Ni-MH batteries.

**2.02 ACCEPTABLE MANUFACTURERS**

- A. List of Equipment Manufacturers:
  - 1. Listen Technologies, or equal. All catalog numbers referenced in this specification are by Listen Technologies, unless otherwise noted.

**2.03 PRODUCTS**

- A. Provide (1) transmitter base station with line level audio inputs. The transmitter shall have an easy-to-read front panel display to indicate output levels, channels, and related settings, and shall have push-button controls.

1. Provide compatible audio cable for interconnection with A/V system.
2. Catalog number: LT-800-072
- B. Provide (1) rack mount kit with plexi-glass security cover.
  1. Catalog number: LA-326
- C. Provide (1) universal antenna for mounting on ceiling, wall, remote base, or flexible dipole. If antenna is removed, provide and install RG58 co-axial cable in 1" conduit for less than 100ft or RG8 co-axial cable in 1" conduit for more than 100ft runs (50 Ohm).
  1. Catalog number: LA-122
- D. Provide portable FM receiver units equal to 4% of the seating capacity plus (1), minimum of (3) units per system.
  1. Each receiver shall have the following characteristics:
    - a. Capable of being clipped to a pocket or belt.
    - b. Include an on/off switch and volume control to adjust the output level as required by the listener.
    - c. Easy-to-read channel label on the front face.
    - d. Battery operated.
    - e. Designed to allow battery recharging without removal from the receiver. Batteries shall be capable of being recharged with the charger/organizer.
  2. Catalog number: LR-400-072
- E. Provide quantity of ear and neckloops equal to the number of receivers provided - 75% ear speakers, 25% neckloops.
  1. Catalog number: LA-164 ear speaker.
  2. Catalog number: LA-166 neckloop.
- F. Provide charger device / storage container(s) to accommodate all of the provided equipment.
  1. Catalog number: LA-321 (8 unit model)
- G. Provide Ni-MH rechargeable batteries.
  1. Catalog number: LA-362
- H. Provide ADA Access/Compliance signage kit and coordinate placement with architect.
  1. LA-304

### **PART 3 - EXECUTION**

#### **3.01 GENERAL**

- A. Refer to Section 26 05 00 for details of work under this section.

#### **3.02 INSTALLATION**

- A. Locate transmitter adjacent to an available audio system input.
- B. Audio input shall be taken from the audio system (provided in another section of work) via a standard line level stereo audio signal. Connect complete for full operation.

#### **3.03 SYSTEM STARTUP**

- A. The Manufacturer shall provide a factory authorized technician to commission and confirm proper installation and operation of all system components.

#### **3.04 TRAINING**

- A. Manufacturer shall provide factory authorized application engineer to train Owner personnel in the operation and programming of the Assisted Listening System. Provide (2) hours on-site training.

#### **3.05 TESTING**

- A. Test for a complete and operational system after commissioning of ALS System.

- B. Test each receiver at each selectable frequency, and at all probable usage locations within the area of intended use.

**END OF SECTION**

**SECTION 28 3100**  
**FIRE ALARM SYSTEM WITH VOICE EVACUATION**

**PART 1 - GENERAL**

**1.01 DESCRIPTION**

- A. This project shall include the furnishing, installation, connection, programming, commissioning, and testing of new fire alarm equipment required to form a complete coordinated system ready for operation at the campus. Equipment shall be networked as indicated on the drawings. The fire alarm system shall include, but not be limited to, alarm initiating devices, alarm notification appliances, voice evacuation system, control panel (with multiple panels at different buildings networked together where indicated on the drawings, auxiliary control devices, annunciators at each building, power supply extender panels (as required), amplifiers, and all associated wiring (fiber optic network and copper system cabling).
- B. The system shall generally consist of a standalone fire alarm control panel with power supply extender panels and amplifiers at each building, or if indicated on the drawings a networked system with fire alarm control panels at each building, to control and operate all initiation and notification appliances at each building. The standalone fire alarm control panel shall include a digital dialer with off-site monitoring connection in order to identify the specific location of the control panel to the Fire Department. If a networked system is indicated on the drawings, each fire alarm control panel shall be identified for the specific building it controls and shall include a digital dialer with off-site monitoring connection in order to identify the specific building to the Fire Department. All panels at the facility shall be networked together in order to allow the central main fire alarm control panel (main FACP) to monitor each building on the site. Each building shall include a local LCD style annunciator. .
- C. Alarms/troubles at each building shall activate the local notification devices (or report troubles) at the respective building panel only and report the alarms/troubles to the main fire alarm control panel, but shall not activate other building notification devices.
- D. The system shall include an emergency voice evacuation alarm communication system. A digitized pre-recorded voice message shall notify occupants that a fire alarm condition has been reported. The message shall instruct the occupants with emergency instructions. All notification shall be speaker/strobes or strobe lights.
- E. The work shall include all required programming to allow proper sequence and operation as required by code. Final programming shall be done based on the actual physical room names and numbers used on site, if different from the room names or numbers on the approved plans.
- F. Provide CBC 2019 compliant seismic installation. See Section 26 0500 for all certification and submittal requirements.
- G. All work shall comply with Sections 26 0500 and 26 2700.

**1.02 SCOPE**

- A. This specification outlines the requirements for a microprocessor based, addressable (intelligent) automatic fire detection and alarm system. The system and components shall be supplied by one manufacturer of established reputation and experience who shall have produced similar apparatus for a period of at least five (5) years and who shall be able to refer to similar installations in public buildings rendering satisfactory service.
- B. The work described in this specification consists of all labor, materials, equipment and services necessary and required to complete and program and test the automatic fire detection and alarm system. Any material not specifically mentioned in this specification or not shown on drawings but required for proper performance and operation shall be furnished, installed, and connected complete.

- C. Where a networked system is indicated on the drawings, the work shall include all required programming to allow network operation between each control panel, for central monitoring from the Main FACP.
- D. Final system programming (or re-programming for existing systems) shall be done based on the actual physical room names and numbers used on site, if different from the room names or numbers on the approved plans.

### 1.03 REQUIREMENTS

- A. This installation shall be made in accordance with the drawings, specification and the following:
  - 1. National Electrical Code Article 760
  - 2. NFPA Standard 72
  - 3. Local Codes and Authorities Having Jurisdiction
  - 4. ADA requirements and regulations.
- B. Fire Watch:
  - 1. Provide an AHJ approved Fire Watch plan and Fire Watch for any portion of the fire alarm system that is left inoperative in a normally occupied building.
  - 2. At no time during the project shall a normally occupied building, or portion thereof that remains occupied, be left without a functioning fire alarm system, unless an approved Fire Watch is provided.
  - 3. Include all required planning and labor for a Fire Watch, where required.

### 1.04 RELATED WORK

- A. Division 26: Basic materials and methods
- B. Division 21: Fire protection systems
- C. Division 23: HVAC systems
- D. Division 23: Fire Smoke Dampers

### 1.05 FIRE ALARM SYSTEM DESCRIPTION

- A. The system shall be a supervised, non-coded, 24 volt DC, power limited system, networked if indicated on the drawings, and shall be capable of having all addressable initiation devices on the system in alarm at one time. Notification device circuits shall be wired Class B. Initiation device circuits shall also be wired Class B. A single ground or open on any initiating device circuit or notification appliance circuit shall not cause system malfunction, loss of operating power, or the ability to report an alarm.
- B. Provide initiation, notification and other devices as per specifications and indicated on drawings.
- C. Indicate alarms, supervisory, and trouble signals on the main fire alarm control panel and annunciator at each building and at the building fire alarm control panel in a networked system.
- D. Initiate signals to control (shut-off) HVAC system units and FSD's as per drawings and as required by code.
- E. Transmit alarm signals to off-site reporting agency via a digital communicator at each fire alarm control panel, with specific building address ID.
- F. The fire alarm system shall function as follows when any smoke or duct detector, waterflow switch, manual station or other initiating device operates:
  - 1. Operate required audible/visual and visual devices indicated on the drawings.
  - 2. Automatically notify off-site reporting agency.



3. Indicate at the control panel alphanumeric display the number and location of the alarmed device.
  4. Light an indicating lamp on the smoke detector initiating the alarm.
  5. Light an indicating lamp on the remote annunciator indicating the location alarmed as well as the type of device alarmed (area smoke detector, duct detector, manual pull station, waterflow switch, kitchen fire suppression system panel, valve supervisory switch, etc.).
- G. Provide additional system features and capacities as indicated in Part 2 of this Section of the Specifications.

**1.06 GUARANTEE**

- A. All work performed and all material and equipment furnished under this contract shall be free from defects and shall remain so for a period of at least one (1) year from the date of acceptance.

**1.07 APPLICABLE PUBLICATIONS**

The publications listed below form a part of this specification.

- A. National Fire Protection Association (NFPA) - USA:

No. 70 National Electrical Code (NEC)

No. 72 National Fire Alarm Code

No. 101 Life Safety Code

- B. Underwriters Laboratories Inc. (UL) - USA:

No. 268 Smoke Detectors for Fire Protective Signaling Systems

No. 864 Control Units for Fire Protective Signaling Systems

No. 268A Smoke Detectors for Duct Applications

No. 521 Heat Detectors for Fire Protective Signaling Systems

No. 464 Audible Signaling Appliances

No. 1971 Visual Signaling Appliances

No. 38 Manually Actuated Signaling Boxes

No. 346 Waterflow Indicators for Fire Protective Signaling Systems

- C. Local and State Building Codes.

- D. All requirements of the Authority Having Jurisdiction (AHJ).

**1.08 APPROVALS**

- A. Fire alarm control panels and all peripherals shall have proper listing and/or approval from Underwriters Laboratory (UL) and be California State Fire Marshall listed and approved.

## **PART 2 - PRODUCTS**

### **2.01 EQUIPMENT AND MATERIAL, GENERAL**

- A. All equipment and components shall be new, and the manufacturer's current model.
- B. The system shall be UL 864 (9th Edition) listed.
- C. Acceptable System Manufacturers:
  - 1. Notifier (to match existing at facility).
- D. All equipment and components shall be installed in strict compliance with manufacturers' recommendations.
- E. All Equipment shall be attached to and ceiling/floor assemblies and shall be held firmly in place. (e.g., detectors shall not be supported solely by suspended ceilings). Fasteners and supports shall be adequate to support the required load.

### **2.02 CONDUIT, BOXES, AND WIRE**

- A. All conduit and wire shall comply with section 26 27 00 of these specifications.
- B. Conduit:
  - 1. Conduit shall be in accordance with The National Electrical Code (NEC), local and state requirements.
  - 2. Conduit fill shall not exceed 40 percent of interior cross sectional area where three or more cables are contained within a single conduit.
  - 3. Cable must be separated from any open conductors of Power, or Class 1 circuits, and shall not be placed in any conduit, junction box or raceway containing these conductors, as per NEC Article 760-29.
  - 4. Conduit shall be 3/4 inch minimum.
- C. Wire:
  - 1. All fire alarm system wiring shall be new and installed in conduit. All wiring shall be in conformance with fire alarm system manufacturer's requirements.
  - 2. Wiring shall be in accordance with local, state and national codes (e.g., NEC Article 760). Number and size of conductors shall be as recommended by the fire alarm system manufacturer, but not less than 16 AWG for initiating device circuits and signaling line circuits, and 12 AWG for Notification device circuits.
  - 3. All field wiring shall be completely supervised, Class B for initiation loops, and Class B also for notification loops with end-of-line devices located as shown on the riser diagram.
  - 4. If indicated on the drawings, Class A loops shall be used for initiation circuits, and shall always include a return cable to the fire alarm panel terminals, per Class A and manufacturer's wiring requirements.
  - 5. All cable used in conduit outdoors or underground shall be Outside Plant Rated.
  - 6. Network communications loop shall be a 50/125 multi-mode fiber optic outside plant cable installed in inner-duct in the fire alarm site conduit and shall link all control panels if networked system is indicated on the drawings.
- D. Terminal Boxes, Junction Boxes and Cabinets:
  - 1. All boxes and cabinets shall be UL listed for their use and purpose.
- E. Each Fire Alarm Control Panel and expander panel shall be connected to a separate dedicated branch circuit, maximum 20 amperes. This circuit shall be labeled at the power panel as FIRE ALARM and include a breaker handle lock for the dedicated breaker. Fire alarm control panel primary power wiring shall be #12 AWG. The control panel cabinet shall be properly grounded.
  - 1. For buildings with elevators, the elevator shunt-trip circuit shall be a dedicated 20 amperes branch circuit. This circuit shall also be labeled at the power panel as FIRE

ALARM ELEVATOR SHUNT TRIP and include a breaker handle lock for the dedicated breaker.

### 2.03 CONTROL PANEL

- A. The control panel shall be microprocessor based and totally power limited. The panel shall be capable of supporting Class A (Style 6) or Class B (Style 4) Network Communications lines, and Class A (Style Z) or Class B (Style Y) Notification Circuits. The panel shall have the following features; Totally Field Programmable, Password Access Protection, Built in Panel Diagnostics, Alarm and Trouble Resound, Alarm Event Buffer, Trouble Status Buffer, Point Identification Display, 24 hour Trouble resound, One Man Walk Test, Alarm Verification, and Positive Alarm Sequence. The panel (and expander panels where required) shall include audio amplifiers and related components to support the voice evacuation requirements. The panel shall have the following relays with a form C configuration; Alarm, Trouble, Supervisory, and Default Alarm Mode (to allow alarm reporting during microprocessor failure).
- B. The control panel shall be designed to monitor and process a minimum of 198 addressable inputs (smoke detectors, manual stations water flow devices, etc.), and up to 198 addressable monitor or control modules. The Network Communication Lines shall support various annunciation devices (i.e. LED Annunciators, Alphanumeric Displays, Printers) in addition to the addressable inputs and outputs described above. The system architecture shall allow for T-tapping of the Network Communications Lines. The use of a Zone Monitor module on the Communications Line shall further enhance the system with a master/slave concept, allowing a group of conventional detection devices (standard smoke detectors manual stations, waterflow and tamper switches) to be interfaced into the system as an address point. The system shall include individual power supply expander panels as required to support the notification loops. Each notification circuit shall be independently field programmable by the use of addressable control modules rated for the required current.
- C. The control panel shall contain an Alphanumeric Display interface which contains a microprocessor with a non-volatile memory to store field programmable alarm and trouble messages. The Alphanumeric Display shall consist of two 40 character lines for alarm, supervisory and trouble identification, and in quiescent mode, indicates system status.
- D. The control panel shall have history reporting, with the history stored in either the alphanumeric or printer modules. The history shall be at least 1,000 events. These events can be alarm, verification, supervisory, trouble, acknowledge, system reset, walk test, and the use of any panel keypad keys and access to any panel modes such as Program or Test.
- E. The control panel shall have self-diagnosis. Once the program is stored in memory and upon system initiating, if there is a discrepancy between the number of devices entered into the program and the actual number of devices connected to the system, the panel shall annunciate a trouble for the devices in question.
- F. Power Supply
  1. The Power Supply for the Fire Alarm Control Panel may be integral or external to the Fire Alarm Control Panel, and shall provide all control panel and peripheral device power needs. Additional power required to operate all alarm devices (above and beyond the capacity of the main panel supply) shall be provided with power expander panel(s), connected to the alarm output of the main control panel. Provide all required interface modules and relays for proper notification circuit operation as per manufacturer's instructions. Expander panel shall be as manufactured by the chosen Fire Alarm System manufacturer (qty. as required for full alarm operation).
  2. Input power shall be provided at 120 VAC, 60 HZ. The power supply shall provide an integral battery charger for use with a minimum of 12 AH batteries.

3. It shall provide a minimum of 6.0 amperes of regulated 24 VDC power for Audio-Visual alarm notification devices, 200 mA of smoke detector power, and 200 mA of Non-Resettable power.
  4. The power supply shall be designed to meet UL and NFPA requirements for power-limited operation on all initiating and notification circuits.
  5. Positive-temperature-coefficient thermistors, circuit breakers, fuses, or other over-current protection shall be provided on all power outputs.
- G. Mechanical Design: The control panel shall be housed in a cabinet designed for mounting directly to a wall or vertical surface. The back box and door shall be constructed of .060 steel with provisions for electrical conduit connections into the sides and top. No conduit penetrations shall be utilized on the back or bottom of the panel. The door shall provide a key lock and shall include a glass or other transparent opening for viewing of all indicators. The cabinet shall be approximately 5 inches deep and 14.5 inches wide. Height shall be approximately 16 inches.
- H. The control panel shall have the exact model number and manufacturer's name indicated on the front panel cover.

#### 2.04 INITIATION DEVICES

- A. Addressable photoelectric smoke detectors, (intelligent), shall be provided as indicated on the drawings, with features and characteristics as follows:
1. The detector shall be self-compensating for ambient temperature and humidity.
  2. The detector shall be addressed, tested and programmed prior to installation using a UL listed programmer/tester. The detector readout shall yield a discrete electrical value for status tracking and logging for determining maintenance and cleaning requirements.
  3. The detector shall be suitable for two wire operation and two way communication on the intelligent analog signaling circuits.
  4. The detector shall display a flashing red LED when in the alarm state when the system is operating from normal or standby power.
  5. The detectors furnished shall be listed for use in environments as covered by Factory Mutual, UL and shall be installed according to the requirements of NFPA 72 for open area coverage.
  6. Detectors for magnetic door hold open functions shall be provided with an auxiliary relay base for auxiliary function wiring connections.
    - a. Door holder power shall be routed via the relay base on smoke detectors denoted with an "R" to release the associated doors upon alarm.
- B. Heat detectors shall be provided as indicated on drawings. Heat detector shall be of the rate compensation type, 135 degree.
- C. Duct Detectors:
1. Duct detectors for air-handling units, complete with all required sampling tubes and housings, shall be provided and connected complete by this contractor, installed by Division 23. Coordinate with Division 23.
  2. Duct Detectors shall be connected to the air handler starter unit, in order to facilitate unit shut-down upon alarm (via an auxiliary relay in the duct detector). Coordinate exact control wiring with Division 23. Provide and install all required wiring and conduit for starter/duct detector interface.
  3. Provide and install power connection to each duct detector as required. Coordinate with Division 23.
  4. Provide Nema 3R exterior rated housings for all exterior duct detectors.
- D. Manual stations, (intelligent), shall be single action and semi-flush or surface mounted as indicated on the drawings.

1. The manual station shall be equipped with a terminal strip and pressure style screw terminals for the connection of field wiring.
  2. The manual stations shall be addressable and identifiable by the fire alarm control panel when they are resident on the analog loop. Address programming shall be accomplished electronically and reside within the station in non-volatile memory.
- E. A monitor module interface device shall be provided for required interface points such as water flow devices and tamper switches, or any contact type devices as indicated on drawings. This interface device shall have one or two Class B (Style 4) circuits as required.
- F. Provide a 120VAC circuit connection to each sprinkler system water flow bell (provided by Division 21). Wire power via the local water flow switch auxiliary contact to ring the bell upon water flow activation.

#### **2.05 REMOTE ANNUNCIATOR**

- A. A remote annunciator shall be provided as indicated on the drawings. The annunciator shall be wall mounted in a multi-gang box or as required. It shall provide a 80 character display to indicate the zone(s) in alarm and LED's for system trouble and supervisory conditions.
- B. The annunciator shall include a lockable and latched door with glass front to allow viewing of all indicators.
- C. The annunciator shall include a local sounder with reset and alarm acknowledge, including key lock-out.

#### **2.06 BATTERIES**

- A. Batteries shall be 12 volt, sealed type, with combined Amp-Hour ratings as required by Code.
- B. Battery shall have a minimum sufficient capacity to power the fire alarm system for not less than twenty-four hours in standby mode, plus 15 minutes of full system alarm upon a normal AC power failure.
- C. The batteries are to be completely maintenance free, no liquids required. Fluid level checks, refilling, spills and leakage control shall not be required.

#### **2.07 CONTROL DEVICES**

- A. Control modules shall be provided as indicated on the drawings for fire alarm output functions. These devices shall be connected to the Network Communications Lines, and be field programmable for one of the following options; Remote Relay (form C 1amp 24vdc, 200ma 120vac) with supervised relay operation; Remote Supervised Indicating Appliance Circuit ( fused at 1 amp). There shall be an LED on the device that shall flash to indicate the unit is being monitored and a steady LED to indicate the unit has been activated. Secondary relays with control power connections shall be provided as required where contact ratings (voltage & amps) so dictate.

#### **2.08 NOTIFICATION DEVICES**

- A. Speaker / Strobe Notification Devices:
1. All speakers shall operate on 70.7 VRMS, with field selectable output taps from 1/8 to 2 Watts in 3dB steps. Frequency response shall be a minimum of 400 HZ to 4 KHZ.
    - a. Speaker circuits shall have 20% space capacity for future expansion or increased power output requirements. All speaker tap settings shall be set per recommended settings (minimum 1/4 watt) for area coverage, and shall be re-tapped as required after final testing to provide adequate audible coverage throughout each area (to meet NFPA requirements).
    - b. Speaker circuits and control equipment shall be arranged such that loss of any one (1) speaker circuit will not cause the loss of any other speaker circuit in the system.

- c. Provide amplifier modules as required to carry the full designed load, plus 20% spare capacity. Provide (1) additional back-up amplifier module for automatic back up of any failed amplifier module.
  - d. Speaker/Strobe combinations shall be provided as indicated on Drawings. The speaker / strobe combination shall be Wheelock or equal, ADA and UL 1971 compliant (candela values as required) - white finish.
- B. Strobe Lights shall be provided as indicated on drawings. The strobe lights shall be either ceiling mounted, or wall mounted at +80" AFF or 6" below the ceiling level, whichever is lower, Wheelock or equal, ADA and UL 1971 compliant (candela values as required) - White finish. See drawings for locations.
- C. Refer to Part 3 below for required synchronization of strobes when located in the same field of view.

## **2.09 FIRE / SMOKE DAMPER**

- A. Fire / Smoke dampers (FSD's) are provided and installed by Division 23. This contractor shall provide and install a 120V power connection to each damper, wired to keep the damper in the open position under normal conditions.
- B. An integral duct smoke detector shall be provided by Division 23. This contractor shall provide and install an addressable monitor module, connected to the alarm contacts on the duct detector, to monitor the condition of the detector and annunciate an alarm condition to the main control panel upon detection of smoke.
- C. This contractor shall wire the 120V control power for the FSD's via an auxiliary alarm contact in the detector base, to automatically close the damper upon smoke detection. Coordinate all provisions with Division 23.
- D. All FSD provisions shall comply with the applicable sections and requirements of the CEC, CFC, CBC and the local AHJ.
- E. Every effort has been made to indicate all required damper locations at rated partitions in coordination with Division 23 work. This contractor shall coordinate with the sub-mechanical contractor to identify all required locations for FSD's and provide connections to all units as required by Code. The architectural drawings indicate by symbol, all such rated partitions. No extra cost shall be approved for additional required connections not shown on the drawings.

## **2.10 AUDIO AMPLIFIERS**

- A. The Audio Amplifiers shall provide audio power at 70.7 Volts RMS for distribution to speaker circuits.
- B. Multiple audio amplifiers shall be mounted in the FACP, or at the FACP or expander panel locations, either to supply incremental audio power, or to function as an automatically switched backup amplifier(s).
- C. The audio amplifiers shall include an integral power supply, and shall provide the following controls and indicators:
  - 1. Normal Audio Level LED
  - 2. Incorrect Audio Level LED
  - 3. Brownout LED
  - 4. Battery Trouble LED
  - 5. Amplifier Trouble LED

## **2.11 AUDIO AMPLIFIER GAIN ADJUST**

- A. Adjustment of the correct audio level for the amplifier shall not require any special tools or test equipment.

- B. Amplifiers shall include audio input and amplified output supervision; back up input, and automatic switch over function, (if primary amplifier should fail).
- C. Amplifiers shall be backed up in groups (1 amplifier backs up several at the same location). Failure of any one amplifier in the system shall not degrade system performance in any way

#### **2.12 AUDIO MESSAGE GENERATOR (PRERECORDED VOICE)**

- A. Each initiating zone or intelligent device shall interface with an emergency voice communication system capable of transmitting a prerecorded voice message to all speakers in the building.
- B. Activation of any alarm-initiating device shall cause a prerecorded message to sound over the designated speakers. The message shall be repeated a minimum of four (4) times.
- C. A built in microphone shall be provided to allow paging through speaker zone circuits.
- D. The audio message generator shall have the following controls and indicators to allow for proper operator understanding and control:
  - 1. All Call LED
  - 2. On Line LED
- E. All Call Switch Local Speaker Volume Control Local (Test) Speaker

#### **2.13 SPEAKER CIRCUIT CONTROL SWITCHES / INDICATORS**

- A. The speaker circuit control switches/indicators shall include visual indication of active and trouble status for each speaker circuit in the system.
- B. The speaker circuit control panel shall include switches to manually activate or deactivate each speaker circuit in the system.

### **PART 3 - EXECUTION**

#### **3.01 INSTALLATION**

- A. Installation, programming and testing shall be performed by current factory-authorized contractor of the specified system.
- B. Installation shall be in accordance with the NEC, NFPA 72, local and state codes, as shown on the drawings, and as recommended by the major equipment manufacturer.
- C. All conduit, junction boxes, conduit supports and hangers shall be concealed in finished areas and may be exposed in unfinished areas. Smoke detectors shall not be installed prior to the system programming and test period. If construction is ongoing during this period, measures shall be taken to protect smoke detectors from contamination and physical damage.
- D. All fire detection and alarm system devices, control panels and remote annunciators shall be flush mounted when located in finished areas and may be surface mounted when located in unfinished areas.
- E. Provide identification labeling on all devices to identify loop and device number/address. Labeling shall consist of min. 3/8" black lettering on white background P-Touch style adhesive labels with machine printing, Helvetica font or similar.
- F. At the final inspection a factory trained representative of the manufacturer of the major equipment shall perform the tests in Section 3.2 TESTING.
- G. Wiring:
  - 1. See Part 1 of this Section of the Specification and the drawings for wiring requirements.
  - 2. When (3) or more visual notification devices are located within the same field of view and are less than 55 feet apart (within the field of view), all devices within that field of view shall be synchronized to provide the same flash rate and frequency. Provide all required sync modules and compatible strobe devices to provide a synchronized output.

### 3.02 PROGRAMMING

- A. Provide system programming as required by code to provide a fully functional system. Final programming shall be done based on the actual physical room names and numbers on site, if different from the room names or numbers on the approved plans.
- B. Include changes to existing system programming (if existing), to accommodate the new devices and equipment, as well as any sequence of operation changes.

### 3.03 TESTING

- A. Provide the service of a competent, factory trained engineer or technician authorized by the manufacturer of the fire alarm equipment to technically supervise and participate during all of the adjustments and tests for the system. Each building shall be separately tested as completed and where a networked system is indicated on the drawings, the entire networked system tested just prior to project completion. Include contractor pre-test for each building prior to the final AHJ testing to insure a suitable final test result.
  - 1. Before energizing the cables and wires, check for correct connections and test for short circuits, ground faults, continuity, and insulation.
  - 2. Close each sprinkler system flow valve and verify proper supervisory alarm at the respective FACP and/or annunciator.
  - 3. Verify activation of all flow switches.
  - 4. Open initiating device circuits and verify that the trouble signal actuates at the respective FACP and/or annunciator.
  - 5. Open and short all notification appliance circuits and verify that trouble signals actuate at the respective FACP and/or annunciator.
  - 6. Ground circuits and verify response of trouble signals at the respective FACP and/or annunciator.
  - 7. Check presence and audibility of tone at all alarm notification devices.
  - 8. Check installation, supervision, and operation.
  - 9. Verify that each initiating device alarm is properly received and processed by the respective FACP and annunciator (Walk Test).
  - 10. Conduct tests from each FACP to verify trouble indications for common mode failures, such as alternating current power failure.
- B. Test reports shall include, but not be limited to:
  - 1. A complete list of equipment installed indicating proper operations as listed above.

### 3.04 FINAL INSPECTION

- A. Final acceptance will require the contractor to deliver to the Owner the following:
  - 1. Three (3) copies of the operating instructions and system maintenance manuals.
  - 2. Three (3) set of record drawings.
  - 3. Three (3) copies of the final test reports.
  - 4. Three (3) copies indicating the name and phone number of person to contact in the event of equipment failure, and date when system warranty will be terminate.
  - 5. Three (3) sets of data sheets for each piece of equipment supplied.
- B. The fire alarm system subcontractor or manufacturer shall offer for the owner's consideration at the time of system submittal a priced inspection, maintenance, testing and repair contract in full compliance with the requirements of NFPA 72.
  - 1. The services offered under this contract shall be performed at no charge during the first year after system acceptance and the owner shall have the option of renewing for single or multiple years, up to five years, at the price quoted in bid.



2. The contractor performing the contract services shall be qualified and listed to maintain ongoing certification of the completed system to the UL for specific installed system listing.

**3.05 GUARANTEE**

- A. See Part 1 of this Section of the Specifications.

**3.06 INSTRUCTION**

- A. Provide complete instruction manuals and training to the building personnel. "Hands-on" demonstrations of the operation of all system components and the entire system shall be provided.

**END OF SECTION**

## SECTION 31 1000

### SITE CLEARING

#### PART 1 - GENERAL

##### 1.1 RELATED DOCUMENTS

- A. Drawings and general provisions of the Contract, including General and Supplementary Conditions and Division 01 Specification Sections, apply to this Section.

##### 1.2 SUMMARY

- A. Section Includes:
  - 1. Protecting existing vegetation to remain.
  - 2. Removing existing vegetation.
  - 3. Clearing and grubbing.
  - 4. Stripping and stockpiling topsoil.
  - 5. Removing above- and below-grade site improvements.
  - 6. Disconnecting, capping or sealing, and abandoning site utilities in place.
  - 7. Temporary erosion- and sedimentation-control measures.
- B. Related Sections:
  - 1. Section 01 7300 "Execution" for field engineering and surveying.

##### 1.3 DEFINITIONS

- A. Subsoil: All soil beneath the topsoil layer of the soil profile, and typified by the lack of organic matter and soil organisms.
- B. Surface Soil: Soil that is present at the top layer of the existing soil profile at the Project site. In undisturbed areas, the surface soil is typically topsoil; but in disturbed areas such as urban environments, the surface soil can be subsoil.
- C. Topsoil: Top layer of the soil profile consisting of existing native surface topsoil or existing in-place surface soil and is the zone where plant roots grow.
- D. Topsoil: Top layer of the soil profile consisting of existing native surface topsoil or existing in-place surface soil and is the zone where plant roots grow. Its appearance is generally friable, pervious, and black or a darker shade of brown, gray, or red than underlying subsoil; reasonably free of subsoil, clay lumps, gravel, and other objects more than 2 inches in diameter; and free of subsoil and weeds, roots, toxic materials, or other non-soil materials.
- E. Plant-Protection Zone: Area surrounding individual trees, groups of trees, shrubs, or other vegetation to be protected during construction, and indicated on Drawings.
- F. Vegetation: Trees, shrubs, groundcovers, grass, and other plants.

1.4 MATERIAL OWNERSHIP

- A. Except for stripped topsoil and other materials indicated to be stockpiled or otherwise remain Owner's property, cleared materials shall become Contractor's property and shall be removed from Project site.

1.5 INFORMATIONAL SUBMITTALS

- A. Existing Conditions: Documentation of existing trees and plantings, adjoining construction, and site improvements that establishes preconstruction conditions that might be misconstrued as damage caused by site clearing.
  - 1. Use sufficiently detailed photographs or videotape.
  - 2. Include plans and notations to indicate specific wounds and damage conditions of each tree or other plants designated to remain.
- B. Record Drawings: Identifying and accurately showing locations of capped utilities and other subsurface structural, electrical, and mechanical conditions.

1.6 QUALITY ASSURANCE

- A. Preinstallation Conference: Conduct conference at Liberty High School at 20 Oak Street, Brentwood, CA.

1.7 PROJECT CONDITIONS

- A. Salvable Improvements: Carefully remove items indicated to be salvaged and store on Owner's premises.
- B. Utility Locator Service: Notify Call Before You Dig for area where Project is located before site clearing.
- C. Do not commence site clearing operations until temporary erosion- and sedimentation-control measures are in place.
- D. The following practices are prohibited within protection zones:
  - 1. Storage of construction materials, debris, or excavated material.
  - 2. Parking vehicles or equipment.
  - 3. Foot traffic.
  - 4. Erection of sheds or structures.
  - 5. Impoundment of water.
  - 6. Excavation or other digging unless otherwise indicated.
  - 7. Attachment of signs to or wrapping materials around trees or plants unless otherwise indicated.
- E. Do not direct vehicle or equipment exhaust towards protection zones.
- F. Prohibit heat sources, flames, ignition sources, and smoking within or near protection zones.

- G. Soil Stripping, Handling, and Stockpiling: Perform only when the topsoil is dry or slightly moist.

## PART 2 - PRODUCTS

### 2.1 MATERIALS

- A. Satisfactory Soil Material: Requirements for satisfactory soil material are specified in Section 31 2000 "Earthwork."
  - 1. Obtain approved borrow soil material off-site when satisfactory soil material is not available on-site.

## PART 3 - EXECUTION

### 3.1 PREPARATION

- A. Protect and maintain benchmarks and survey control points from disturbance during construction.
- B. Locate and clearly identify trees, shrubs, and other vegetation to remain or to be relocated. Wrap a 1-inch blue vinyl tie tape flag around each tree trunk at 54 inches above the ground.
- C. Protect existing site improvements to remain from damage during construction.
  - 1. Restore damaged improvements to their original condition, as acceptable to Owner.

### 3.2 TEMPORARY EROSION AND SEDIMENTATION CONTROL

- A. Provide temporary erosion- and sedimentation-control measures to prevent soil erosion and discharge of soil-bearing water runoff or airborne dust to adjacent properties and walkways, according to erosion- and sedimentation-control Drawings and requirements of authorities having jurisdiction.
- B. Verify that flows of water redirected from construction areas or generated by construction activity do not enter or cross protection zones.
- C. Inspect, maintain, and repair erosion- and sedimentation-control measures during construction until permanent vegetation has been established.
- D. Remove erosion and sedimentation controls and restore and stabilize areas disturbed during removal.

### 3.3 TREE AND PLANT PROTECTION

- A. General: Protect trees and plants remaining on-site according to requirements in Section 015639 "Temporary Tree and Plant Protection."

- B. Repair or replace trees, shrubs, and other vegetation indicated to remain or be relocated that are damaged by construction operations, in a manner approved by Architect.

### 3.4 EXISTING UTILITIES

- A. Owner will arrange for disconnecting and sealing indicated utilities that serve existing structures before site clearing, when requested by Contractor.
  - 1. Verify that utilities have been disconnected and capped before proceeding with site clearing.
- B. Locate, identify, disconnect, and seal or cap utilities indicated to be removed or abandoned in place.
  - 1. Arrange with utility companies to shut off indicated utilities.
  - 2. Owner will arrange to shut off indicated utilities when requested by Contractor.
- C. Locate, identify, and disconnect utilities indicated to be abandoned in place.
- D. Interrupting Existing Utilities: Do not interrupt utilities serving facilities occupied by Owner or others unless permitted under the following conditions and then only after arranging to provide temporary utility services according to requirements indicated:
  - 1. Notify Architect not less than two days in advance of proposed utility interruptions.
  - 2. Do not proceed with utility interruptions without Architect's written permission.
- E. Excavate for and remove underground utilities indicated to be removed.
- F. Removal of underground utilities is included in earthwork sections and with applicable fire suppression, plumbing, HVAC, electrical, communications, electronic safety and security and utilities sections and Section 024116 "Structure Demolition" and Section 024119 "Selective Demolition."

### 3.5 CLEARING AND GRUBBING

- A. Remove obstructions, trees, shrubs, and other vegetation to permit installation of new construction.
  - 1. Do not remove trees, shrubs, and other vegetation indicated to remain or to be relocated.
  - 2. Grind down stumps and remove roots, obstructions, and debris to a depth of 18 inches below exposed subgrade.
  - 3. Use only hand methods for grubbing within protection zones.
  - 4. Chip removed tree branches and dispose of off-site.
- B. Fill depressions caused by clearing and grubbing operations with satisfactory soil material unless further excavation or earthwork is indicated.
  - 1. Place fill material in horizontal layers not exceeding a loose depth of 8 inches, and compact each layer to a density equal to adjacent original ground.

### 3.6 TOPSOIL STRIPPING

- A. Remove sod and grass before stripping topsoil.
- B. Strip topsoil to depth of 3 inches in a manner to prevent intermingling with underlying subsoil or other waste materials.
  - 1. Remove subsoil and non-soil materials from topsoil, including clay lumps, gravel, and other objects more than 2 inches in diameter; trash, debris, weeds, roots, and other waste materials.
- C. Stockpile topsoil away from edge of excavations without intermixing with subsoil. Grade and shape stockpiles to drain surface water. Cover to prevent windblown dust and erosion by water.
  - 1. Limit height of topsoil stockpiles to 60 inches.
  - 2. Do not stockpile topsoil within protection zones.
  - 3. Dispose of surplus topsoil. Surplus topsoil is that which exceeds quantity indicated to be stockpiled or reused.
  - 4. Stockpile surplus topsoil to allow for respreading deeper topsoil.

### 3.7 SITE IMPROVEMENTS

- A. Remove existing above- and below-grade improvements as indicated and necessary to facilitate new construction.
- B. Remove slabs, paving, curbs, gutters, and aggregate base as indicated.
  - 1. Unless existing full-depth joints coincide with line of demolition, neatly saw-cut along line of existing pavement to remain before removing adjacent existing pavement. Saw-cut faces vertically.
  - 2. Paint cut ends of steel reinforcement in concrete to remain with two coats of antirust coating, following coating manufacturer's written instructions. Keep paint off surfaces that will remain exposed.

### 3.8 DISPOSAL OF SURPLUS AND WASTE MATERIALS

- A. Remove surplus soil material, unsuitable topsoil, obstructions, demolished materials, and waste materials including trash and debris, and legally dispose of them off Owner's property.
- B. Separate recyclable materials produced during site clearing from other nonrecyclable materials. Store or stockpile without intermixing with other materials and transport them to recycling facilities. Do not interfere with other Project work.

**END OF SECTION 31 1000**

## SECTION 31 2000

### EARTHWORK

#### 1. PART- GENERAL

##### 1.1 RELATED DOCUMENTS

- A. All earthwork shall be in conformance with the soils report.
- B. Drawings and general provisions of the contract, including General and Supplementary Conditions and Division I Specification Section, apply to this section.
- C. Published specifications, standards, tests, or recommended methods of trade, industry, or governmental organizations apply to Work of this Section where cited by abbreviations noted below (latest editions apply unless otherwise noted).
  - 1. California Code of Regulations, Title 24, 2013 edition, also known as California Building Code (CBC).
  - 2. American Society for Testing and Materials (ASTM).
  - 3. American Association of State Highway and Transportation Officials (AASHTO), "Standard Specifications for Highway Materials and Methods of Sampling and Testing."
  - 4. State of California, Business and Transportation Agency, Department of Public Works, Division of Highways:
    - (a) "Standard Specifications."
    - (b) "Materials Manual," (CMM).

##### 1.2 SUMMARY

- A. Section Includes:
  - 1. Excavation including removal of known on- or below-grade construction or obstructions, and filling and backfilling.
  - 2. Provision of rock courses, sand beds, and vapor retarders under slabs on grade.
- B. Related Sections include:
  - 1. Section 31 2333 "Trenching and Backfill" for trenching and backfilling underground utilities and detectable warning tapes.

##### 1.3 DEFINITIONS:

- A. Compaction: Ratio expressed as percentage of dry density of material compacted in field to maximum dry density of same material as determined by ASTM 01557.

#### 1.4 QUALITY ASSURANCE

- A. Regulatory Requirements:
  - 1. Comply with rules and regulations of local and State agencies having jurisdiction.
  - 2. Comply with State and local code requirements for disposal of debris.
- B. Allowable Tolerances:
  - 1. Excavations shall not exceed 1/10-foot variation from dimensions and elevations shown or noted on plans.
  - 2. Fill and backfill shall be placed within tolerance of plus or minus 1/10-foot.

#### 1.5 PROJECT CONDITIONS

- A. Existing Conditions:
  - 1. Carefully maintain benchmarks, monuments, and survey control references.
  - 2. Verify or determine locations of underground utilities and avoid damage. Should damage occur, notify the Architect and repair at no additional cost to the Contract.
  - 3. Restore grades disturbed by construction activity or other causes to elevations shown or noted.
- B. Environmental Requirements: When unfavorable weather conditions necessitate interrupting filling and grading operations, prepare areas by compaction of surface and grading to avoid collection of water. Provide adequate temporary drainage to prevent erosion. After interruption, re-establish compaction specified in last layer before resuming work.
- C. Protection: Conduct earthwork operations so as to prevent windblown dust and dirt from interfering with the Owner's and adjacent property owner's normal operations. Assume liability for all claims related to windblown dust and dirt. Protect building structures and adjacent surfaces to remain.
- D. Sequencing: Sequence operations so as to maintain safe working conditions and preserve existing Work which is to remain.
- E. Layout: If any discrepancies are found by Surveyor between Drawings and actual conditions at Site, Architect reserves right to make such minor adjustments in Work specified hereunder, as are necessary to accomplish the intent of the Contract Documents, at no increase in Contract price.



**1.6 RECORDS OF INVESTIGATION**

- A. The following record of investigation is available as a reference for the Contractor:
1. Title: Geotechnical Investigation Report and Geologic Hazard Assessment, Liberty High School Campus Expansion
  2. Author: BSK Associates
  3. Date: April 11, 2018
  4. Availability: Available for reference at the offices of the author of the report and the Architect.

**1.7 RESPONSIBILITY FOR ACCURACY OF SITE DATA**

- A. The Contractor shall promptly, and before such condition is disturbed, notify the Architect in writing of soil or subsurface conditions which differ materially from those conditions shown in the Contract Documents or in the records of investigations of soil or subsurface conditions referred to above. The Architect shall promptly investigate the conditions. If he finds the conditions materially different from those which reasonably should have been anticipated on the basis of a careful consideration of said records of investigations, logs of borings and examination of the site, and finds that said conditions will cause an increase or decrease in the cost of, and/or the time required for performance of the Contract, he will, after approval by the Owner, modify the Contract Terms in writing to provide for an equitable adjustment in cost and/or time of performance. Any claim of the Contractor shall not be allowed unless he has given the required written notice.

## **2. PART 2 PRODUCTS**

### **2.1 MATERIALS**

- A. All earthwork shall be in conformance with the soils report.
- B. Typical Fill and Backfill:
  - 1. Granular, not showing excessive shrinkage or swelling when subjected to changes in water content.
  - 2. Free of organic matter and other deleterious substances and containing no rocks or lumps over 3-inches in greatest dimension.
  - 3. All fill material shall be moisture conditioned to at least 3-percent over optimum moisture content as determined by ASTM D1557.
  - 4. On-site soils may be used as fill material except where granular fill material is specified. The moisture content must be within the above limits to be acceptable. Some drying of on-site soils may be required.
  - 5. Conform to the following minimum requirements:
    - (a) Maximum Plasticity Index: 15.
    - (b) Liquid Limit: Less than 30%.
    - (c) % Passing #200 Sieve: 8% - 40%

## **3. PART 3 EXECUTION**

### **3.1 INSPECTION**

- A. The Contractor shall be deemed to have inspected site and informed himself of actual grades, levels, and other conditions under which Work is to be performed.

### **3.2 EXCAVATION**

- A. All earthwork shall be in conformance with the soils report.
- B. General Requirements:
  - 1. Excavate to dimensions and elevations shown or noted with bottoms square and true.
  - 2. Remove debris, old foundations, tree stumps, and loose rocks from bottom of excavation.
  - 3. Shore, brace, sheet, and slope excavations as required to prevent caving, erosion, danger to persons and structures, or interference with construction operations and as required to comply with safety laws.

4. Keep excavation free of water at all times until concrete work and backfilling is complete. Grade excavated areas to provide drainage to prevent ponding of water.
- C. Excavated Soil Material: All excavated material determined unsuitable for use as fill or backfill or in excess of backfill requirements shall be removed from the site.
- D. Provisions for Formwork Construction:
  1. Extend excavations sufficient distance from walls and footings to permit placing and removal of forms, installation of services and inspection.
  2. Trim excavation walls and bottoms to reasonably smooth lines and grades.
- E. Earth Forms: The Contractor may excavate to dimensions of footing required in order to avoid constructing formwork, provided excavations are clean cut and free of spaces or cave-ins and provided the Owner's Soils Engineer approves. Continuous trenching for individual footings will not be permitted.
- F. Over-Depth Excavations: Rebuild to grade with lean concrete as directed by the Owner's Soils Engineer.
- G. Topsoil: Strip topsoil as directed by the Owner's Soils Engineer at the time of grading. The Contractor shall stockpile topsoil on the site as directed.
- H. Removal of On- or Below-Grade Construction or Obstructions:
  1. Remove known existing construction or obstructions including wells, vaults, walls, or otherwise enclosed spaces wherever they occur below new grade within immediate areas of new construction, new paving or new planted areas.
- I. Reworking of Holes, Depressions, Softened, or Disturbed Areas:
  1. Cut out the hole, depression, or unsuitable soil area to workable "cat" width or wider by use of "cat and blade" or similar means, cutting to firm subgrade at the bottom and sides.
  2. Compact the subgrade as specified hereinbefore.
  3. Fill as specified for structural backfill. "Hook" into the side of the excavation as each lift or fill is spread, as far as may be required to reach firm soil at the sides of the excavation and to bond new fill into the existing soil.
  4. Fill excavation in manner specified hereinbefore until a surface is obtained which is even and continuous with adjoining grade and offers a firm, even subgrade for final usage or placement of additional fill thereon.
- J. Dewatering:

1. Provide, operate, and remove dewatering equipment necessary to drain and keep excavations free of water under all circumstances.
2. Prevent surface water from flowing into excavation; promptly remove any water accumulated.
3. Dewatering system shall remain in place until construction Work below groundwater table is completed.

### 3.3 **FILLING AND BACKFILLING**

- A. All earthwork shall be in conformance with the soils report.
- B. General Requirements:
  1. Do not place fill or backfill until forms, rubbish and deleterious materials have been removed, waterproofing measures completed, and areas have been approved by the Architect.
  2. Scarify surface of area to receive fill to 12-inch depth and until surface is free from ruts, hummocks or other uneven features. Disc or blade scarify surface until free from large clods.
  3. Bring scarified material to proper moisture content and compact to specified density.
  4. Spread material in layers not to exceed 8-inch depth before compaction. Sprinkle material with sufficient moisture to compact properly; permit material with excess moisture to dry to proper water content. Thoroughly mix soil and water by blading and discing before compacting.
  5. Place granular backfill material as adjacent backfill is being placed.
  6. Adequately brace and shore footings, walls, etc., against which backfill is to be placed to prevent displacement or damage during placement. Do not remove shores or braces until permanent supports are in place and have attained their required strength.
  7. All fill material should be within 3-percent of optimum moisture contents as determined by ASTM 01557.
- C. Minimum Compaction Requirements:
  1. Subgrade under interior slabs: 90-percent
  2. Subgrade under footings: 90-percent
  3. Subgrade under pavements supporting automobile traffic: 95-percent
  4. All other fills: 90-percent

5. Do not compact soil in planting areas.

D. Compacting:

1. Compact by power tamping, rolling or combinations thereof as approved by the Owner's Soils Engineer. Where impractical to use rollers in close proximity to walls, stairs, etc., compact by mechanical tamping. Scarify and recompact any layer not attaining compaction until required density is obtained.

2. Compaction by flooding, ponding or jetting will not be permitted.

### 3.4 **SLAB BASE AND VAPOR RETARDER INSTALLATION**

A. All earthwork shall be in conformance with the soils report.

B. Rock Courses:

1. Verify that all improvements such as floor drains are installed.

2. Verify that the Owner's Soils Engineer has approved rough graded and compacted subgrade.

3. Place nominal 6-inch thick rock course under building slabs.

4. Level and compact to smooth surface.

C. Vapor Retarder Installation: Place vapor retarder sheeting with longest parallel with direction of pour. Lap seams 6" minimum and seal with manufacturer's recommended tape.

### 3.5 **GRADING**

A. All earthwork shall be in conformance with the soils report.

B. Begin grading only after debris and construction materials are removed from area concerned.

C. Grade areas to smooth, level or evenly sloped, uniform surface in conformity to contour lines and spot elevations noted. Make grades level where not otherwise indicated. Round smooth abrupt changes in slopes. Refill to required levels any settled grades. Slope ground away from building walls.

D. Ensure finished grades and surfaces conduct water directly to area drain, gutters, etc.

E. Place stockpiled topsoil in maximum 6-inch lifts to depth indicated. Scarify subgrade to minimum depth of 6-inches and obtain the Architect's approval before placing topsoil. Topsoil shall not be used for engineered fill.

F. Prevent erosion of freshly graded areas during construction and until permanent drainage and erosion control measures are installed. At cut slopes, place layer mesh and plant ground cover.

- G. After finish grading is completed, perform no further excavation or filling operations except by the Architect's approval and under observation of the Owner's Soils Engineer.

3.6 **FIELD QUALITY CONTROL**

- A. The Owner's Soils Engineer will:
  - 1. Sample and test fill material from source designated by the Contractor.
  - 2. Observe site preparation, excavation and placing and compacting of fill and backfill.
  - 3. Perform tests and inspections deemed necessary to ensure compliance with specifications.
  - 4. Issue final report to the Owner on grading and certification of compliance with specifications.
  - 5. Submit verified report to the DSA per CBC Section 1704A.
- B. The Contractor shall:
  - 1. Furnish access to site and facilities for inspection.
  - 2. Notify the Soils Engineer 48-hours prior to any fill or backfill operations.
  - 3. Pay costs for additional inspections and tests due to noncompliance with Contract Documents.

**END OF SECTION 31 2000**

## SECTION 31 2313

### SUBGRADE PREPARATION & BASE MATERIAL

#### PART 1 - GENERAL

##### 1.1 DESCRIPTION

- A. Provide subgrade preparation and the base material installation complete, including clearing, grading, excavation, filling and compaction and dewatering.
- B. Subgrade is that area on which concrete, aggregate base, or layer of any other non-organic material is to be placed.

##### 1.2 QUALITY ASSURANCE

- A. Reference Standards
  - 1. Perform all work in accordance with all applicable laws, codes and regulations required by the City of Brentwood, and County of Contra Costa.
  - 2. Perform work in accordance to applicable sections of the Caltrans Standard Specifications.
  - 3. Reference to "Caltrans Standard Specifications" shall mean the Standard Specifications of the State of California, Business and Transportation Agency, Department of Transportation, CALTRANS.
- B. Related work specified elsewhere includes:
  - 1. Section 31 2000, Earthwork
  - 2. Section 32 1216, Asphalt Concrete Paving
  - 3. Section 03 1313, Concrete
- C. Stipulations
  - 1. The finished surface of the subgrade, at any point, shall not vary more than 0.05' above or below the elevation indicated on the drawings.
  - 2. Finish Surface Tolerance: 1/4-inch maximum variation in 10 feet.
- D. ASTM Standards.

##### 1.3 SUBMITTALS

- A. Provisions: Comply with Division 1 Requirements.
- B. Material list and product data of all items proposed to be provided under this Section.
- C. Certificates (certified analysis of certificate of compliance) signed by the material producer.

#### 1.4 PROJECT CONDITIONS

- A. Coordination: Coordinate this work with the work of other Sections to avoid delay and interference with other work.

#### 1.5 SOILS REPORT:

- A. A soil investigation report has prepared for the project by the firm of BSK, entitled:
  1. Geotechnical Investigation Report and Geologic Hazard Assessment, Liberty High School Campus Expansions by BSK dated April 11, 2018.
- B. This report is available in the office of the Architect and the Construction Manager for inspection by the Contractor. Unless otherwise specified, it is intended that all work be performed in accordance with the provisions of these report.

#### 1.6 SOILS BORINGS

- A. Subsurface soils investigations have been made at the site and logs of the test holes are available with the soils report. Such investigations have been made for the purposes of design only, and neither the Architect, the Owner, nor the Soils Engineers guarantee adequacy or accuracy of the data, or that data are representative of all conditions to be encountered. Such information is made available for general information only and shall not relieve the Contractor of the responsibility for making his own investigations

#### 1.7 PROJECT CONDITIONS

- A. Coordination: Coordinate this work with the work of other Sections to avoid delay and interference with other work.



- B. Protect excavations by shoring, bracing, sheeting, underpinning, or other methods as required to prevent cave-ins or loose dirt from entering excavations. Barricade open excavations and post warning lights at work adjacent to public streets and walks.
- C. Underpin adjacent structure(s), including utility service lines, which may be damaged by excavation operations.
- D. Promptly repair damage to adjacent facilities caused by earthwork operations. Cost of repair at Contractor's expense.
- E. Promptly notify the Inspector of unexpected subsurface conditions.
- F. If during the course of operations, an area of pumping or otherwise unstable soil is encountered, the contractor shall immediately modify his operations in such a way as to limit the frequency and weight of vehicles traveling over the area and promptly notify the Inspector who will contact the Geotechnical Engineer for an evaluation.

#### **1.8 EXISTING CONDITIONS**

- A. A topographic survey of the property has been included in the drawings for reference only. Upon beginning the work, Contractor represents that he has inspected the site and satisfied himself as to actual grades and levels and the true conditions under which the work is to be performed.

#### **1.9 PROTECTION**

- A. Furnish, place and maintain all supports, shoring and sheet piling which may be disturbed by earthwork operations.
- B. Maintain all benchmarks, monuments, and other reference points. If disturbed or destroyed, replace as directed.
- C. Adequate protection measures shall be provided to protect workmen, passers-by, and the site. Streets and adjacent property shall be fully protected throughout the operations.
- D. In accordance with generally accepted construction practices, the Contractor shall be solely and completely responsible for working conditions on the job site, including safety of all persons and property during performance of the work. This requirement shall apply continuously and not be limited to normal working hours.
- E. Any construction review of the Contractor's performance conducted by the Inspector

is not intended to include review of the adequacy of the Contractor's safety measures in, on, or near the construction site.

- F. Adjacent streets, sidewalks, and property shall be kept free of mud, dirt, or similar nuisances resulting from earthwork operations.
- G. Provide for surface drainage during the period of construction in a manner to avoid creating a nuisance to adjacent areas.
- H. Water as required to suppress dust nuisance.
- I. Protection of Existing Improvements
  - 1. Provide barricades, covering, or other types of protection necessary to prevent damage to existing improvements indicated to remain in place. Protect improvements on adjoining properties. Repair damaged existing improvements to original condition as approved by authority having jurisdiction.
- J. Provide erosion control measures as required.
- K. Protection of Other Property: Excavation and other work over, under and adjacent to existing pipelines, cables, conduit runs or structures of any kind shall be procured in such a manner as not to interfere with the safe operation and use of such installations . Should any damage be incurred to existing facilities during the Contractor's operations, the Contractor shall immediately notify the Owner's Representative and authorities, and shall arrange for the immediate repair of same at his own expense.
- L. Underground Obstruction: The locations of existing underground utilities and structures, insofar as they are known from information furnished by the respective utility companies and agencies, have been shown on the drawings. The Owner assumes no responsibility for the accuracy or completeness of said data, which is offered solely for the convenience of the Contractor.
- M. Control of Water: Take measures as may be required and furnish, install and operate such pumps or other devices as may be necessary to remove any seepage, storm water or sewage that may be found or may accumulate in the excavations during the progress of the work. Keep excavations entirely free from water at all times during the construction of the work, and until the Geotechnical Engineer gives permission to cease pumping.
- N. Pavement Restoration: Pavement, bases and compacted subgrade disturbed by trenching operations shall be replaced in an acceptable manner with materials equal to the adjacent compacted subgrade, bases and pavement for a minimum distance of 12" on each side of the trench, and shall conform to the requirements of these

Specifications or to local ordinances governing such replacement.

#### **1.10 FIELD QUALITY CONTROL**

- A. Contractor shall provide adequate notice, cooperate with, provide access to the work, and assist testing agency and their representatives in execution of their function.
- B. When, during the progress of work, field tests indicate that installed compacted materials do not meet specified requirements, provide additional compaction until specified density is achieved, or remove and replace defective materials with new materials as directed by the Inspector. Cost of additional labor, materials, and testing to attain specified density at Contractor's expense.
- C. The Contractor shall engage a California Registered Civil Engineer or licensed Land Surveyor to perform field engineering.

#### **1.11 TESTING**

- A. Testing and Inspection: Testing shall be performed by a qualified independent testing laboratory under the supervision of a registered professional engineer, specializing in soils engineering.
- B. The Owner will direct, provide and pay for initial testing and inspection during operations .
- C. Provide and pay for re-testing and inspection during operations. Laboratory and inspection service shall be acceptable to the Owner.
- D. Where reference is made to relative compaction, it shall be the in-place dry density of soil expressed as a percentage of the maximum dry density of the same material, determined by the ASTM 01557 laboratory test procedure. Optimum moisture is the water content that corresponds to the maximum dry density.
- E. For structural fills under footings, slabs or pavements, determine moisture-density relationships in accordance with ASTM 01557.
- F. Plasticity Index: ASTM 4318-98.

#### **1.12 GENERAL REQUIREMENTS**

- A. When rain is forecast, temporary measures to protect areas of the exposed subgrade from saturation by rainfall or runoff shall be taken. These include, but are not limited

to, covering grading and sloping of subgrade surfaces to prevent ponding, sealing disturbed, uneven subgrade, surfaces with a smooth drum roller, grading and excavating diversionary swales, trenches or detention basins.

- B. Failure by the Contractor to comply with the above requirements to take reasonable and adequate measures or exercise sound engineering and construction practices to protect the work from damage. All repair work shall be performed at no additional cost to the Owner.

## **PART 2 - MATERIALS**

### **2.1 AGGREGATE BASE - CLASS 2**

- A. Aggregate base shall be Class 2, and free from vegetable matter or other deleterious substances. The percentage composition by weight of aggregate base shall conform to Section 26 of the Caltrans Standard Specifications.

### **2.2 RECYCLED AGGREGATE BASE - CLASS 2**

- A. Subject to the approval of the Geotechnical Engineer, recycled aggregate base shall be Class 2, and free from vegetable matter or other deleterious substances. The percentage composition by weight of aggregate base shall conform to Section 26 of the Caltrans Standard Specifications.
- B. Recycled aggregate compliant with the above provisions is acceptable for on-site work only. In accordance with City of Brentwood prohibitions, no recycled aggregate shall be used for off-site work in the public right-of-way.

## **PART 3 - EXECUTION**

### **3.1 SUBGRADE PREPARATION**

- A. Remove topsoil, stumps, roots, grasses and weeds to the satisfaction of the Geotechnical Engineer.
- B. Scarify subgrade to a depth specified in the geotechnical report.
- C. Remove all boulders, hardened material or rock encountered that is over 3 inches in

- size. The earth shall be uniform for the full depth and width of the subgrade.
- D. Lime treat the subgrade 12" deep per the Geotechnical Engineer's recommendations. Refer to the geotechnical report.
  - E. The proper moisture condition and compaction per the geotechnical report.
  - F. Relative compaction, maximum dry density, and optimum moisture content of fill materials shall be determined in accordance with ASTM Test Method D1557, "Moisture-Density Relations of Soils and Soil Aggregate Mixtures Using a 10-lb. Rammer and 18-in. Drop.
  - G. The finished subgrade surface shall be firm and unyielding under the weight of a loaded water truck traveling over the surface.

### **3.2 AGGREGATE BASE**

- A. Deliver to site as a uniform mixture and spread each layer in one operation without segregation.
  - 1. Class 2 Aggregate Base shall be readily compacted and spread with equipment that will provide a uniform layer conforming to the planned section, and as specified in Section 26 of the Caltrans Standard Specifications.
- B. The aggregate base shall be compacted to at least 95 percent relative compaction.
  - 1. Proof roll and mark "soft spots" for additional compaction or correction. Proof rolling operations must be performed in the presence of a Geotechnical Engineer.
- C. Unsatisfactory material shall be removed and repaired to the satisfaction of the Geotechnical Engineer.

**END OF SECTION**

## SECTION 31 2333

### TRENCHING AND BACKFILL

#### **1. GENERAL**

##### **1.1. RELATED DOCUMENTS**

- A. Drawings and general provisions of the Contract, including General and Supplementary Conditions and Division 1 Specification Sections, apply to this Section.

##### **1.2. SUMMARY**

- B. Section includes:
  - 1. Excavating and backfilling for utility trenches.
- C. Related Sections include:
  - 1. Section 31 2000 "Earthwork" for
    - (a) Preparing subgrades for slabs-on-grade, walks, pavements, lawns, and grasses, and exterior plants.
    - (b) Excavating and backfilling for buildings and structures.
  - 2. Section 22 1100 "Site Water Distribution" for underground water lines outside of buildings.
  - 3. Section 22 3100 "Site Sanitary Sewer" for underground sewer lines outside of buildings.
  - 4. Section 33 4000 "Site Storm Drainage" for underground storm drain lines.
  - 5. Division 26 Section for underground electrical conduits.

##### **1.3. DEFINITIONS**

- A. Backfill: Soil material or controlled low-strength material used to fill an excavation.
  - 1. Initial Backfill: Backfill placed beside and over pipe in a trench, including haunches to support sides of pipe.
  - 2. Final Backfill: Backfill placed over initial backfill to fill a trench.
- B. Base Course: Course placed between the subgrade and surface pavement in a paving system.
- C. Bedding Course: Course placed over the excavated subgrade in a trench before laying pipe and initial backfill over pipe and conduit.
- D. Borrow Soil: Satisfactory soil imported from off-site for use as fill or backfill.
- E. Excavation: Removal of material encountered above subgrade elevations and to lines and dimensions indicated.

1. Authorized Additional Excavation: Excavation below subgrade elevations or beyond indicated lines and dimensions as directed by Architect. Authorized additional excavation and replacement material will be paid for according to Contract provisions for changes in the Work.
  2. Unauthorized Excavation: Excavation below subgrade elevations or beyond indicated lines and dimensions without direction by Architect. Unauthorized excavation, as well as remedial work directed by Architect, shall be without additional compensation.
- F. Structures: Buildings, footings, foundations, retaining walls, slabs, tanks, curbs, mechanical and electrical appurtenances, or other man-made stationary features constructed above or below the ground surface.
- G. Subgrade: Surface or elevation remaining after completing excavation, or top surface of a fill or backfill immediately below base course, drainage course, or topsoil materials.
- H. Utilities: On-site underground pipes, conduits, ducts, and cables, as well as underground services within buildings.

#### 1.4. SUBMITTALS

- A. Product Data: For the following:
1. Each type of plastic warning tape.
- B. Soil Samples: As required by Owner's Geotechnical Engineer for sampling and testing of proposed offsite borrow soil material.
1. Deliver a representative sample of each type of imported borrow material to Owner's geotechnical testing agency's laboratory at least 7 days prior to delivery to site, for evaluation and testing.
- C. Material Test Report: From a qualified testing agency indicating and interpreting test results for compliance of the following with requirements indicated:
1. Classification according to ASTM D 2487 of each on-site and borrow soil material proposed for fill and backfill.
  2. Laboratory compaction curve according to ASTM D 1557 for each on-site and borrow soil material proposed for fill and backfill.

#### 1.5. QUALITY ASSURANCE

- A. Geotechnical Testing and Inspection: Owner will employ and pay for a qualified independent geotechnical testing and inspection agency to perform soils testing and inspection services during utility trenching and backfill operations. All imported borrow materials must be approved by Owner's geotechnical testing agency.

1.6. **PROJECT CONDITIONS**

- A. Site Information: Data in subsurface investigation reports was used for the basis of the design and is available to Contractor for information, only. Conditions are not intended as representations or warranties of accuracy or continuity between soil borings.
- B. Existing Utilities: Locate existing underground utilities in areas of excavation work. If utilities are indicated to remain in place, provide adequate means of support and protection during earthwork operations.
  - 1. Should uncharted or incorrectly charted piping or other utilities be encountered during excavation, consult utility owner immediately for directions. Cooperate with Owner and utility companies in keeping respective services and facilities in operation, if required. Repair damaged utilities to satisfaction of utility owner.
  - 2. Do not interrupt existing utilities serving facilities occupied by Owner or others unless permitted under the following conditions and then only after arranging to provide temporary utility services according to requirements indicated:
    - (a) Notify Architect not less than five working days in advance of proposed utility interruptions.
    - (b) Do not proceed with utility interruptions without Architect's written permission.
  - 3. Demolish and completely remove from site existing underground utilities identified for removal. Coordinate with utility companies for shutoff of services if lines are active.
- C. Use of explosives is not permitted.
- D. Protection of Persons and Property:
  - 1. Barricade open excavations and post with warning lights as per requirements of authorities having jurisdiction.
    - (a) Conform to all applicable occupational safety regulations.
  - 2. Protect structures, utilities, sidewalks, pavements, and other facilities from damage caused by settlement, lateral movement, undermining, washout, and other hazards created by earthwork operations.
  - 3. Excavation within drip line of trees to remain to be performed by hand. Protect root systems from damage or dry out to the greatest extent possible. Maintain moist condition for root system and cover exposed roots with moistened burlap. Refer to Section 02235 "Tree Protection and Trimming" for additional requirements.
- E. Dust Control: Conduct earthwork operations so as to prevent windblown dust and dirt from interfering with Owner's and adjacent property owners' normal operations.



## **2. PRODUCTS**

### **2.2 SOIL MATERIALS**

- A. General: Provide borrow soil materials when sufficient satisfactory soil materials are not available from excavations.
- B. Satisfactory Soils: As specified in Section 02300 "Site Earthwork," and free of debris, waste, frozen materials, vegetation, and other deleterious matter.
  - 1. Onsite native soils below the stripped layer having an organic content of less than 3 percent by weight are suitable for use as backfill at utility trenches.
- C. Bedding Course: Naturally or artificially graded mixture of natural or crushed gravel, crushed stone, and natural or crushed sand; ASTM D 2940; except with 100 percent passing a 1-inch sieve and not more than 8 percent passing a No. 200 sieve.

### **2.2 MISCELLANEOUS MATERIALS**

- A. Concrete: Normal-weight concrete with not less than 3,000-psi compressive strength (28 days), 3-inch slump. Measure, batch, and mix according to ASTM C 94.
  - 1. Portland Cement: ASTM C 150, Type I or II.
  - 2. Aggregate: ASTM C 33; 1-inch maximum size.
  - 3. Water: ASTM C 94; potable.

### **2.3 ACCESSORIES**

- A. Detectable Warning Tape: Acid-resistant and alkali-resistant polyethylene film warning tape manufactured for marking and identifying underground utilities, a minimum of 6 inches wide and 4 mils thick, continuously inscribed with a description of the utility, with metallic core encased in a protective jacket for corrosion protection, detectable by metal detector when tape is buried up to 30 inches deep; colored as follows:
  - 1. Red: Electric.
  - 2. Yellow: Gas, oil, steam, and dangerous materials.
  - 3. Orange: Telephone and other communications.
  - 4. Blue: Water systems.
  - 5. Green: Storm and sewer systems.

### **3. EXECUTION**

#### **3.1. PREPARATION**

- A. Protect structures, utilities, sidewalks, pavements, and other facilities from damage caused by settlement, lateral movement, undermining, washout, and other hazards created by earthwork operations.
- B. Provide erosion-control measures to prevent erosion or displacement of soils and discharge of soil-bearing water runoff or airborne dust to adjacent properties and walkways.

#### **3.2. DEWATERING**

- A. Prevent surface water and ground water from entering excavations, from ponding on prepared subgrades, and from flooding Project site and surrounding area.
- B. Protect subgrades from softening, undermining, washout, and damage caused by rain or water accumulation.

#### **3.3. EXCAVATION, GENERAL**

- A. Do not use explosives.
- B. Unclassified Excavation: Excavation is unclassified and includes excavation to required subgrade elevations regardless of the character of materials and obstructions encountered.
- C. Stability of Excavations:
  - 1. Comply with all applicable local codes, ordinances, and requirements of authorities having jurisdiction to maintain stable excavations. Maintaining stability of excavations is sole responsibility of Contractor.
    - (a) Support all trench and other excavations in accordance with California Code of Regulations, Title 8 -Industrial Relations (Cal/OSHA Standards), Chapter 4 - Division of Industrial Safety, Subchapter 4 – Construction Safety Orders.

#### **3.4. EXCAVATIONS FOR UTILITY TRENCHES**

- A. Excavate trenches to indicated gradients, lines, depths, and elevations.
  - 1. Beyond building perimeter, excavate trenches to allow installation of top of pipe below frost line.
  - 2. Where trench runs parallel to perimeter edge of adjacent structure, do not locate trench excavations within distance to structure, such that any portion of structure, including footings, will occur above a plane projected upward at a slope of one vertical to two horizontal from any point in the excavation.

- B. Excavate trenches to uniform widths to provide the following clearance on each side of pipe or conduit. Excavate trench walls vertically from trench bottom to 12 inches higher than top of pipe or conduit, unless otherwise indicated.
  - 1. Clearance: 12 inches each side of pipe or conduit, or as otherwise indicated.
- C. Trench Bottoms: Excavate trenches 6 inches deeper than bottom of pipe elevation to allow for bedding course. Hand excavate for bell of pipe.

**3.5. SUBGRADE INSPECTION**

- A. Notify Architect and Geotechnical Engineer when excavations have reached required subgrade.
- B. If Geotechnical Engineer determines that unsatisfactory soil is present, continue excavation and replace with compacted backfill or fill material as directed.
- C. Reconstruct subgrades damaged by freezing temperatures, frost, rain, accumulated water, or construction activities, as directed by Architect and Geotechnical Engineer, without additional compensation.

**3.6. STORAGE OF SOIL MATERIALS**

- A. Stockpile borrow soil materials and excavated satisfactory soil materials without intermixing. Place, grade, and shape stockpiles to drain surface water. Cover to prevent windblown dust and saturation from rain.
  - 1. Stockpile soil materials away from edge of excavations. Do not store within drip line of remaining trees.
  - 2. Dispose of excess excavated soil material and materials not acceptable for use as backfill or fill. Comply with all applicable state and local requirements for offsite disposal of soil and other waste materials.

**3.7. UTILITY TRENCH BACKFILL**

- A. Place and compact backfill in excavations promptly, but not before completing the following:
  - 1. Surveying locations of underground utilities for Record Documents.
  - 2. Testing, inspecting, and approval of underground utilities.
  - 3. Removal of trash and debris from excavation.
  - 4. Removal of temporary shoring and bracing, and sheeting.
- B. Place bedding and backfill material on subgrades free of mud, frost, snow, and ice. Remove vegetation, topsoil, debris, wet and unsatisfactory soil materials, obstructions, and deleterious materials from ground surface prior to placing backfill materials.

- C. Place and compact bedding course 6 inches in depth on trench bottoms. Shape bedding course to provide continuous support for bells, joints, and barrels of pipes and for joints, fittings, and bodies of conduits.
  - 1. Prevent displacement of piping or conduit by placing and compacting material uniformly around piping or conduit to approximately same elevation in each lift.
  - 2. Place bedding material to an elevation of 12 inches above top of pipe or conduit.
- D. Use satisfactory soil material for trench backfill.
- E. Trenches Under Footings: Where trenches pass under footings or are excavated within 18 inches of footings, fill to elevation of bottom of footings with concrete.
- F. Placement and Compaction of Bedding and Backfill Material: Place to final subgrade elevation.
  - 1. Place backfill materials in layers not more than 8 inches in loose depth.
  - 2. Soil Moisture Control: Uniformly moisten or aerate subgrade and each subsequent backfill soil layer before compaction to levels indicated.
  - 3. Compact each layer of bedding material and backfill soil material at 95 percent relative compaction at a moisture content of 3 to 5 percent above laboratory optimum value, according to ASTM D 1557, except as follows:
    - (a) Where occurring within turf or planted areas, compact upper 18 inches of backfill soil material at 85 percent relative compaction at a moisture content of 3 to 5 percent above laboratory optimum value.
  - 4. Correct improperly compacted areas or lifts as directed by Architect or Geotechnical Engineer if soil density tests indicate inadequate compaction.
- G. Install warning tape directly above utilities, 12 inches below finished grade, except 6 inches below subgrade under pavements and slabs.

3.8. **PAVEMENT BASE COURSES**

- A. Place base courses under paved areas on prepared subgrade, in indicated thicknesses, or if not indicated, to match thickness of existing base course, and as specified in Section 02740 "Asphalt Concrete Paving."

3.9. **FIELD QUALITY CONTROL**

- A. Testing Agency: Owner will engage a qualified independent geotechnical engineering testing agency to perform field quality-control testing.
  - 1. Notify Owner's testing agency at least 2 working days prior to date when observation and testing services are needed.

- B. Allow testing agency to inspect and test subgrades and each fill or backfill layer. Proceed with subsequent earthwork only after test results for previously completed work comply with requirements.
- C. Testing agency will test compaction of soils in place according to ASTM D 1556, ASTM D 2167, ASTM D 2922, and ASTM D 2937, as applicable. Tests will be performed at the following locations and frequencies:
  - 1. Trench Backfill: At each compacted initial and final backfill layer, at least one test for each 150 feet or less of trench length, at a frequency of no less than 18 inches vertically, but no fewer than two tests.
- D. When testing agency reports that subgrades, fills, or backfills have not achieved degree of compaction specified, scarify and moisten or aerate, or remove and replace soil to depth required; recompact and retest until specified compaction is obtained.
  - 1. Additional testing and inspection required by failure to meet specified requirements will be at Contractor's expense.

3.10. **PROTECTION**

- A. Where settling occurs before Project correction period elapses, remove finished surfacing, backfill with additional soil material, compact, and reconstruct surfacing.
  - 1. Restore appearance, quality, and condition of finished surfacing to match adjacent work, and eliminate evidence of restoration to greatest extent possible.

3.11. **DISPOSAL OF SURPLUS AND WASTE MATERIALS**

- A. Disposal: Remove surplus satisfactory soil and waste material, including unsatisfactory soil, trash, debris, and legally dispose of it off Owner's property.

**END OF SECTION 31 2333**

## SECTION 32 1216

### ASPHALT CONCRETE PAVING

#### PART 1 - GENERAL

##### 1.1 RELATED DOCUMENTS

- A. Drawings and general provisions of the Contract, including General and Supplementary Conditions and Division 1 Specification Sections, apply to this Section.

##### 1.2 SUMMARY

- A. Work Included: Furnish all labor, materials, equipment, facilities, transportation and services to complete all asphaltic concrete paving operations including the preparation and paving of new areas, paving overlays, patch paving of all existing paved areas disturbed by construction and related work as shown on the drawings and/or specified herein.
- B. Related Sections include:
  - 1. Section 31 2000: Earthwork
  - 2. Section 31 2333: Trenching and Backfilling
- C. References:
  - 1. Sections and chapters of Standard Specifications mentioned herein refer to Standard Specifications, State of Californian, Department of Public Works, Division of Highways, Latest Edition.

##### 1.3 SUBMITTALS

- A. Provide owner with complete materials listing for approval. Materials certificates shall be signed by the material producer and the Contractor, certifying that each material item complies with or exceeds specified requirements.

##### 1.4 DELIVERY, STORAGE, AND HANDLING

- A. Comply with pertinent provisions of Section , Material, Equipment and Substitutions.
- B. Engineering fabrics shall be furnished in protective covers capable of protecting the fabric from ultraviolet rays, abrasion, and water.

##### 1.5 PROJECT CONDITIONS

- A. Weather Limitations

1. Do not lay base course on muddy subgrade, during wet weather, or when atmospheric temperature is below 35 degrees Fahrenheit.
  2. Do not apply asphaltic surfacing on wet base, during hot weather, or when atmosphere temperature is below 40 degrees Fahrenheit
- B. Grade Controls
1. Establish and maintain required lines and grades, including crown and cross slope.

## **1.6 PERFORMANCE REQUIREMENTS**

- A. Qualifications of asphalt concrete producer: Use materials that are furnished by bulk asphalt concrete producers regularly engaged in production of hot-mix, hot-laid asphalt concrete.
- B. Applicator qualification: Company specializing in the application of asphalt concrete paving.
- C. Asphalt concrete paving shall show no evidence of cracking, uneven settlement or improper drainage. Contractor will be responsible for correcting work displaying such conditions.
- D. Allowable tolerances: Finish surface shall be true to established elevations with 1/8" in ten feet as measured from a 10-foot straight edge in any direction.

## **PART 2 - PRODUCTS**

### **2.1 STANDARDS**

- A. Reference State of California design methods of flexible pavements.

### **2.2 MATERIALS**

- A. Aggregate Base: Aggregate base material and method of placing shall conform to Section 26 of the State Specifications excepting modifications as herein specified. The aggregate base shall conform to the grading providing for 3/4 inch maximum grading as shown herein.

Percentage Passing

<u>Sieve Size</u>	<u>Sieve By Weight</u>
	3/4" Max.
2"	100
1-1/2"	100
3/4"	90-100
No. 4	35-55
No. 30	10-30
No. 200	2-9

- B. Asphaltic Concrete: Shall be Type "B" in conformance to Sections 39 and 92 of the State of California Specifications, except as herein modified:
  - 1. Aggregate for Asphaltic Concrete: Shall be a ½ inch maximum gradation for new pavement areas, medium grade.
- C. Asphalt Emulsion: Shall conform to Section 94 of the State Specifications.
- D. Redwood Header: All headerboards shall be two (2) inch by eight (8) inch. The headerboards shall be held in place with two (2) inch by six (6) inch by twenty-four (24) inch, or long enough to extend 12 inches into solid ground, whichever is greater.

### **PART 3 - EXECUTION**

#### **3.1 PLACEMENT OF AGGREGATE BASE**

- A. The Contractor shall proof roll subbase prior to placement of aggregate base. If soft areas are encountered, the Contractor shall excavate backfill with aggregate base or suitable material and compact to 95%. The Contractor shall remove any loose material or debris. Prior to correction of any soft areas identified by proof rolling, a Change Order must be authorized by the Owner.
- B. Aggregate Base Method of Placing: The Contractor shall conform to Section 26 of the State Specifications excepting modification as herein specified.
- C. Aggregate Base shall be placed in 6" maximum lifts and each lift will be compacted to 95% relative compaction.
- D. The material will be deposited on the subgrade in such a manner as to provide a uniform section of material within five percent tolerance of the pre-determined required depth. Deposition will be by spreader box or bottom dump truck to prevent segregation of the



material. The material so deposited on the subgrade shall have sufficient moisture, which in the opinion of the Soils Engineer, is adequate to prevent excessive segregation. It shall then be immediately spread to its planned grade and cross section. Undue segregation of material, excessive drifting or spotting of material will not be permitted and any material, in the opinion of the City and Owner, to be unsuitably segregated, shall be removed from the subgrade or completely reworked to provide the desired uniformity of the material.

**3.2 PLACEMENT OF FRAMES, COVERS AND GRATES**

- A. The Contractor shall set and adjust to finish grade all new and existing frames, covers, and grates of all manholes, drop inlets, drain boxes, valves, cleanouts, electrical boxes and other appurtenant structures prior to placement of asphaltic concrete.

**3.3 ASPHALT CONCRETE**

- A. The Asphalt Concrete method of placing shall conform to Sections 39 and 92 of the State Specifications, except as herein modified.
- B. Prior written approval of the City is required before the Contractor may place asphalt concrete without the use of paving machine. After compaction, the asphalt concrete shall have a density of not less than 95 percent (95%) of the maximum theoretical unit weight, as determined in the laboratory by Test Method No. Calif. 304.

**3.4 ASPHALT EMULSION**

- A. Asphalt Emulsion method of placing shall conform to Sections 37, 39 and 94 of the State Specifications.

**3.5 REDWOOD HEADER**

- A. Stakes shall be of sound material, neatly pointed, driven vertically, located at butt joints and elsewhere, spaced not over 4 feet on center and securely nailed to the headerboards. Headerboards shall have a continuous beading on undisturbed earth or compacted earth or base rock.
- B. The top edges of the headerboard shall conform to the line and grade of the pavement.

**END OF SECTION 32 1216**

## SECTION 32 1313

### CONCRETE PAVING

#### PART 1 - GENERAL

##### 1.1 DESCRIPTION

A. Provide Portland cement concrete site work complete. including the following principal items:

1. Concrete work shown on Landscape Drawings.

B. Related requirements include:

1. Section 31 2000, Earthwork
2. Section 31 2313, Subgrade Preparation and Base Material
3. Section 32 1216, Asphalt Concrete Paving

##### 1.2 QUALITY ASSURANCE

A. Reference and Standards

1. Perform work in accordance with all applicable laws, codes and regulations required by City of Brentwood and County of Contra Costa and the State of California.
2. Reference to "Standard Specifications" shall mean the current Standard Specifications of the State of California, Business and Transportation Agency, Department of Transportation, CALTRANS.
3. The American Concrete Institute (ACI): "Manual of Concrete Practice," Parts 1, 2 and 3.

B. Stipulations

1. Finish Surface Tolerance: 1/4-inch maximum variation in 10 feet.

##### 1.3 TESTS

A. The Project Inspector will select a qualified testing laboratory to take samples for testing during the course of the work as considered necessary. The Owner will pay costs for such tests. Contractor shall cooperate in making tests and shall be responsible for notifying the designated laboratory in sufficient time to allow taking of samples at time of pour.

B. Should tests show that concrete is below specified strength, Contractor shall remove all such concrete, as directed by the Project Inspector. Full cost of removal of low strength concrete, its replacement with concrete of proper specified strength and testing, shall be borne by Contractor.

#### **1.4 COORDINATION**

- A. Coordinate items of other trades. Contractor shall be responsible for the proper installation of all accessories embedded in the concrete and for the provision of holes, openings, etc., necessary to the execution of the work of the trades.

#### **1.5 SOILS REPORT:**

- A. A soil investigation report has prepared for the project by the firm of BSK, entitled:
  - 1. Geotechnical Investigation Report and Geologic Hazard Assessment, Liberty High School Campus Expansions by BSK dated April 11, 2018.
- B. This report is available in the office of the Landscape Architect and the Construction Manager for inspection by the Contractor. Unless otherwise specified, it is intended that all work be performed in accordance with the provisions of these report.

#### **1.6 SOILS BORINGS**

- A. Subsurface soils investigations have been made at the site and logs of the test holes are available with the soils report. Such investigations have been made for the purposes of design only, and neither the Landscape Architect, the Owner, nor the Soils Engineers guarantee adequacy or accuracy of the data, or that data are representative of all conditions to be encountered. Such information is made available for general information only and shall not relieve the Contractor of the responsibility for making his own investigations

#### **1.7 SUBMITTALS**

- A. Submittals per Division 1 requirements
- B. The Contractor's Testing Laboratory's certificate of compliance.
- C. The Contractor shall submit:
  - 1. Certified copies of mix designs for each concrete class specified including compressive strength test reports.
  - 2. Certification that materials meet requirements specified.
  - 3. Certification from vendor that samples originate from and are representative of each lot proposed for use.
- D. Mock-ups of all materials under this Division shall be supplied for testing as requested by the Architect
- E. Provide mockup of all concrete finishes, color and joints (with curing compound if any to be used) indicated on the drawings. Accepted mock-ups shall be kept at the job site to serve as a prerequisite for all finishes.

## 1.8 PRODUCT DELIVERY, STORAGE AND HANDLING

- A. Supply ready mixed concrete throughout. Batch mix and transport in accordance with ASTM C-94, "Specifications for Ready Mixed Concrete."
- B. Mix and deliver concrete in quantities that will permit immediate use only.
- C. Indiscriminate addition of water for any reason will be cause for rejection of the load. 2.

## PART 2 - PRODUCTS

### 2.1 FORMWORK MATERIALS

- A. Forms shall be wood.
  - 1. Plywood: APA Plyform, Grade B-B, 5/8-inch thickness minimum.
  - 2. Lumber: Douglas fir, "Standard" grade or better (grade marks not required).
  - 3. Plywood: 5/8-inch thickness minimum. Use overlaid plywood complying with U.S. Product Standard PS-1 "A-C or B-B High Density Overlaid Concrete Form", Class 1. Panels to receive specified form sealer to ensure uniform finish of exposed surfaces
- B. Form Coatings: Knox-Crete, or equal.
- C. Form Ties: Burke "Penta-Tie," or equal, cone and rod type with 1-inch break-back. Do not use form ties on exposed concrete of seat walls.

### 2.2 REINFORCING MATERIALS

- A. Bar Reinforcement ASTM A615.
  - 1. #3 and smaller: Grade 40.
  - 2. #4 and larger: Grade 60.

### 2.3 CONCRETE MATERIALS

- A. Portland Cement: ASTM C150, Type II.
- B. Aggregate: ASTM C33.
  - 1. Coarse Aggregate: Normal weight; 3/4-inch maximum size; clean, uncoated, crushed aggregate, free of materials which cause staining or rust spots.
  - 2. Fine Aggregate: Clean, natural sand.
- C. Water: Clear and potable, free from deleterious impurities.
- D. Admixtures: Admixtures are optional, must be compatible with color pigments where required. Any proposed admixture shall comply with State Section 2603(b) 5 of Part 2, Title 24 CCR. Accelerating admixtures are not permitted.

## 2.4 CONCRETE MIXES

- A. Concrete mixes shall be accepted and shall be in accordance with CalTrans Standard Specifications Section 90. Unless otherwise noted, mix shall be Class "A," 3,000 psi, Type II Portland cement and 3/4- inch maximum aggregate.
- B. Lamp Black: Concrete for exposed "natural colored" concrete shall be darkened by the addition of accepted agents at the mixer. The proportion of lampblack or other accepted colorant, to a great extent dependent on the color of the cement used in the mix, shall be that required to properly darken the concrete to reduce glare, and shall be subject to the approval of the Project Inspector or as required by Landscape Architect. Provide mock-ups with a ratio of one pound of lamp black for each cubic yard of concrete or as otherwise approved.

## 2.5 ANCILLARY MATERIALS

- A. Expansion Joint Material
  - 1. Fiber Expansion Joint: A non-extruding resilient filler, saturated with high quality bituminous materials having preserving characteristics. W. R. Meadows or accepted equal. Conform to ASTM- 01751-83. Include Joint Sealant
- B. Curing Compound: ASTM C309, Water-base type, free of permanent color, oil or wax, or accepted equal. Curing compound shall be compatible with color pigments.
- C. Concrete Sealer: As manufactured by L. M. Scofield Co. or silicone-based, non-staining product such as Siloxane as manufactured by Prosoco and available from White Cap (415) 626-3750 and as accepted by Architect. Concrete Sealer shall be compatible with color pigments.
- D. Combination Curing Compound Concrete Sealer: W. R. Meadows Vocomp-20, (800-342-5976) or accepted equal. Combination Curing Compound. Combination Curing Compound Concrete Sealer shall be compatible with color pigments.
- E. Joint Sealant: W. R. Meadows or Sonnebom 2-part joint sealant or Sikaflex-1a elastomeric joint sealant or equal product. Available from Sika Corporation, Hayward (510) 487-2294. Color shall be as selected by Landscape Architect.
- F. Color of Concrete: Pigments for integral colored concrete as manufactured by Davis Colors, 800-356- 4848, applied at manufacturer's specified rates of application, or accepted equal

## 2.6 WATERPROOFING

- A. Subseal-60 Self-adhering Waterproofing Membrane available from MFM Building Products Corp or accepted equal.

## 2.7 TRUNCATED DOMES

- A. Detectable dome spacing and size to meet detail on Civil Drawings.

- B. Detectable warning devices to be color yellow conforming to Federal color number 33538.
- C. When placed on asphalt, adhesive type detectable warning surface may be installed in lieu of cast-in concrete.

### **PART 3 - EXECUTION**

#### **3.1 GENERAL REQUIREMENTS**

- A. Install all concrete work true to line and grade as indicated on the drawings.
- B. Correct irregularities to the satisfaction of the Project Inspector.

#### **3.2 PREPARATION**

- A. Take every precaution to obtain a subgrade of uniform bearing power by compaction to provide a firm base.
- B. Subgrade shall be kept moist and shall not be allowed to dry out before placement of concrete. Place no material on muddy subgrade.
- C. Aggregate base, where indicated, shall be placed and compacted in conformance with CalTrans Standard Specifications 26-1.04 and 26-1 .05.
- D. Obtain acceptance of subgrade from Project Inspector prior to placing steel and concrete.

#### **3.3 FORMS**

- A. Forms shall be constructed in accordance with ACI 347 and shall be of sufficient strength and sufficiently tight to prevent visible distortion or leakage of mortar and fines.
- B. Forms for exposed surfaces shall be designed to protect intended finish. Deflection of facing material between studs shall not exceed 0.0025 of the span. Facing material and pattern of joints shall be as accepted by the Architect.
- C. For vertical surface of wall footings below grade, clean-cut trench may be used in lieu of form if character of soil will permit installation without sluffing and width of concrete is increased at least 1 inch beyond indicated dimension of each face poured against earth.
- D. Curb and pavement edge forms shall extend full depth of concrete. Curves shall be formed with flexible metal or wood made up of thin laminations. Curve forms shall extend one stake space straight beyond tangent point.
- E. Maintain forms within the following tolerances.
  - 1. Top of Form: Plus or minus 1/8 inch in 10 feet and no abrupt variations; at required elevation to plus 3/8 inch.
  - 2. Face of Form: Plus or minus 1/4 inch in 10 feet longitudinal and no abrupt variations; perpendicular to surface plus or minus 1/8 inch.
- F. Obtain approval of formwork from Project Inspector prior to placing concrete.

Forms may be reused upon cleaning and coating with parting compound to ensure separation from concrete without damage.

After concrete is placed, the following minimum times shall elapse before removal of forms.

1. Footing sides: 24 hours.
2. Mow bands, curbs and pads: 48 hours.

### **3.4 REINFORCEMENT**

- A. All concrete shall be steel reinforced unless specifically noted to be "not reinforced." If no reinforcement is shown, reinforce in same manner as that shown in similar places.
- B. Fabricate and place reinforcement as indicated on the Drawings and in accordance with ACI "Detailing Manual" SP-66. No reinforcement shall be placed prior to distribution of the accepted shop drawings.
- C. Secure reinforcement in position by suitable supports and by wiring at intersections with tie wire. Supports shall be of sufficient number and strength to resist crushing or displacement under full load. Metal shall not extend to surface of concrete.
- D. At time of placing concrete, reinforcing shall be free of excessive rust, mill scale, or other bond reducing matter. Immediately before placing concrete, check and adjust position, support and anchorage.

### **3.5 MIXING AND PLACING CONCRETE**

- A. Conform to applicable requirements set forth in CalTrans Standard Specifications Section 90.

### **3.6 JOINTS AND GROOVES**

- A. Plane of joints shall be perpendicular to surface. Where new pavements join existing, joints shall align.
- B. Install joint sealant at fiber expansion joints per manufacturer's specifications.
- C. Construction Joints: Place construction joints at the end of pours and at locations where placement operations are stopped for a period of more than one half hour, except where such pours terminate at expansion joints.
  1. Construction joints shall be keyed with formed tongue and groove.
  2. Tool concrete edge both sides of construction joint.
- D. Saw Cut Joints: Begin as soon as concrete has hardened enough to support saw and operator, and to allow cutting without raveling, or deforming the surface finish. Use a concrete cutting blade. Form a smooth uniform joint 1/8" wide, to 1" depth unless shown otherwise. Joints shall be cut within 48 hours of pour. Hold saw cuts 1/2" from edge of concrete.

- E. Score Joints: Form in the fresh concrete using a jointer to cut the groove so that a smooth uniform impression is obtained to 1" depth unless shown otherwise. All joints shall be struck before and after brooming. Tool concrete both sides of joint.
- F. Expansion Joints and Edging: Provided at the location and intervals as shown on the drawings, and at all locations where concrete paving abuts buildings, curbs or other structures, and not greater than 20 feet on center. Approved joint material shall be placed with top edge below the paved surface and shall be securely held in place to prevent movement. Joint and other edges shall be formed in the fresh concrete using an edging tool to provide a smooth uniform impression. All edges shall be struck before and after brooming.

### 3.7 FINISHING

- A. Mow bands, paving and other exposed work.

#### 1. Surface Finishes

- a. Float Finish (typical preliminary finishing for slabs to receive other finishes): The surface of the slab shall be screeded and all surface water and laitance removed. Floating shall be started as soon as the screeded surface has stiffened sufficiently. Floating shall be performed by hand using a wood float and shall be the minimum necessary to produce a relatively smooth, level, even-textured surface.
- b. Medium Broom Finish: After the slab has been float finished as described above, the surface shall be uniformly directional textured by coarse stable broom to match accepted mock up to be a non-slip finish.
- c. Sandblast Finish: Perform in as continuous an operation as possible, utilizing the same work crew to maintain continuity of finish to match accepted mock up. Use abrasive grit of the proper type and gradation to expose the aggregate and surrounding matrix surfaces to match mock up panel, as follows:
  - 1) Medium Cut: Approximately 1/8" to 3/16" depth.
  - 2) Heavy cut: Approximately 1/2" to 3/4" depth.
  - 3) Blast corners and edge of patterns carefully, using backup boards in order to maintain a uniform corner of edge line.
  - 4) Use same nozzle, nozzle pressure and blasting technique as used for mock up panel.
  - 5) Maintain control of abrasive grit and concrete dust in each area of blasting. Clean up and remove all expended abrasive grit, concrete dust and debris at the end of each day of blasting operations.

### 3.8 DEFECTIVE CONCRETE

- A. If any concrete work is not formed as indicated, is under strength concrete, if concrete is out of line, level or plumb, or showing objectionable cracks, honeycomb, rock pockets, voids, spelling or exposed reinforcing, it shall be removed, repaired or replaced as directed by the Landscape Architect.

### 3.9 CURING

- A. Cure exposed concrete in accordance with CalTrans Standard Specifications Section 90.



- B. Only water or curing compounds that impart no permanent color or gloss shall be used for curing concrete.

### **3.10 CONCRETE SEALING**

- A. Seal all exposed surfaces according to manufacturer's specifications.

### **3.11 WATERPROOFING**

- A. Where soil is backfilled against seat walls install waterproofing per manufacturer's specifications. Hold 2" below finish grade.
- B. During construction, wash off work as quickly as possible when stains or splotches are unavoidable.

### **3.12 TRUNCATED DOMES**

- A. Detectable warning surface shall be recessed and cast in concrete.

### **3.13 CLEANUP:** Per Division 1 requirements.

- A. Upon completion, clean exposed surfaces carefully. Brushing and cleaning solution, if used, must be preceded and followed with a through rinsing of clear water. No sandblasting will be allowed to clean surfaces.
- B. Remove from premises; equipment, debris and surplus material needed for, or resulting from, this work. Remove all concrete waste from planting areas and legally dispose of it.
- C. All work shall be left in a condition satisfactory to the Landscape Architect.

**END OF SECTION 32 1313**

## SECTION 32 1723

### PAVEMENT MARKINGS

#### PART 1 - GENERAL

##### 1.1 SECTION INCLUDES

- A. Provide pavement striping and symbols complete.
- B. Related work specified elsewhere includes:
  - 1. Section 32 1313 Concrete Paving
  - 2. Section 32 1216, Asphalt Concrete Paving

##### 1.2 QUALITY ASSURANCE

- A. Reference Standards
  - 1. State of California "CALTRANS Standard Specifications," Sections 84.
  - 2. State of California, Title 24, Accessibility Standards and 'California Accessibility Reference Manual, November 1994.
  - 3. Manufacturer's specifications and recommendations.
  - 4. Perform all work in accordance with all applicable laws, codes and regulations required by the City of Brentwood.

##### 1.3 SUBMITTALS: Per Division 1 requirements.

- A. Data on paint with color samples.

#### PART 2 - PRODUCTS

##### 2.1 PAINTING

- A. Paints shall conform to CALTRANS Standard Specifications 84-2.
- B. Traffic paint and pavement markers shall include a slip-resistant, textured surface.
- C. Utilize paint compatible with the surfacing material.

#### PART 3 - EXECUTION

##### 3.1 PREPARATION

- A. Pavements shall be fully cured and clean.
- B. Lay out markings accurately and obtain approval before installation. Striping line width on pavement for play courts shall be 2" minimum wide and white except where noted on

drawings as yellow.

- C. Pavement markings shall be applied only on dry surfaces during periods of favorable weather. Temperature shall be above 35 degrees F. and rising, humidity less than 80 percent and falling, and no precipitation predicted for 24 hours.

### **3.2 INSTALLATION**

- A. Install pavement markings in accordance with reference standards.
  - 1. Paints, where indicated, shall be applied in accordance with CALTRANS Standard Specifications 84-3.03 through 84.3.05. Edges shall be clean and well defined.
  - 2. Apply two coats of paint to the satisfaction of the Project Inspector and Architect.

### **3.3 CLEANING:**

Per Division 1 requirements.

- A. Remove from premises; equipment, debris and surplus material needed for, or resulting from, this work. Remove excess adhesives or paint over-spray or tracking onto unmarked areas.
- B. All work shall be left in a condition satisfactory to the Project Inspector and Architect.

**END OF SECTION 32 1723**

## SECTION 32 3119

### ORNAMENTAL STEEL FENCES AND GATES

#### PART 1 GENERAL

##### 1.01 SUMMARY

###### A. Scope of Work

The Contractor shall furnish all labor, materials, and appurtenances necessary for installation of the industrial ornamental steel fence system defined herein.

###### B. Related Work:

1. 03 3000 Cast-In-Place Concrete
2. 32 3121 Double Heavy Duty Swing Gate

##### 1.02 COORDINATION

- ###### A. Coordinate work fully with all other trades involved. Coordinate with items of other trades to be furnished and set in place. Such portions of their work as is all or in part embedded, built-in, attached to, or supported by the work shall be executed by them in ample time that progress of the work is not delayed. Contractor shall be responsible for the proper installation of all items related to this section.

##### 1.03 SYSTEM DESCRIPTION

- ###### A. The Manufacturer shall supply a total industrial ornamental steel fence system of the Ameristar® Aegis II® Majestic design. The system shall include all components (i.e., pickets, rails, posts, gates and hardware) required.

##### 1.04 QUALITY ASSURANCE

- ###### A. The Contractor shall provide laborers and supervisors who are thoroughly familiar with the type of construction involved and materials and techniques specified.

##### 1.05 REFERENCES

- A. ASTM A653/A653M - Standard Specification for Steel Sheet, Zinc-Coated (Galvanized) or Zinc-Iron Alloy Coated (Galvannealed) by the Hot-Dip Process.
- B. ASTM B117 - Practice for Operating Salt-Spray (Fog) Apparatus.
- C. ASTM D523 - Test Method for Specular Gloss.
- D. ASTM D714 - Test Method for Evaluating Degree of Blistering in Paint.
- E. ASTM D822 - Practice for Conducting Tests on Paint and Related Coatings and Materials using Filtered Open-Flame Carbon-Arc Light and Water Exposure Apparatus.
- F. ASTM D1654 - Test Method for Evaluation of Painted or Coated Specimens Subjected to Corrosive Environments.
- G. ASTM D2244 - Test Method for Calculation of Color Differences from Instrumentally Measured Color Coordinates.

- H. ASTM D2794 - Test Method for Resistance of Organic Coatings to the Effects of Rapid Deformation (Impact).
- I. ASTM D3359 - Test Method for Measuring Adhesion by Tape Test.
- J. ASTM F2408 - Ornamental Fences Employing Galvanized Steel Tubular Pickets.

#### 1.06 SUBMITTAL

- A. Product Data: For each type of product indicated.
- B. Shop Drawings: For gates. Include plans, elevations, sections, details, and attachments to other work.
- C. Samples: For each fence material and for each color specified
  - 1. Provide Samples 12 inches in length for linear materials.
  - 2. Provide Samples 12 inches in length for sheet materials.
- D. Welding Certificates
- E. Product Test Reports: Based on evaluation of comprehensive tests performed by a qualified testing agency, for decorative metallic-coated steel tubular picket gates including finish, indicating compliance with referenced standard and other specified requirements.

#### 1.07 PRODUCT HANDLING AND STORAGE

- A. Upon receipt at the job site, all materials shall be checked to ensure that no damages occurred during shipping or handling. Materials shall be stored in such a manner to ensure proper ventilation and drainage, and to protect against damage, weather, vandalism and theft.

#### 1.08 PRODUCT WARRANTY

- A. All structural fence components (i.e. rails, pickets, and posts) shall be warranted within specified limitations, by the Manufacturer for a period of 10 years from date of original purchase. Warranty shall cover any defects in material finish, including cracking, peeling, chipping, blistering or corroding.
- B. Reimbursement for labor necessary to restore or replace components that have been found to be defective under the terms of manufactures warranty shall be guaranteed for five (5) years from date of original purchase.

#### 1.09 QUALITY ASSURANCE

- A. Installer Qualifications: Fabricator of products.
- B. Welding Qualifications: Qualify procedures and personnel according to AWS D1.1/D1.1M, "Structural Welding Code - Steel."
- C. Mockups: Build mockups to verify selections made under sample submittals and to demonstrate aesthetic effects and set quality standards for fabrication and installation.
- D. Include ten (10) foot length of fence complying with requirements.
- E. Approved mockups may become part of the completed Work if undisturbed at time of substantial Completion.
- F. Preinstallation Conference: Conduct conference at Project site.

- G. The Contractor shall provide laborers and supervisors who are thoroughly familiar with the type of constructions involved and materials and techniques specified.

## **PART 2 MATERIALS**

### **2.01 MANUFACTURER**

- A. The fence system shall conform to Ameristar Aegis II, Majestic with 3-3/4" picket gap style manufactured by Ameristar Fence Products, Inc. in Tulsa, Oklahoma, or approved equal.

### **2.02 MATERIAL**

- A. Steel material for fence framework (i.e. tubular pickets, rails and posts), shall be galvanized prior to forming in accordance with the requirements of ASTM A653/A653M, with minimum yield strength of 45,000 psi (310 MPa). The steel shall be hot-dip galvanized to meet the requirements of ASTM A653/A653M with a minimum zinc coating weight of 0.90 oz/ft<sup>2</sup> (276 g/m<sup>2</sup>), Coating Designation G-90.
- B. Material for pickets shall be 1" square x 14 Ga. tubing. The cross-sectional shape of the rails shall conform to the manufacturer's ForeRunner™ double wall design with outside cross-section dimensions of 1.75" square and a minimum thickness of 14 Ga. Picket holes in the ForeRunner rail shall be spaced 4.715" o.c., unless otherwise noted. Picket retaining rods shall be 0.125" diameter galvanized steel. High quality PVC grommets shall be supplied to seal all picket-to-rail intersections. Fence posts and gateposts shall meet the minimum size requirements of Table 1. See Structural Drawings for additional information.

### **2.03 FABRICATION**

- A. Pickets, rails and posts shall be precut to specified lengths. ForeRunner rails shall be prepunched to accept pickets. Pickets shall be predrilled to accept retaining rods.
- B. Grommets shall be inserted into the prepunched holes in the rails and pickets shall be inserted through the grommets so that predrilled picket holes align with the internal upper raceway of the ForeRunner rails (Note: This can best be accomplished by making an alignment jig). Retaining rods shall be inserted into each ForeRunner rail so that they pass through the predrilled holes in each picket.
- C. The manufactured galvanized framework shall be subjected to the PermaCoat® thermal stratification coating process (high-temperature, in-line, multi-stage, multi-layer) including, as a minimum, a six-stage pretreatment/wash, an electrostatic spray application of an epoxy base, and a separate electrostatic spray application of a polyester finish. The base coat shall be a thermosetting epoxy powder coating (gray in color) with a minimum thickness of 2 mils (0.0508mm). The topcoat shall be a "no-mar" TGIC polyester powder coat finish with a minimum thickness of 2 mils (0.0508mm). The color shall be Black. The stratification-coated framework shall be capable of meeting the performance requirements for each quality characteristic shown in Table 2.
- D. Completed sections (i.e., panels) shall be capable of supporting a 600 lb. load applied at midspan without permanent deformation. Panels shall be biasable to a 25% change in grade.

## **PART 3 EXECUTION**

3.01 PREPARATION

A. All new installation shall be laid out by the Contractor in accordance with the Drawings.

3.02 FENCE INSTALLATION

A. Fence post shall be spaced according to Table 3, plus or minus 1/2" and as shown in the Drawings. For installations that must be raked to follow sloping grades, the post spacing dimension must be measured along the grade. Fence panels shall be attached to posts with brackets supplied by the Manufacturer. See Structural Drawings for post and footing information.

3.03 FENCE INSTALLATION MAINTENANCE

A. When cutting/drilling rails or posts adhere to the following steps to seal the exposed steel surfaces; 1) Remove all metal shavings from cut area. 2) Apply zinc-rich primer to thoroughly cover cut edge and/or drilled hole; let dry. 3) Apply 2 coats of custom finish paint matching fence color. Failure to seal exposed surfaces per steps 1-3 above will negate warranty. Fence Manufacturer's spray cans or paint pens shall be used to prime and finish exposed surfaces; it is recommended that paint pens be used to prevent overspray. Use of non-compliant parts or components will negate the Manufacturers' warranty.

<b>Table 1 - Minimum Sizes for Aegis II Posts</b>				
<u>Fence Posts</u>	<u>Panel Height</u>			
2-1/2" x 12 Ga.	Up to & Including 6' Height			
3" x 12 Ga.	Over 6' Up to & Including 10' Height			
4" x 11 Ga.	Over 10' Height			
<u>Gate Leaf</u>	<u>Gate Height</u>			
	<u>Up to &amp; Including 6'</u>	<u>Over 6' Up to &amp; Including 8'</u>	<u>Over 8' Up to &amp; Including 10'</u>	<u>Over 12'</u>
Up to 4'	3" x 12Ga.	3" x 12 Ga.	4" x 11 Ga.	4" x 11 Ga.
4'1" to 6'	3" x 12Ga.	3" x 12 Ga.	4" x 11 Ga.	4" x 11 Ga.
6'1" to 8'	4" x 11 Ga.	6" x 3/16"	6" x 3/16"	6" x 3/16"
8'1" to 10'	4" x 11 Ga.	6" x 3/16"	6" x 3/16"	6" x 3/16"
10'1" to 12'	6" x 3/16"	6" x 3/16"	6" x 3/16"	8" x 1/4"
12'1" to 16'	6" x 3/16"	6" x 3/16"	8" x 1/4"	8" x 1/4"

<u>Quality Characteristics</u>	<u>ASTM Test Method</u>	<u>Performance Requirements</u>
Adhesion	D3359 - Method B	Adhesion (Retention of Coating) over 90% of test area (Tape and knife test).
Corrosion Resistance	B117, D714 & D1654	Corrosion Resistance over 3,500 hours (Scribed per D1654; failure mode is accumulation of 1/8" coating loss from scribe or medium #8 blisters).
Impact Resistance	D2794	Impact Resistance over 60 inch lb. (Forward impact using 0.625" ball).
Weathering Resistance	D822 D2244, D523 (60° Method)	Weathering Resistance over 1,000 hours (Failure mode is 60% loss of gloss or color variance of more than 3 delta-E color units).

Span	For INVINCIBLE® 8' Nominal (91.25" Rail)		For CLASSIC, GENESIS, & MAJESTIC 8' Nominal (92.625" Rail)					
Post Size	2-1/2"	3"	2-1/2"	3"	2-1/2"	3"	2-1/2"	3"
Bracket Type	Industrial Flat Mount (BB301)		Industrial Universal (BB302)	Industrial Universal (BB303)	Industrial Flat Mount (BB301)		Industrial Swivel (BB304)*	
Post Settings ± 1/2" O.C.	94-1/2"	95"	96"	96.5"	96"	96-1/2"	*97-1/2"	*98"
Span	For INVINCIBLE® 6' Nominal (67.75" Rail)		For CLASSIC, GENESIS, & MAJESTIC 6' Nominal (71.375" Rail)					
Post Size	2-1/2"	3"	2-1/2"	3"	2-1/2"	3"	2-1/2"	3"
Bracket Type	Industrial Flat Mount (BB301)		Industrial Universal (BB302)	Industrial Universal (BB303)	Industrial Flat Mount (BB301)		Industrial Swivel (BB304)*	
Post Settings ± 1/2" O.C.	75"	75.5"	71.5"	72"	71.5"	72"	*73"	*73.5"
*Note: When using BB304 swivel brackets on either or both ends of a panel installation, care must be taken to ensure the spacing between post and adjoining pickets meets applicable codes. This will require trimming one or both ends of the panel.								

**END OF SECTION**



## SECTION 32 3121

### DOUBLE HEAVY DUTY SWING GATE

#### PART 1 GENERAL

##### 1.01 SUMMARY

- A. The work in this section shall include furnishing all labor, materials, equipment and appliances necessary to complete all Heavy Duty Swing Gate Systems required for this project in strict accordance with this specification section and the Drawings.
- B. Related Work:
  - 1. 03 3000 Cast-In-Place Concrete
  - 2. 32 3119 Ornamental Steel Fences and Gates

##### 1.02 REFERENCES

- A. Underwriters Laboratory Gate Operator Requirements (UL 325).
- B. ASTM F 2200 Standard Specification for Automated Vehicular Gate Construction.
- C. American Welding Society AWS D1.2 Structural Welding Code.
- D. ASTM F 900 Standard Specification for Industrial and Commercial Swing Gates.

##### 1.03 SUBMITTALS

- A. Product Data
  - 1. Provide Manufacturer's catalog cuts with printed specifications and installation instructions.
  - 2. Deliver two copies of operation and maintenance data covering the installed products. Manual to include parts list showing Manufacturer's names and part numbers for the gate operator.
- B. Shop Drawings
  - 1. Supply shop drawings showing the relationship of operating systems with gate components, including details of all major components.
  - 2. Include complete details of gate construction, gate height and post spacing dimensions.
- C. Certifications
  - 1. Gate Manufacturer shall provide independent certification as to the use of a documented Welding Procedure Specification and Procedure Qualification Record to insure conformance to the AWS D1.2 welding code. Upon request, Individual Certificates of Welder Qualification documenting successful completion of the requirements of the AWS D1.2 code shall also be provided.

#### PART 2 PRODUCTS

##### 2.01 SWING GATE SYSTEM MANUFACTURER

- A. The double swing gate system shall be manufactured by Tymetal Corp., 678 Wilbur Avenue, Greenwich, NY 12834 - (800) 328-4283, or approved equal.
- B. Approved Substitution: All other systems must be submitted to the District in accordance with substitution requirements as set forth in the general provisions of the specification

manual for approval prior to the bid date. Products submitted after the bid date will not be approved.

## 2.02 GATE CONSTRUCTION DETAILS

### A. Gate Frame

1. The gate frame shall be fabricated from 6063-T6 aluminum alloy extrusions. The top member shall be a 3" x 5" (76mm x 127mm) aluminum structural channel/tube extrusion weighing not less than 3.0 lb/lf (4.4kg/m) for Internal Picket designs or 2.6 lb/lf (3.8kg/m) for External Picket designs. The bottom member shall be a 2" x 5" (51mm x 127mm) aluminum structural tube weighing not less than 2.0 lb/lf (2.9kg/m).
2. Vertical Members
  - a. Ornamental Picket (Internal and External): The vertical members at the ends of the opening portion of the frame shall be 2" x 2" (51mm x 51mm) in the cross section weighing not less than 1.1 lb/lf (1.6kg/m). The major vertical members separating each bay shall be 1" x 2" (25mm x 51mm) in cross section weighing not less than .82 lb/lf (1.2kg/m). The spacing for the major vertical members shall be less than 50% gate frame height.
3. All welds on the gate frame shall conform to Welding Procedure Specification and Procedure Qualification Record to insure conformance to the AWS D1.2 Structural Welding Code. All individual welders shall be certified to AWS D1.2 welding code. See 1.03 C.1.
4. Each gate leaf shall be provided with a minimum of two pivoting hinges to allow proper operation, and shall be connected to the gate side of the hinge by means of two through-bolts.

### B. Diagonal Bracing

1. Diagonal "X" bracing of 3/16" or 1/4" diameter stainless or galvanized steel cable shall be installed throughout the gate to provide additional vertical adjustment.

### C. Posts

1. Gate hanger posts shall be sized in accordance with gate dimensions as specified by the Manufacturer. Height of the post and depth of footing shall be as specified by the Structural Engineer.

### D. Lock

1. Single gates shall have a latch assembly to provide a means for locking with a padlock.
2. Double gates shall have a drop-bar mechanism extending into the ground, and a center locking kit to provide a means for locking with a padlock.

### E. The gate shall be completed by installation of approved filler as specified.

1. Ornamental Picket: The gate shall be completed by installation of ornamental pickets. Picket sizes shall be 1" (25mm) square and shall extend through entire length of the gate panel.

### F. Finish

1. Gate shall be mill finish aluminum or color coated with polyester powder as specified. If powder coated, the gate and all accessories shall be pretreated chemically by sand blasting or other acceptable method to ensure proper coating adherence. Gate posts shall be galvanized or coated to match the gate.

### **PART 3 EXECUTION**

#### **3.01 INSTALLATION**

- A. Excavate, place concrete and install specified sized posts as detailed, and in accordance with approved shop drawings. Install hinges on gate frame and gateposts. Make final adjustments to maintain alignment of gate leaves. Install equipment of this section in strict accordance with the Manufacturer's printed instructions unless otherwise shown on the Drawings.
- B. The gate and installation shall conform with ASTM F 900 standards for aluminum swing gates.
- C. If the gate system is automated, the gate and installation shall comply with UL 325 Gate Operator Requirements and ASTM F 2200, Standard Specifications for Automated Vehicular Gate Construction.

#### **3.02 SYSTEM VALIDATION:**

- A. The complete system shall be adjusted to assure it is performing properly.
- B. The system shall be operated for a sufficient period of time to determine that the system is in proper working order.
- C. For operated gate systems - test and explain safety features:
  - 1. Each system feature and device is a separate component of the gate system.
  - 2. Read and follow all instructions for each component.
  - 3. Ensure that all instructions for mechanical components, safety devices and the gate operator are available for everyone who will be using the gate system.
  - 4. The warning signs shipped with the gate operator must be installed in prominent position on both sides of the gate.
  - 5. Ensure the District is clear with regard to the safety points concerning the basic operational guidelines of the safety features of the gate operator system. These safety points are listed in the gate operator manual and must be read prior to system use.

**END OF SECTION**

## SECTION 32 8000

### IRRIGATION SYSTEM

#### PART 1 GENERAL

##### 1.01 DESCRIPTION

- A. The General Conditions and all other Contract Documents for this project are complementary and applicable to this Section of the Specifications.
- B. Work Included: Order and furnish all labor, materials, supplies, tools and transportation and perform all operations for a complete installation of the recycled water connection and automatic irrigation system as shown on the Drawings. Items listed hereinafter are included as an aid to estimating quantities and are not necessarily a complete list of work items.
  - 1. Trenching, stockpiling excavation materials, and refilling trenches.
  - 2. Furnishing materials and installation for complete system including point of recycled water connection, self-flushing filter, sump, master control valve, flow sensor, piping, valves, fittings, sprinkler heads, bubblers, automatic controller, final adjustment of sprinkler heads, bubbler heads, and subsurface drip emitter tubing to ensure complete coverage of water to plants and trees.
  - 3. Low voltage control wiring from irrigation controller to remote control valves.
  - 4. Replacement of unsatisfactory materials.
  - 5. Clean-up, inspection and approval.
  - 6. All work of every description mentioned in the Specification and/or addenda thereto, and all other labor and materials reasonably incidental to the satisfactory completion of the work, including clean-up of the site, as directed by the District.
  - 7. Tests.
  - 8. Record Drawings.
- C. Related Work Described Elsewhere:
  - 1. 26 0000: Electrical Specification
  - 2. 32 9000: Landscape Planting

##### 1.02 GENERAL REQUIREMENTS

- A. Purpose: It is the intention of these Specifications to accomplish the work of installing an irrigation system which shall operate in an efficient manner, provide 100% uniform coverage, and be water conserving. The Drawings indicate the general arrangement of piping and equipment, and do not necessarily indicate all offsets, fittings and accessories that may be required. Furnish incidental materials and labor not specifically called for but required to complete work as intended.
- B. OSHA Compliance: All articles and services covered by this Specification shall meet or exceed the safety standards established under the Federal Occupational Safety and Health Act of 1970, together with all amendments in effect as of the date of this Specification.
- C. Codes and Standards: Comply with all applicable codes and standards.
  - 1. Perform work in accordance with the District's (LUHSD) standards.
  - 2. Work and materials shall be in full accordance with the latest rules and regulations of the California Electric Code, the Uniform Plumbing Code, published by the Western Plumbing Officials Association and other applicable State or local laws or regulations. Nothing in

these Drawings or Specifications shall be construed to permit work not conforming to these codes.

3. When the Specifications call for materials or construction of a better quality or larger size than required by the above-mentioned rules and regulations, the provision of the Specifications shall take precedence over the requirements of the said rules and regulations.
4. Furnish, without any additional cost to the District, any additional material and labor required to comply with these rules and regulations. Provide the work even if it is not mentioned in this section, or shown on the Drawings.
5. Erect and maintain barricades, guards, warning signs and lights as required by the District or required by OSHA regulations for the protection of the public or work crew.
6. Damage by Leaks: The Contractor shall be responsible for damages to any property or work caused by leaks in the piping systems being installed. Repair, at no additional expense to the District, all damages so caused. All repair work shall be done as directed, and in a manner that is satisfactory to the District.
7. Protection: The Contractor shall be responsible for any damage to this work, which occurs before final acceptance. Securely cover all openings into the systems and protect all apparatus, equipment and appliances, both before and after being set in place, to prevent obstructions in the pipes and breakage, misuse or disfigurement of the apparatus, equipment of appliance.

### 1.03 QUALITY ASSURANCE

- A. Provide evidence to the District that skilled and an experienced supervisor and work crew will be employed on the job from beginning to end.
- B. Provide evidence to the District that the Contractor is skilled and experienced in the construction of a commercial-grade irrigation system. Contractor shall provide with the bid documents a list of at least five irrigation projects constructed in the last five years by the Contractor that have used the listed equipment.

### 1.04 INSTRUCTION

- A. After the system has been installed and approved, instruct the District's personnel in the complete operation and maintenance of the irrigation system.

### 1.05 SUBMITTALS

- A. Equipment List and Drawings: Within 14 days after date of Notice to Proceed, submit to the District for approval, a list of the proposed equipment and material to be furnished and installed. The list shall be complete as to name of manufacturer, size and catalog number of unit, and be supplemented by such other data as may be required, including detailed scale Drawings, plumbing and wiring diagrams. Submit materials list using the following format:

<u>Item</u>	<u>Description</u>	<u>Manufacturer</u>	<u>Model No.</u>
1	Pressure Supply Line	Lasco	Sch. 40
2	Lawn Head	Rainbird	2400

- B. Record Drawings:

1. Record accurately on one set of blue or black line prints, changes in the work constituting departures from the original contract Drawings, including changes in pressure and non-pressure line locations, and a complete schematic diagram.
2. Record the changes and dimensions in a legible manner and to the satisfaction of the District. Prior to final inspection of work, and prior to transferring the information to mylars, submit record prints to the District for approval.
3. Dimension from two permanent points of reference (buildings, monuments, sidewalks, curbs, pavements, etc.). Record data to be shown on record prints, day-to-day, as the project is being installed.
4. Show locations and depths of the following items:
  - a. Point of connection.
  - b. Routing of irrigation main line pipe. Provide dimensions a minimum of 100 feet along main line route.
  - c. Gate valves.
  - d. Remote control valves or valve groups.
  - e. Routing of control wires.
  - f. Routing of conduit.
  - g. Sleeves.
  - h. Related equipment including sprinkler heads (as may be directed by the District).
5. Maintain record prints on-site at all times.
6. Upon completion of work, transfer all as-built information and dimensions to reproducible sepia mylars. Correct and record the changes and dimensions in a legible manner and to the satisfaction of the District.

## **PART 2 PRODUCTS**

### **2.01 PIPE: SITE IRRIGATION**

- A. Pipe manufacturer: PW Pipe, JM Eagle Pipe, or approved equal.
- B. Pipe Material: Polyvinylchloride (PVC) plastic in conformance with ASTM D1784 (cell class 12454-B).
- C. Schedule or Class:
  1. Main line pipe:
    - a. 2.5-inch and smaller: Schedule 40 PVC plastic pipe with solvent cemented joints.
    - b. Purple for use with recycled water.
  2. Lateral line pipe (non-pressure):
    - a. Schedule 40 PVC plastic pipe with Schedule 40 Type I, Grade I, PVC with solvent weld or threaded fittings as shown on the Drawings.
    - b. Purple for use with recycled water.
- D. Identification marking: Pipe shall be clearly marked at regular intervals indicating the manufacturer's name, nominal pipe size, schedule or class, pressure rating in PSI, date of extrusion, and recycled water use warnings.
- E. Sleeves: 1120-Schedule 40 or Class 200 PVC pipe, whichever has the thickest wall thickness, minimum of two times the diameter of pipe contained within.
- F. Connections between main lines and remote control valves: Schedule 80 PVC (threaded both ends) nipples and fittings as per the construction details.

### **2.02 PVC PIPE FITTINGS**

- A. 2.5-inch and smaller PVC fitting manufacturer: Lasco, Dura, Spears, or approved equal.
- 2.03 GATE OR BALL VALVES**
- A. Provide the valves as listed on the Drawings.
- B. Gate valves shall have a resilient wedge.
- C. Ball valves shall be the full port style.
- 2.04 MASTER CONTROL VALVE AND FLOW SENSOR**
- A. The master valve and flow sensor are included in the Liberty Union High School Stadium Improvement Irrigation System contract work.
- 2.05 REMOTE CONTROL VALVE**
- A. Provide the solenoid remote control valves as listed on the Drawings.
- 2.06 QUICK COUPLING VALVE**
- A. Provide the quick coupling valves as listed on the Drawings.
- 2.07 BOXES FOR CONTROL VALVES, QCV, AND GATE VALVE**
- A. Remote control valves, and pull boxes: Carson Model 1419, 12-inch x 17-inch x 12 inch-deep (top dimensions) valve box with bolt-down plastic lid or approved equal. Lid shall be marked: "Irrigation".
- B. Gate valve and quick coupling valve: Carson Model 910, 12-inch deep round plastic valve box with plastic lid. Lid shall be marked: "Irrigation".
- C. Quick coupling valve in concrete pavement: Old Castle (Christy) Concrete Model B1419-51GH, 22-1/4-inch x 15-5/8-inch x 12-inch deep (top dimensions) traffic valve box, H/20 loading, steel checker plate bolt-down cover with 5-inch x 8-inch reading lid.
- D. Use plastic box extensions made by the same manufacturer and of equal size to the valve box as required to allow access to the valve.
- E. The valve box and lid shall be a purple color, as manufactured by the vendor.
- 2.08 CONTROLLER**
- A. The controller is included in the Liberty Union High School Field Improvement Irrigation System contract work.
- 2.09 LOW VOLTAGE WIRE**
- A. 2-Wire type: Polyethylene double-jacketed or UF-B UL PVC double-jacketed two-conductor solid core designed for direct burial with insulation 3/16 inch (.060") thick, high density, sunlight resistant incased in an outer jacket of polyethylene or PVC conforming to ICEA S-GL-402 or NEMA WC5, having a minimum wall thickness of .045 inches. (#TW-CAB-14) All wire insulation shall be intact and free of nicks and cuts. (Two-wire Polyethylene "twisted" cable does NOT conform to these specifications.) Provide Rainmaster 2-wire cable.
- B. Notes:
1. All wire insulation shall be intact and free of nicks and cuts.
  2. All wire connections need to be absolutely water tight.

- 3. Wiring Sizes: Standard wire lengths for straight line installation i.e. wire distance to the furthest device without any loop: (Wire size chart is provided for reference only, #14G wire or larger is always recommended as specified above.)

Wire size (gauge)	#14	#12
Total loop wire length (ft.)	10,000	14,800
Distance to furthest valve (ft.)	5,000	7,400

- C. Weatherproof splices: 3M model 3M-DBY, King model Dryconn #10999, Spears model #400 pre-filled seal packs or approved equal.

**2.10 IRRIGATION HEADS**

- A. Provide and install the spray, bubbler, and emitter systems as listed on the Drawings.
- B. Irrigation head body and risers: Provide and install bodies and risers as shown in the construction details using Schedule 80 PVC threaded nipples with Schedule 80 PVC elbows, District approved vendor pre-fabricated swing joints, or algae resistant flexible PVC tubing.

**2.11 PULL BOXES**

- A. Install pull boxes at the locations shown on the plans or at locations designated by the District at site of work. Contractor may, at no additional expense to the District, install additional pull boxes to facilitate work with good reason.
- B. Carson Model 1419, 12-inch x 17-inch x 12-inch deep valve box with bolt-down plastic lid or approved equal. Lid shall be marked: "Irrigation". Black color boxes are acceptable for electrical pull boxes.

**2.12 PVC-CONDUIT**

- A. Polyvinylchloride conduit: heavy-wall, Schedule 40, with factory made solvent cemented socket sweep elbows, couplings and fittings, as permitted by NEC.

**2.13 RECYCLED WATER MARKING (VALVES)**

- A. Manufacturer: T. Christy Enterprises part no. 3150 (no known equal).
- B. Material: Polyurethane behr desopan.
  - 1. 3 inch by 4 inch in size and hot stamped with 1-1/8 inch black letters on a yellow background, which states in English and Spanish "WARNING - RECYCLED WATER - DO NOT DRINK".
  - 2. Manufacturer provided punched hole.

**2.14 VALVE IDENTIFICATION TAGS**

- A. Manufacturer: T. Christy Enterprises, or equal (no known equal.)
- B. Material: Polyurethane behrdesopan
- C. Attributes:
  - 1. 2.25 inch by 2.75 inch hot stamped with 1-1/8 inch black letters on a yellow background.
  - 2. Indicates controller letter or number and valve station number.

**2.15 MARKING TAPE**



- A. Marking tape shall be a detectable underground utility marking tape as follows:
  - 1. It shall consist of a minimum 4.0 mil (0.004) thickness, inert 100% linear low-density polyethylene plastic film formulated for extended use underground.
  - 2. The tape tensile strength shall be in accordance with ASTM D882 and not be less than 4100 MD and 3650 TD.
  - 3. Elongation properties shall be in accordance with ASTM D882 and be greater than 550%+ at break point.
  - 4. Tape flexibility shall be in accordance with ASTM D671 and shall remain pliable.\
  - 5. The materials shall be acid and alkali resistant.
  - 6. Width of warning tape shall be 6-inch.
- B. Color Coding: The tape shall conform to the American Public Works Association color code as follows:
  - 1. Recycled/Recycled Water Pipelines: Tape color shall alert purple.
- C. Message Inscription: The tape shall include an inscription in black letters to identify the type of utility pipeline on or over which it is installed. The inscription shall be impregnated with colorfast, lead-free, organic pigments suitable for direct burial and prolonged exposure to the elements normally encountered in moderately corrosive type soils. The height of the message letters shall be 1.5 inches minimum, and the message inscription shall be repeated at approximately 3-foot intervals. The message inscription for the different types of pipelines shall be as follows:
  - 1. Recycled/Recycled Water Pipelines: The message on the tape shall be:

**"CAUTION RECYCLED/RECYCLED WATER LINE BURIED BELOW"**
- D. Warning tape shall be manufactured by T. Christy Enterprises, Inc., or approved equal. Model for recycled water: TA-DT-6-PRW.

## **2.16 MISCELLANEOUS INSTALLATION MATERIALS**

- A. Solvent cement and primer for solvent weld joints: make and type approved by manufacturer(s) of pipe and fittings. Maintain cement at proper consistency throughout use. IPS Weld-On, Oatey, or approved equal.
- B. Pipe joint compound: non-hardening, non-toxic materials designed specifically for use on threaded connections in water carrying pipe. Rectorseal T+2 pipe thread sealant or approved equal.
- C. Pipe lubricant: All-purpose pipe lubricant shall be used for assembling gasketed PVC pipe. Pipe Lubricant is a mixed fatty acid soap dispersed in glycols and water solvents with a clay pigment filler. Pipe lubricant can be applied from -10° F to 150° F. It will not deteriorate natural or synthetic rubber, plastic gaskets, cast or ductile iron pipe. Pipe lubricant contains no petroleum oils or phosphates and will not support bacterial growth. Oatey or approved equal.

## **2.17 MISCELLANEOUS EQUIPMENT**

- A. Provide all equipment called for by the Drawings.

## **PART 3 INSTALLATION**

### **3.01 PREPARATION**

- A. General: Prior to all work of this section, carefully inspect the installed work of all other trades and verify that their work is complete or to the point where this installation may properly commence. Verify that irrigation system can be installed in strict accordance with pertinent codes and regulations, the original design, the referenced standards and the manufacturer's recommendations.

In the event any equipment or methods indicated on the Drawings or in Specifications conflicts with local codes, immediately notify the inspector prior to installing. If this notification is not provided, assume full responsibility for the cost of all revisions necessary to comply with code.

Grades: Before starting work, carefully check grades to determine that work may safely proceed, keeping within the specified material depths with respect to finish grade.

Coordination with work of other trades: Provide all necessary measurements in the field to ensure precise fit of items in accordance with the original design. Coordinate the installation of irrigation materials with all other work. Give special attention to coordination of piping locations with new and existing signage, light standards, hydrants, and other utility locations to avoid conflicts.

- B. Recycled Water Supply: Connect the water supply to location as shown on the Drawings. Make minor changes caused by actual site conditions at no additional cost to the District. All required testing shall be successfully completed prior to connection.

### **3.02 HANDLING AND STORAGE**

- A. Protect work and materials from damage during construction and storage as directed by the District.
- B. Handle plastic pipe carefully; especially protect it from prolonged exposure to sunlight.

### **3.03 LAYOUT**

- A. Lay out work in accordance with diagrammatic construction Drawings.
- B. Stake out the irrigation system as shown on the Drawings. Obtain approval from the District before starting work.
- C. Where site conditions do not permit location of piping, valves and heads where shown, notify the District immediately and determine relocation in joint conference.
- D. Run pipelines and automatic control wiring in common trenches wherever practical. When pipe and wire area placed in the same trench, it is required that a minimum separation of 3 inches shall be maintained between pipes and/or pipes and wiring.
- E. Irrigation heads, valves, and boxes shall not be placed in the path of gates or vehicular/pedestrian traffic. Determine the proper locations at the time of staking the irrigation system.
- F. During spray head layout do not exceed the maximum operating radius of the spray heads at 30 psi.

### **3.04 EXCAVATING AND TRENCHING**

- A. Excavate trenches ample in size to permit the pipes to be laid at the elevations intended and to permit ample space for joining. When two pipes are to be placed in the same trench, maintain a 3-inch minimum separation between pipes.

- B. Make trenches for pipelines deep enough to provide minimum cover from finish grade as follows:
  - 1. 6-inch diameter main line pipe: 24-inch minimum cover over main line.
  - 1. 2.5-inch and smaller main line pipe: 18-inch minimum cover over main line.
  - 2. Lateral line pipe: 12-inch minimum cover.
  - 3. Low voltage wire: 18-inch minimum cover.
- C. Restore surfaces, existing underground installations, utilities, plant materials, etc., damaged or cut as a result of excavations, to original conditions in manner approved by the District.
- D. Where other utilities interfere with irrigation trenching and pipe work, adjust the trench depth as instructed by the District.

### 3.05 ASSEMBLING PIPELINES

- A. Assemble pipe free from dirt and pipe scale. Ream field cut ends to full pipe diameter with rough edges and burrs removed.
- B. Solvent-Weld Main Line: At changes in direction or branch mains, use appropriate Schedule 40 PVC fittings as approved by the Uniform Plumbing Code.
- C. Solvent Weld Joint:
  - 1. Prepare joint by first making sure the pipe end is square, then deburring the pipe end and cleaning pipe and fittings of dirt, dust and moisture.
  - 2. Dry-insert pipe into fitting. Pipe should enter fitting 1/3 to 2/3 depth of socket.
  - 3. Coat the inside of socket surface of the fitting and the external surface of the male end of the pipe with solvent cement primer (P-70 as manufactured by Weld-On or approved equal). Then without delay, apply solvent cement (Weld-On 711 as manufactured by Weld-On or approved equal) liberally to the male end of the pipe and apply solvent cement lightly to the inside of the socket. Now, apply a second coat of solvent cement to the pipe end. (Solvent cement with primer incorporated into the solvent cement may be used.)
  - 4. Insert pipe immediately into fitting and turn ¼ turn to distribute cement and remove air bubbles. The pipe must seat to the bottom of the socket and fitting. Check alignment of the fitting. Align the pipe and fitting properly to prove no strain to either.
  - 5. Hold joint still for approximately thirty (30) seconds and then wipe excess cement from the pipe and fitting.
  - 6. Cure joints a minimum of thirty (30) minutes before handling and at least six (6) hours before allowing water in the pipe.
- D. Threaded Joint:
  - 1. Field threading of plastic pipe or fittings is not permitted. Provide factory-formed threads only.
  - 2. Field-cut threads in metallic pipe will be permitted only where necessary. When field threading, cut threads accurately an axis with sharp dies.
  - 3. Provide threaded joints with pipe joint compound. Apply compound to male threads and first two female threads only.
  - 4. Where assembling metallic pipe to metallic fitting or valve, no more than one full turn beyond hand tight.
  - 5. Where assembling to threaded plastic fitting, take up joint no more than one full turn beyond hand tight.
  - 6. Where assembling soft metal (brass or copper) or plastic pipe, use strap type friction wrench only; do not use metal-jawed wrench.

- E. Cap or unplug openings as pipeline is assembled to prevent entrance of dirt or obstruction. Remove caps or plugs only when necessary to continue assembly.
- F. Where pipes or control wires pass through sleeves, provide removable non-decaying plug at ends of sleeve to prevent entrance of earth.

### **3.06 SLEEVES AND ELECTRICAL CONDUIT**

- A. Install sleeves to carry main line pipe, lateral line pipe, and wire under concrete and asphalt surfaces. Provide a sleeve even if the Drawings do not indicate a sleeve under the concrete and asphalt surfaces.
- B. Install pvc electrical conduit to carry control wires under concrete and asphalt surfaces where a sleeve does not exist for main and/or lateral line pipe.
- C. Install pvc electrical conduit to carry control wires under soil, concrete, and asphalt surfaces for master control valve and flow sensor cable. Provide a separate conduit for each item.
- D. Sleeves and/or conduit under existing paving: Bore for sleeves and/or conduit under existing paving and extend 12 inches beyond paving edge. Provide a separate sleeve for each water line and conduit for electrical control wires.

### **3.07 REMOTE CONTROL VALVES**

- A. Install where shown and on Drawings and group together where practical. Provide only remote control valve per box without exceptions
- B. Locate valve boxes 12 inches from and perpendicular to hardscape edges and walls.
- C. Provide 12 inches between valve boxes where valves are grouped together.
- D. Thoroughly flush main line before installing valve.
- E. Install in shrub or ground cover areas.
- F. Adjust remote control valve flow stems as follows:
  - 1. The most remote sprinkler heads operate at the pressure recommended by the head manufacturer.
  - 2. Uniform distribution of water is applied by the sprinkler heads to the planting areas.
- G. Label control line wire at each valve with a 2-1/4-inch x 2-3/4-inch polyurethane I.D. tag, indicating identification number of valve (controller and station number). Attach label to control wire.

### **3.08 QUICK COUPLING VALVES**

- A. Install where shown and on Drawings.
- B. Round QCV valve boxes installed in landscape areas shall be located at a 12-inch distance from hardscape edges and walls.
- C. Rectangular concrete QCV valve boxes installed in pavement areas shall be located flush with pavement and aligned with pavement score joints.
- D. Thoroughly flush main line before installing valve.
- E. Install in shrub or ground cover areas except for four QCV's located in pavement for synthetic turf wash down purposes.

### **3.09 VALVE BOXES**

- A. Provide and install remote control valves, gate valves, or other valves in a valve box as shown in details, complete with cover bolted to valve box at the finish of work.
- B. Set valve boxes to finish grade in turf areas and 2 inches above finish grade in groundcover areas.
- C. Install one remote control valve in one valve box - no exceptions.
- D. Do not allow valve boxes to rest on pipes.
- E. Provide a 2-inch minimum clear distance between valve and the box wall.
- F. Install valve boxes located near walks, curbs, headerboards and paving in such a way as to allow for valve boxes to abut those items with top lid surface matching plane of items listed above.

### **3.10 AUTOMATIC CONTROL WIRING**

- A. Run wires along mains wherever practical. Tie wires in bundles with pipe wrapping tape at 10-foot intervals and allow slack for contraction between strappings. Do not tape wire together where contained within sleeving of conduit.
- B. Loop a minimum of three (3) feet of extra 2-wire cable in each valve box.
- C. Provide an expansion curl within three (3) feet of each solenoid wire connection. Form expansion curls by wrapping at least 5 turns of wire around a 1 -inch diameter pipe, then withdraw the pipe.
- D. Make connections by crimping bare wires with brass connectors and sealing with splice kits as detailed.
- E. Field splicing will be permitted only upon inspection and written approval from the District. Locate splices at valve locations within valve boxes.
- F. Where control lines pass under paving, install wire in Schedule 40 electrical PVC conduit or inside a sleeve for irrigation pipes.

### **3.11 CONTROLLER**

- A. The controller is included in the Liberty Union High School Field Improvement Irrigation System contract work.
- B. Connect control lines to existing controller in sequential arrangement per assigned identification number of valve. Label each control line wire at controller with a permanent, non-fading label indicating station number of valve controlled. Attach label to control wire.
- C. Arrange for the entire controller and installation to be approved and certified by the controller assembly vendor in writing. Provide written certification to the District.

### **3.12 BACKFILLING**

- A. Obtain Architect's approval for master valve, flow sensor, valve manifolds, gate valves, main line pipe, and lateral line pipe prior to backfill at these items.
- B. Backfill only after piping has been tested, inspected and approved by the District.

- C. Backfill material: earth excavated from the trenches, free from rocks, concrete chunks and other foreign or coarse materials.
- D. Place backfill materials in 4 -inch layers and compact to between 85 and 90% relative compaction.
- E. Dress areas to finish grades and remove excess oil, rocks or debris remaining after backfill is completed.
- F. If settlement occurs along trenches, and adjustments in pipes, valves and sprinkler heads, soil, sod or paving are necessary to bring the system, soil, sod or paving to the proper level or the permanent grade, as part of the work under this Contract, make all adjustments without additional cost to the District.

### **3.13 SPRINKLER AND BUBBLER HEADS**

- A. Thoroughly flush lines before installing heads.
- B. Locate heads as shown in the Drawings and detail.
- C. Adjust sprinkler heads for proper distribution and trim.
- D. Adjust bubbler heads to apply water on the container rootball.
- E. Install turf heads 2 inches above grade in seeded lawn area at time of installation. Lower to finished grade after turf is well established and as directed by the District.

### **3.14 TESTS**

Perform tests as specified below. Remake any faulty joints with new materials. Use of cement or caulking to seal leaks is absolutely prohibited.

- A. Record Prints: No testing or system observation shall commence without "record" prints. In the event the Contractor calls for testing or system observation without up to date "record" prints, without completing previously noted corrections, or without preparing the system for testing or system observation, the testing or system observation will be canceled and the Contractor will be charged for the direct costs of all District personnel's time and consultant's time lost. Testing or system observation will be required for:
  - 1. Cross-connection control testing
  - 2. Pressure test of irrigation main line.
  - 3. Coverage test.
  - 4. Start of maintenance period.
  - 5. Final acceptance.
- B. Notify LUHSD at least three (3) days in advance of testing.
- C. Perform testing at no additional expense to the District and in the presence of the District.
- D. Center load piping with small amount of backfill to prevent arching or slipping under pressure. No fitting shall be covered.
- E. Pipe test for solvent welded main line: Apply the following tests after weld plastic pipe joints have cured at least 24 hours:
  - 1. Prior to the installation of any valves to the main line, flush pipes with water and fully expel air from piping. Cap ends of pipe and test pressure lines with the line fully charged with water.

2. Test live (constant pressure) piping hydrostatically at 125-psi minimum. Lines will be approved if test pressure is maintained for six (6) hours. Contractor shall make tests and repairs as necessary until test conditions are met.
  3. Test RCV controlled (lateral) lines prior to installation of sprinklers or bubblers with water at line pressure and risers capped, and visually inspect for leaks. Retest after correcting defects.
- F. Leakage testing of 6-inch main lines with gasketed connections and push-on ductile iron fittings:
1. Conform leakage testing with AWWA Standard C605-94, Section 7, except as otherwise required by the Contract Documents as follows: (1) add water slowly to pipe to avoid water or air hammer damage, (2) bleed air out of system through quick coupling valves to insure air is exhausted, (3) pressurize system to 125 PSI for a minimum period of 6 hours. The test pressure shall be maintained at a constant pressure through the period of test.
- G. Coverage Test: When the irrigation system is completed, perform a coverage test in the presence of the District to determine if the water coverage for planting areas is complete and adequate. Provide this test prior to planting. Overspray that causes runoff to non-landscaped areas such as storm drain system, streets, or waterway shall not be permitted. Overspray on drinking fountains or picnic areas shall not be permitted.
- H. Testing of Electrical System:
- Prior to acceptance of the work, provide the following tests to wiring:
1. Continuity test of each circuit.
  2. Ground fault of each circuit.
  3. A functional test to demonstrate that each part of the system functions as specified or intended herein.
- I. Irrigation Audit: Submit to the Architect as part of the irrigation documentation package a schedule of landscape irrigation audits, satisfying the following conditions:
1. Landscape irrigation audits for new or rehabilitated landscapes shall be conducted by a certified landscape irrigation auditor (CLIA) after the landscaping and irrigation system has been installed.
  2. For new construction and rehabilitated landscape projects installed after December 1, 2015, at a minimum, audits shall include inspection, system tune-up, system test with distribution uniformity, reporting overspray or run off that causes overland flow, and preparation of an irrigation schedule, including configuring irrigation controllers with application rate, soil types, plant factors, slope, exposure and any other factors necessary for accurate programming.
  3. Landscape audits shall not be conducted by the person who designed the landscape or installed the landscape.

**3.15 GUARANTEE**

- A. Unconditionally guarantee the entire sprinkler system for material and installation, including settling of backfilled areas below grade for a minimum period of one year following the date of final acceptance of the work.
- B. Submit a guarantee on Contractor letterhead as follows:

We hereby guarantee that the sprinkler irrigation system we have furnished and installed is free from defects in materials and workmanship, and the work has been completed in accordance with the Drawings and specifications, ordinary wear and tear and unusual abuse, or neglect excepted, and that the work, materials and equipment as installed will fulfill the requirements of the guarantee included in the specifications. We agree to repair or replace any or all our work, together with any other adjacent work which may be displaced by doing so, that may prove to be defective in materials and installation within a period of one (1) year from date of acceptance of the below named project in the District, at no additional cost to the District. We shall make such repairs or replacement of the work within seven (7) calendar days of written notification by the District. When the immediate repair or replacement of the work is necessary to ensure the public safety and welfare, which would be endangered by continued usage of the facility, such circumstance will be deemed an operational emergency. In the event of such an emergency after the District contacts our firm and after authorizing 24 hours to initiate repairs, if we fail to initiate and diligently complete such repairs in a timely manner, the District may direct District forces to perform such functions as may be necessary to correct the work and immediately place the facility back in operations condition. If such procedure is implemented, we shall bear all expenses incurred by the District. In all cases, the judgment of the District shall be final in determining whether an operational emergency exists. In the event of our failure to make such repairs or replacements within the times specified after receipt of written notice from the District (other than an operational emergency), we authorize the District to proceed to have said repairs or replacements made at our expense and we will pay the costs and charges therefore upon demand.

PROJECT: \_\_\_\_\_

LOCATION: \_\_\_\_\_

SIGNED: \_\_\_\_\_

ADDRESS: \_\_\_\_\_

PHONE: \_\_\_\_\_



- C. If, within one year following acceptance of the work, settlement occurs and adjustments in pipes, valves and sprinkler heads, or paving is necessary to bring the system, sod or paving to the proper level of the permanent grades, as part of the work under this Contract, make all adjustments without extra cost to the District, including the complete restoration of all damaged planting, paving or other improvements of any kind.
- D. Should any operational difficulties in connection with the sprinkler system develop within the specified guarantee period which in the opinion of the District may be due to inferior material and/or workmanship, correct said difficulties immediately and to the satisfaction of the District and at no additional cost to the District, including all other damage caused by such defects.

### 3.16 CLEAN UP

- A. Upon completion of the work, and at the end of each day, smooth all ground surfaces; remove excess materials, rubbish, debris, etc., sweep adjacent streets, curbs, gutters and trails and remove construction equipment from the premises.

### 3.17 MAINTENANCE

- A. Properly and completely maintain the irrigation system. Maintain a balanced water program to ensure proper germination and growth until acceptance of the work. Plants which cannot be watered sufficiently with the irrigation system shall be watered by means of a hose.
- B. All controller shall have each station individually adjusted on a weekly basis. Program controller considering the application rate each area can receive. Operate the system on short intervals, with the cycle repeating later to reduce runoff. Program the irrigation system to operate between dusk and dawn (nightly) only and during non-windy hours.

### 3.18 TURNOVER ITEMS

- A. Controller Charts:
  - 1. The District must approve record prints before charts are prepared.
  - 2. Provide one controller chart (of the maximum size controller door will allow) for automatic controller. Chart shall show the area covered by controller.
  - 3. The chart shall be a reduced copy of the actual "record" print. In the event the controller sequence is not legible when the print is reduced, enlarged to a readable size.
  - 4. Color code the chart with a different color to show the area of coverage for each station.
  - 5. When completed and approved, hermetically seal the chart between two pieces of plastic, each piece being minimum 20 mils in thickness. Install the chart in the controller enclosure using weatherproof Velcro fasteners.
  - 6. Controller charts are to be completed prior to final observation.
- B. Operation and Maintenance Manuals: Within 10 calendar days prior to acceptance of construction, prepare and deliver to the District all required descriptive materials, properly prepared in two individually bound copies of the operation and maintenance manual. The manual shall describe the material installed and be in sufficient detail to permit operating personnel to understand, operate and maintain all equipment. Include spare parts lists and related manufacturer's information for each equipment item installed. Each complete, bound manual shall include the following information:
  - 1. Index sheet stating Contractor's address and telephone, including names and addresses of local manufacturer's representative.
  - 2. Complete operating and maintenance instructions on all major equipment.
- C. Materials to be furnished:

1. Supply as part of the contract the following spare parts:
  - a. 4 percent additional sprinkler head and bubblers of each type and spray pattern shown.
  - b. Two (2) wrenches for disassembly and adjustment of each type sprinkler head and bubbler installed.
  - c. One (1) QCV key with a  $\frac{3}{4}$  inch bronze hose bib, bent nose type with hand wheel.
  - d. "As-built" mylars from "record" prints.
  - e. Gate valve key.
2. Turnover the above spare parts to the District at the final observation.

**END OF SECTION**

**SECTION 32 9000**  
**LANDSCAPE PLANTING**

**PART 1 GENERAL**

**1.01 SUMMARY**

- A. Drawings and general provisions of the Contract, including General and Supplementary Conditions apply to this Section.
- B. Work Included:
  - 1. Furnish all plant materials.
  - 2. Furnish all labor, equipment and materials necessary for landscape planting installation and maintenance according to these Specifications.
- C. Related Work:
  - 1. Section 32 8000: Irrigation System
  - 2. Irrigation system shall be installed and operative before beginning planting operation. Contractor shall fully acquaint themselves with the existing conditions, particularly in reference to underground piping. Any damage caused by the Contractor to work of other trades shall be repaired by them at no cost to the District.

**1.02 COORDINATION**

- A. Coordinate work fully with all other trades involved. Coordinate with items of other trades to be furnished and set in place. Such portions of their work as is all or in part embedded, built-in, attached to, or supported by the work shall be executed by them in ample time that progress of the work is not delayed. Contractor shall be responsible for the proper installation of all items related to this section.
- B. Contractor shall coordinate with the Architect and fully acquaint themselves with the existing conditions particularly in reference to any existing underground piping. Any damage caused by the Contractor to work of other trades shall be repaired by them at no cost to the District.

**1.03 REFERENCE**

- A. Perform work in accordance with all applicable laws, codes and regulations, as required by the Architect.
- B. Reference to "Standard Specifications" shall mean the current Standard Specifications of the State of California, Business and Transportation Agency, Department of Transportation, CALTRANS.

**1.04 QUALITY ASSURANCE**

- A. Personnel:

All planting shall be performed by personnel familiar with planting procedures under the supervision of a qualified foreman.
- B. Codes and Standards:

Nursery stock shall meet the standards of the current edition of the "Agricultural Code of California" and the "Regulations of the Director of Agriculture Pertaining to Nursery Stock" as to grading and quality. They shall be true to type and name in accordance with "Standardized Plant Names, Second Edition."

- C. Substitutions:  
No substitutions shall be permitted without approval of the Architect. The District reserves the right to require the Contractor to replace at the Contractor's cost any plants which the Contractor has installed without the Architect's approval.
- D. Plants shall be subject to inspection and approval of the Architect at place of growth or upon delivery for conformity to specifications. Such approval shall not impair the right of inspection and rejection during progress of the work.

#### 1.05 SUBMITTALS

- A. Plant Certification:  
All plants must meet specifications of Federal, State and County laws requiring inspection for plant disease and insect infestations. Inspection certifications required by law shall accompany each shipment, invoice and order for stock.
- B. Plant Material:  
Contractor shall submit nursery sources for all plant material, clearly stating Botanical Name and container size. Additionally, Contractor shall submit photos from the sources and size specification including container size, height, diameter, and trunk caliper.
- C. Sod:  
Contractor shall submit written certificates stating quantity, type, composition, and source for all sod.
- D. Topsoil, Amendment and Fertilizer:  
Provide current, accurate analysis from an approved testing laboratory.
- E. Mycorrhizae planting backfill.
- F. Soils Fertility Laboratory Test Results for each planting area:
  - 1. Four (4) separate campus areas. Submit proposed locations to the Architect for approval prior to testing.
- G. Mulch as indicated on the Drawings.

#### 1.06 JOB CONDITIONS

- A. Delivery:
  - 1. Deliver fertilizer and amendments to site in original, unopened containers bearing manufacturer's guaranteed chemical analysis, name, trade mark and conformance to state law.
  - 2. Deliver plants with identification labels.
    - (a) Labels shall state correct name and size.
    - (b) Use durable, water-proof labels with water resistant ink that will remain legible for at least 60 days.

3. Protect plant materials during transport to prevent damage to rootball or desiccation of leaves.
4. Remove unacceptable plant materials immediately from job site.

A. Storage:

1. Contractor shall maintain the plant material properly between delivery and planting. This includes protection from animals and vandals; proper watering, and feeding when necessary.
2. Shade plants shall be stored in the shade, and sun plants shall be stored in the sun.

B. Timing:

Under no circumstances shall any work be performed when the temperature exceeds 90 degrees or is below 40 degrees. No planting shall be done with the soil saturated with water.

## PART 2 PRODUCTS

### 2.01 SOIL AMENDMENTS

- A. The following Top Soil, organic amendments, and fertilizer rates and quantities are to be used for bid basis only. Contractor shall arrange and pay for testing by an accredited soils laboratory of existing site soil after rough grading operations are complete, and shall amend the soils according to said laboratory's recommendations. The soils recommendations shall be considered a part of this specification.
- B. Topsoil: Provide topsoil as required to complete landscape work.
  1. Topsoil may include clean on-site material that has been previously stripped from the top 6 inches of original grade or acceptable import material (as applicable). Acceptable topsoil shall be free from "rocks" (rock, stones, rubble, clay clods, etc. over 1" in diameter), roots, toxins, and any other deleterious material per the discretion of the Architect. All import topsoil proposed for use shall be submitted to the Architect for review and acceptance prior to use. Submit samples and current soil fertility and structure analyses for approval by the Architect.
  2. Topsoil to be furnished shall be fertile and friable, possessing characteristics of representative productive soils on the site. It shall not contain toxic substances which may be harmful to plant growth. When herbicide contamination is suspected then a radish/rye grass growth trial must be performed. Consult with the Architect prior to decision to test. It shall be uniformly textured and free of all objectionable foreign materials, oil or chemicals which may be injurious to plant growth. Natural topsoil shall possess a pH factor between 5.5 and 7.5, a sodium absorption ratio (SAR) of less than 8, a boron concentration of the saturation extract of less than 1 ppm, and salinity of the saturation extract at 25 degrees C. of less than 4.0 millimhos per centimeter. Obtain topsoil from naturally well-drained sites where topsoil occurs in a depth of not less than four inches (4"); do not obtain from bogs or marshes.
- C. Organic Amendment:
  1. Physical Properties: A minimum of 90% of the material by weight shall pass a 1/2" screen. Material passing the 1/2" screen shall meet the following criteria:

% Passing	Sieve Designation
-----------	-------------------

- |        |            |        |
|--------|------------|--------|
| 85-100 | 9.51 mm    | 3/8"   |
| 50-80  | 2.38 mm    | No. 8  |
| 0-40   | 500 micron | No. 35 |
2. Source material: Fully composted organic green waste.
  3. Carbon and Nitrogen ratio: Maximum 35:1 if material is claimed to be nitrogen stabilized.
  4. Organic matter: Minimum 50% based on dry weight and determined by ash method. Minimum 270 lbs. organic matter per cubic yard of compost.
  5. Iron content: Minimum 0.08% dilute acid soluble iron based on dry weight; iron treated.
  6. Salinity (ECe): 4.5 dS/m maximum @ 25 degrees C. as determined in a saturation extract.
  7. Reaction (pH): Minimum: 5.5, Maximum: 8.0 as determined in saturated paste.
  8. Moisture content 35% - 60%.
  9. Contaminants: the compost shall be free of contaminants such as glass, metal and plastic.
  10. Maturity: Shall exhibit visible characteristics of maturity, including: dark brown to black color. Acceptable odor: moldy/musty, soil like, or none. Unacceptable odor: sour, ammonia or putrid.
  11. Appearance: Identifiable wood pieces are acceptable, but the balance of the material should be soil like, without recognizable leaves.

D. Fertilizer:

1. Fertilizer shall be a commercial inorganic fertilizer in the granular or pelleted form. Fertilizer shall be delivered to the site in containers labeled in accordance with the applicable State of California regulations, bearing the warranty of the producer or the grade furnished, and shall be uniform in composition, dry and free-flowing.
2. Planting Areas:
  - (a) 6N-20P-20K, and 16-6-8, pelleted type.
  - (b) Sulphate - sulphur
  - (c) Lime for pH adjustment of moderately acid soil
  - (d) Starting one (1) month after planting, on a monthly basis, 21N-0P-0K Ammonium sulfate. 5 lbs. per 1,000 square feet.

E. Mycorrhizae Planting Backfill:

1. MycoApply Endo/Ecto Plus, available from Mycorrhizal Applications, Inc., [www.mycorrhizae.com](http://www.mycorrhizae.com).

## 2.02 CONTAINER PLANTS

- A. All plant materials shall be nursery grown in accordance with the best known horticultural practices and under climatic conditions similar to those in the locality of the project.
- B. Plants shall be vigorous and shall have a normal habit of growth. Plants shall be free of damage by insects, pests, diseases or wind; burns from insecticides or fertilizer; and stunted growth due to lack of water, lack of food, diseases or other causes. Plants shall be in conformity with the sizes shown on the Drawings.
- C. Trees:
  1. Unless otherwise specified, tree trunks shall be straight with leader intact, undamaged and uncut. All old abrasions and cuts are acceptable only when completely callused over.

D. Quantities:

1. Quantities necessary to complete the work as shown on the Drawings shall be furnished.

E. Root Systems:

1. All trees shall have a normal root system. No plants with roots that have encircled themselves will be accepted. In case of any unsatisfactory root system, a total group of plants may be rejected.

**2.03 TURF**

A. Sod:

1. Sod shall be as specified on the Drawings.

**PART 3 INSTALLATION**

**3.01 SURFACE CONDITIONS**

A. Inspections by the Landscape Contractor:

1. Prior to all work in this section, verify grades and carefully inspect the installed work of all other trades. Verify that all such work is complete to the point where the installation may properly commence.
2. All planting areas shall contain a minimum of eight (8) inches of acceptable topsoil. As applicable and where needed, only previously acceptable topsoil shall be installed.
3. Inspect plant materials for injury, insect infestations and proper pruning.
4. Landscape Contractor shall receive site graded to plus or minus one-tenth of a foot (0.10') of finish grades shown on the Drawings. Allow for depth of soil amendments and mulch in determining the difference between finished subgrade in groundcover and shrub beds. Verify that subgrades are not compacted.
5. Landscape Contractor shall over excavate planting beds along the perimeter of lime treated areas to remove excess lime that was added for construction. Refer to geotechnical report for required overbuild and depth of lime to determine extent of removal. Provide new topsoil in these planting areas.
6. Contaminated Soil:
  - (a) Do not perform any soil preparation work in areas where soil is contaminated with cement, plaster, paint or other construction debris. Bring such areas to the attention of the Architect and do not proceed until the contaminated soil is removed and replaced.
  - (b) Contaminated soil shall be removed to full depth of contaminants with a minimum depth of 12 inches and replaced with acceptable topsoil.
7. Moisture Content: Soil shall not be worked when moisture content is so great that excessive compaction will occur, nor when it is so dry that dust will form in the air or that clods will not break readily. Water shall be applied, if necessary, to bring soil to an optimum moisture content for tilling and planting.
8. Soil Loosening: Soil in all planting areas (only) shall be ripped or cultivated to the depths specified below. Water shall be added and ripping or cultivating shall be continued until the entire specified depth is loose and friable. All debris, pavement, concrete, and rocks over 1 inch in diameter shall be removed to the specified depth and shall be removed from the site and disposed of properly.

- (a) Slopes 2½ horizontal to 1 vertical and steeper: No loosening required.
  - (b) All other areas to be planted: 12 inches deep.
9. Weed Control and removal:
  - (a) Remove all weeds and other debris prior to any soil preparation or grading work. Weeds and debris shall be disposed of off the site properly.
  - (b) Grow and Kill: After grading finish is complete, apply water in sufficient quantity over a minimum period of 14 days to germinate weed seeds. When weeds have germinated, kill them and remove them in a manner acceptable to the District and that will not have a detrimental residual effect on the growth and vigor of the landscape planting work. Provide temporary irrigation as required to apply the water.
10. In the event of discrepancy, immediately notify the Architect. Do not proceed with this installation in areas of discrepancies until all such discrepancies have been fully resolved.

### 3.02 SOIL PREPARATION

- A. In the areas designated for landscaping on the Drawings except for bioretention areas and within tree protection zones, Contractor shall, prior to placing imported material, replacing existing topsoil before doing any planting, verify that the areas are clear and free of weeds, roots, debris, rocks and underground obstructions, and construction debris to a depth acceptable for planting. Scarify the subgrade to a four inch (4") minimum depth prior to spreading topsoil. Finished grades shall be approved by the Architect prior to commencing soil preparation and planting operations.
- B. Cultivation and Placement of Amendment:
  1. In turf areas within tree protection zones, mow existing turf to one inch (1") in height, use a steel rake to remove clippings and scarify soil, and topdress with a minimum of one inch (1") of amended topsoil to provide a smooth substrate for over-seeding within the area of exposed surface roots. Place amended topsoil as required to conform to finish grade elevations shown on the Grading Plan. All work in the proximity of existing trees to remain shall follow the Tree Protection Specifications on the Drawings. Apply fertilizer in accordance with soils test results.
  2. In planting areas except for bioretention areas and within tree protection zones, cultivate soil to a depth of eight inches (8"). Prior to planting, incorporate six (6) cubic yards per 1,000 square feet of nitrified fir bark, and the following fertilizers, per 1,000 square feet: 30lbs. 6N-20P-20K to a depth of six inches (6").
- C. Finish Preparation:
  1. After approval of amendment and fertilizer applications by the Architect, incorporate into the top six inches (6") of soil by repeated rotary-hoe cultivation except within tree protection zones.
  2. When rough grading and soil conditioning has been completed, all planting areas shall be smooth graded, ready for placement of plant materials and for seeding/sod. Grading shall be done when soil is at optimum moisture content for working.
  3. Finished grades shown on the Civil Drawings are given in feet and decimals of feet. Slope uniformly between given spot elevations. Planting areas shall be true to grade within one inch when tested in any direction with a 10 foot straightedge.
  4. Grades not otherwise indicated shall be uniform levels or slopes between points where elevations are given or between points established by walks, paving, curbs or catch



basins. Finished grades shall be smooth even and on a uniform plane with no abrupt change of surface. Minor adjustments of finish grades shall be made at the direction of the Architect if required.

5. All grades shall provide for natural runoff of water without low spots or pockets. Flow line grades shall be accurately set and shall not be less than 2 percent gradient wherever possible unless otherwise indicated on the Drawings.
6. Tops and toes of all slopes shall be rounded to produce a gradual and natural-appearing transition between relatively level areas and slopes.
7. Roll to compact amended soil to not more than 85% compaction.
8. Finish out to a smooth, even surface conforming to established grades after settlement. Rake immediately prior to planting.
9. If rain is likely between completion of soil preparation and planting, precaution shall be taken to prevent erosion of the soil.

### 3.03 CONTAINER PLANTS

#### A. Preparation:

1. Place plants in containers in the locations indicated on the Drawings and obtain the approval of the Architect before digging. Maintain plants as required for optimal condition until approved for installation.
2. The Contractor shall protect all utilities, vegetation and structures during work.

#### B. Excavation:

1. All plant pits shall be dug circular in outline and with vertical walls. The sides and bottoms of all planting pits shall be thoroughly scarified.
2. Holes for fifteen (15) gallon size plants or larger: twenty-four inches (24") wider than the can or rootball.
3. After pits are dug, break sides to open wall of pit for root penetration and loosen bottom of pit to a depth of three inches (3"). Construct a foot tamped mound in bottom of pit to support plant at proper level.
4. Following excavation of planting holes and prior to placing backfill, fill planting hole with water to a depth of 6", and allow water to percolate into existing soil for 24 hours. Any planting holes not drained within 24 hours shall have drainage holes drilled to a depth that allows planting hole to drain or install subdrain from planting pit to storm drain system as directed by the Architect. After drilling drainage hole or installing subdrain, refill with water and repeat process above as directed by the Architect.

#### C. Plants in Containers:

1. Plants shall be removed carefully from their containers after the containers have been cut on two (2) sides minimum; fifteen (15) gallon containers shall be opened in three (3) places.
2. After removing plant material from its container, stimulate root growth by making four (4) or five (5) vertical cuts, one inch (1") deep around the circumference of the rootball.
3. Do not lift or handle plants by the top, stems or trunk at any time. All plants shall be lifted in such a manner that the rootball is supported from the underside.
4. The Contractor shall check all plants for adequate root systems. When the root system is defective, he shall remove deficient plants from the site and replace them with new ones with adequate root system.

D. Planting:

1. Center plant in pit or trench over tamped mound.
2. Face for best effect.
3. Set plant plumb and hold rigidly in position.
4. All plants shall be set in the ground so that the rootball will be flush with the finish grade. All plants that settle below the finish grade within thirty (30) days of acceptance of the work shall be replanted in the proper position. In case a total section of planting area settles, the Contractor shall lift the plants, import additional soil mix, regrade and replant, at no additional cost to the District.
5. Use amended soil mix only for backfill. Backfill pit with soil mix in nine inch (9") layers and water each layer thoroughly to settle soil. The filled pit shall be flush with surrounding grade when complete.
  - (a) In the top 1" of the plant hole, mix Mycorrhizae planting backfill with the plant backfill. Evenly distribute the Mycorrhizae and place as close to rootball as possible at the following rates.
    - 4" pot or Liner: 1 teaspoon
    - # 1 gallon: 1 tablespoon
    - # 5 gallon: 4 tablespoons
    - # 15 gallon: 6 tablespoons
    - 24" box: 8 tablespoons
6. When the plant pit has been approximately one-half (1/2) filled, place planting tablets according to the manufacturer's schedule.
  - (a) Planting areas shall be hand raked to remove all clods, weeds, roots, debris, and rocks 1-inch in diameter and larger.
7. Dispose of excess excavated soil (if any) on the site at no additional cost to the District.

**3.04 PRUNING**

- A. Pruning shall be performed as required to maintain a natural appearance, promote healthy and vigorous growth and eliminate diseased or damaged growth.
- B. Trees shall be pruned to thin crown and avoid wind damage, eliminate narrow V-shaped branch forks that lack strength, eliminate sucker growth and maintain a radial branching pattern to avoid crossing branches.
- C. Under no circumstances will stripping of lower branches ("raising-up") of young trees be permitted. Lower branches shall be retained in a "tipped back" or pinched condition with as much foliage as possible to promote caliper trunk growth (tapered trunk).
- D. Major pruning of trees to compensate for root loss or for aesthetic reasons shall be done only with approval of the Architect.
- E. All pruning shall be made flush to lateral branches, buds or trunk. "Stubbing" will not be permitted.
- F. Damage: All cuts over one inch (1") resulting from pruning or wind breakage shall be inspected periodically for insect infestation or disease.

**3.05 TURF**

- A. Turf shall be as indicated on the Drawings.

- B. After soil preparation, turf areas shall be graded to drain and shall be smooth and uniform prior to placing sod. Areas shall be hand raked to remove all clods, weeds, roots, debris, and rocks 1-inch in diameter and larger. After fine grading, rolling, and settlement of the soil, seed or sod shall be placed as shown on the Drawings.
- C. Grading in turf areas that has been established under work of another Section and/or Contract shall be maintained in a true, even condition, equal to when said grades were previously approved by the Architect.
- D. Seed shall be broadcast at the specified rate of application.
- E. Sod shall be placed so that the ends of adjacent strips of sod are staggered a minimum of 2 feet. Edges and ends of sod shall be placed firmly against adjacent sod and against sidewalks, concrete headers, header boards, and other paved borders and surfaced areas. Where no edging is present, Contractor shall cut edge of sod in line indicated on the Drawings and backfill edges with soil. Edges of sod rolls shall not be exposed.
- F. After placement of the sod, the entire sodded area shall be lightly rolled to eliminate air pockets and to ensure close contact with the soil.
- G. Turf areas shall be watered so that the soil is moistened to a minimum depth of 4 inches. Turf areas shall not be allowed to dry out for a minimum of 14 days.

### **3.06 PROTECTION**

- A. Protect all planted areas and plants against trespassing and damage at all times. If any plants are damaged, replace as directed by the Architect with no additional cost to the District.

### **3.07 CLEAN UP**

- A. Upon completion of planting, all cans, boxes and other debris that is a part of the planting operation shall be removed from the site.
- B. All pavements shall be washed off, and site shall be left in an absolutely clean condition. All planting areas shall be cultivated and weed free before final inspection. Clean-up operations shall take place throughout the course of work so that walks and drives are clean at all times.

### **3.09 INSPECTIONS**

- A. Notification: The Contractor shall notify the Architect a minimum of 72 hours before requiring a visit by the Architect.
- B. Check Points: The following shall be considered check points and the Contractor shall only proceed with the work after the Architect has visited the site and determined that the work is proceeding satisfactorily.
  - 1. Completion of rough grading in planting areas.
  - 2. After placement of topsoil, soil amendment and fine grading before planting, seeding or sodding.
  - 3. Layout of plant material. All plant material in the planting area shall be placed in the configuration shown on the Drawings prior to plant pit excavation.
  - 4. Maintenance period shall not start until all construction for the entire project is complete.

5. A check visit shall be made to begin the maintenance period. At this time the Contractor shall have completed all phases of the Drawings and Specifications. Any discrepancies shall be noted at that time and the Contractor shall make appropriate corrections before beginning the maintenance period.

### 3.10 MAINTENANCE

- A. Contractor shall furnish all labor, material, equipment and services required to maintain the landscape in a healthy and attractive condition for a period of ninety (90) calendar days.
- B. Maintenance shall include fertilization, watering, insect and disease control, weed control (hand or spray), mowing, pruning, restaking, continual checking, adjusting, programming and making all necessary repairs to the automatic irrigation system, cleaning of pavement, replenishment of bark mulch, and weekly trash removal from all project site areas. All chemical use shall conform to District's standards for application and notification.
- C. No later than two (2) calendar weeks prior to the end of the maintenance period, the Contractor shall request in writing a review of the work by the Architect. When, upon review, the Architect finds all project work to be complete, the plant material to be in a healthy condition and all landscape areas to be weed-free and in a neat, orderly condition, then written acceptance of work shall be given by the Architect. When approval and acceptance of the work is not given, the Architect shall prepare a "construction punch list" of items to be completed before acceptance of the work is given. Acceptance shall only then be given upon verification by the Architect that the punch list items have been completed. Maintenance period shall only commence after "construction punch list" items have been completed and approved. "Construction punch list" items shall be completed within the specified construction period to avoid liquidated damages and extension of maintenance period.
  1. All plant material shall be live, healthy, undamaged, vigorous and free from infestations.
  2. All turf areas shall be completely covered at the time of final acceptance, leaving no bare spots. Sod shall be free of all weeds (broadleaf and grass weeds).
  3. Planting areas shall be free of all weeds.
  4. Nursery stakes shall be removed from trees.
- D. The Contractor's maintenance period will be extended when the provisions required within the plans and specifications are not full complete and accepted by the Architect.
- E. Watering:
  1. All plants shall be kept watered as often as it is necessary to keep them in optimum, vigorous growth. Watering shall be done preferably during the early morning hours.
  2. Water shall be controlled so that there will be no excessive run-off, ponding or overwatering.
  3. Root Growth: Periodically the Contractor shall check the progress of the root growth within the back fill area. As the root growth increases beyond the root ball, the frequency of watering shall be reduced so that the roots are encouraged to grow to a lower soil depth. Watering then shall be less frequent, but

applications shall be very slow and the Contractor shall assure that water does penetrate to the depth of the former plant pit.

F. Mowing

1. Winter: Mow grass weekly to 1-1/2" when it reaches height of 2-1/2". Remove no more than 1/3 of the grass blade at each mowing event
2. Other seasons: Mow grass weekly to 2-1/2" when it reaches a height of 3-1/2". Remove no more than 1/3 of the grass blade at each mowing event
3. Biofiltration Sod and Native Mow Free Sod shall be mowed or trimmed with a line trimmer to remove dead growth or remove seed heads as approved by the Architect.

G. Spraying:

1. Trees shall be inspected at least two (2) times a month during the growing period to determine the need for spraying to control insect damage, fungus development or any other disease that might be attacking the plants. Plants shall be sprayed with a broad spectrum material that will control the specific pest and any other pests that might normally be anticipated during that part of the season. Preventative spraying shall be done only with the approval of the District.
2. Operators of spray equipment shall take all reasonable precautions to protect themselves, other people and buildings from spray. The Contractor shall publicly notice the use of herbicides and have all permits and licenses required for such an operation. Where applicable, dormant spray shall be applied to shrubs and trees during the winter period.
3. All equipment shall be properly washed before and after use. No spraying shall take place without proper public noticing procedures or during windy or gusty days.

H. Staking and Guying: Stakes and guys shall be inspected a minimum of two (2) times a month to assure that the wires and ties are tight and no damage has occurred to the tree trunk or branches. Contractor shall restake and guy trees as directed by the Architect.

I. Weed Control:

1. Weeds shall be kept under control by hand removal. Herbicides shall only be used when approved by the Architect. Weed all areas at an interval of not more than ten (10) days.
2. Pre-emergent herbicide shall be applied to all tree and turf areas including plant basins. Chemicals used are to be in written chemical control program prepared by a licensed pest control advisor and approved by the Architect. Apply prior to any mulching.
3. All equipment used for herbicides shall be properly cleaned before it is used on this project. Herbicides shall be applied at temperatures recommended by the manufacturers. Herbicides shall not be used during windy or gusty days. All possible precautions shall be taken to protect vegetation which is susceptible to damage from the particular herbicides to be used.
4. The bases of all plants shall be kept completely free of weeds. Periodically, the base of the trees and shrubs shall be cultivated in order to allow better

penetration of water, but such cultivation shall be carefully done in order not to destroy surface roots.

- J. Fertilization: Topdress all areas at one (1) month intervals from time of planting with fertilizer of same composition and at same rate as at time of planting.
- K. Litter: The Contractor shall remove promptly after pruning, trimming and weeding or other work required under the contract, all debris generated by his performance of the work. Walkways, driveways and paved areas shall be vacuumed clean with suitable equipment immediately after working in these areas. All areas covered by this contract shall be kept free of debris and litter.
- L. Pruning: Prune as necessary to remove injured twigs, branches, dead wood and suckers.

### **3.11 GUARANTEE AND REPLACEMENT**

- A. Guarantee period shall be extended for a period of one (1) year from the date of written acceptance.
- B. All plants shall be guaranteed to be alive and healthy as determined by the Architect at the end of the guarantee period.
- C. The Contractor shall replace within two (2) weeks of notice and in accordance with the Drawings and Specifications throughout the guarantee period, any plants that die, or in opinion of the Architect, are in an unhealthy or unsightly condition, and or have lost their natural shape due to dead branches, excessive pruning, inadequate or improper maintenance, or any other causes due to the Contractor's negligence. Any plant that shows 25% defoliation shall be considered unhealthy.

END OF SECTION

**SECTION 31 3100**  
**SITE SANITARY SEWERAGE**

**1. GENERAL**

**1.1 RELATED DOCUMENTS**

- A. Drawings and general provisions of the Contract, including General and Supplementary Conditions and Division 1 Specification Sections, apply to this Section.

**1.2 SUMMARY**

- A. This Section includes gravity-flow, non-pressure sanitary sewerage outside buildings, including the following components:
1. Cleanouts.
  2. Manholes.
- B. Related Sections include:
1. Section 33 1100 "Site Water Distribution" for underground water lines outside buildings.
  2. Section 31 2333 "Trenching and Backfill" for trenching and backfilling for underground sanitary sewer lines, and detectable warning tapes.
  3. Section 33 4000 "Site Storm Drainage" for underground storm drain lines outside buildings.
  4. Section for sanitary sewer lines within and below buildings.

**1.3 DEFINITIONS**

- A. DN: Dimension Nominal.
- B. NPS: Nominal Pipe Size.
- C. PVC: Polyvinyl chloride plastic.
- D. SDR: Standard Dimension Ratio, derived by dividing the outside diameter of the pipe by the pipe wall thickness.

**1.4 SUBMITTALS**

- A. Product Data: For each type of product indicated, including the following:
1. Piping and related specialties.
  2. Cleanouts.
- B. Coordination Drawings: Show pipe sizes, locations, and elevations. Show other piping in the vicinity and clearances from sewerage system piping. Indicate interface and spatial relationship between manholes, cleanouts, piping, and proximate structures.

- C. Field quality-control test reports.
- D. Record drawings of installed sanitary sewerage lines and appurtenances in accordance with Division 1 Section for project closeout requirements.
  - 1. Locate and dimension work with reference to permanent landmarks. Indicate materials and sizes of all components.

**1.5 DELIVERY, STORAGE, AND HANDLING**

- A. Deliver piping with factory-applied end caps. Maintain end caps through shipping, storage, and handling to prevent pipe-end damage and to prevent entrance of dirt, debris, and moisture.
- B. Do not store plastic pipe and fittings in direct sunlight.
- C. Protect pipe, pipe fittings, and seals from dirt and damage.

**1.6 PROJECT CONDITIONS**

- A. Interruption of Existing Sanitary Sewerage Service: Do not interrupt service to facilities occupied by Owner or others unless permitted under the following conditions and then only after arranging to provide temporary service according to requirements indicated:
  - 1. Notify Architect no fewer than seven days in advance of proposed interruption of service.
  - 2. Do not proceed with interruption of service without Architect's written permission.
- B. Information shown regarding locations of existing utilities is based upon available records and data, but shall be regarded as approximate, only. Make minor deviations necessary to conform to actual locations and conditions without extra cost. Verify location and elevation of utilities prior to commencement of excavation.
  - 1. Exercise extreme care in excavating near existing utilities. Contractor is responsible for damage to existing utilities.



## 1.7 COORDINATION

- A. Coordinate connection in public right of way with City of Brentwood.
- B. Coordinate placement of cleanouts and manholes with layout of pavement joints and patterns. Refer to Drawings for layout.
- C. Coordinate crossings with other underground utilities.
- D. Coordinate with locations of building connections.

## 2. PRODUCTS

### 2.1 PIPING MATERIALS

- A. Refer to Part 3 "Piping Applications" Article for applications of pipe, fitting, and joining materials.

### 2.2 PVC PIPE AND FITTINGS

- A. Polyvinyl chloride pipe (PVC) solid wall pipe with fittings for diameter sizes of 3-in through 8-in shall be type PSM SDR-35, ASTM 3034. Couplings and joints shall meet the requirements in ASTM D3212.

### 2.3 CLEANOUTS

- B. Pipe for cleanout shall be of the same size and material as sanitary sewer line. Refer to Detail shown on the plans.
- C. Frame and cover shall be manufactured of cast iron conforming to ASTM A-48-class 30.
  - 1. Frame and cover shall be HS20-44 rated and shall be coated with bituminous material.

### 2.4 MANHOLES: Precast reinforced concrete manhole in conformance with ASTM C-478. Manhole base to be precast or cast-in-place. Refer to City of Brentwood standard drawing SS-2.

- A. Size: 48" I.D. with precast reinforced concentric concrete cone.
- B. Lid inscribed with the words "SANITARY SEWER".
- C. All joints shall be set on full mortared bed and banded with mortar on both interior and exterior surfaces.

### **3. EXECUTION**

#### **3.1 EARTHWORK**

- A. Refer to Section 31 2000 "Earthwork" for excavation, trenching, and backfilling.

#### **3.2 PREPARATION**

- A. Where connecting to existing sewer lines, verify existing line is free-draining prior to making connection. If required, clean existing line to achieve free-draining condition.

#### **3.3 PIPING APPLICATIONS**

- A. Gravity-Flow, Non-pressure Sewer Piping: Use the following pipe materials:
  - 1. NPS 3 (DN 80) to NPS 12 (DN 300): PVC sewer pipe and fittings, gaskets, and gasketed joints.

#### **3.4 PIPING INSTALLATION**

- A. General Locations and Arrangements: Drawing plans and details indicate general location and arrangement of underground sanitary sewerage piping. Location and arrangement of piping layout take design considerations into account. Install piping as indicated, to extent practical. Where specific installation is not indicated, follow piping manufacturer's written instructions.
- B. Install piping at low point, true to grades and alignment indicated with unbroken continuity of invert. Place bell ends of piping facing upstream. Install gaskets, seals, sleeves, and couplings according to manufacturer's written instructions for use of lubricants, cements, and other installation requirements.
- C. Install piping free of sags and bends.
- D. Use fittings for changes in direction and branch connections unless indicated otherwise.
- E. Install proper size increasers, reducers, and couplings where different sizes or materials of pipes and fittings are connected. Reducing size of piping in direction of flow is prohibited.
- F. Tunneling: Install pipe under streets or other obstructions that cannot be disturbed by tunneling, jacking, or a combination of both.

- G. Install gravity-flow, non-pressure drainage piping according to the following:
  - 1. Install piping pitched down in direction of flow, at slope indicated, but in no case less than 0.35 percent.
  - 2. Install piping at elevations and inverts indicated, but in no case with less than 36-inch cover.
  - 3. Install PVC sewer piping according to ASTM D 2321 and ASTM F 1668.
- H. Clear interior of piping of dirt and superfluous material as work progresses. Maintain swab or drag in piping, and pull past each joint as it is completed. Place plug in end of incomplete piping at end of day and when work stops.

### **3.5 PIPE JOINT CONSTRUCTION**

- A. Join gravity-flow, non-pressure drainage piping according to the following:
  - 1. Join PVC sewer piping according to ASTM D 2321 and ASTM D 3034 for elastomeric-seal joints or ASTM D 3034 for elastomeric gasket joints.
  - 2. Join dissimilar pipe materials with pressure-type couplings.

### **3.6 CLEANOUT INSTALLATION**

- A. Install cleanouts and riser extension from sanitary sewerage pipe to cleanout at grade. Use cast-iron soil pipe fittings in sanitary sewerage pipes at branches for cleanouts and cast-iron soil pipe for riser extensions to cleanouts. Install piping so cleanouts open in direction of flow in sewer pipe.
- B. Set cleanout frames and covers in earth in cast-in-place concrete block, as detailed on Drawings. Set with top of concrete flush with adjacent paving material, or, if occurring in planted or soil area, 1-inch above surrounding finish grade.

### **3.7 MANHOLE INSTALLATION**

- A. Install manholes to grade specified on plans. Manhole base to be precast or cast-in-place concrete.

### **3.8 CONNECTIONS**

- A. Connect non-pressure, gravity-flow sanitary sewerage piping to building sanitary sewer lines, as indicated on Drawings.
  - 1. Refer to Division 15 Section for plumbing sanitary sewer lines occurring inside and below buildings.

- B. Make connections to existing sanitary sewer piping.
  - 1. Use commercially manufactured wye fittings for piping branch connections. Remove section of existing pipe; install wye fitting into existing piping; and encase entire wye fitting, plus six-inch overlap, with not less than six inches of concrete with 28-day compressive strength of 3000 psi.
  - 2. Protect existing piping to prevent concrete or debris from entering while making tap connections. Remove debris or other extraneous material that may accumulate.

### 3.9 IDENTIFICATION

- A. Refer to 31 2333 "Trenching and Backfill" for continuous underground warning tape installed over underground sanitary sewer piping.

### 3.10 FIELD QUALITY CONTROL

- A. Inspect interior of piping to determine whether line displacement or other damage has occurred. Inspect after approximately 24 inches of backfill is in place, and again at completion of Project.
  - 1. Submit separate report for each system inspection.
  - 2. Defects requiring correction include the following:
    - (a) Alignment: Less than full diameter of inside of pipe is visible between structures.
    - (b) Deflection: Flexible piping with deflection that prevents passage of ball or cylinder of size not less than 92.5 percent of piping diameter.
    - (c) Crushed, broken, cracked, or otherwise damaged piping.
    - (d) Infiltration: Water leakage into piping.
    - (e) Exfiltration: Water leakage from or around piping.
  - 3. Replace defective piping using new materials, and repeat inspections until defects are within allowances specified.
  - 4. Re-inspect and repeat procedure until results are satisfactory.

- B. Test new piping systems, and parts of existing systems that have been altered, extended, or repaired, for leaks and defects.
  - 1. Do not enclose, cover, or put into service before inspection and approval.
  - 2. Test completed piping systems according to authorities having jurisdiction.
  - 3. Schedule tests and inspections by authorities having jurisdiction with at least one working day's advance notice.
  - 4. Submit separate report for each test.
- C. Leaks constitute defects that must be repaired.
- D. Replace leaking piping using new materials.

**3.11 CLEANING**

- A. Clean interior of piping of dirt and superfluous materials. Flush with potable water.
- B. Where connecting to existing sewer lines, clean existing line from point-of-connection to nearest downstream manhole or catch basin.

**END OF SECTION 31 3100**

## SECTION 33 4000

### SITE STORM DRAINAGE

#### **1. GENERAL**

##### **1.1 RELATED DOCUMENTS**

- A. Drawings and general provisions of the Contract, including General and Supplementary Conditions and Division 1 Specification Sections, apply to this Section.

##### **1.2 SUMMARY**

- A. This Section includes gravity-flow, non-pressure storm drain piping outside the building, and the following components:
  - 1. Drainage Inlets.
  - 2. Catch Basins
  - 3. Cleanouts
  - 4. Subdrain Systems
  - 5. Bioretention Systems
- B. Related Sections include:
  - 1. Section 31 2333 "Trenching and Backfill" for trenching and backfilling for underground storm drain lines, and detectable warning tapes.

##### **1.3 DEFINITIONS**

- A. DN: Dimension Nominal.
- B. NPS: Nominal Pipe Size.
- C. PVC: Polyvinyl chloride plastic.
- D. HDPE: High-Density Polyethylene.
- E. RCP: Reinforced Concrete Pipe
- F. SDR: Standard Dimension Ratio, derived by dividing the outside diameter of the pipe by the pipe wall thickness.

1.4 **SUBMITTALS**

- A. Product Data: For the following:
  - 1. Piping and related specialties.
  - 2. Drainage Inlets.
  - 3. Catch Basins.
  - 4. Cleanouts.
  - 5. Subdrain Systems.
- B. Shop Drawings: For the following:
  - 1. Drains and Inlets: Include plans, elevations, sections, details, and frames, covers, and grates.
- C. Coordination Drawings: Show pipe sizes, locations, and elevations. Show other piping in the vicinity and clearances from storm drainage system piping. Indicate interface and spatial relationship between manholes, piping, and proximate structures.
- D. Field quality-control test reports.
- E. Record drawings of installed storm drainage lines and appurtenances in accordance Division 1 Section for project closeout requirements.
  - 1. Locate and dimension work with reference to permanent landmarks. Indicate materials and sizes of all components.

1.5 **DELIVERY, STORAGE, AND HANDLING**

- A. Deliver piping with factory-applied end caps. Maintain end caps through shipping, storage, and handling to prevent pipe-end damage and to prevent entrance of dirt, debris, and moisture.
- B. Protect pipe, pipe fittings, and seals from dirt and damage.
- C. Do not store plastic manholes, pipe, and fittings in direct sunlight.
- D. Handle catch basins and drainage inlets according to manufacturer's written rigging instructions.

## 1.6 PROJECT CONDITIONS

- A. Interruption of Existing Storm Drainage Service: Do not interrupt service to facilities occupied by Owner or others unless permitted under the following conditions and then only after arranging to provide temporary service according to requirements indicated:
  - 1. Notify Architect no fewer than five working days in advance of proposed interruption of service.
  - 2. Do not proceed with interruption of service without Architect's written permission.
- B. Information shown regarding locations of existing utilities is based upon available records and data, but shall be regarded as approximate, only. Make minor deviations necessary to conform to actual locations and conditions without extra cost. Verify location and elevation of utilities prior to commencement of excavation.
  - 1. Exercise extreme care in excavating near existing utilities. Contractor is responsible for damage to existing utilities.

## 1.7 COORDINATION

- A. Coordinate connection in public right of way with City of Brentwood.
- B. Coordinate placement of structures with layout of pavement joints and patterns. Refer to Drawings for layout.
- C. Coordinate crossings with other underground utilities.
- D. Coordinate with locations of building down spouts.

## 2. PRODUCTS

### 2.1 PIPING MATERIALS

- A. HDPE Pipe and Fitting.
  - 1. HDPE shall be DR-11 and conform to ASTM F714 and AASHTO designation M-294.
- B. PVC Pipe and Fittings
  - 1. PVC Sewer Pipe and Fittings, NPS 15 (DN 375) and Smaller: ASTM D 3034, SDR 26, with bell-and-spigot ends for gasketed joints with ASTM F477, elastomeric seals. Couplings and joints shall meet the requirements in ASTM D3212.
- C. RDP and Fittings
  - 1. Pipes specified on plans as RCP shall be Class IV, Type II Portland Cement conforming to ASTM C76 and C150.



## 2.2 DRAINAGE INLETS (DI)

- A. Precast reinforced concrete square drain box with galvanized steel frame for grate; galvanized welded steel bar grate with hold-down bolts.
  - 1. Products: Subject to compliance with requirements, provide one of the following:
    - (a) Central Precast Products: Refer to structure types and sizes specified on plans.
    - (b) Equal product in accordance with Division 1 requirements for product substitutions.
  - 2. Joint Sealants: ASTM C 990, bitumen or butyl rubber.

## 2.3 AREA DRAINS (AD)

- A. Refer to Area Drain detail shown on plans.
- B. Area Drains to be provided at locations shown on plans.
- C. Area Drain cover to be one of the following:
  - 1. NDS 9" Catch Basin with Model 980 Inlet Top
  - 2. Equal product in accordance with Division 1 requirements for product substitutions.

## 2.4 CLEANOUTS (CO)

- A. Refer to Storm Drain Cleanout detail shown on plans.
- B. Storm drain cleanouts to be provided at all locations rainwater leaders have a change in direction, not including the connection to the main.
- C. Riser pipe to be 4" PVC with plug.

## 2.5 SUBDRAIN SYSTEMS

- A. Provide 6" ADS N-12 perforated drain pipe with smooth interior walls and holes down, per Subdrain detail shown on plans.
- B. Wrap pipe in filter fabric sock and connect to storm drain system.
- C. Pipe to be laid in small groove on class 2 permeable material per Caltrans Standard Specifications.

## 2.6 CONCRETE

- A. General: Cast-in-place concrete according to ACI 318, ACI 350R, and the following:
  - 1. Cement: ASTM C 150, Type II.
  - 2. Fine Aggregate: ASTM C 33, sand.
  - 3. Coarse Aggregate: ASTM C 33, crushed gravel.
  - 4. Water: Potable.

- B. Portland Cement Design Mix: 4000 psi minimum, with 0.45 maximum water-cementitious materials ratio.
- C. Reinforcement:
  - 1. Reinforcement Fabric: ASTM A 185, steel, welded wire fabric, plain.
  - 2. Reinforcement Bars: ASTM A 615, Grade 60, deformed steel.

### **2.7 BIO-TREATMENT SOIL**

- A. Provide regional water board's approved soil mix specifications. Refer to the San Francisco Bay Water Board's website link:  
[https://www.waterboards.ca.gov/sanfranciscobay/water\\_issues/programs/stormwater/MRP/C3.html](https://www.waterboards.ca.gov/sanfranciscobay/water_issues/programs/stormwater/MRP/C3.html)

## **3. EXECUTION**

### **3.1 EARTHWORK**

- A. Refer to Section 31 2000 "Earthwork" for excavation, trenching, and backfilling.

### **3.2 PREPARATION**

- A. Where connecting to existing drain lines, verify existing line is free-draining prior to making connection. If required, clean existing line to achieve free-draining condition.

### **3.3 PIPING INSTALLATION**

- A. General Locations and Arrangements: Drawing plans and details indicate general location and arrangement of underground storm drainage piping. Location and arrangement of piping layout take design considerations into account. Install piping as indicated, to extent practical. Where specific installation is not indicated, follow piping manufacturer's written instructions.
- B. Install piping at low point, true to grades and alignment indicated with unbroken continuity of invert. Place bell ends of piping facing upstream. Install gaskets, seals, sleeves, and couplings according to manufacturer's written instructions for use of lubricants, cements, and other installation requirements.
- C. Install piping free of sags and bends.
- D. Use fittings for changes in direction and branch connections unless indicated otherwise.
- E. Install proper size increasers, reducers, and couplings where different sizes or materials of pipes and fittings are connected. Reducing size of piping in direction of flow is prohibited.

- F. Tunneling: Install pipe under streets or other obstructions that cannot be disturbed by tunneling, jacking, or a combination of both.
- G. Install gravity-flow, non-pressure drainage piping according to the following:
  - 1. Install piping pitched down in direction of flow, at slope indicated, but in no case less than 0.3 percent.
  - 2. Install piping at elevations and inverts indicated, but in no case with less than 18-inch cover.
  - 3. Install PVC storm drain piping according to ASTM D 2321 and ASTM F 1668.
- H. Clear interior of piping of dirt and superfluous material as work progresses. Maintain swab or drag in piping, and pull past each joint as it is completed. Place plug in end of incomplete piping at end of day and when work stops.

### **3.4 PIPE JOINT CONSTRUCTION**

- A. Join gravity-flow, non-pressure drainage piping according to the following:
  - 1. Join PVC storm drainage piping according to ASTM D 2321 and ASTM D 3034 for elastomeric-seal joints or ASTM D 3034 for elastomeric gasket joints.
  - 2. Join dissimilar pipe materials with pressure-type couplings.

### **3.5 DRAINAGE INLET AND CATCH BASIN INSTALLATION**

- A. Install drainage inlets at locations indicated on plans.
- B. Set drain frames and covers with tops flush with pavement surface.
- C. Fasten grates to drains.

### **3.6 SUBDRAIN INSTALLATION**

- A. Install subdrains at locations indicated.
- B. Assemble pipes to slope down toward drain outlets.
- C. Install perforated pipes with holes facing down.

### **3.7 CONCRETE PLACEMENT**

- A. Place cast-in-place concrete according to ACI 318/318R.

### 3.8 CONNECTIONS

- A. Make connections to existing storm drainage piping.
  - 1. Use commercially manufactured wye fittings for piping branch connections. Remove section of existing pipe; install wye fitting into existing piping; and encase entire wye fitting, plus 6-inch overlap, with not less than 6-inches of concrete with 28-day compressive strength of 3000 psi.
  - 2. Protect existing piping to prevent concrete or debris from entering while making tap connections. Remove debris or other extraneous material that may accumulate.

### 3.9 IDENTIFICATION

- A. Refer to Section 31 2333 "Trenching and Backfill" for continuous underground warning tape installed over underground storm drainage piping.

### 3.10 FIELD QUALITY CONTROL

- A. Inspect interior of piping to determine whether line displacement or other damage has occurred. Inspect after approximately 24 inches of backfill is in place, and again at completion of Project.
  - 1. Submit separate reports for each system inspection.
  - 2. Defects requiring correction include the following:
    - (a) Alignment: Less than full diameter of inside of pipe is visible between structures.
    - (b) Deflection: Flexible piping with deflection that prevents passage of ball or cylinder of size not less than 92.5 percent of piping diameter.
    - (c) Crushed, broken, cracked, or otherwise damaged piping.
    - (d) Infiltration: Water leakage into piping.
    - (e) Exfiltration: Water leakage from or around piping.
  - 3. Replace defective piping using new materials, and repeat inspections until defects are within allowances specified.
  - 4. Re-inspect and repeat procedure until results are satisfactory.

- B. Test new piping systems, and parts of existing systems that have been altered, extended, or repaired, for leaks and defects.
  - 1. Do not enclose, cover, or put into service before inspection and approval.
  - 2. Test completed piping systems according to authorities having jurisdiction.
  - 3. Schedule tests and inspections by authorities having jurisdiction with at least two working days advance notice.
  - 4. Submit separate report for each test.
- C. Leaks constitute defects that must be repaired.
- D. Replace leaking piping using new materials.

**3.11 CLEANING**

- A. Clean interior of piping of dirt and superfluous materials. Flush with potable water.
- B. Where connecting to existing drain lines, clean existing line from point-of-connection to nearest downstream manhole or catch basin.

**END OF SECTION 33 4000**